



US00D988597S

(12) **United States Design Patent** (10) **Patent No.:** **US D988,597 S**  
**Shami** (45) **Date of Patent:** **\*\* Jun. 6, 2023**

(54) **HAIRDRYER**

(71) Applicant: **FAROUK SYSTEMS, INC.**, Houston, TX (US)

(72) Inventor: **Farouk M. Shami**, Houston, TX (US)

(73) Assignee: **Farouk Systems, Inc.**, Houston, TX (US)

(\*\*) Term: **15 Years**

(21) Appl. No.: **29/774,384**

(22) Filed: **Mar. 16, 2021**

**Related U.S. Application Data**

(60) Continuation of application No. 29/747,235, filed on Aug. 20, 2020, now Pat. No. Des. 914,974, which is a division of application No. 29/682,786, filed on Mar. 7, 2019, now Pat. No. Des. 897,035.

(51) **LOC (14) Cl.** ..... **28-03**

(52) **U.S. Cl.**  
USPC ..... **D28/13**

(58) **Field of Classification Search**  
USPC ..... D28/12-19; D8/29.1  
CPC ..... A45D 20/00; A45D 20/04; A45D 20/08;  
A45D 20/10; A45D 20/12; A45D  
2020/128

See application file for complete search history.

(56) **References Cited**

**U.S. PATENT DOCUMENTS**

D250,722	S	*	1/1979	Cousins	.....	D28/16
D251,989	S	*	5/1979	Rizzuto	.....	D28/13
D253,012	S	*	9/1979	Rakocy	.....	D28/16
D254,328	S	*	2/1980	Benty	.....	D28/16
D254,451	S	*	3/1980	Battaglia	.....	D28/13
D257,067	S	*	9/1980	Muller	.....	D28/13
D257,492	S	*	11/1980	Cousins	.....	D28/13
5,279,048	A	*	1/1994	Lawall	.....	A45D 20/12 34/91

\* cited by examiner

*Primary Examiner* — Zenia I Bennett

(74) *Attorney, Agent, or Firm* — Polsinelli PC

(57) **CLAIM**

I claim the ornamental design for a hairdryer, as shown and described.

**DESCRIPTION**

FIG. 1 is a front-right perspective view of a hairdryer, showing my new design;

FIG. 2 is a rear-left perspective view thereof;

FIG. 3 is a front elevational view thereof;

FIG. 4 is a rear elevational view thereof;

FIG. 5 is a right side elevational view thereof;

FIG. 6 is a left side elevational view thereof;

FIG. 7 is a top plan view thereof; and,

FIG. 8 is a bottom plan view thereof.

The broken lines depict portions of the hairdryer that form no part of the claimed design.

**1 Claim, 6 Drawing Sheets**

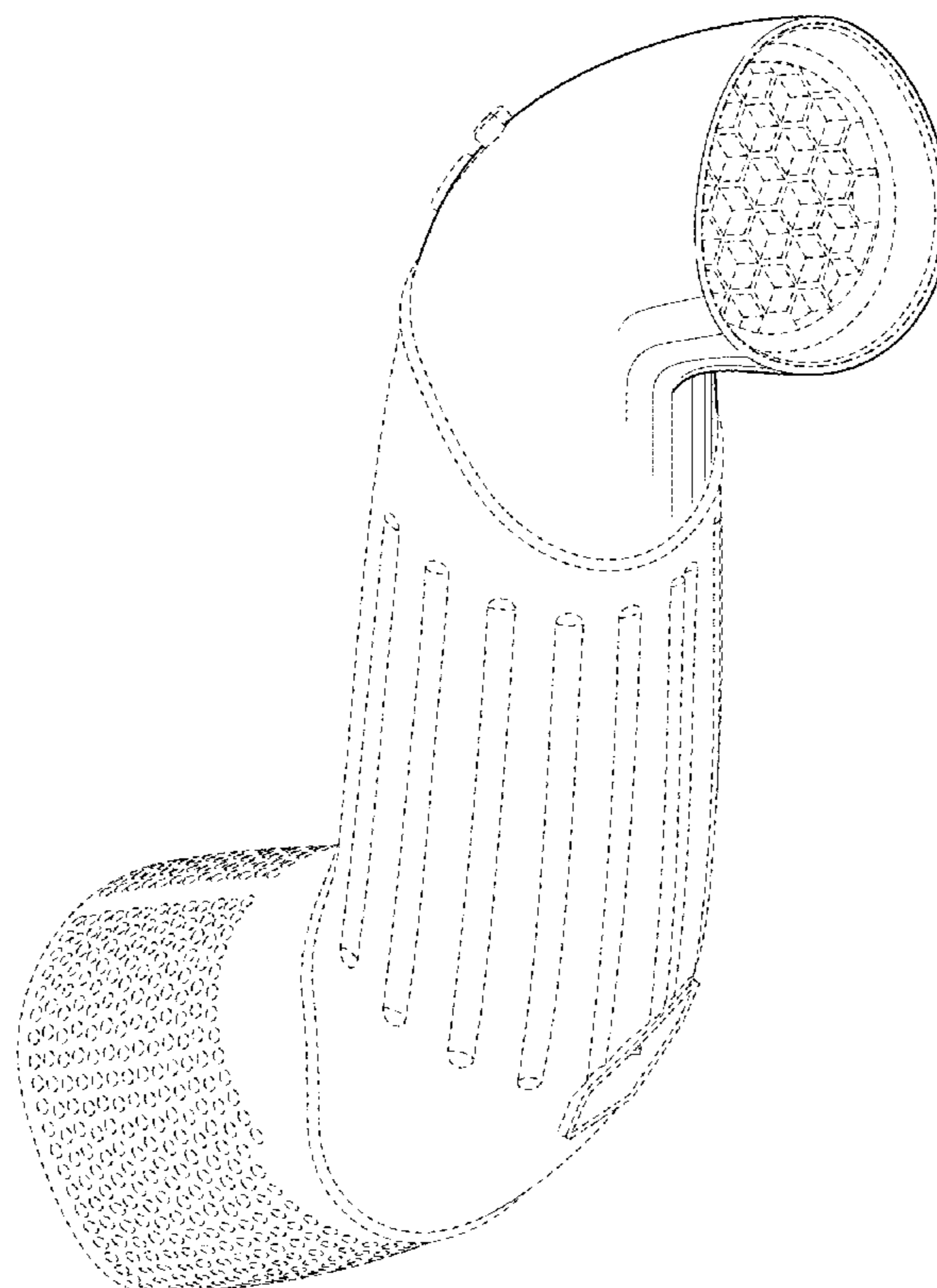

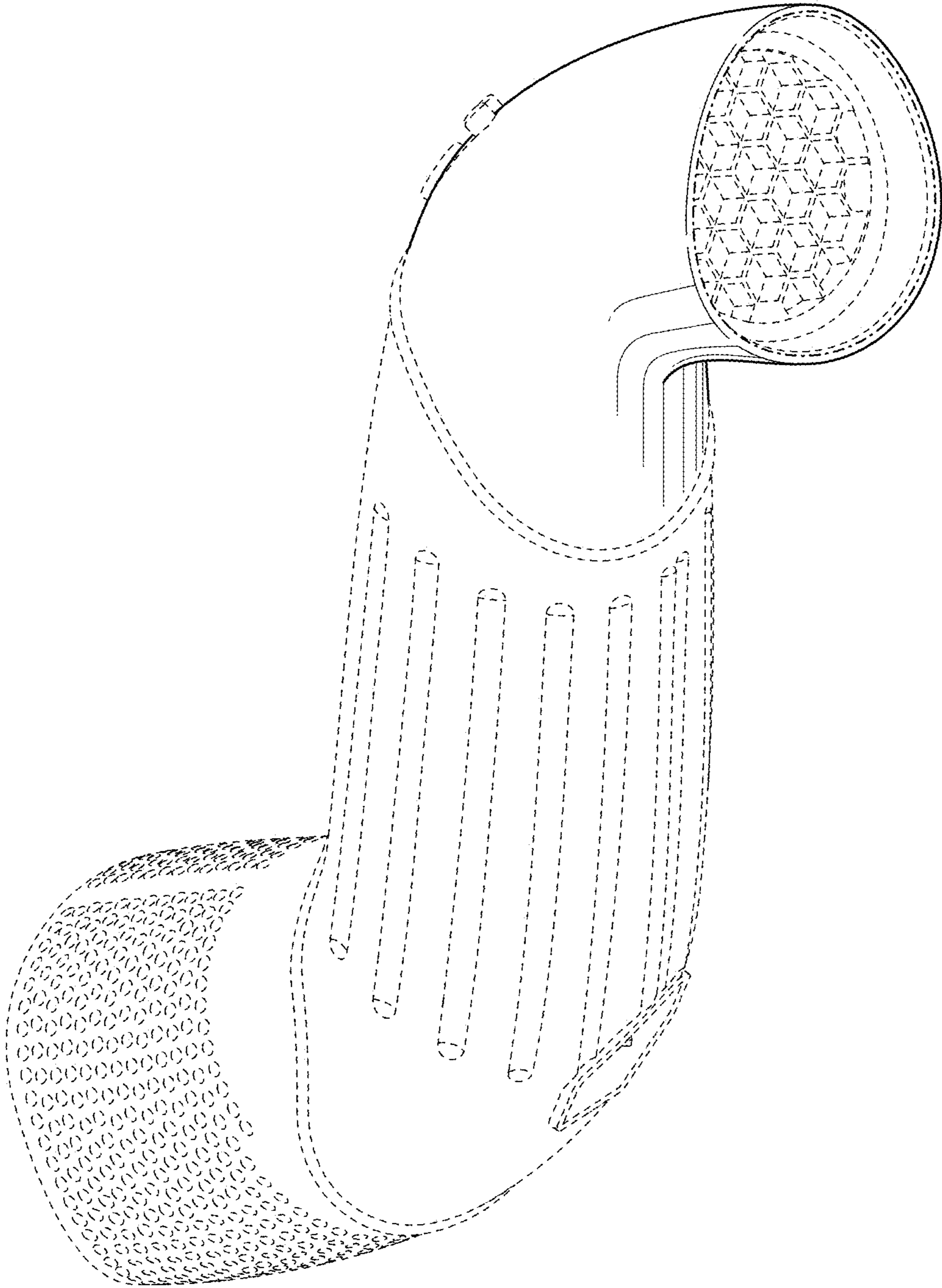

FIG. 1

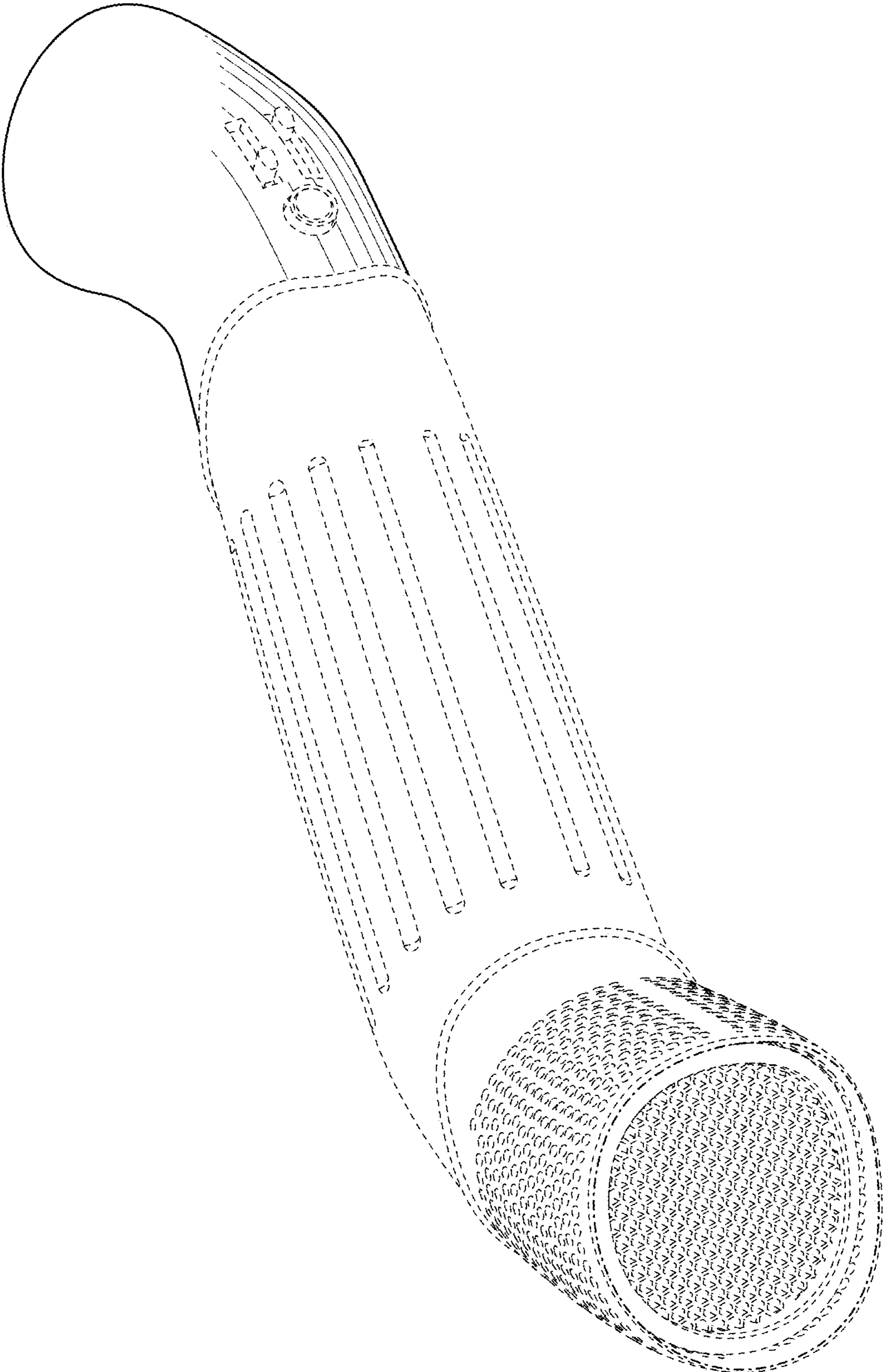

FIG. 2



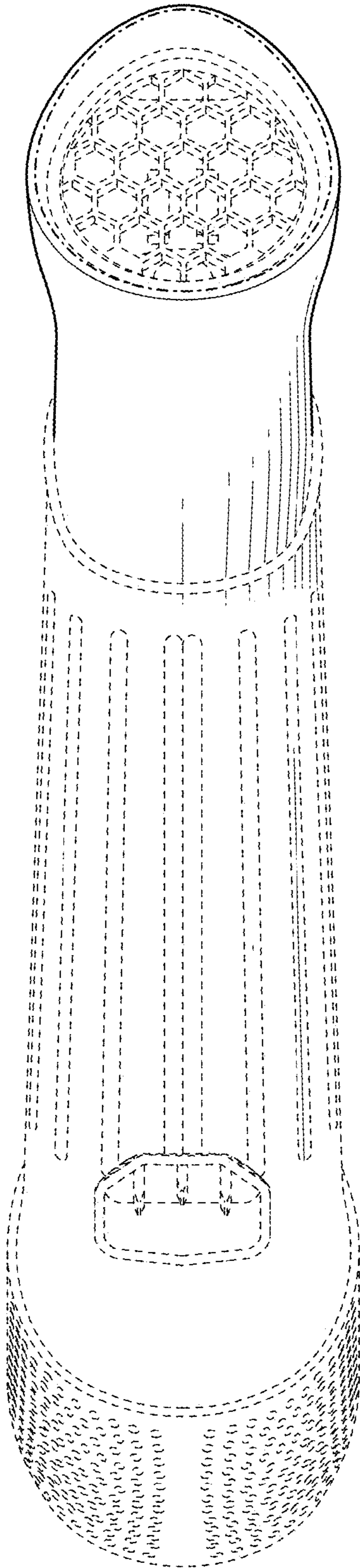

FIG. 3

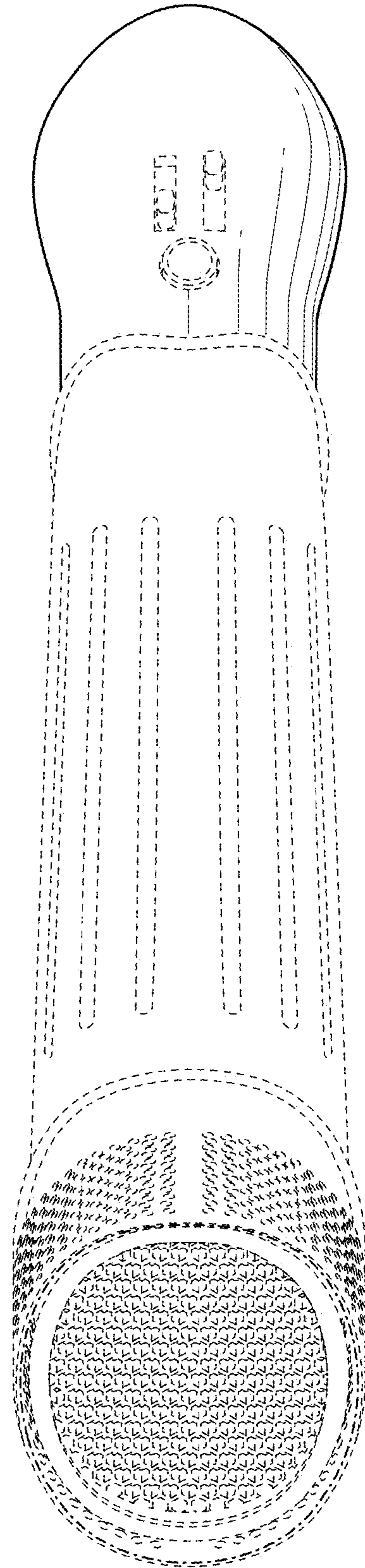

FIG. 4

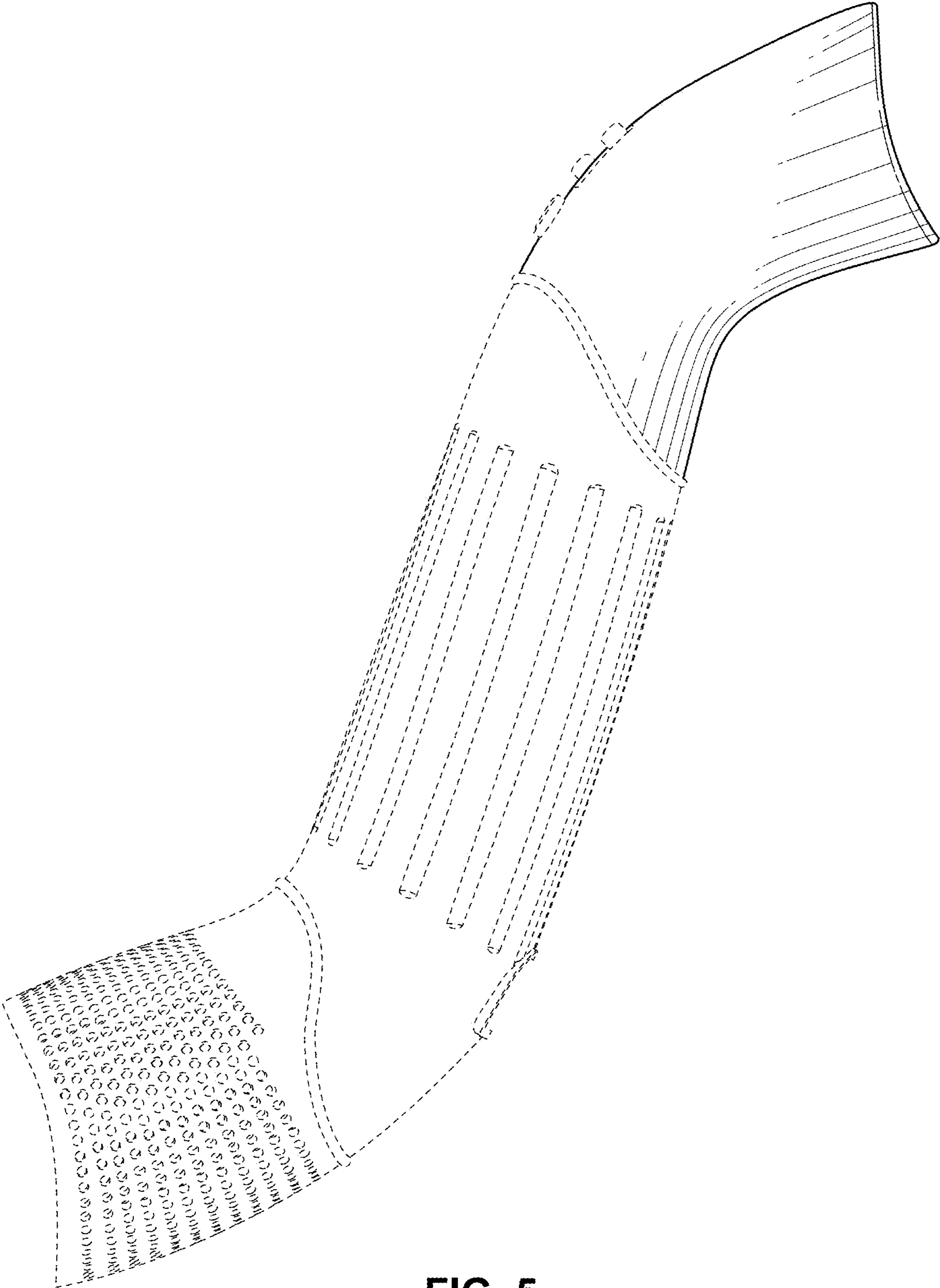

FIG. 5

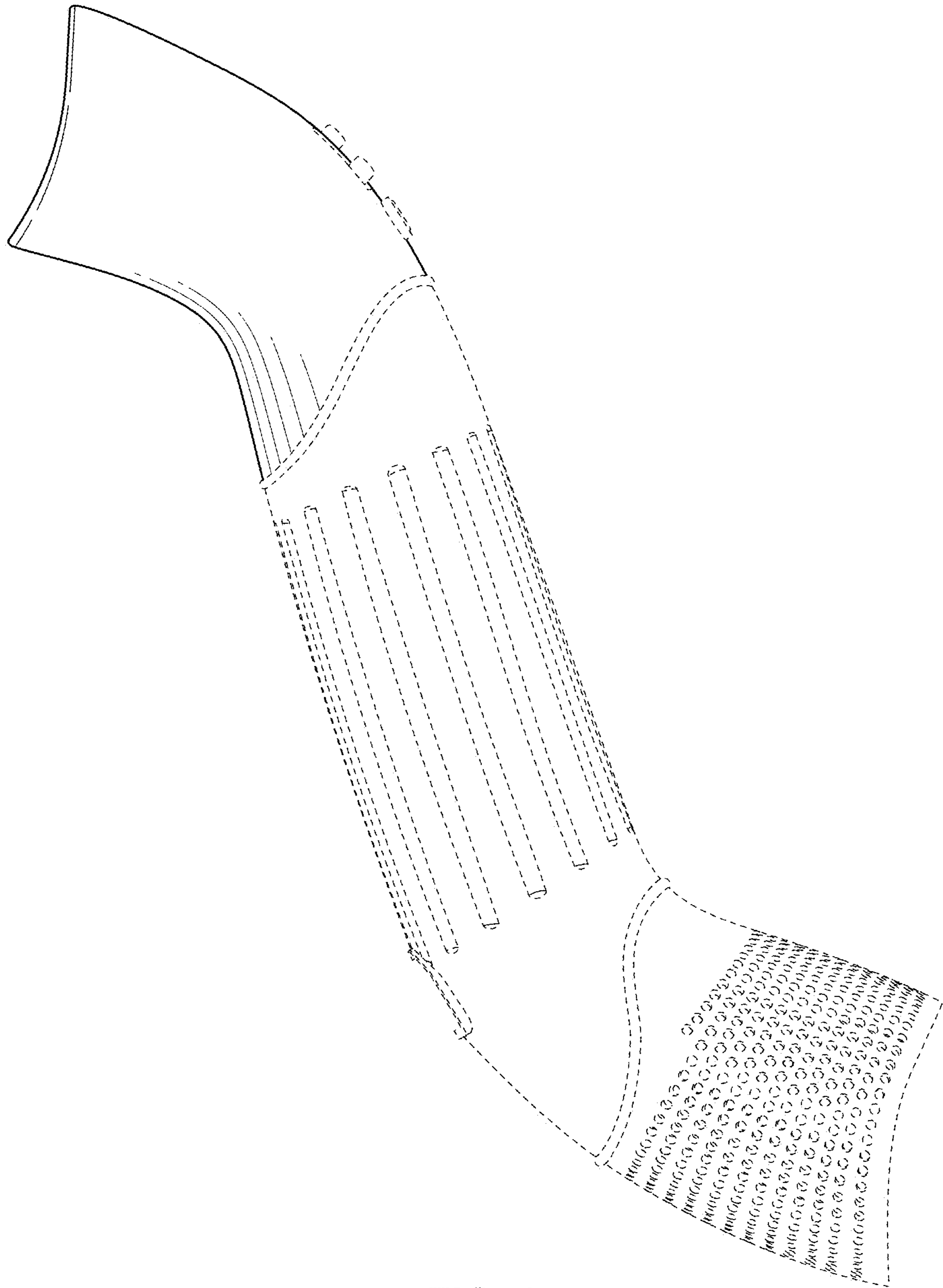

FIG. 6

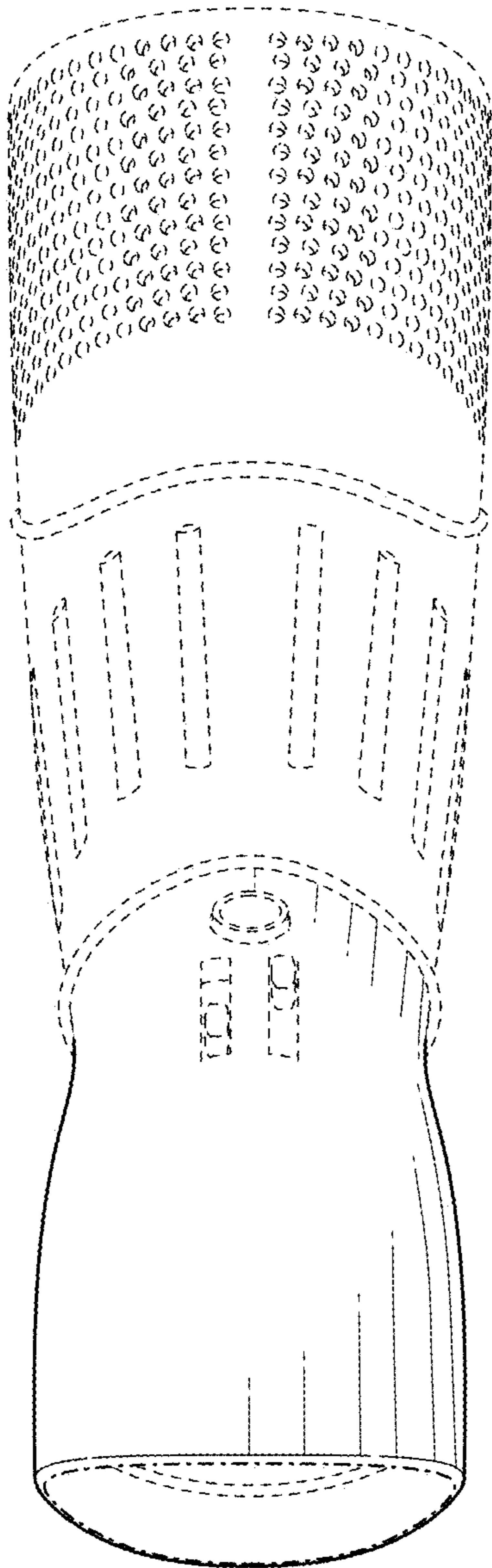

FIG. 7

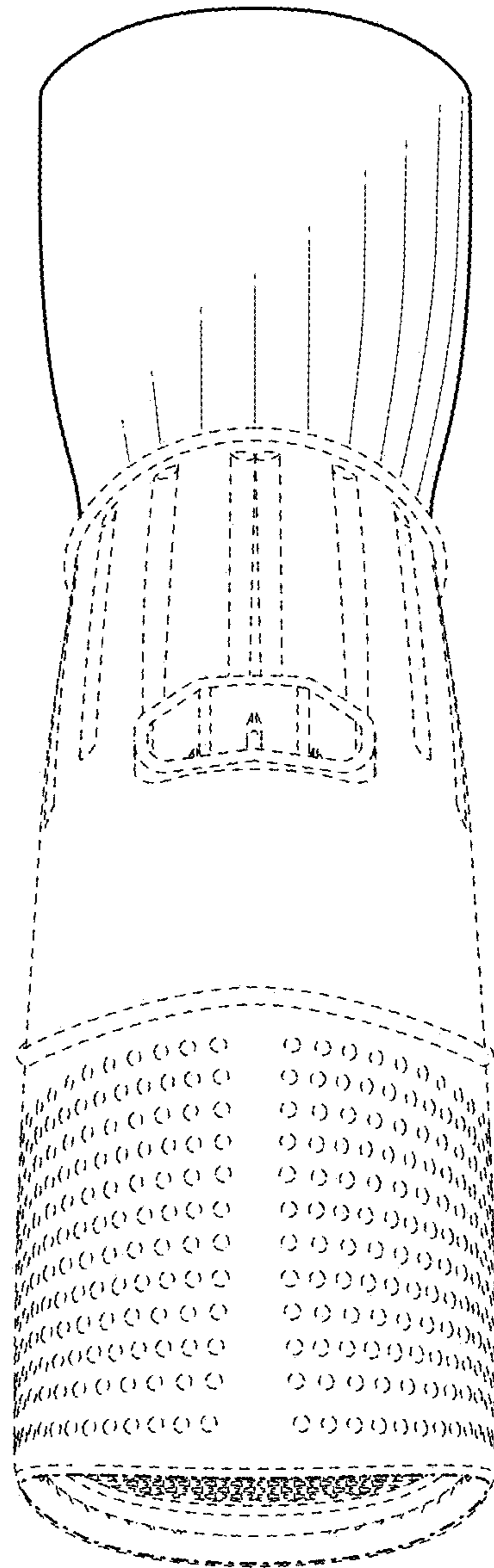

FIG. 8