



US00D988593S

(12) **United States Design Patent** (10) **Patent No.:** **US D988,593 S**
Lim (45) **Date of Patent:** **** Jun. 6, 2023**

(54) **COSMETIC APPLICATOR**

D762,474 S * 8/2016 Chung D9/449
9,681,728 B2 * 6/2017 Jung B65D 35/44

(71) Applicant: **YONWOO CO., LTD.**, Incheon (KR)

* cited by examiner

(72) Inventor: **Sung Taek Lim**, Incheon (KR)

Primary Examiner — Zenia I Bennett

(73) Assignee: **YONWOO CO., LTD.**, Incheon (KR)

(74) *Attorney, Agent, or Firm* — Bridgeway IP Law Group, PLLC; Sang Ho Lee; Hyun Woo Shin

(**) Term: **15 Years**

(57) **CLAIM**

(21) Appl. No.: **29/781,819**

I claim the ornamental design for a cosmetic applicator, as shown and described.

(22) Filed: **Apr. 30, 2021**

DESCRIPTION

(30) **Foreign Application Priority Data**

Nov. 23, 2020 (KR) 30-2020-0056724
Nov. 23, 2020 (KR) 30-2020-0056725

FIG. 1 is a perspective view of a cosmetic applicator, showing my new design;

(51) **LOC (14) Cl.** **28-03**

FIG. 2 is a front elevation view thereof;

(52) **U.S. Cl.**
USPC **D28/7**

FIG. 3 is a rear elevation view thereof;

(58) **Field of Classification Search**
USPC D28/4, 7, 9
CPC A45D 40/24; A45D 40/26; A45D 40/261
See application file for complete search history.

FIG. 4 is a left side elevation view thereof;

FIG. 5 is a right side elevation view thereof;

FIG. 6 is a top plan view thereof;

FIG. 7 is a bottom plan view thereof;

FIG. 8 is an exploded perspective view thereof;

FIG. 9 is a perspective view of a tip portion of the cosmetic applicator;

FIG. 10 is a front elevation view thereof;

FIG. 11 is a rear elevation view thereof;

FIG. 12 is a left side elevation view thereof;

FIG. 13 is a right side elevation view thereof;

FIG. 14 is a top plan view thereof;

FIG. 15 is a bottom plan view thereof; and,

FIG. 16 is an exploded perspective view thereof.

The broken lines in the drawings show portions of the cosmetic applicator which form no part of the claimed design.

(56) **References Cited**

U.S. PATENT DOCUMENTS

D203,421 S * 1/1966 Buxbaum D9/697
D377,978 S * 2/1997 Haber D24/119
5,951,185 A * 9/1999 Kingsford B05B 11/0035
401/101
D423,355 S * 4/2000 Loeb D9/447
D668,541 S * 10/2012 McCoy D9/447
9,155,372 B2 * 10/2015 Gieux A45D 34/04
9,215,921 B2 * 12/2015 Thiebaut A45D 40/26

1 Claim, 12 Drawing Sheets

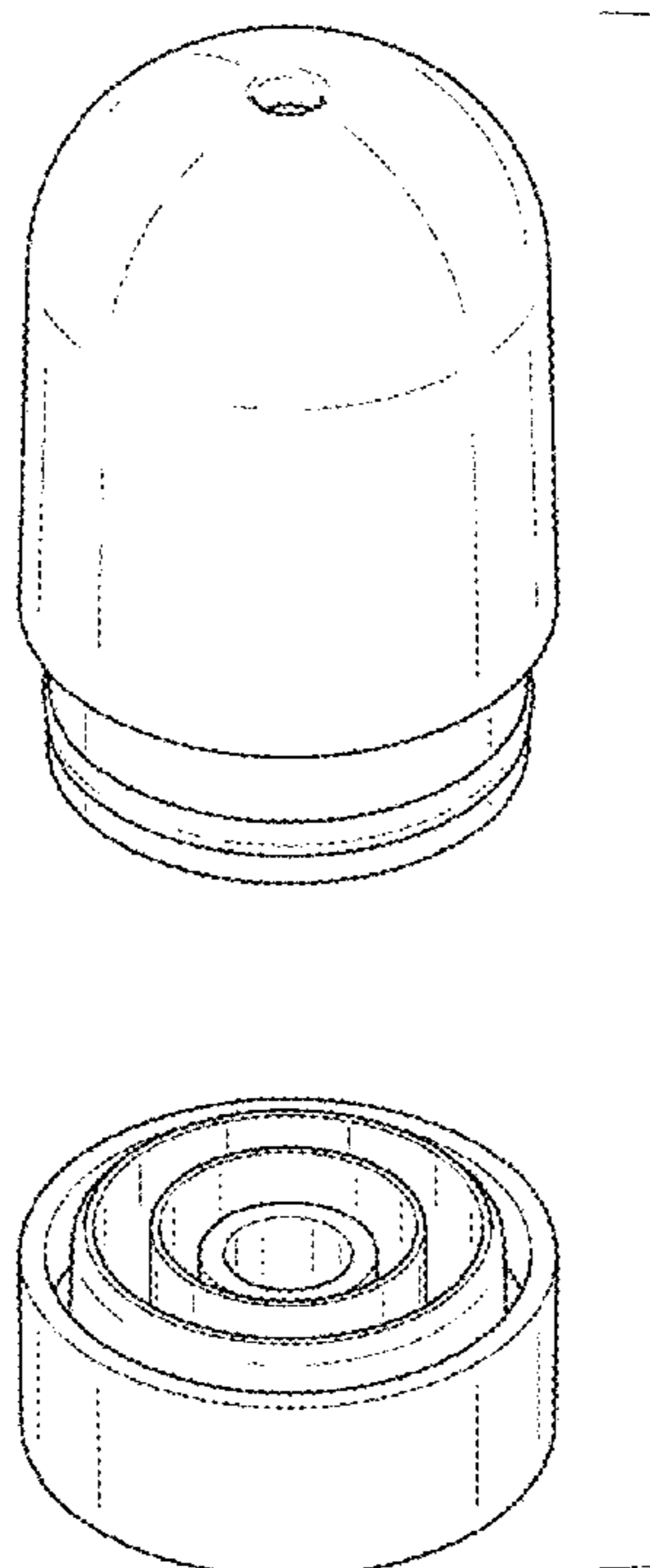

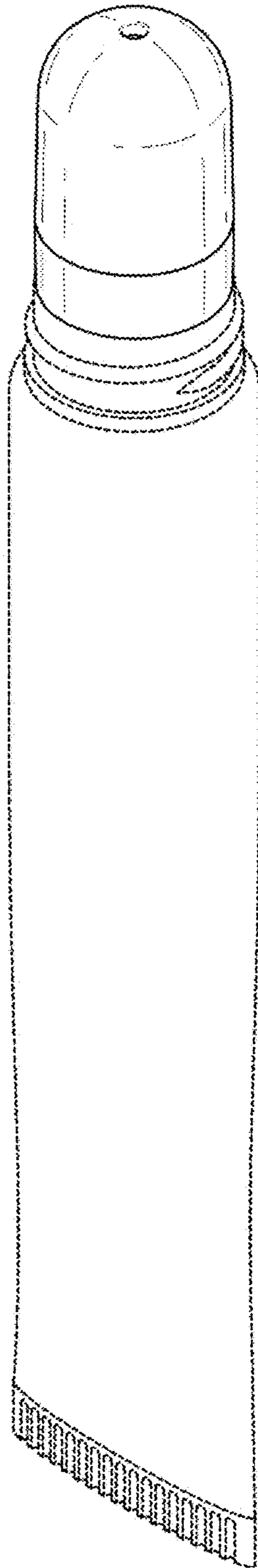

FIG. 1

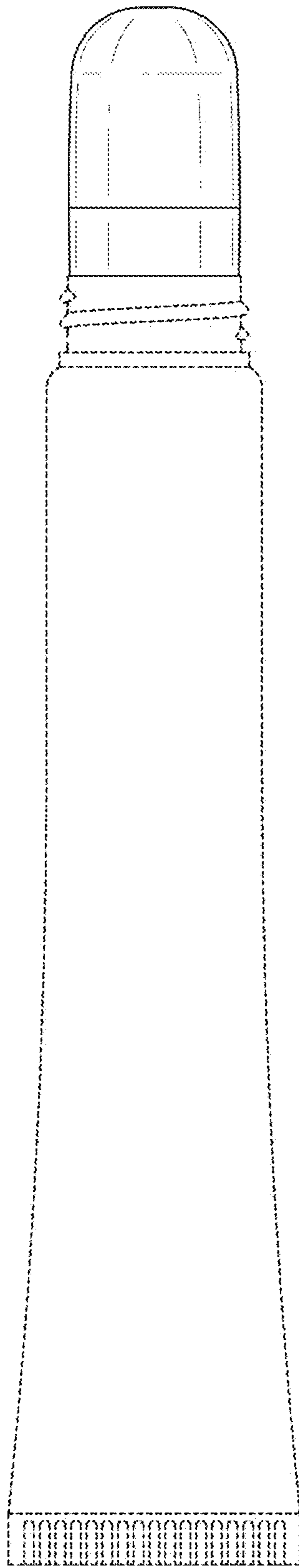

FIG. 2

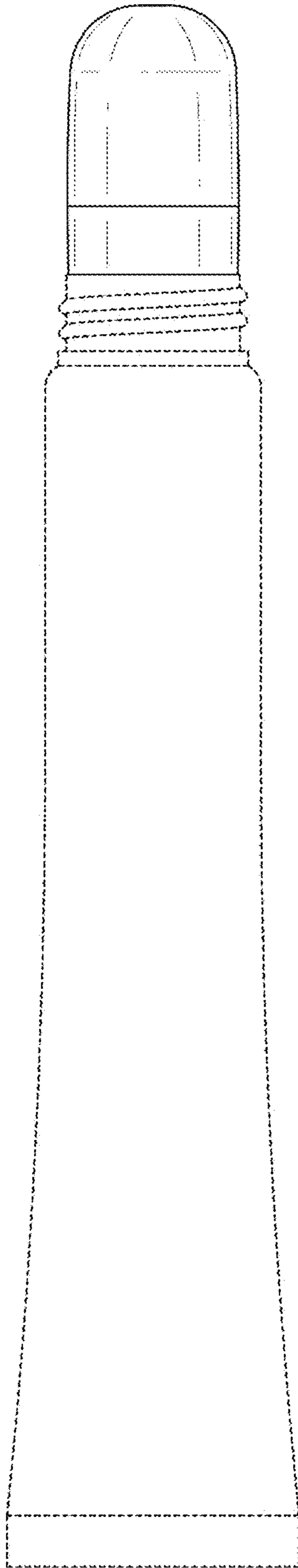

FIG. 3

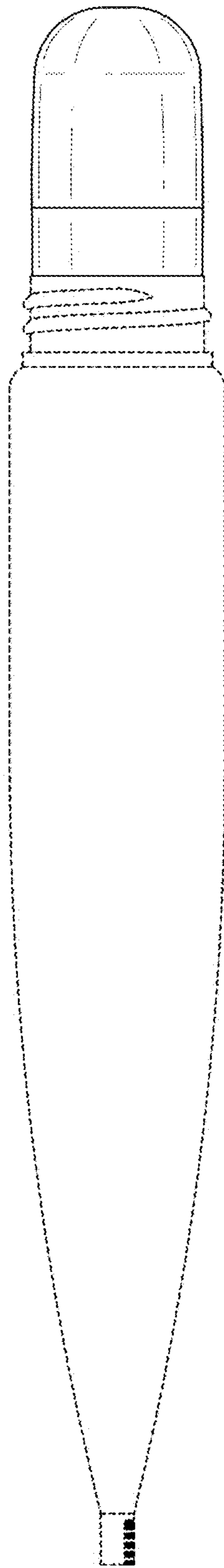

FIG. 4

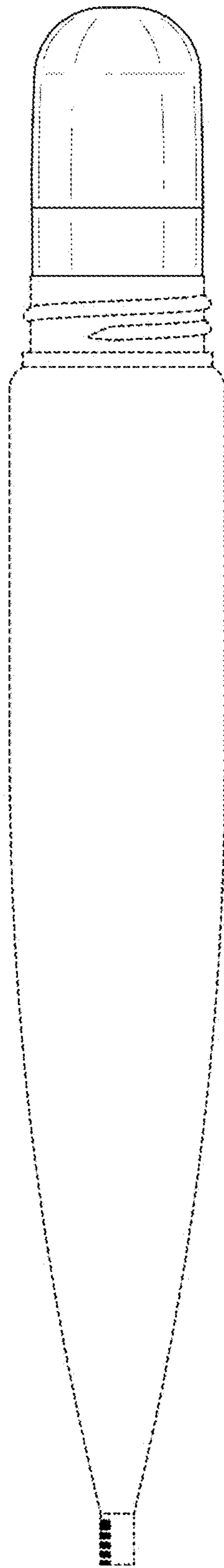

FIG. 5

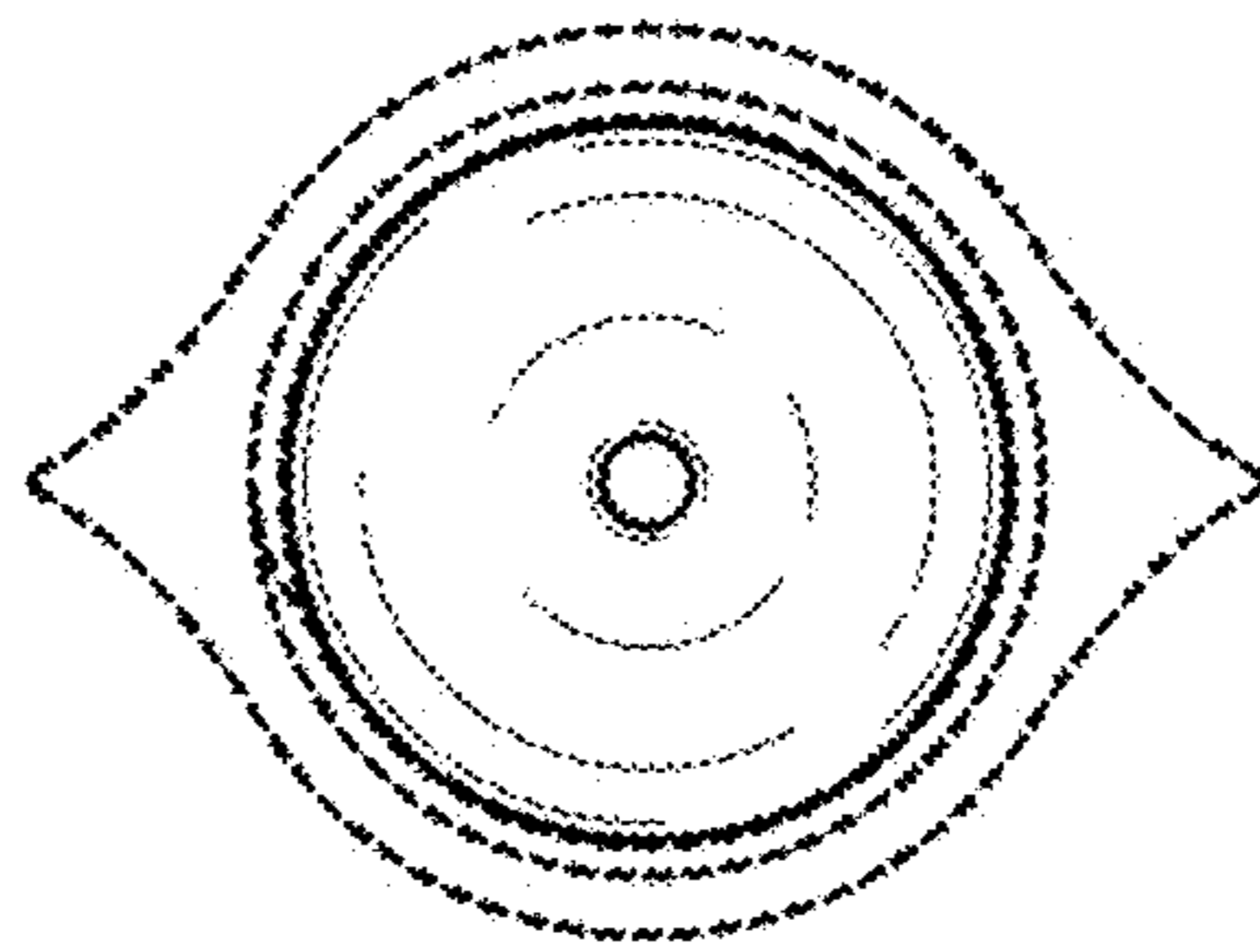

FIG. 6

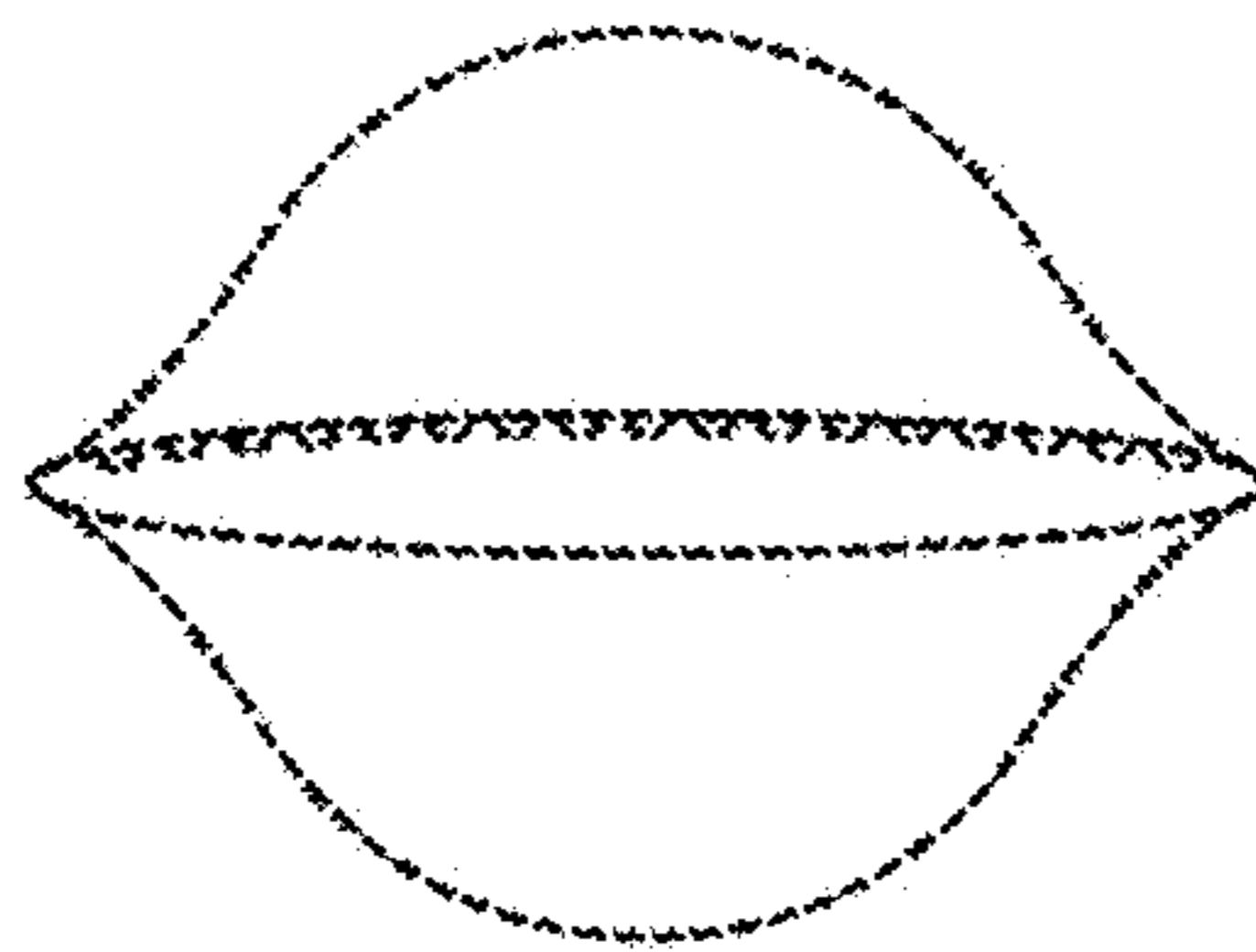

FIG. 7

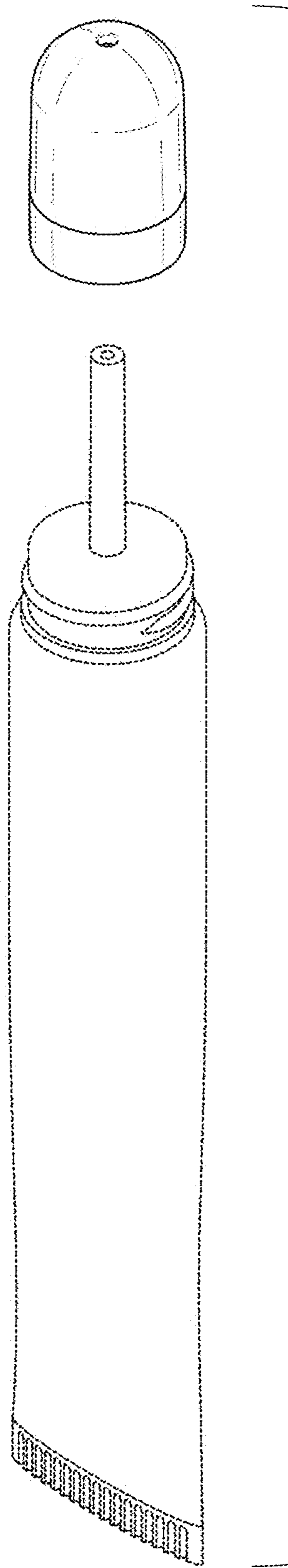

FIG. 8

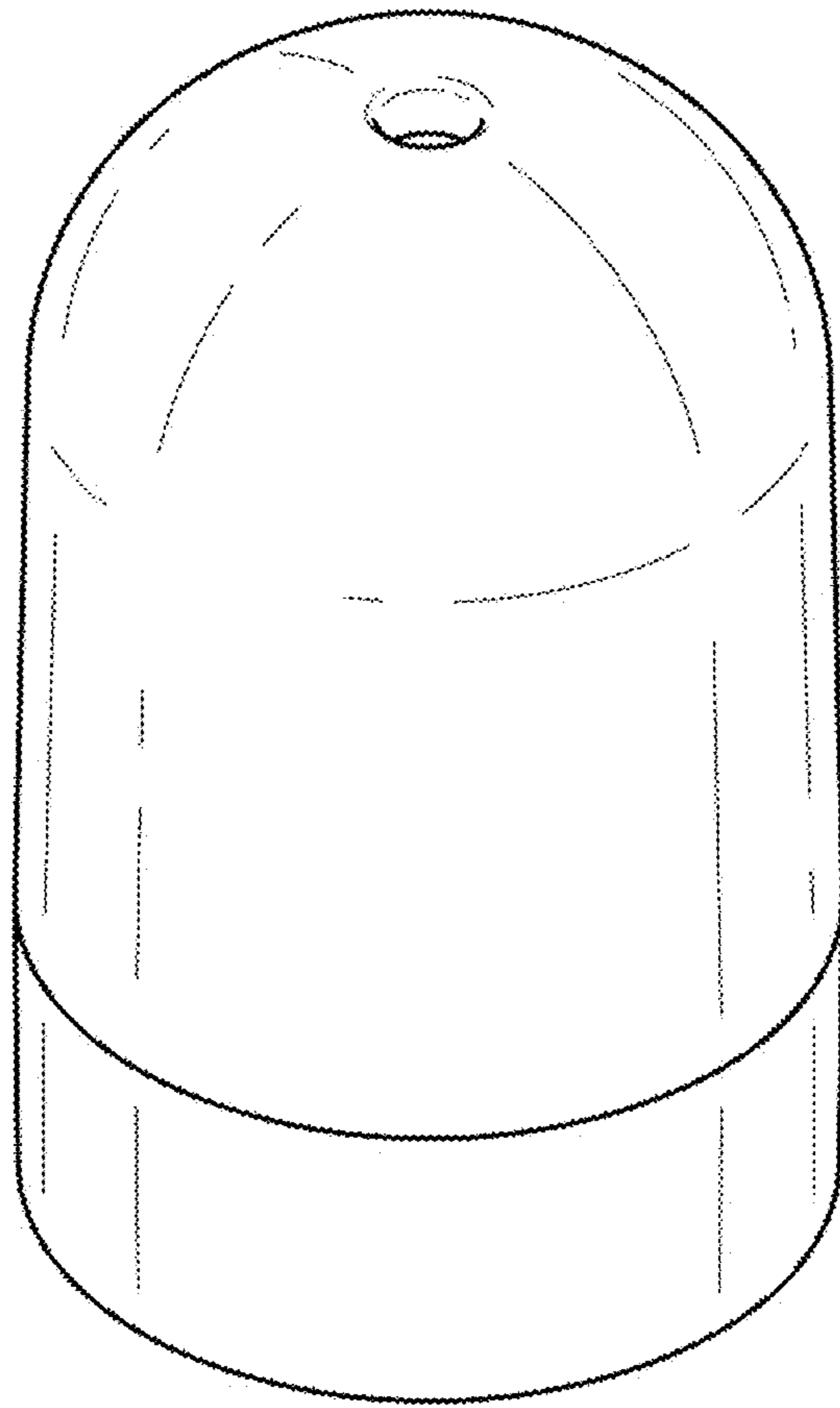

FIG. 9

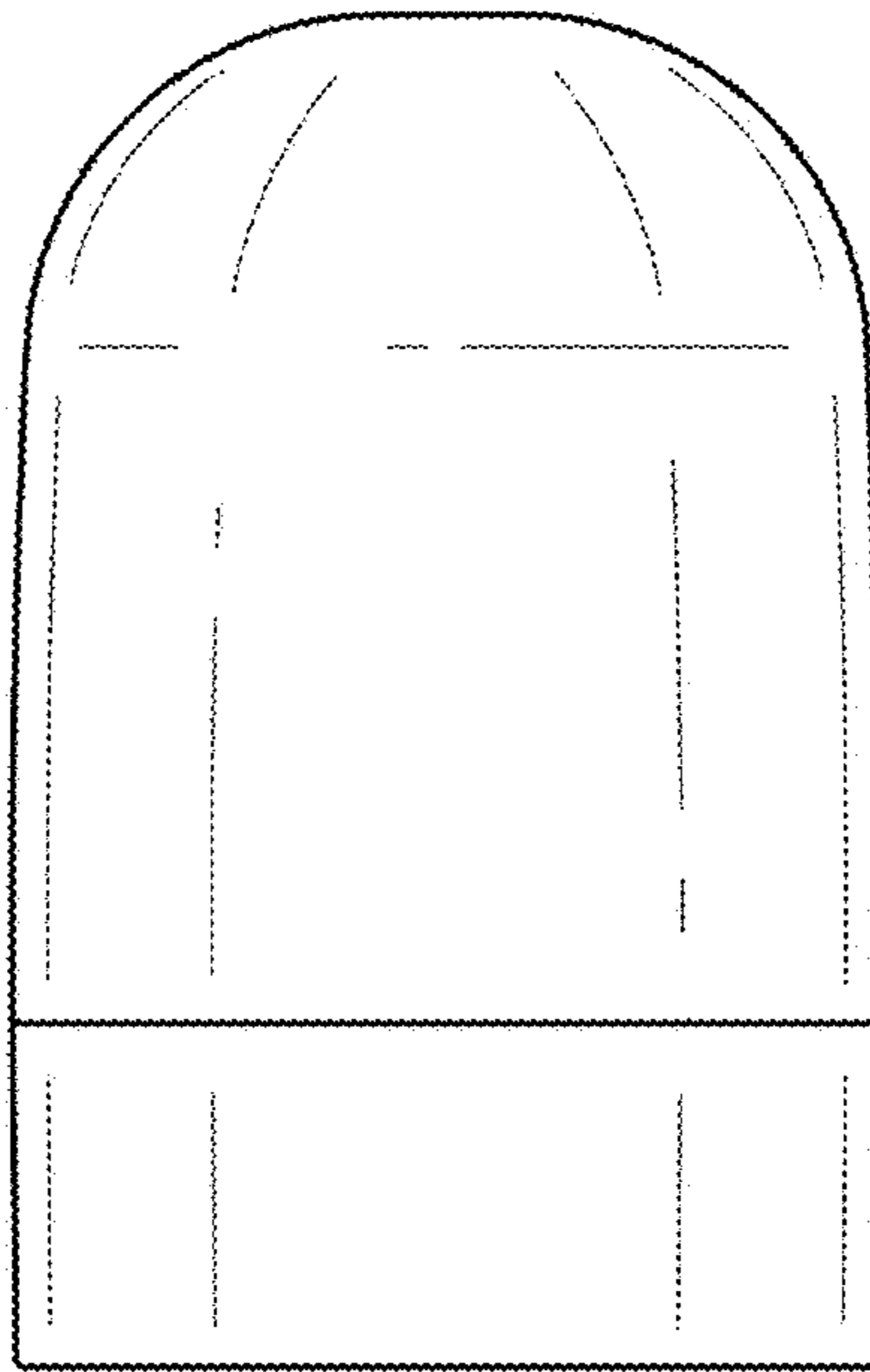

FIG. 10

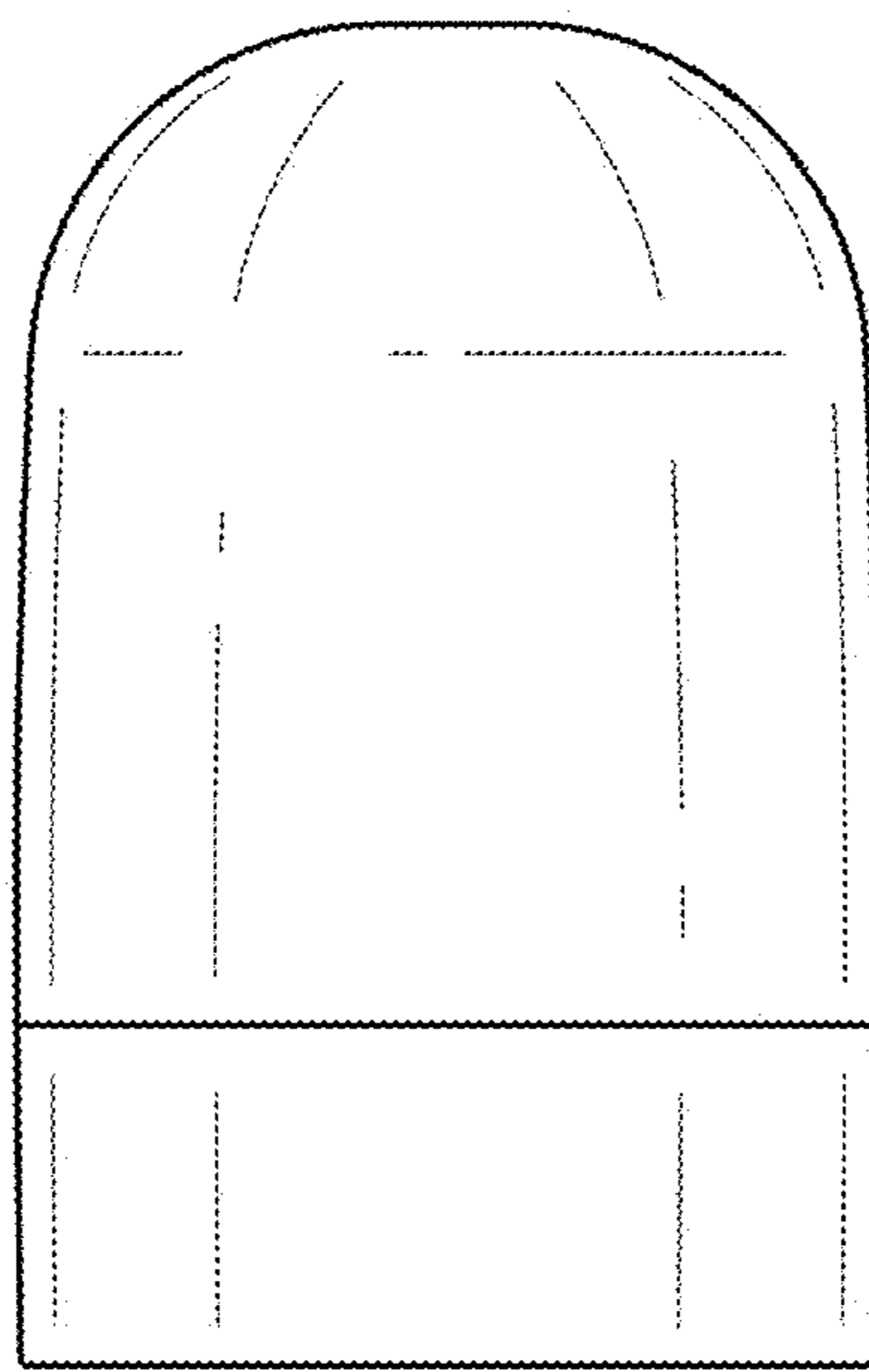

FIG. 11

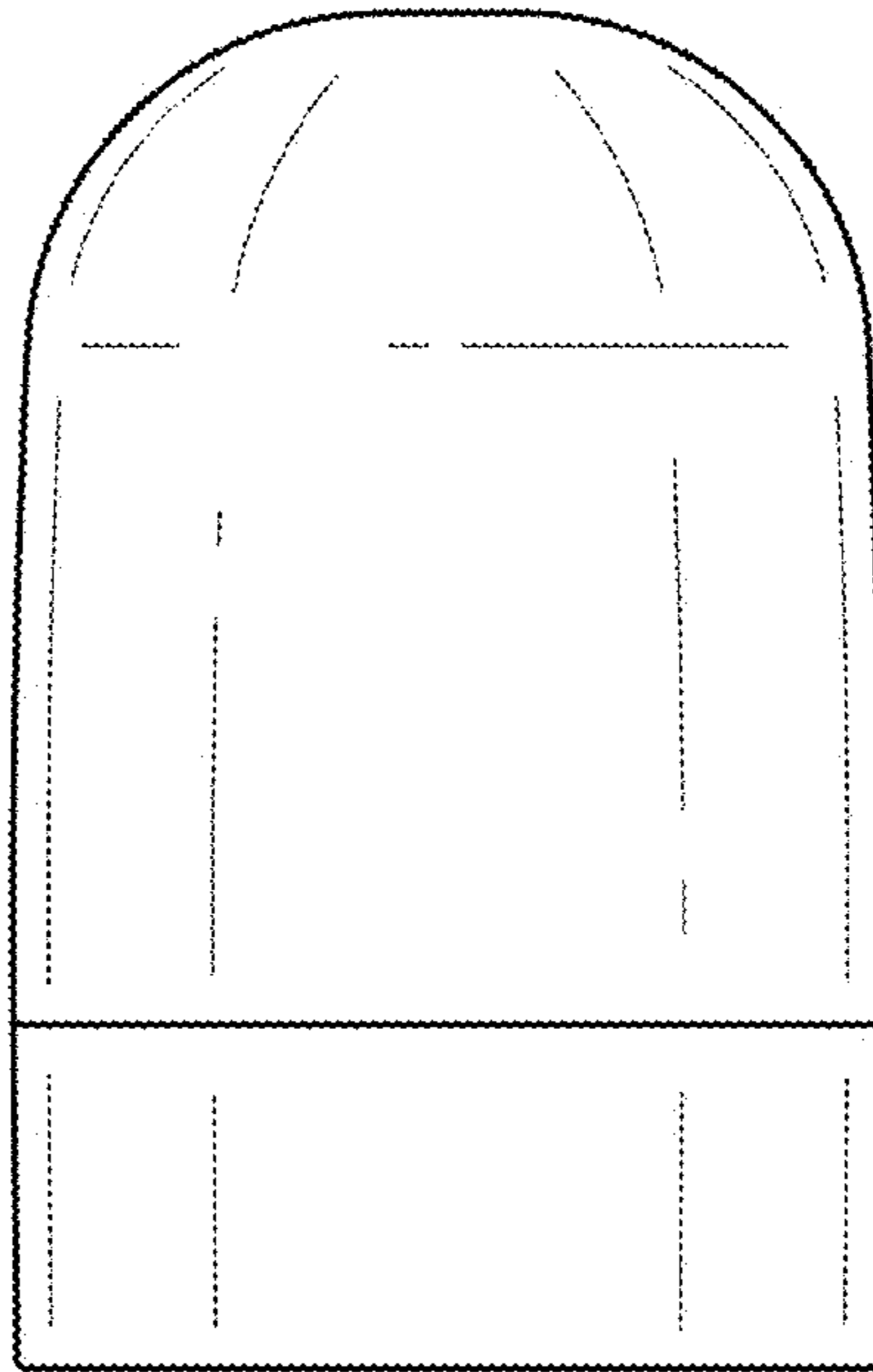

FIG. 12

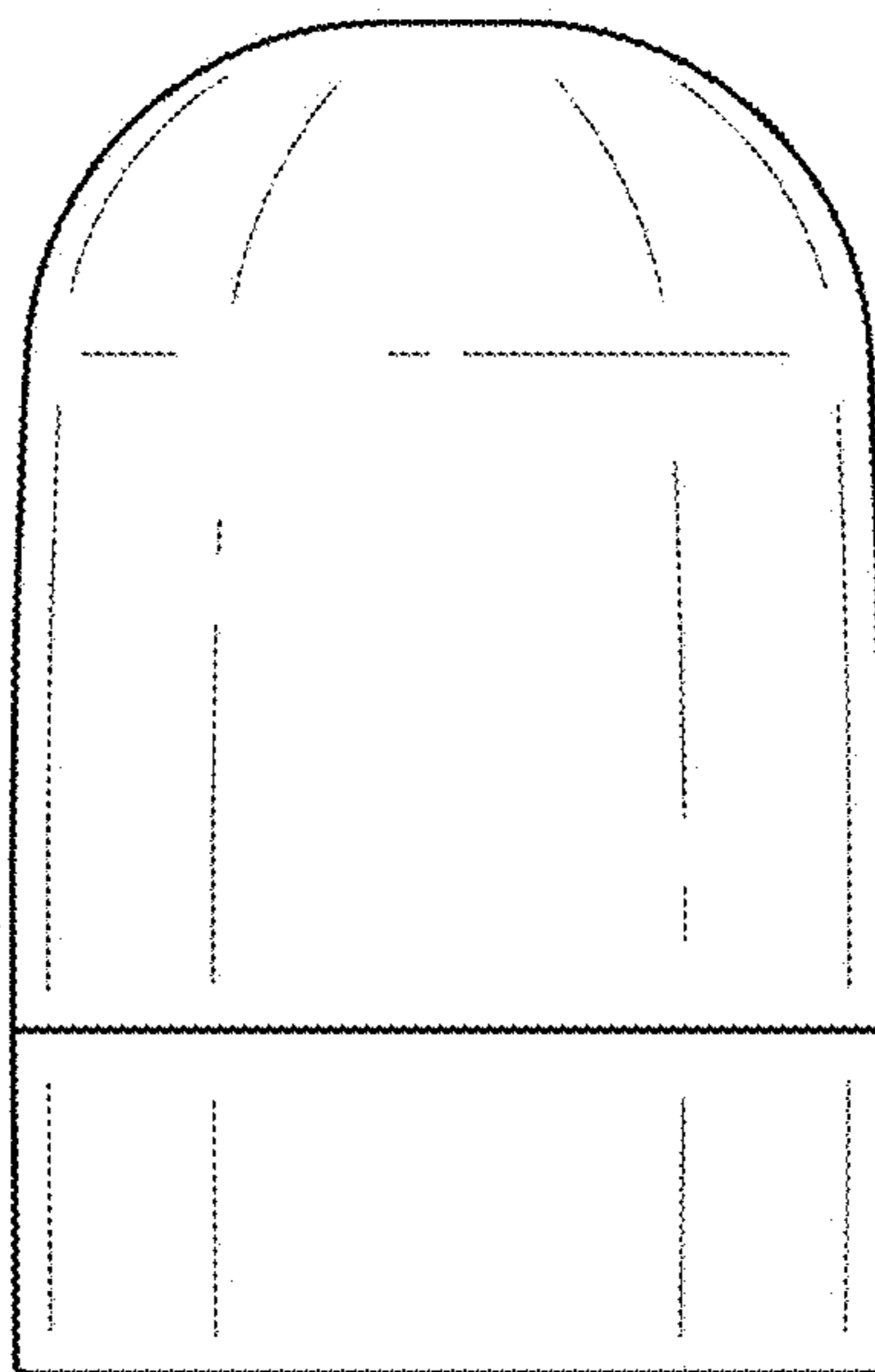

FIG. 13

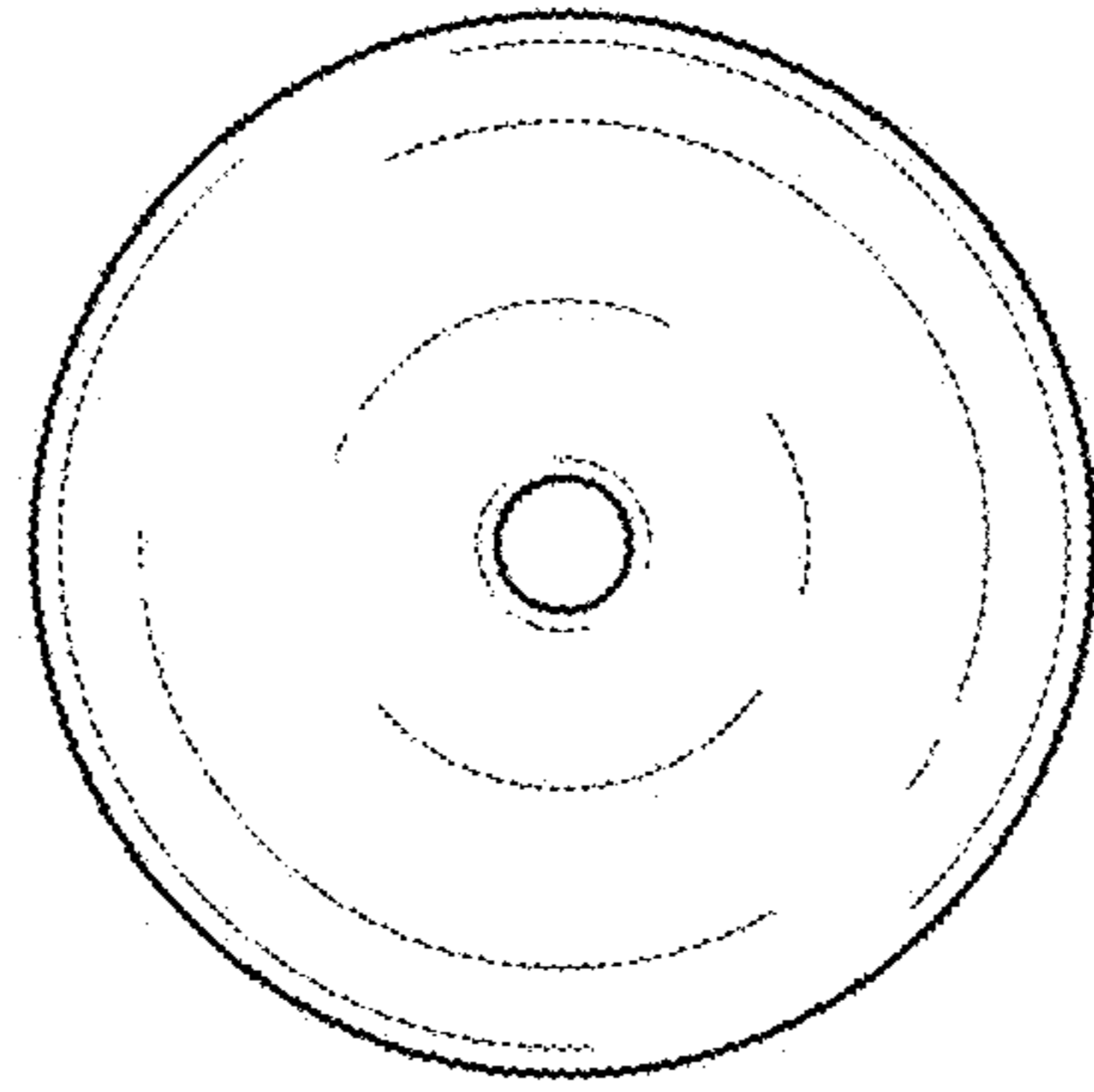

FIG. 14

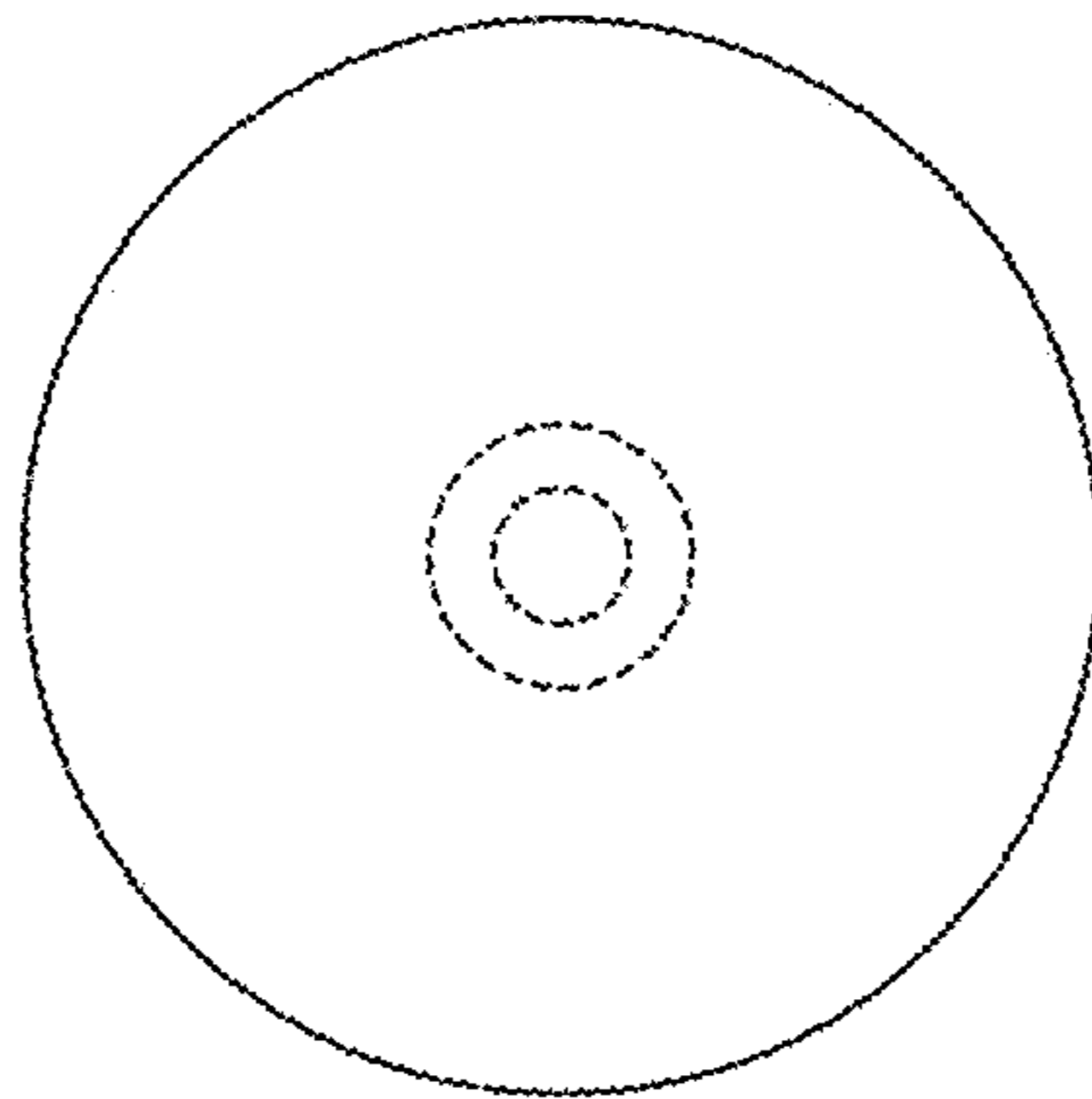

FIG. 15

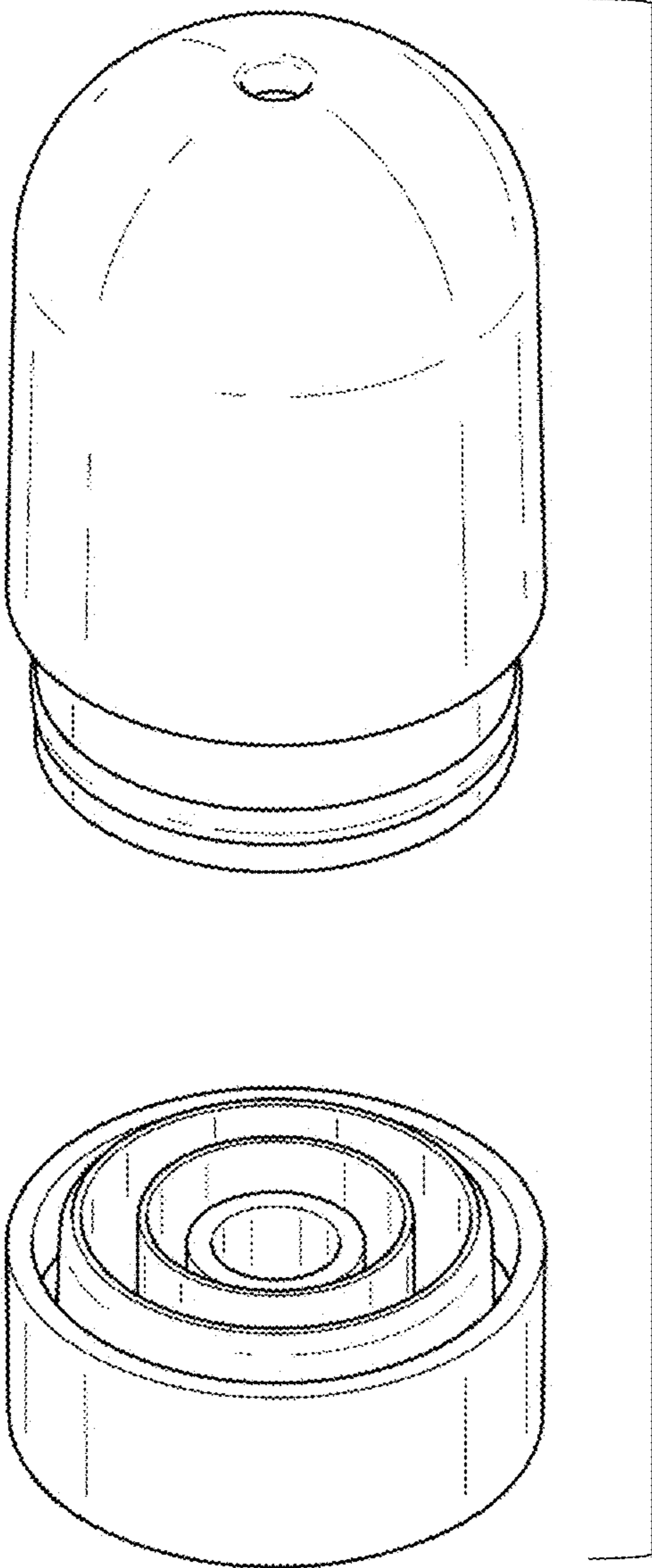

FIG. 16