



US00D988523S

(12) **United States Design Patent** (10) **Patent No.:** **US D988,523 S**
Guo (45) **Date of Patent:** **** Jun. 6, 2023**

(54) **HAIR GROWTH HELMET**
(71) Applicant: **Jinxia Guo**, Xianyou (CN)
(72) Inventor: **Jinxia Guo**, Xianyou (CN)
(**) Term: **15 Years**
(21) Appl. No.: **29/791,205**

D919,187 S * 5/2021 Chen D29/102
2012/0059440 A1* 3/2012 Hamid A61N 5/0617
607/91
2018/0008839 A1* 1/2018 Hamid A61N 5/0617
2022/0117346 A1* 4/2022 Guo A61N 5/067

FOREIGN PATENT DOCUMENTS

CN 306324690 * 2/2021
KR 301097366.0000 * 2/2021

OTHER PUBLICATIONS

iRestore Essential Lazer Hair Growth System, Amazon.com, reviewed Jun. 11, 2018, date retrieved Aug. 19, 2022—29791205—https://www.amazon.com/iRestore-Laser-Hair-Growth-System/dp/B01B29PCUU/ref=psdc_10898755011_t1_B07M5X4D3P?th=1 (Year: 2018).*

(Continued)

Primary Examiner — Nicole C Shiflet
Assistant Examiner — Danielle Nichole Bowly
(74) *Attorney, Agent, or Firm* — Rumit Ranjit Kanakia

(22) Filed: **Jan. 5, 2022**
(51) **LOC (14) Cl.** **24-01**
(52) **U.S. Cl.**
USPC **D24/200**
(58) **Field of Classification Search**
USPC D24/200, 201, 207, 215; D29/102, 107
CPC A63B 23/0222; A61N 2005/0647; A61N
5/0617
See application file for complete search history.

(57) **CLAIM**

The ornamental design for a hair growth helmet, as shown and described.

DESCRIPTION

FIG. 1 is a first perspective view of a hair growth helmet showing my new design;
FIG. 2 is a second perspective view thereof;
FIG. 3 is a front view thereof;
FIG. 4 is a back view thereof;
FIG. 5 is a left side view thereof;
FIG. 6 is a right side view thereof;
FIG. 7 is a top view thereof; and,
FIG. 8 is a bottom view thereof.
The broken lines shown in the drawings depict portions of the hair growth helmet that form no part of the claim.

1 Claim, 8 Drawing Sheets

(56) **References Cited**

U.S. PATENT DOCUMENTS

D100,814 S * 8/1936 Fisken D29/102
3,245,087 A * 4/1966 Marchello A42B 3/003
D29/102
D319,112 S * 8/1991 Broersma D29/102
D348,520 S * 7/1994 Wolf D24/215
D426,032 S * 5/2000 Ho D29/102
D447,287 S * 8/2001 Ho D29/102
D466,651 S * 12/2002 Halstead D29/106
D567,450 S 4/2008 Renfrew
D613,458 S * 4/2010 Righetti D29/102
D655,048 S * 2/2012 Moeller D29/102
D670,440 S * 11/2012 Ho D29/102
D673,329 S * 12/2012 Batsch D29/104
D777,986 S * 1/2017 Petzl D29/102
D853,039 S * 7/2019 Lee D29/102
D854,750 S * 7/2019 O'Connell D29/102
D878,683 S * 3/2020 Axelsson D29/122
D896,977 S 9/2020 Chen
D897,548 S 9/2020 Liu
D910,927 S * 2/2021 Devitt D29/102

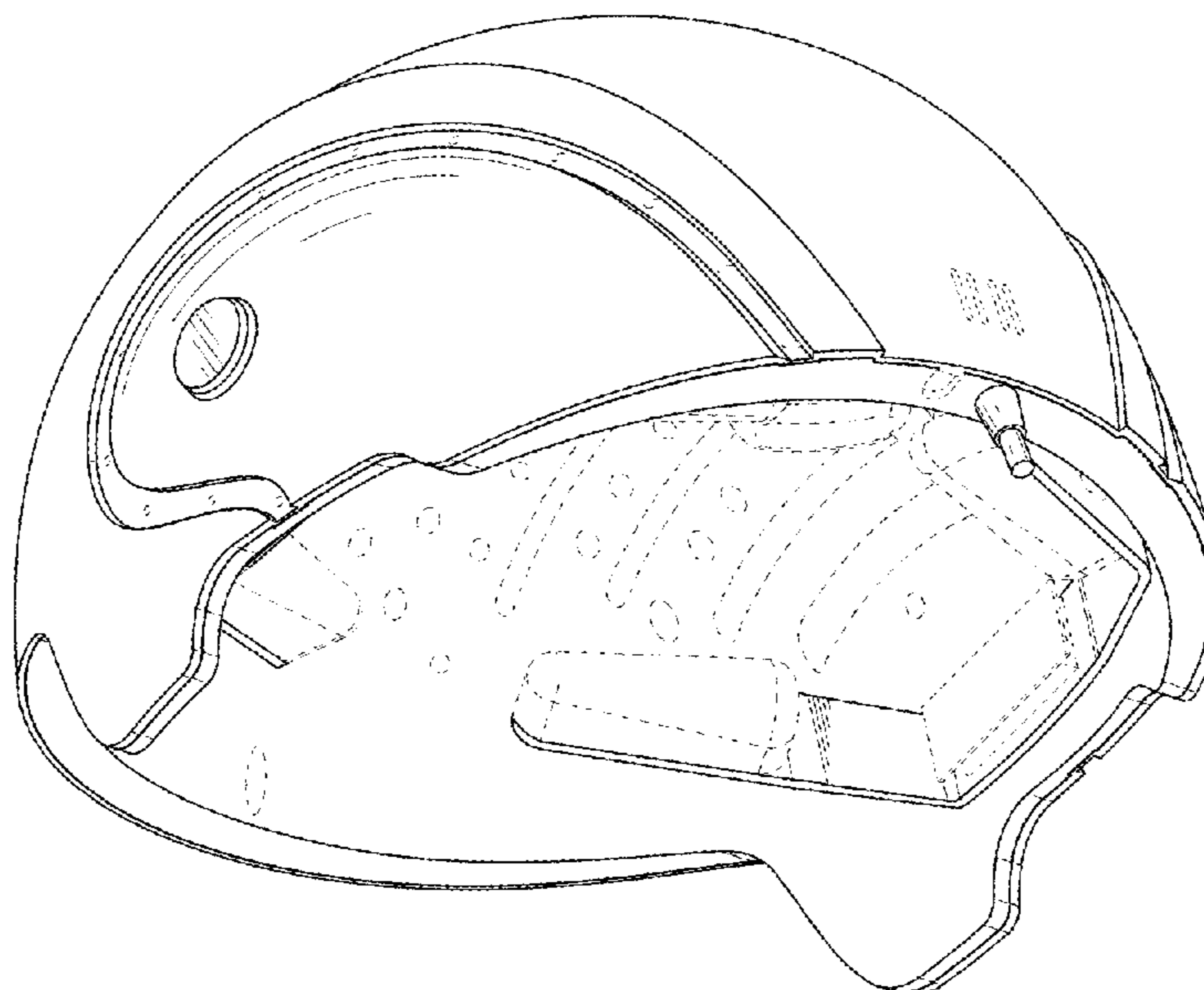

(56)

References Cited

OTHER PUBLICATIONS

5 Best Laser Helmets for Hair Growth, HairMighty.com, date published Nov. 16, 2021, date retrieved Aug. 19, 2022—29791205—<https://hairmighty.com/best-laser-helmets-for-hair-growth/> (Year: 2021).*

* cited by examiner

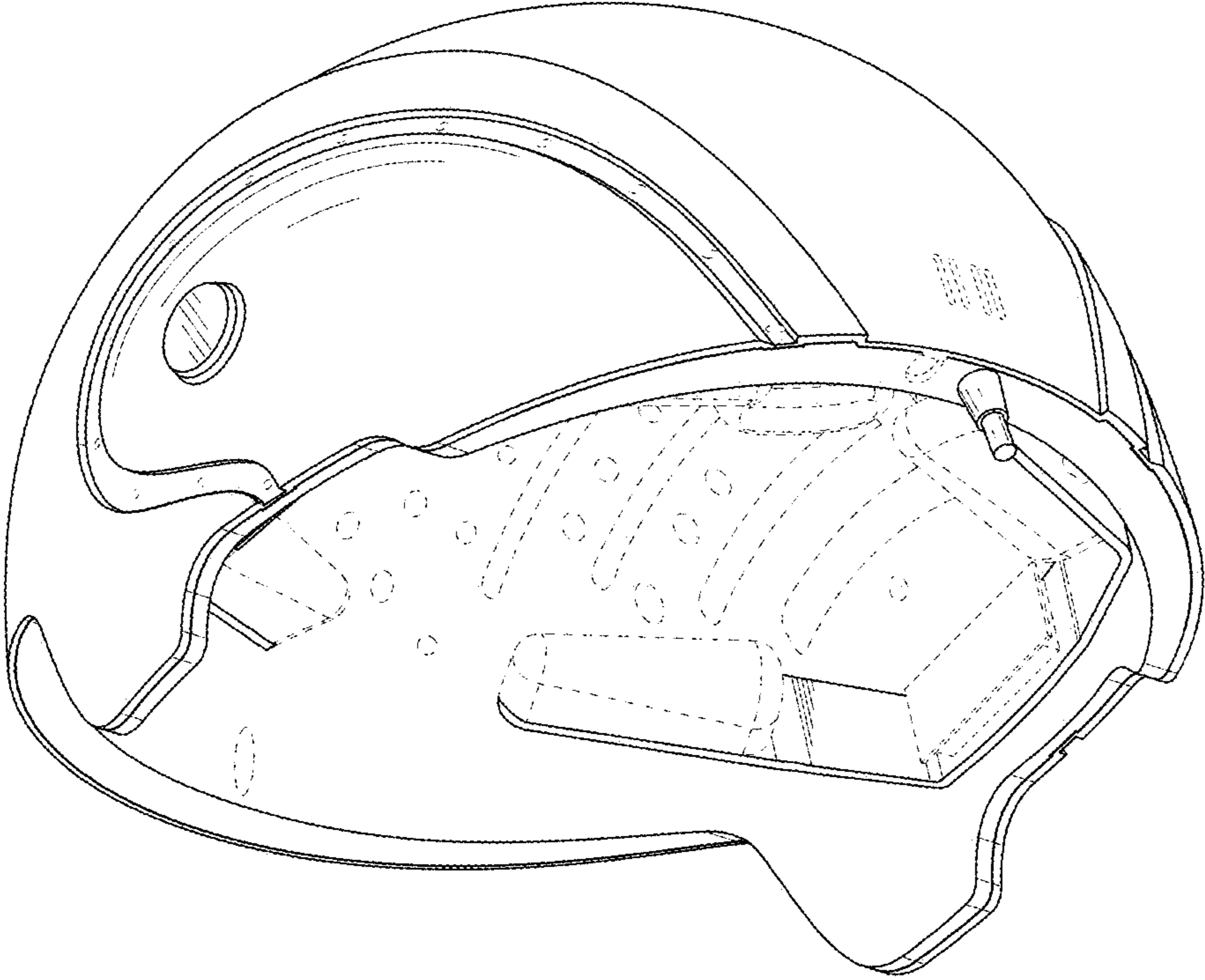

FIG. 1

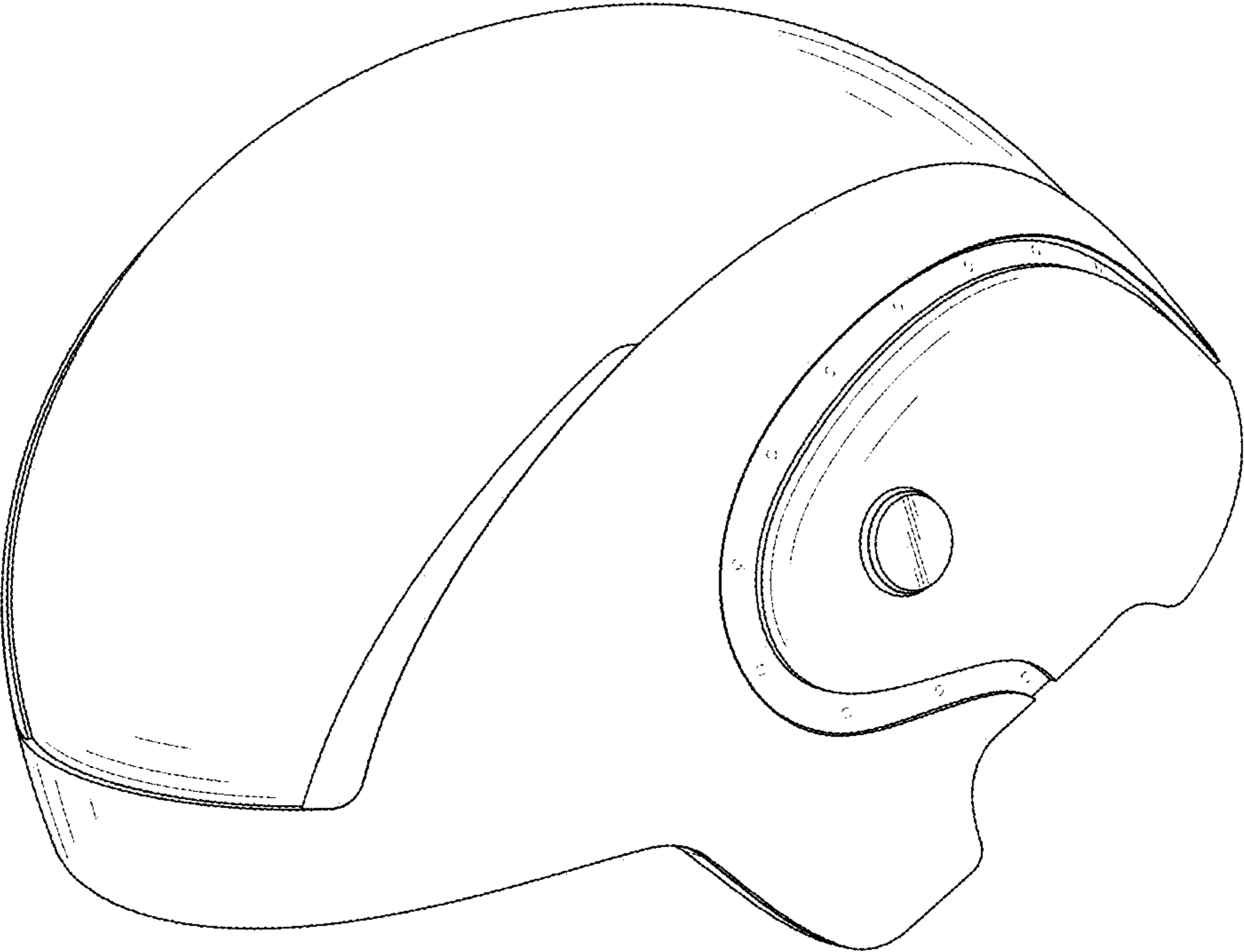

FIG. 2

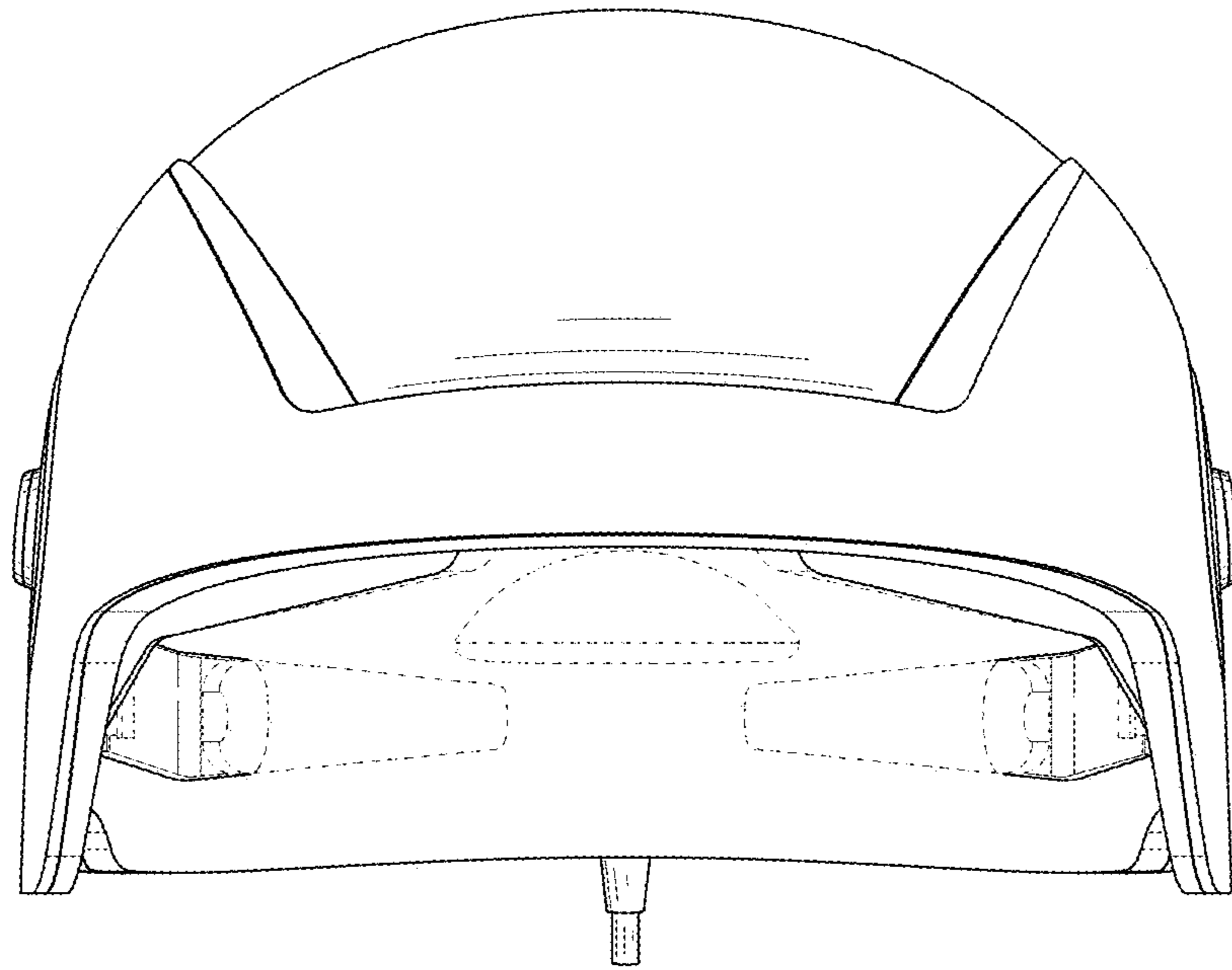

FIG. 3

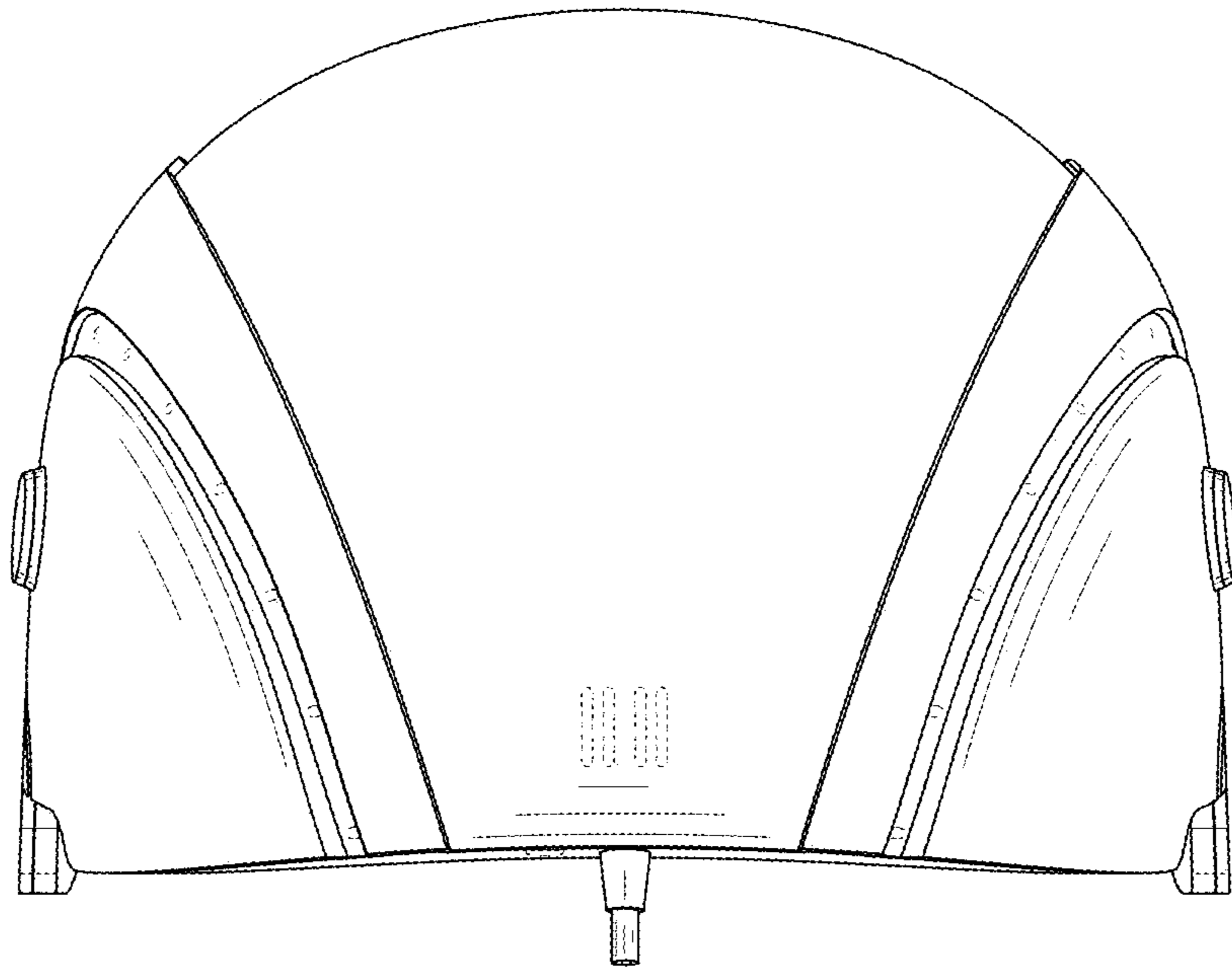

FIG. 4

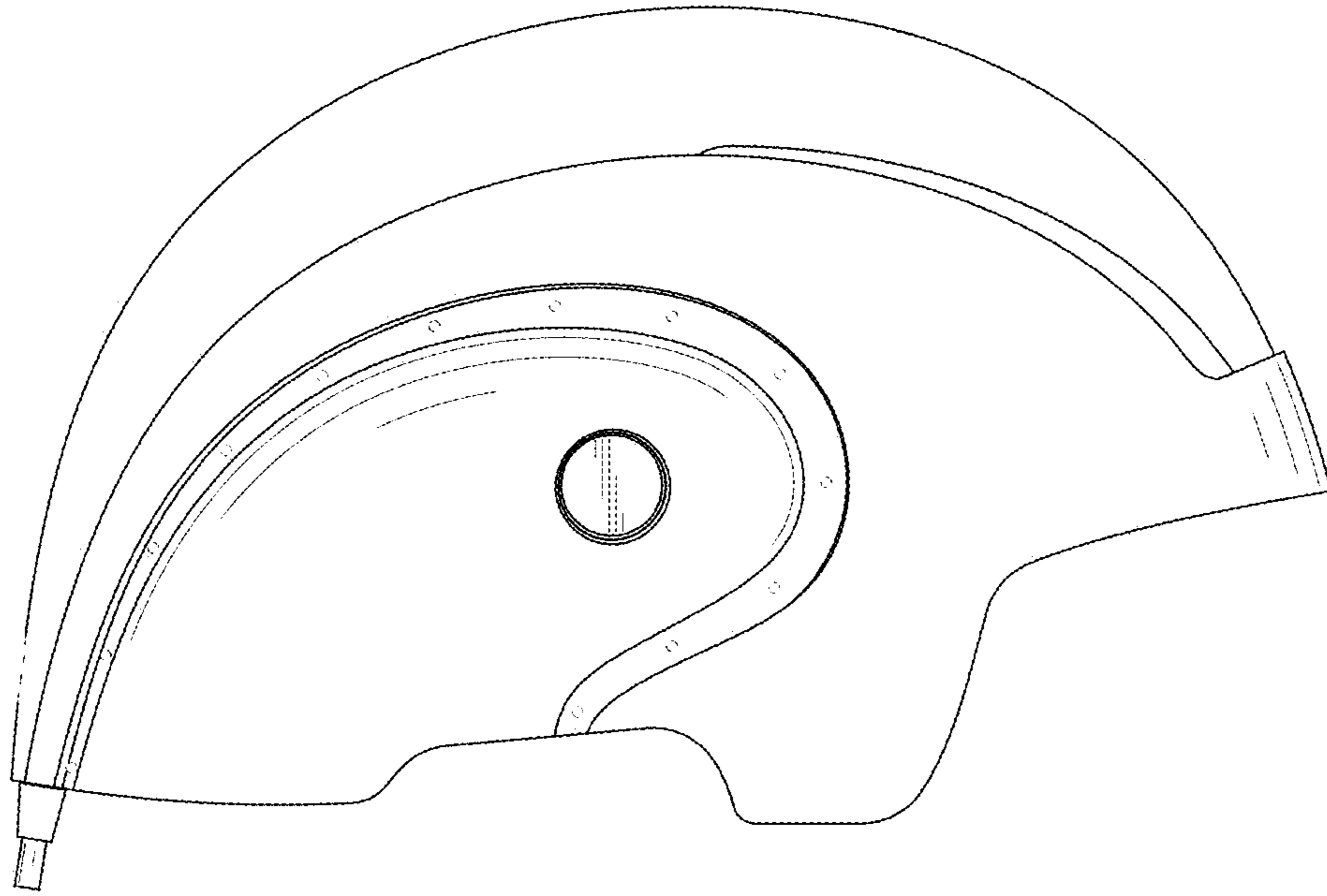

FIG. 5

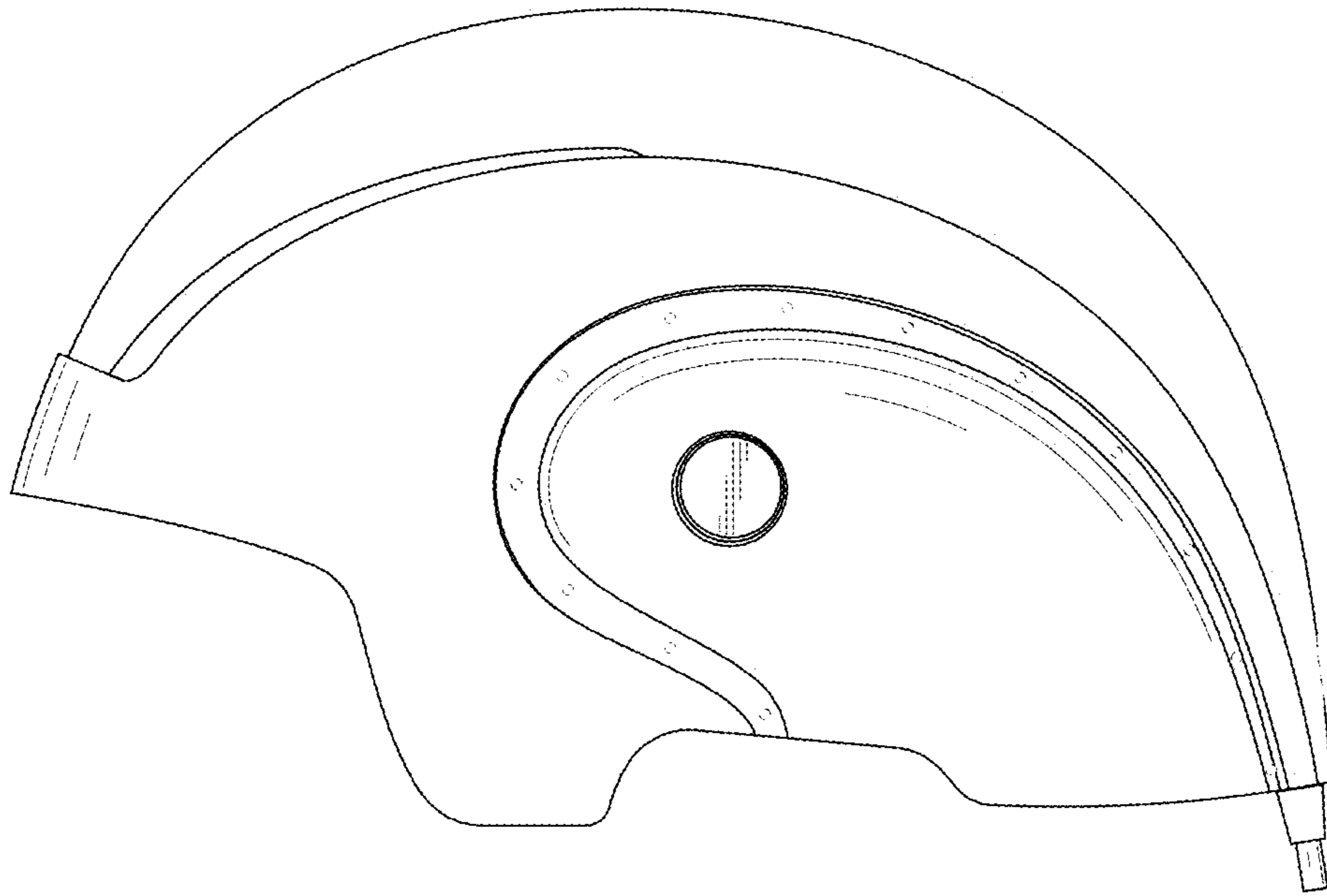

FIG. 6

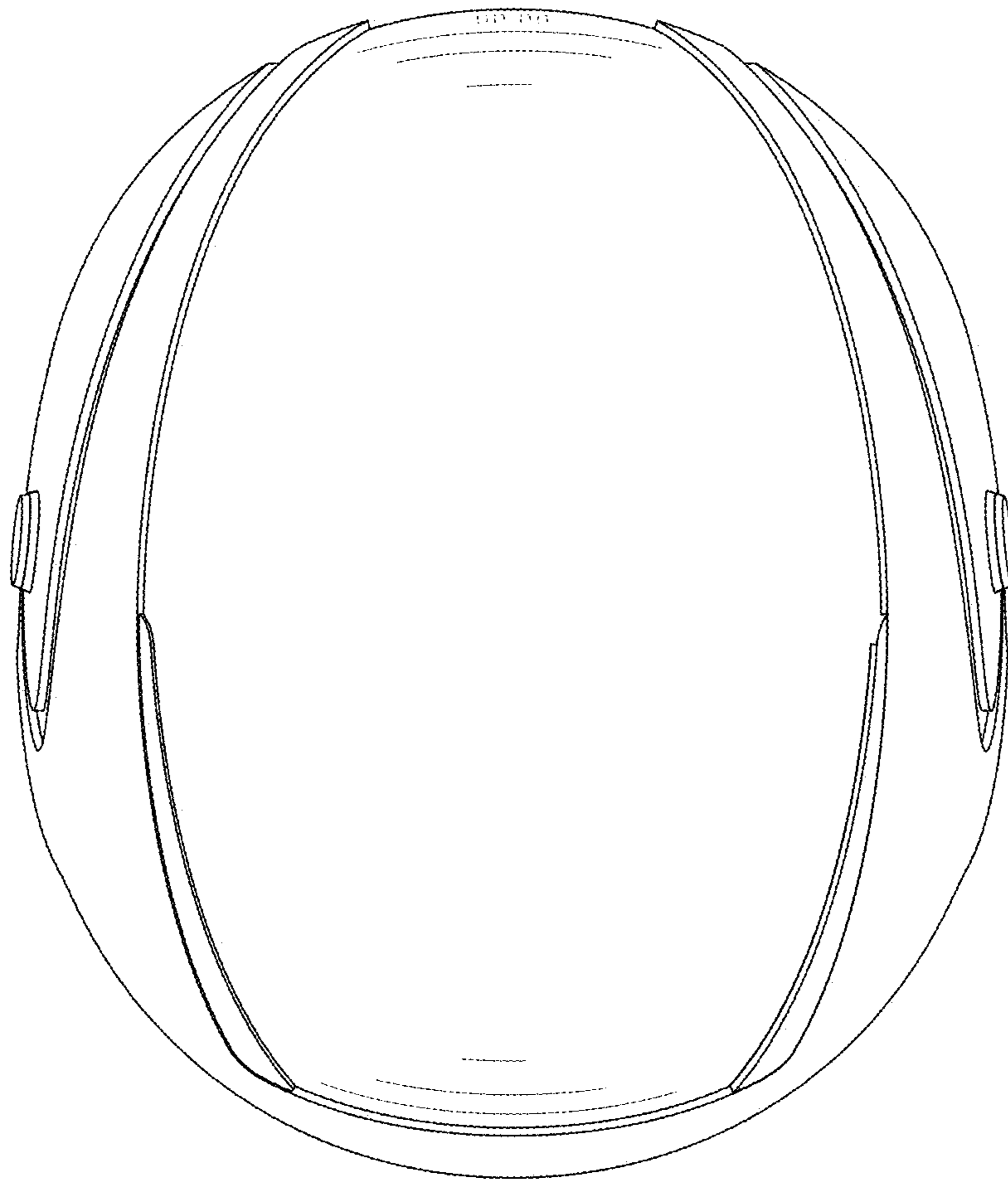

FIG. 7

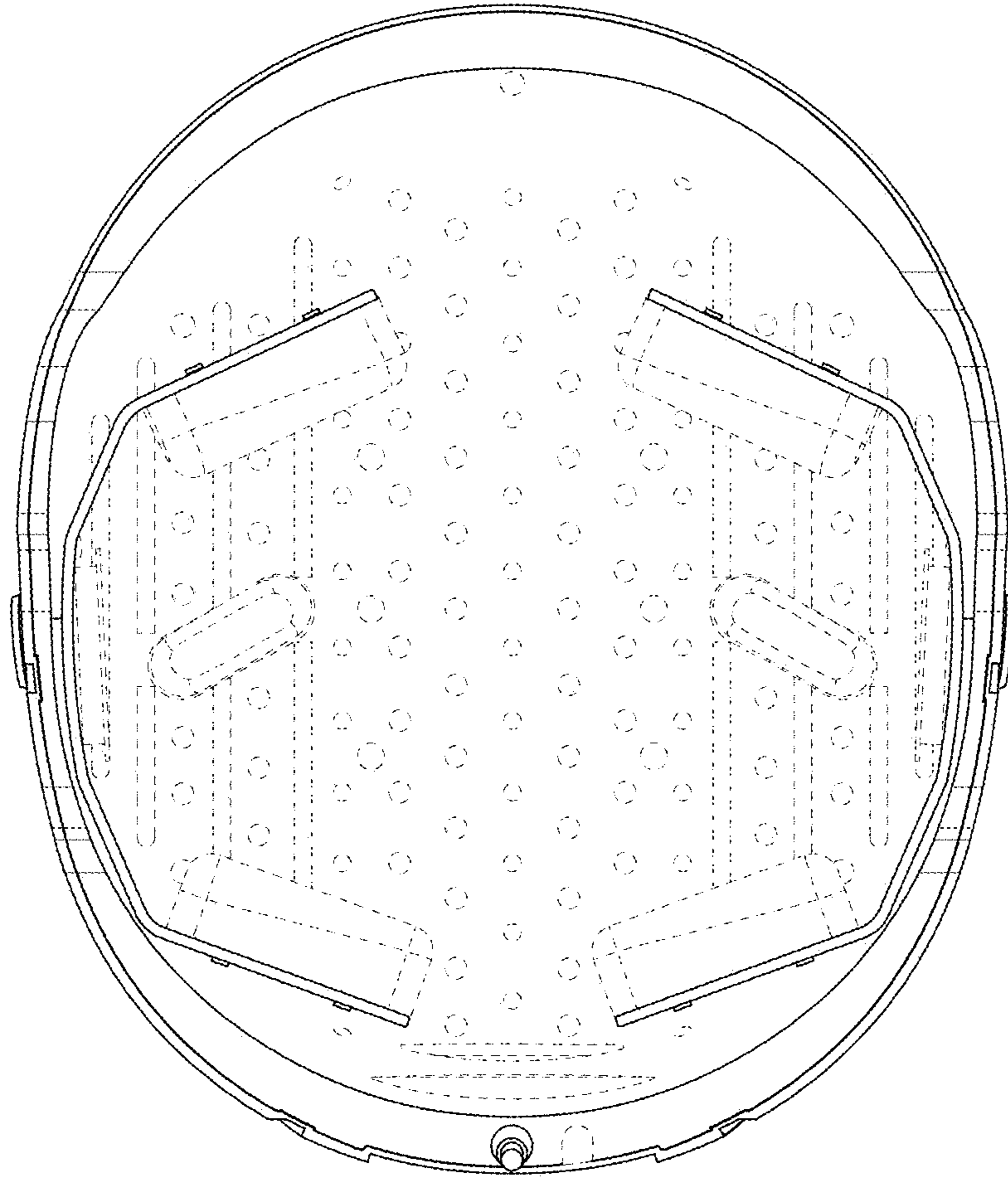

FIG. 8