



US00D988463S

(12) **United States Design Patent**  
**Maggiore**

(10) **Patent No.:** **US D988,463 S**

(45) **Date of Patent:** **\*\* Jun. 6, 2023**

- (54) **BUG KILLING PISTOL**
- (71) Applicant: **Loren Maggiore**, Santa Monica, CA (US)
- (72) Inventor: **Loren Maggiore**, Santa Monica, CA (US)
- (73) Assignee: **Skell Inc.**, Santa Monica, CA (US)
- (\*\*) Term: **15 Years**
- (21) Appl. No.: **29/810,627**
- (22) Filed: **Oct. 7, 2021**
- (51) **LOC (14) Cl.** ..... **22-06**
- (52) **U.S. Cl.**  
USPC ..... **D22/122; D22/104**
- (58) **Field of Classification Search**  
USPC ..... D22/104, 122; D21/573-575; 222/79; 124/36  
CPC ..... F41B 11/52; F41B 11/1162; F41B 11/68; F41B 11/80; F41C 3/00; A01M 3/00  
See application file for complete search history.

- D179,657 S \* 2/1957 Pittman, Jr. .... D22/104
- D251,914 S \* 5/1979 Romano ..... D22/104
- D297,334 S \* 8/1988 Trent ..... D19/65
- D297,554 S \* 9/1988 DeHart ..... D22/104
- 4,790,819 A \* 12/1988 Li ..... A61B 17/00491  
604/218
- D338,054 S \* 8/1993 Cummings ..... D22/104
- D693,811 S \* 11/2013 Augustin, Jr. .... D14/418
- 11,363,809 B2 \* 6/2022 Gangarosa ..... A01M 3/005
- 11,510,403 B1 \* 11/2022 Adams ..... F41B 7/003

\* cited by examiner

*Primary Examiner* — Catherine R Oliver-Garcia  
(74) *Attorney, Agent, or Firm* — Pryor Cashman LLP

- (56) **References Cited**  
U.S. PATENT DOCUMENTS  
1,611,533 A \* 12/1926 Kirsten ..... F41B 9/0037  
222/401  
D167,396 S \* 8/1952 Eigen ..... D21/575

(57) **CLAIM**

I claim the ornamental design for the bug killing pistol, as shown and described.

**DESCRIPTION**

FIG. 1 is a perspective view of my bug killing pistol; FIG. 2 is a right side elevational view thereof; FIG. 3 is a left side elevational view thereof; FIG. 4 is a front side elevational view thereof; FIG. 5 is a back side elevational view thereof; FIG. 6 is a top view thereof; and, FIG. 7 is a bottom view thereof.

**1 Claim, 5 Drawing Sheets**

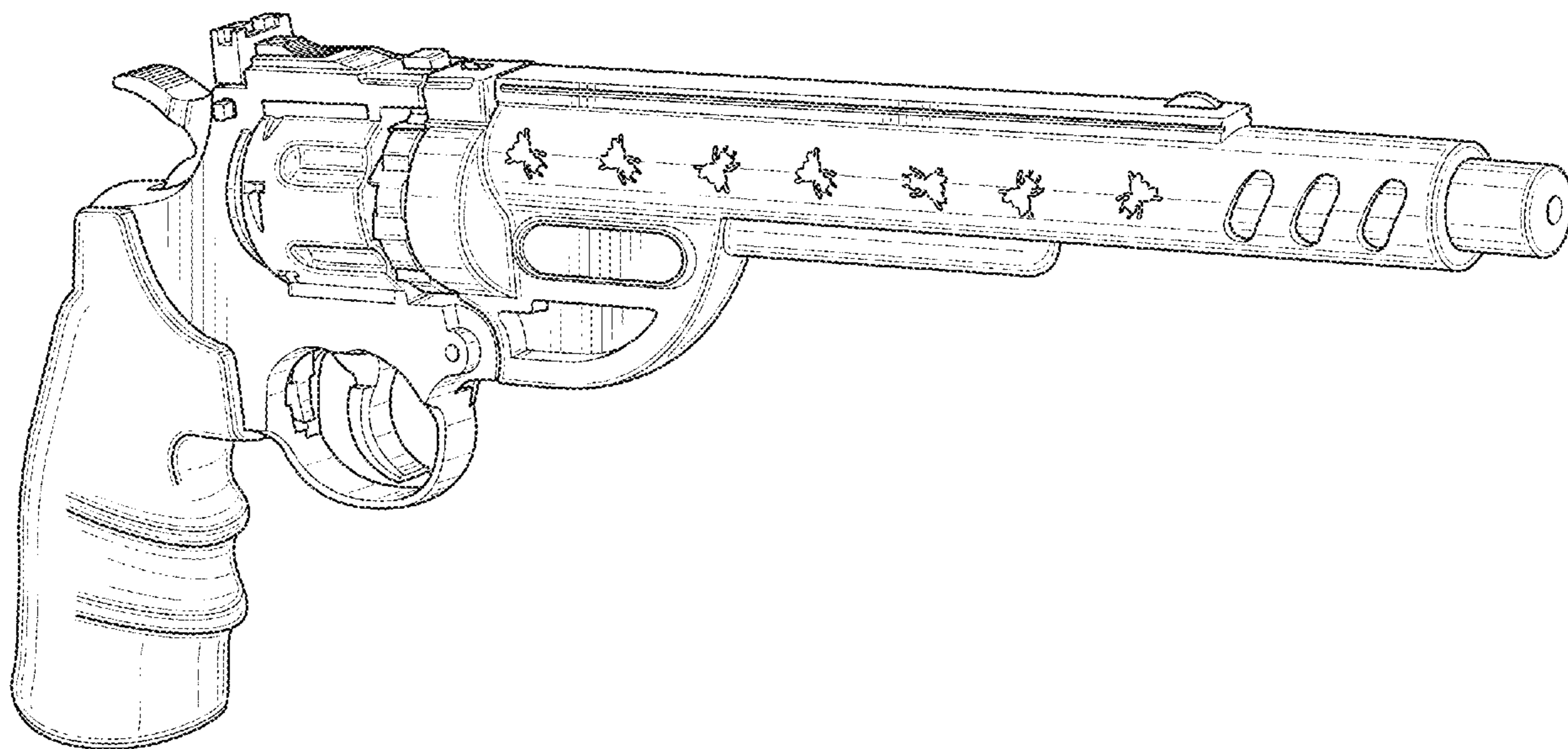

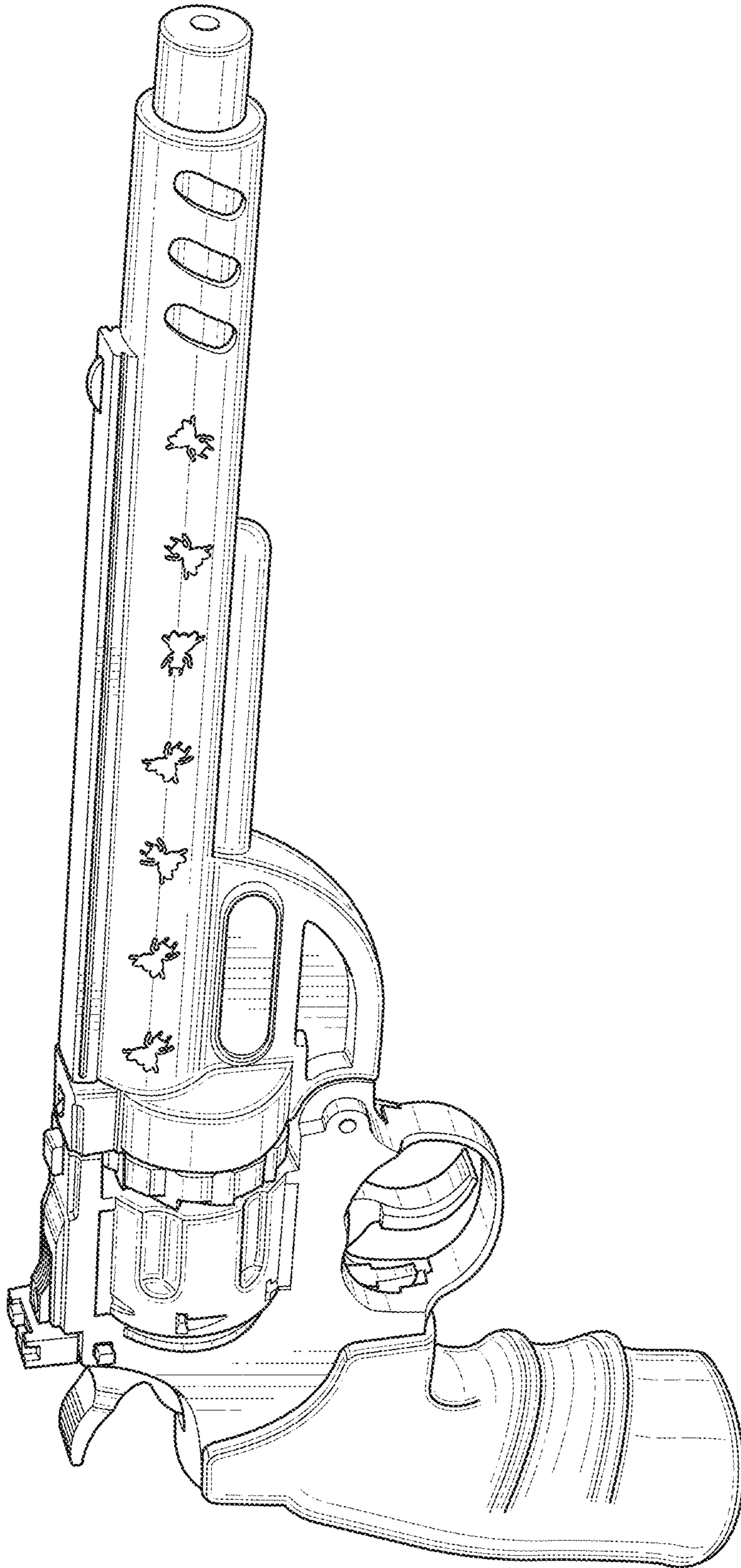

FIG. 1

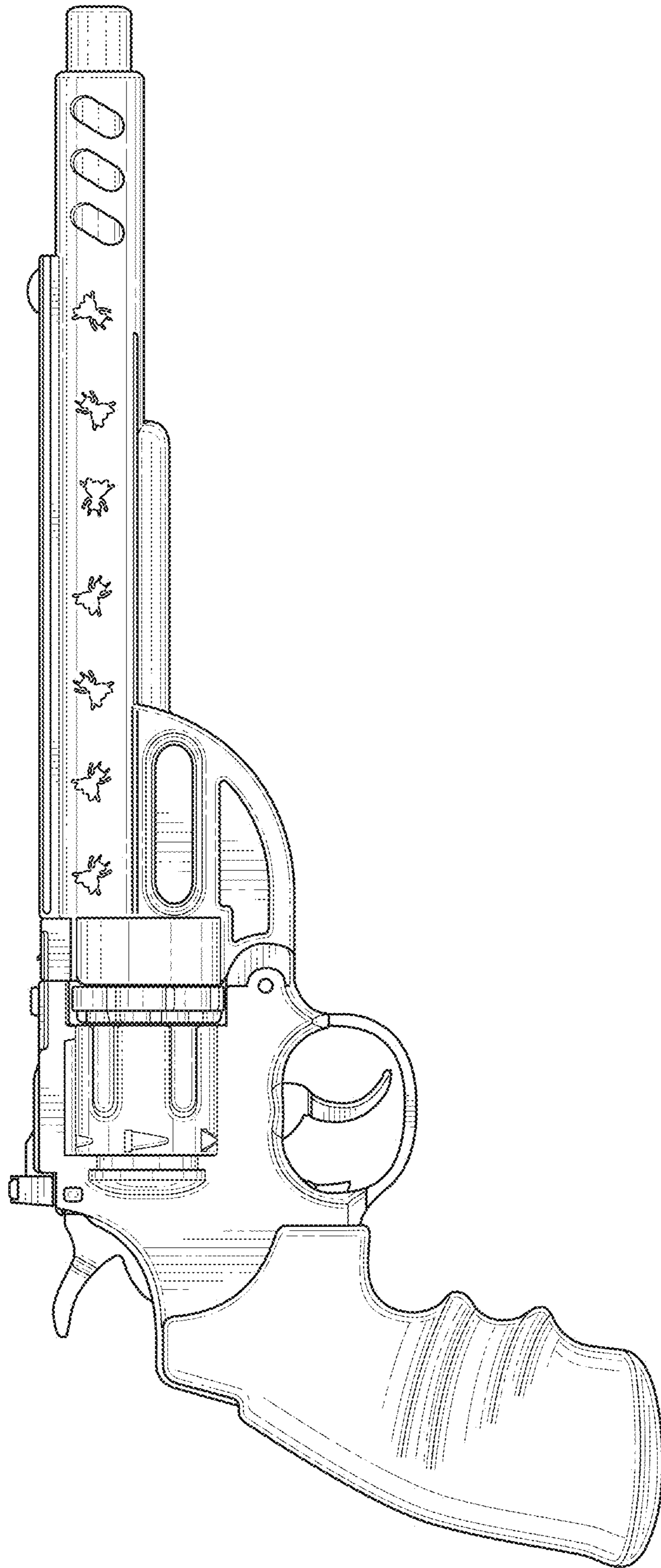

FIG. 2

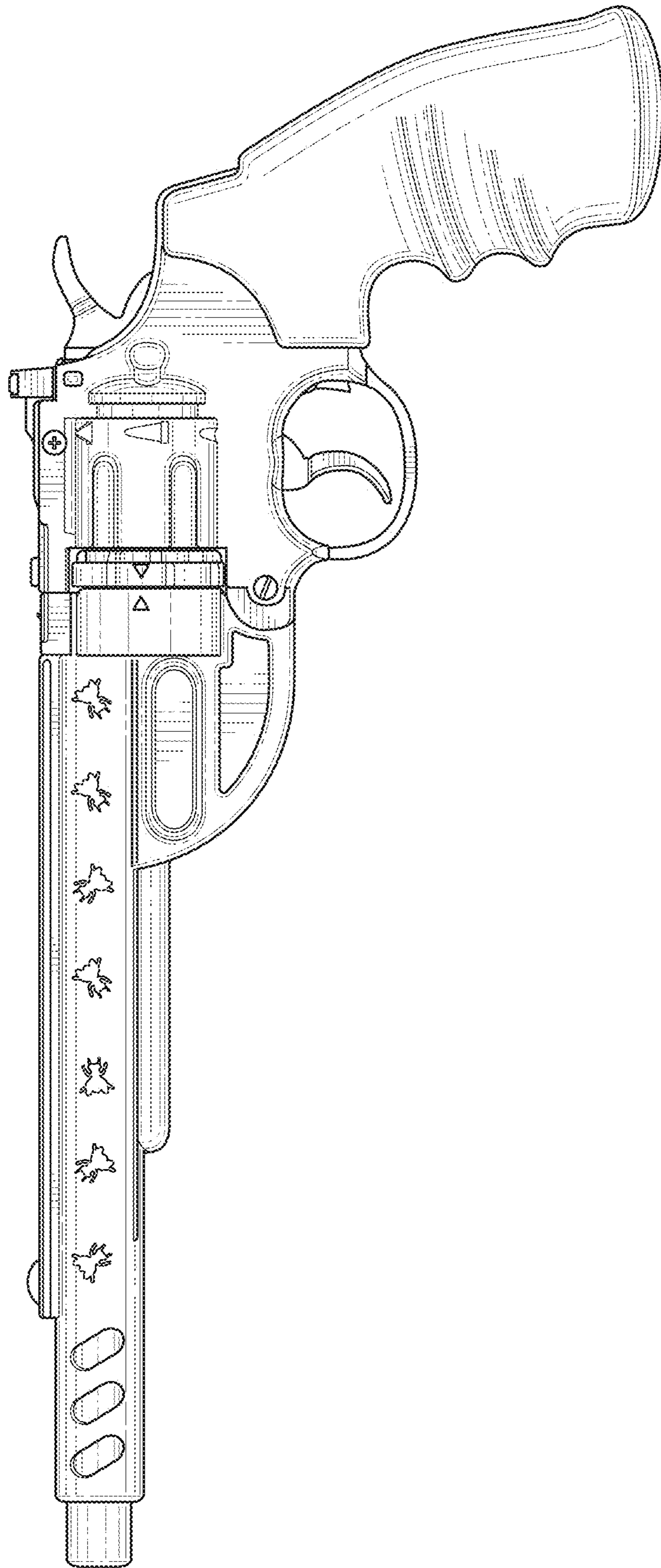

FIG. 3

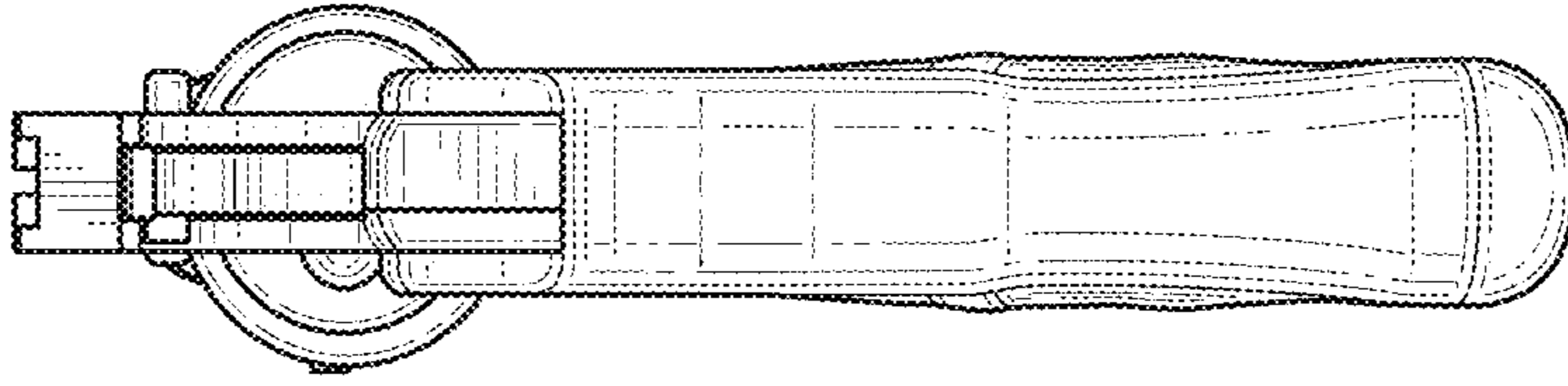

FIG. 5

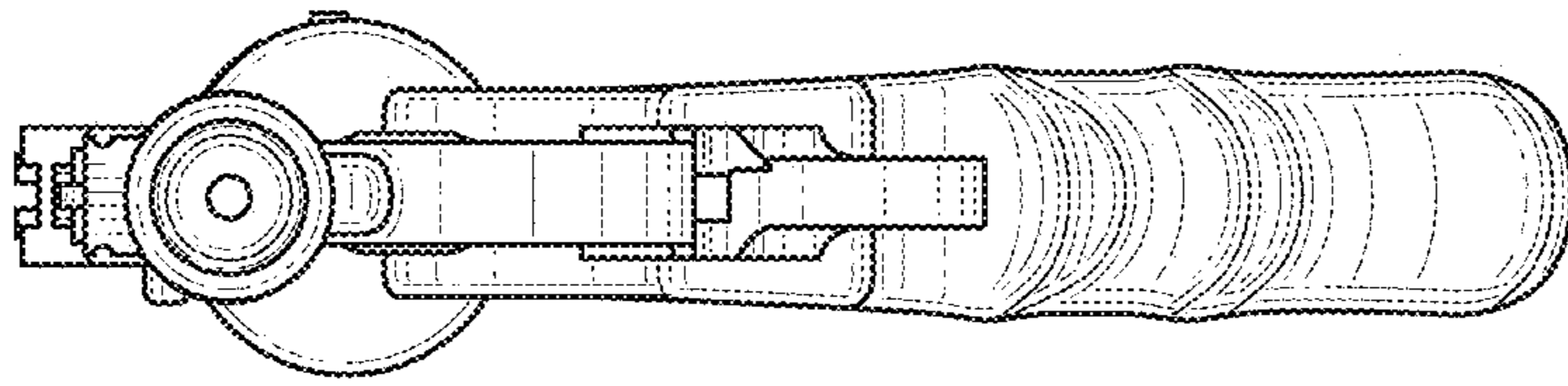

FIG. 4

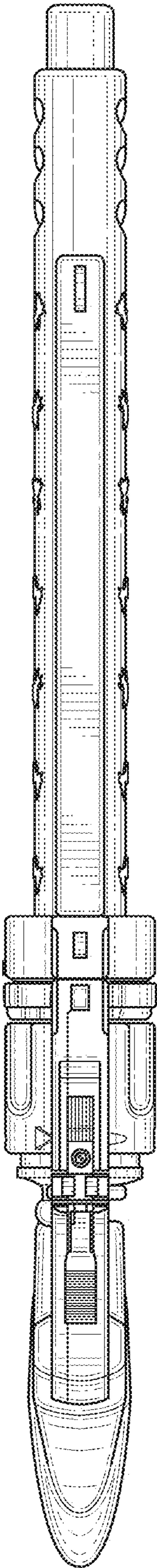

FIG. 6

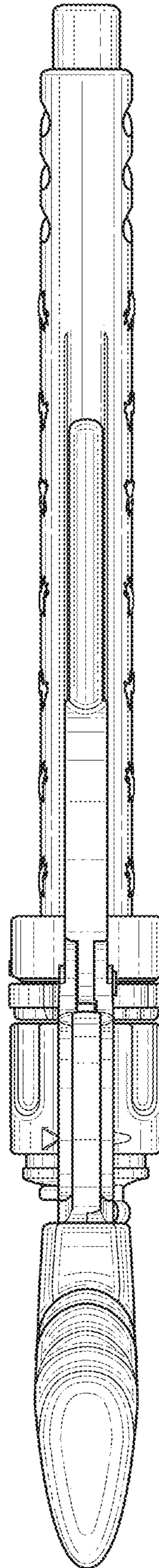

FIG. 7