



US00D988300S

(12) **United States Design Patent**
Horn

(10) **Patent No.:** **US D988,300 S**
(45) **Date of Patent:** **** Jun. 6, 2023**

(54) **IOT MODULE**

FOREIGN PATENT DOCUMENTS

(71) Applicant: **THALES DIS AIS Deutschland GmbH, Munich (DE)**

CN 304747253 * 7/2018
CN 306203895 * 12/2020
JP D1713286 * 4/2022

(72) Inventor: **Annette Horn, Munich (DE)**

OTHER PUBLICATIONS

(**) Term: **15 Years**

Quectel, "EC25 Series" available at mouser.com, date published 2020, site visited Oct. 18, 2022, available at URL: <https://www.mouser.com/ProductDetail/Quectel/EC25AFFD-512-SGAS?qs=zW32dvEIR3tHTCprkoFwVw%3D%3D&mgh=1> (Year: 2020).*

(21) Appl. No.: **35/513,793**

(Continued)

(22) Filed: **Sep. 6, 2021**

(80) **Hague Agreement Data**

Primary Examiner — Daniel J Domino
Assistant Examiner — Samina Vieth

Int. Filing Date: **Sep. 6, 2021**

Int. Reg. No.: **DM/216316**

Int. Reg. Date: **Sep. 6, 2021**

Int. Reg. Pub. Date: **Mar. 11, 2022**

(57) **CLAIM**

The ornamental design for IoT module, as shown and described.

(30) **Foreign Application Priority Data**

DESCRIPTION

Mar. 9, 2021 (EM) 008455174-0001
Mar. 9, 2021 (EM) 008455174-0002

(Continued)

(51) **LOC (14) Cl.** **14-03**

(52) **U.S. Cl.**
USPC **D14/230**

(58) **Field of Classification Search**
USPC D14/230, 231-239, 356-359, 435-437,
D14/155; D10/104.1, 106.9; D13/147,
D13/182

(Continued)

(56) **References Cited**

U.S. PATENT DOCUMENTS

D318,461 S * 7/1991 Hasegawa D13/182
D319,814 S * 9/1991 Hasegawa D13/182

(Continued)

- 1. IoT module
- 2. IoT module
- 3. IoT module
- 4. IoT module
- 5. IoT module
- 6. IoT module
- 1.1 : Bottom
- 1.2 : Top
- 1.3 : Right
- 1.4 : Left
- 1.5 : Front
- 1.6 : Back
- 1.7 : Perspective
- 2.1 : Bottom
- 2.2 : Top
- 2.3 : Right
- 2.4 : Left
- 2.5 : Front
- 2.6 : Back
- 2.7 : Perspective

(Continued)

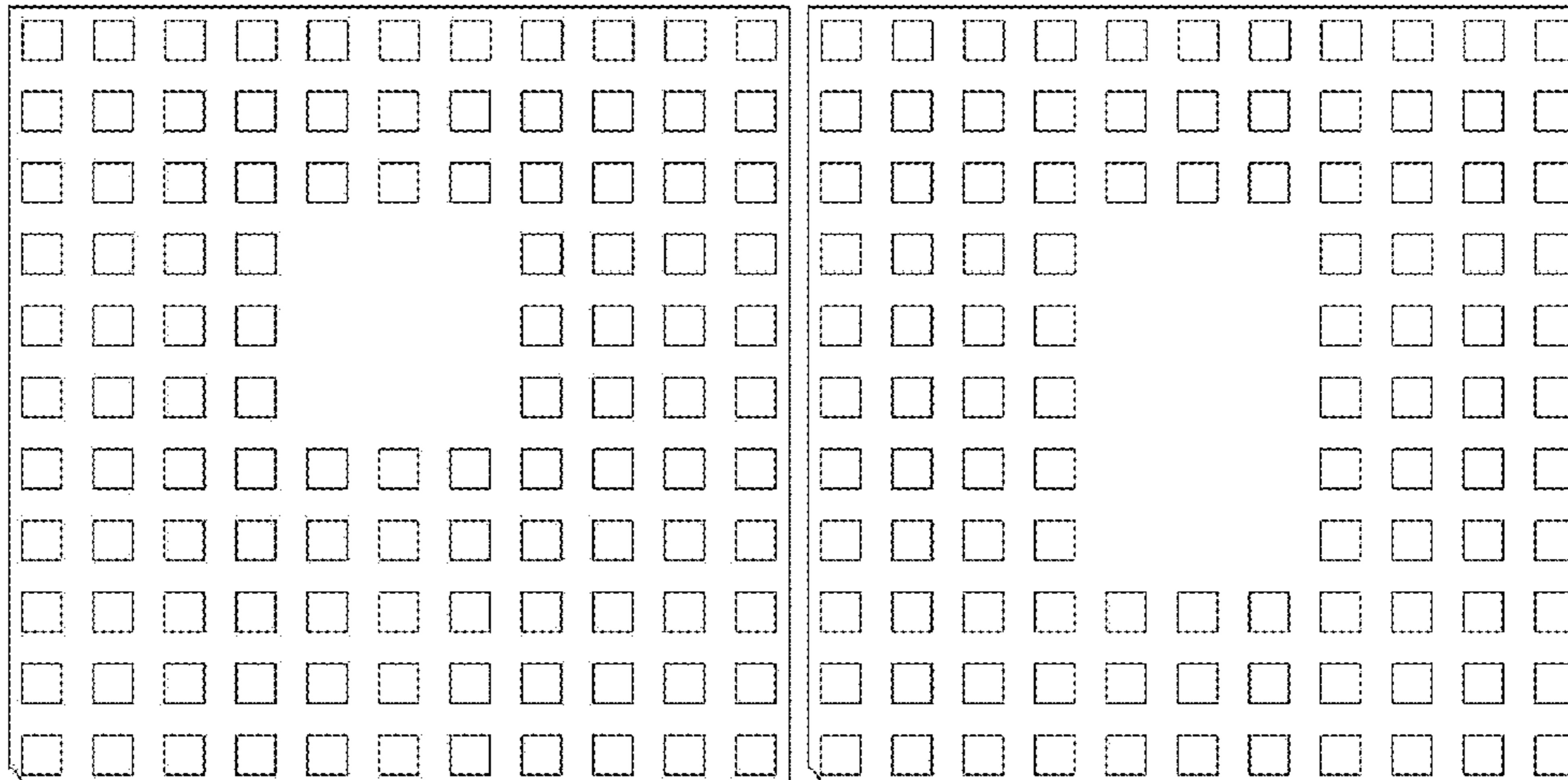

- 3.1 : Bottom
- 3.2 : Top
- 3.3 : Right
- 3.4 : Left
- 3.5 : Front
- 3.6 : Back
- 3.7 : Perspective
- 4.1 : Bottom
- 4.2 : Top
- 4.3 : Right
- 4.4 : Left
- 4.5 : Front
- 4.6 : Back
- 4.7 : Perspective
- 5.1 : Bottom
- 5.2 : Top
- 5.3 : Right
- 5.4 : Left
- 5.5 : Front
- 5.6 : Back
- 5.7 : Perspective
- 6.1 : Bottom
- 6.2 : Top
- 6.3 : Right
- 6.4 : Left
- 6.5 : Front
- 6.6 : Back
- 6.7 : Perspective

Designs No. 1 and 2 show square versions of an IoT module respectively with or without pads arrangements in the lower part of the module center; designs No. 3 and 4 show rectangular versions of an IoT module respectively with or without pads arrangements in the lower part of the module center; designs No. 5 and No. 6 show scaled versions of an IoT module respectively with or without pads arrangements in the lower part of the module center. The dashed broken lines illustrate portions of the article, and form no part of the claimed design.

1 Claim, 42 Drawing Sheets

(30) **Foreign Application Priority Data**

- Mar. 9, 2021 (EM) 008455174-0003
- Mar. 9, 2021 (EM) 008455174-0005
- Mar. 9, 2021 (EM) 008455174-0006

(58) **Field of Classification Search**

CPC H01Q 1/241; H01Q 1/243; H04B 1/38
See application file for complete search history.

(56) **References Cited**

U.S. PATENT DOCUMENTS

- D391,248 S * 2/1998 Wanishi D14/489
- D393,253 S * 4/1998 Morioka D14/489

- D540,272 S * 4/2007 Higashibata D13/182
- D548,705 S * 8/2007 Hayashi D13/182
- D552,565 S * 10/2007 Nakamura D13/182
- D687,524 S * 8/2013 Heiser D23/261
- D697,038 S * 1/2014 Matsumoto D13/182
- D699,201 S * 2/2014 Petsch D13/182
- D704,155 S * 5/2014 Chang D13/182
- D715,410 S * 10/2014 Lohmann D23/259
- D720,837 S * 1/2015 Bernoti D23/260
- D721,795 S * 1/2015 Bernoti D23/260
- D737,779 S * 9/2015 Druscovich D13/147
- D746,955 S * 1/2016 Corder D23/261
- D784,342 S * 4/2017 Kim D14/433
- D790,489 S * 6/2017 Toyomura D13/182
- D821,331 S * 6/2018 Druscovich D13/147
- D829,869 S * 10/2018 McClam D23/260
- D831,009 S * 10/2018 Horn D14/230
- 10,461,428 B2 * 10/2019 Jeong H01Q 9/0414
- D867,316 S * 11/2019 Newton D14/137
- D872,032 S * 1/2020 Morelli D13/147
- D872,033 S * 1/2020 Morelli D13/147
- D904,355 S * 12/2020 Horn D14/230
- 10,912,682 B2 * 2/2021 Takahashi A61F 13/51108
- D912,219 S * 3/2021 McDanal D23/397
- D915,565 S * 4/2021 Meyers D23/261
- D929,383 S * 8/2021 Hwang D14/250
- D937,232 S * 11/2021 Okawa D13/182
- 11,192,325 B2 * 12/2021 Warashina B32B 29/005
- D942,974 S * 2/2022 Horn D14/230
- 11,310,358 B2 * 4/2022 Choi G06F 3/0202
- 11,337,566 B2 * 5/2022 Yoshida B31F 1/12
- 11,389,344 B2 * 7/2022 Suyama A61F 13/515
- 2022/0013915 A1 * 1/2022 Han H01Q 9/0414

OTHER PUBLICATIONS

Telit, "LE910Cx" available at verical.com, date published 2020, site visited Oct. 18, 2022, available at URL: <https://www.verical.com/pd/telit-cellular-module-le910c1a565t0p1000-6861311> (Year: 2020).*

GPSworld.com, "Telit's latest GNSS IoT Module . . .", available at gpsworld.com, date published Nov. 5, 2018, site visited Oct. 18, 2022, available at URL: <https://www.gpsworld.com/telits-latest-gnss-iot-module-aimed-at-european-market/> (Year: 2018).*

Mediatek Inc, "MT6582" available at datasheetcafe.com, date posted Feb. 5, 2020, site visited Oct. 18, 2022, available at URL: <http://www.datasheetcafe.com/mt6582-datasheet-pdf/> (Year: 202).*

5gtechnologyworld.com, "Cellular LTE Cat 1 Modules Support 4G and 5g" available at 5gtechnologyworld.com, date published Dec. 16, 2021, site visited Oct. 18, 2022, available at URL: <https://www.5gtechnologyworld.com/cellular-lte-cat-1-modules-support-4g-and-5g/> (Year: 2021).*

Telit, "CE910-Dual available at arrow.com," date published 2015, site visited Oct. 18, 2022, available at URL: <https://www.arrow.com/en/datasheets/8986151318/telit/ce910-dual> (Year: 2015).*

Quectel, "BC66-NA" available at arrow.com, date published 2019, site visited Oct. 18, 2022, available at URL: <https://www.arrow.com/en/products/bc66-na/quectel-wireless-solutions-co-ltd> (Year: 2019).*

Telit, "ME910C1 Series" available at arrow.com, date published 2018, site visited Oct. 18, 2022, available at URL: <https://www.arrow.com/en/products/me910c1ww05t080100/telit> (Year: 2022).*

* cited by examiner

1.1

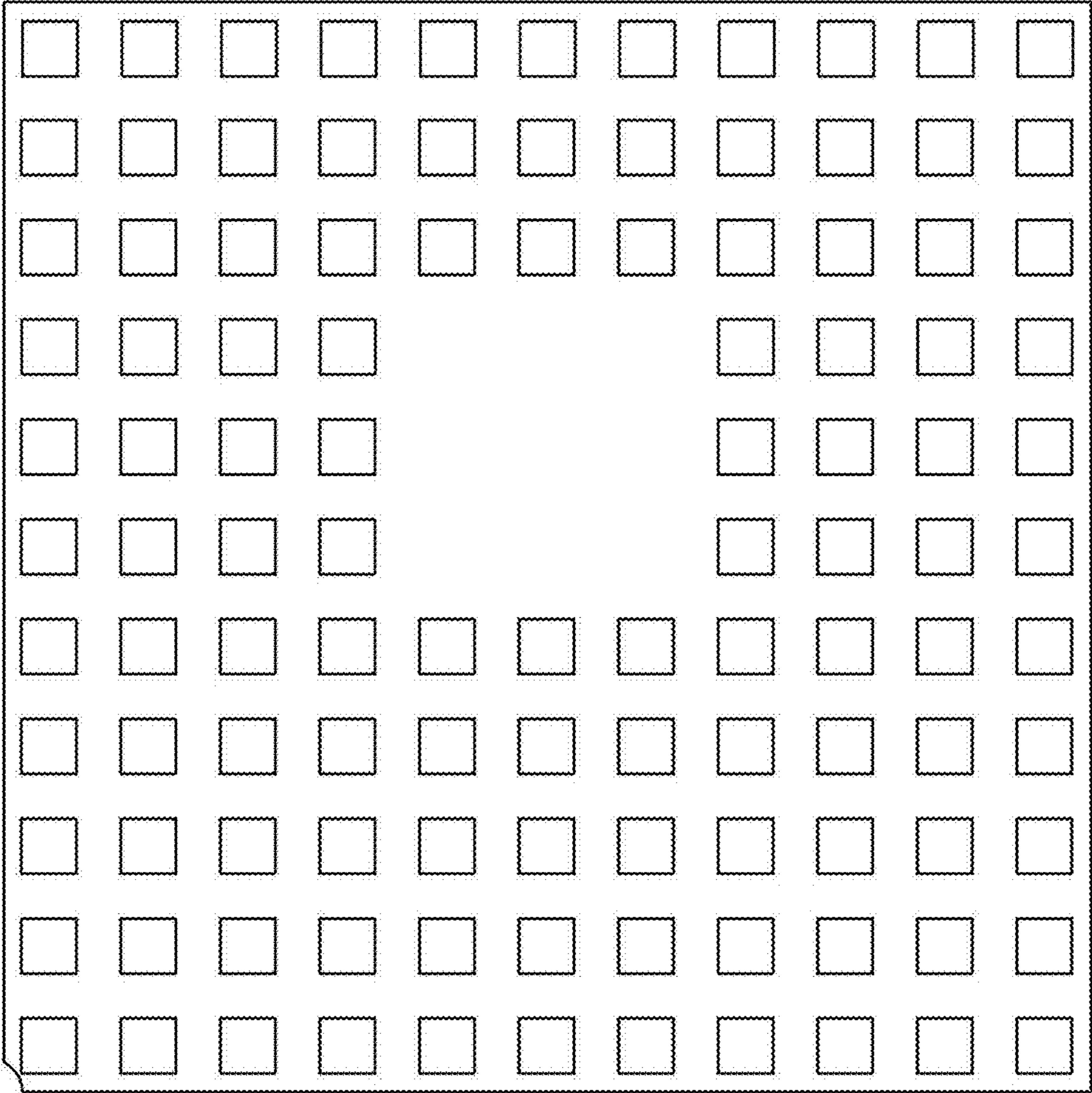

1.2

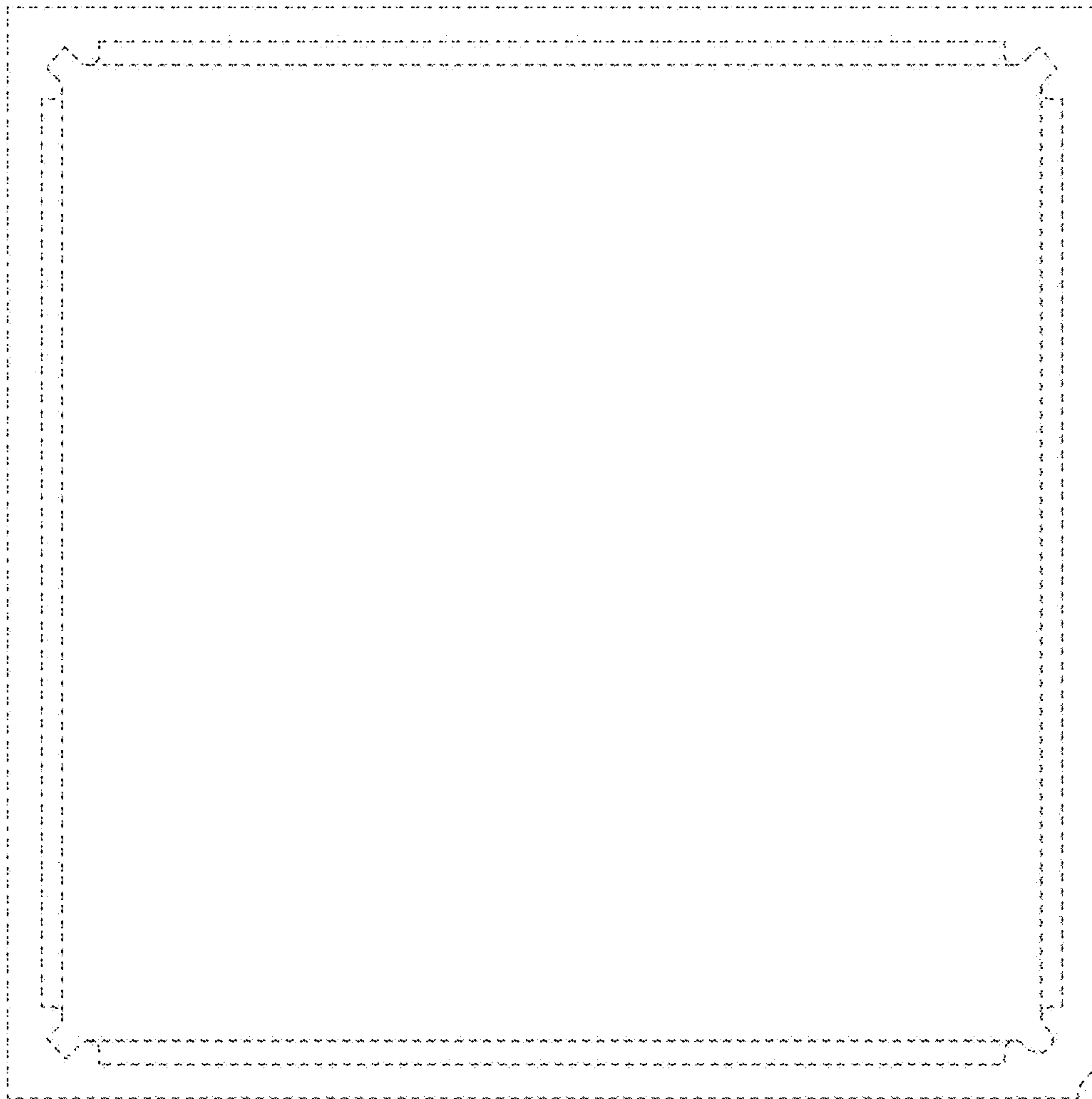

1.3

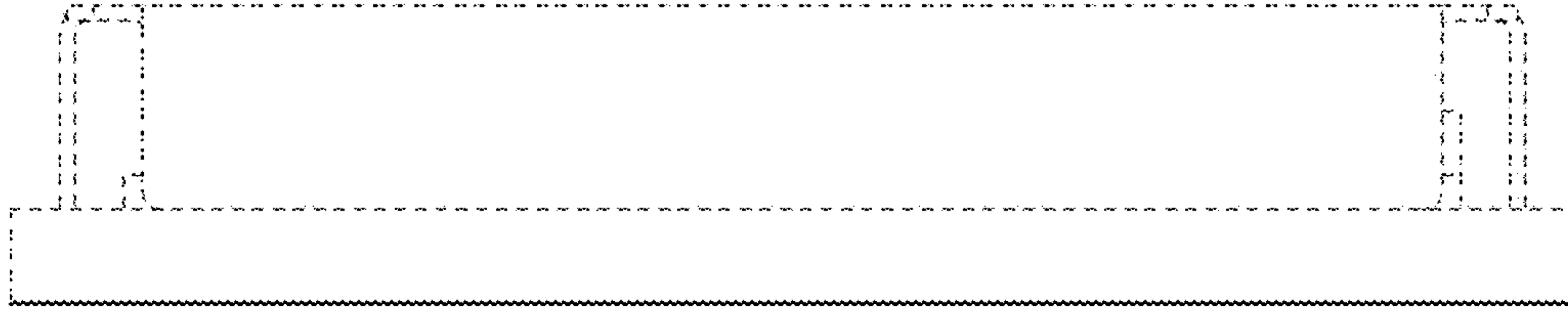

1.4

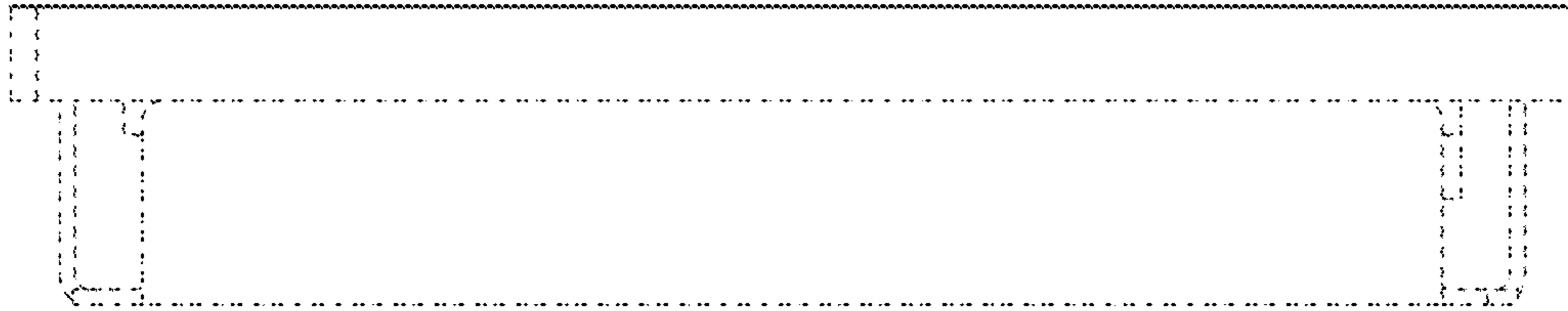

1.5

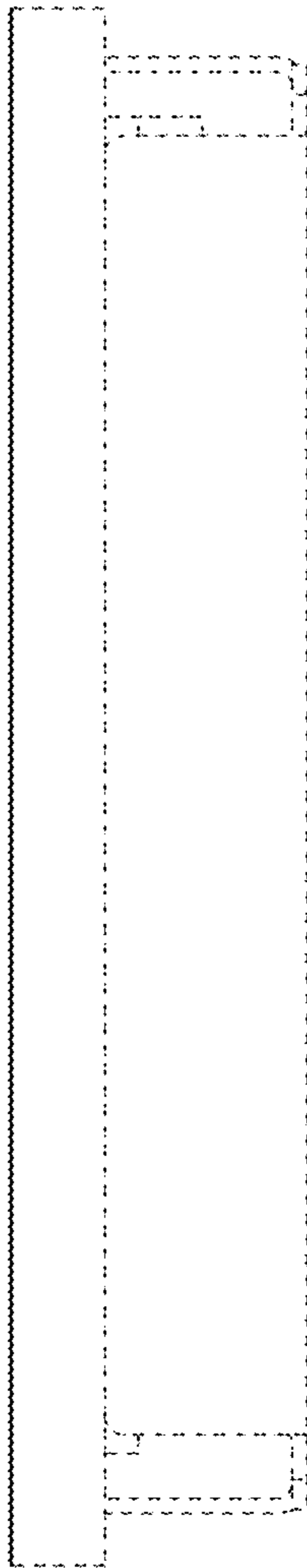

1.6

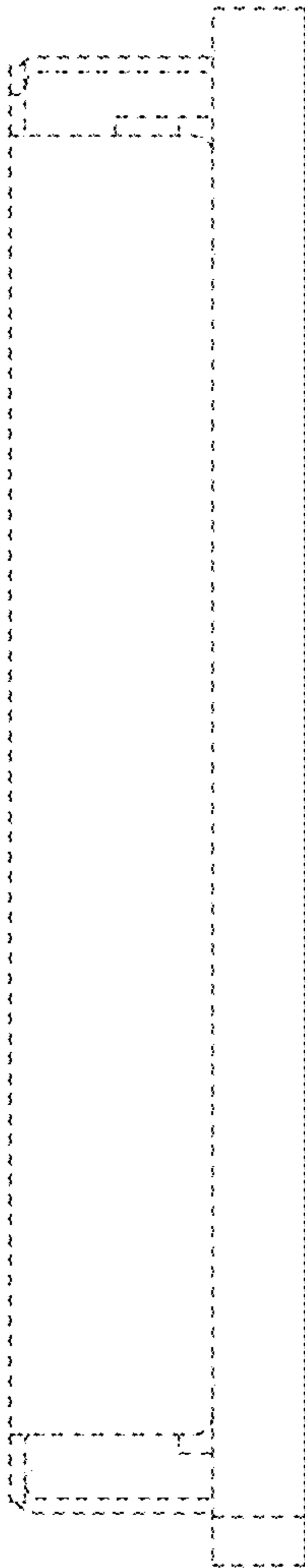

1.7

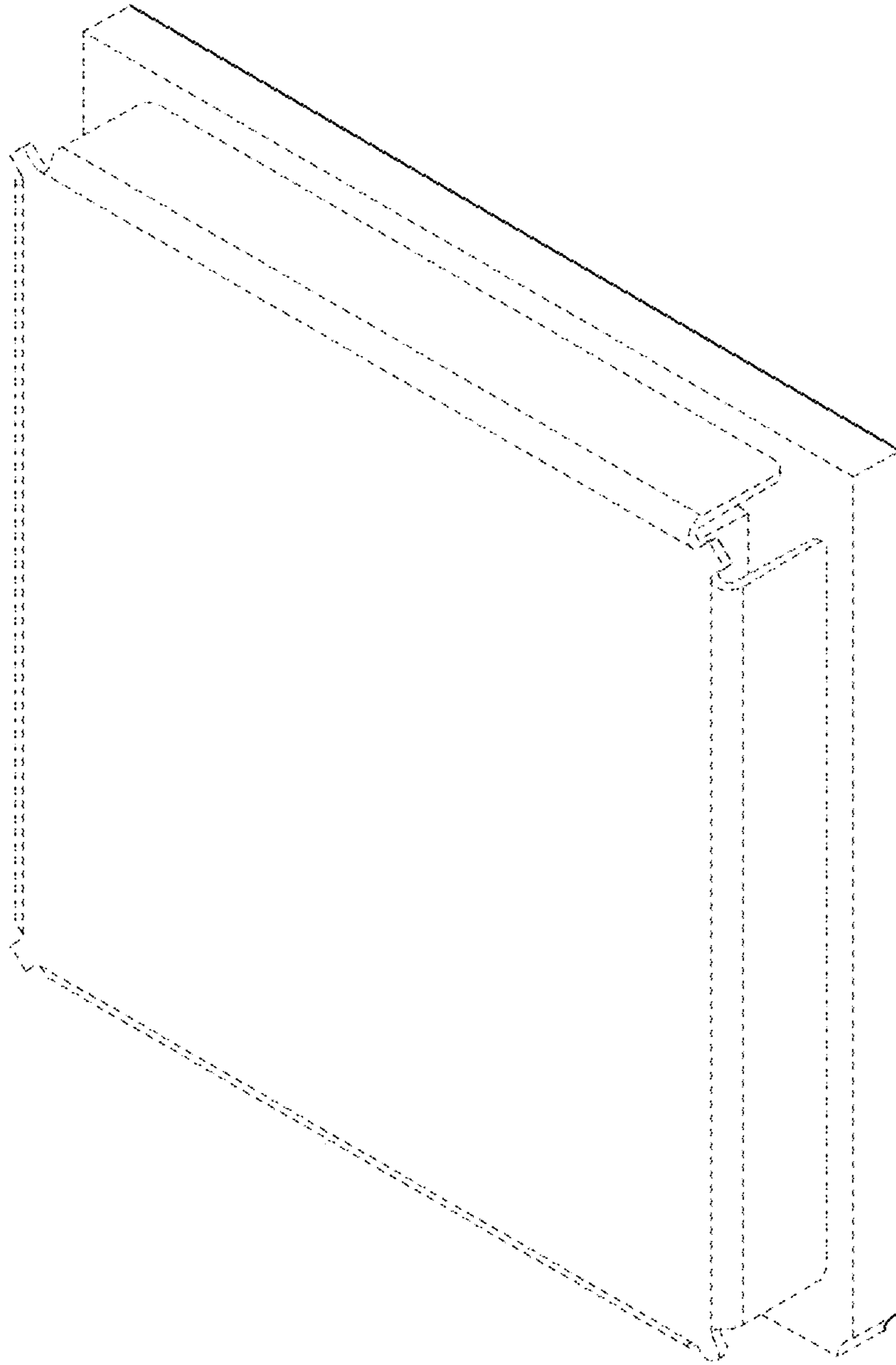

2.1

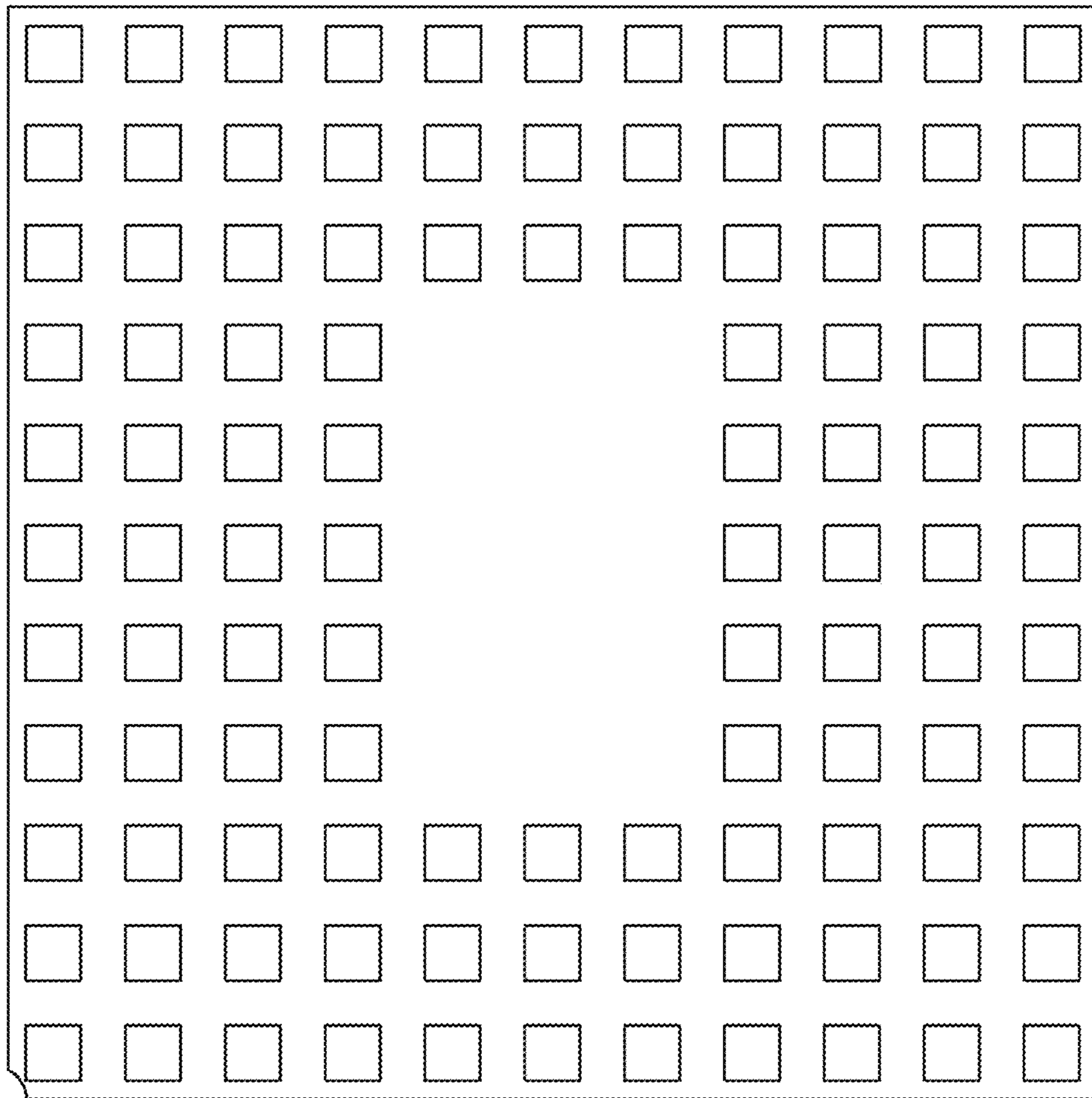

2.2

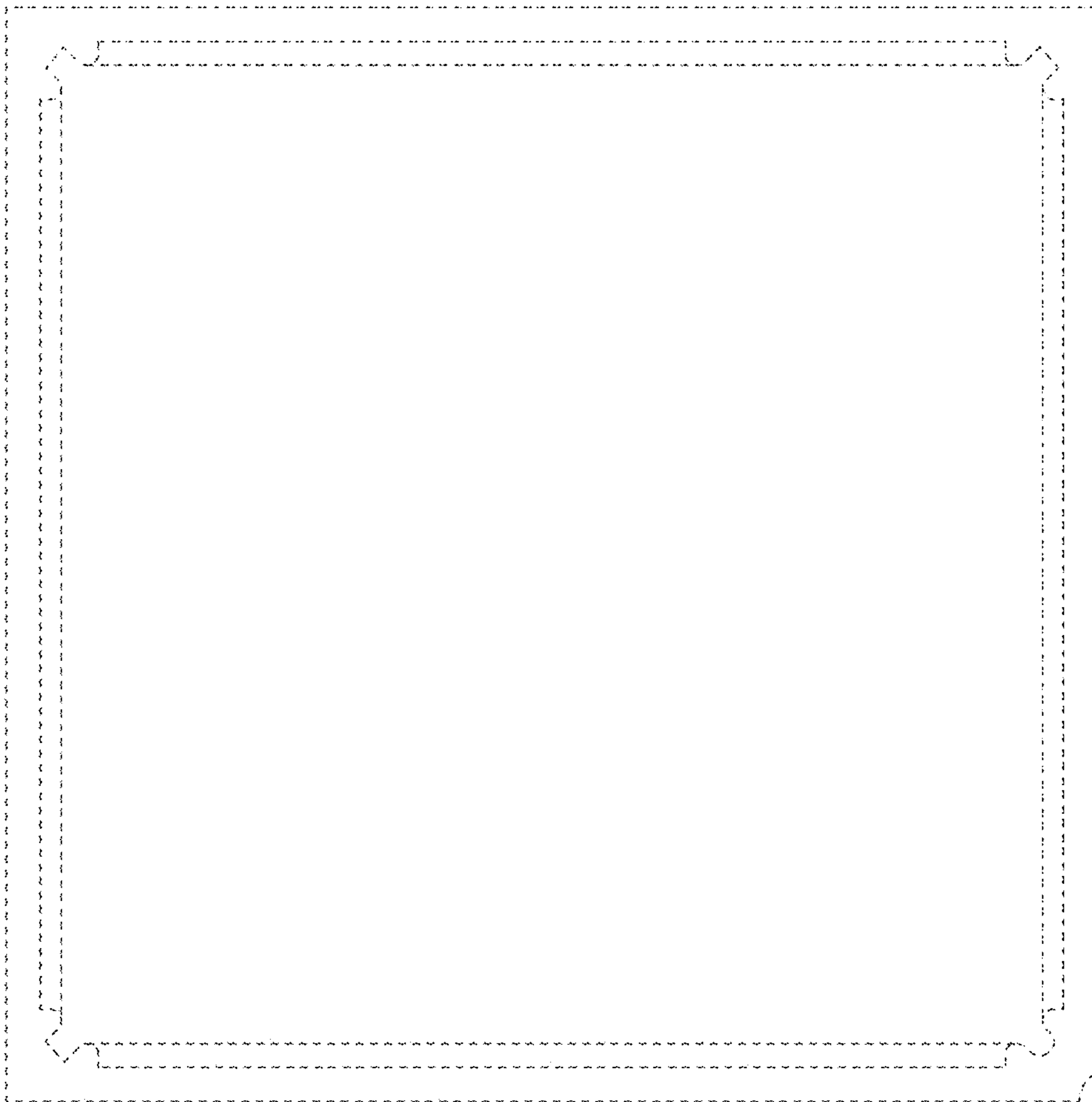

2.3

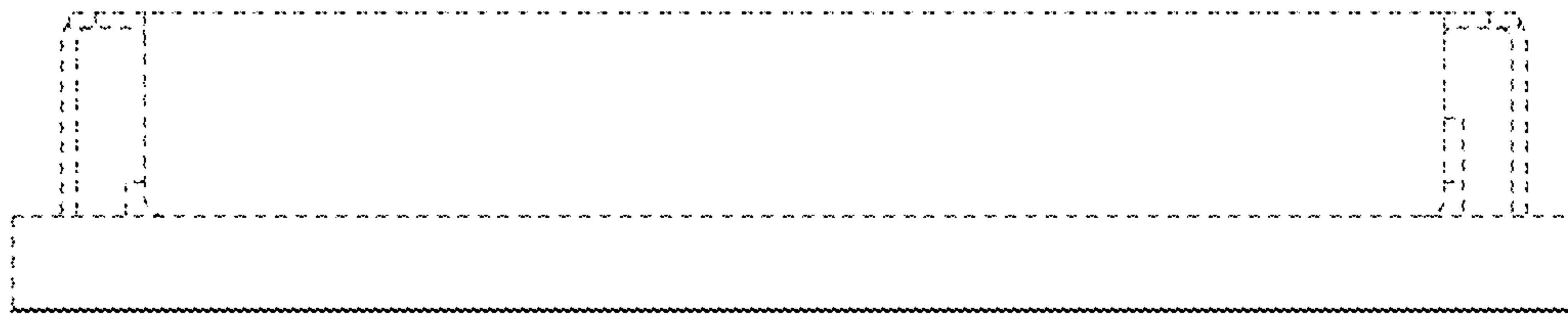

2.4

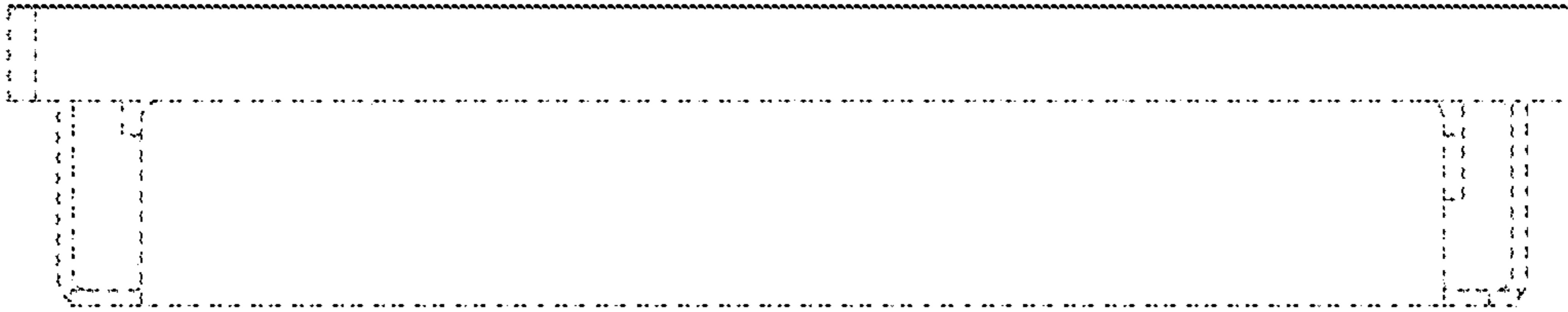

2.5

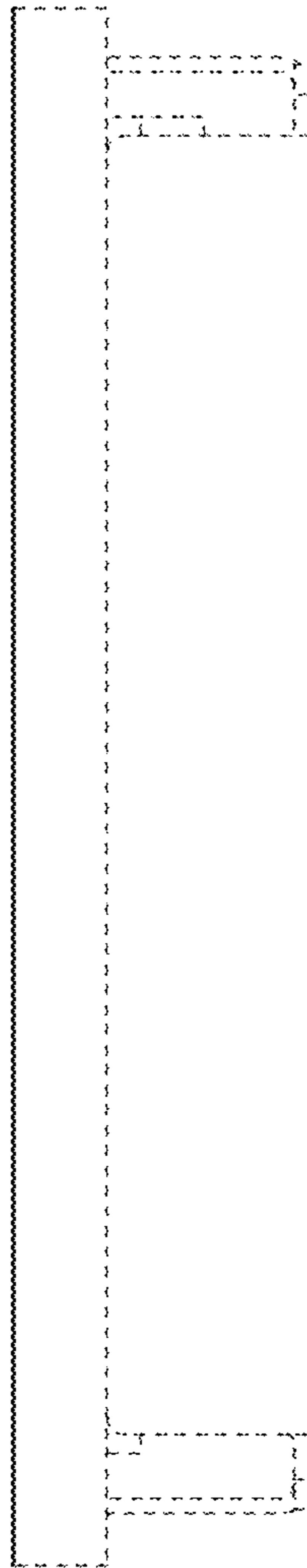

2.6

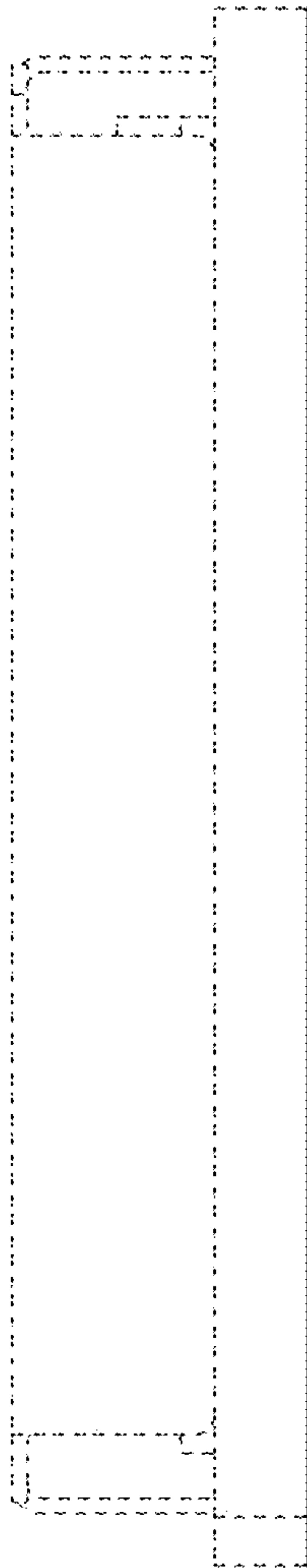

2.7

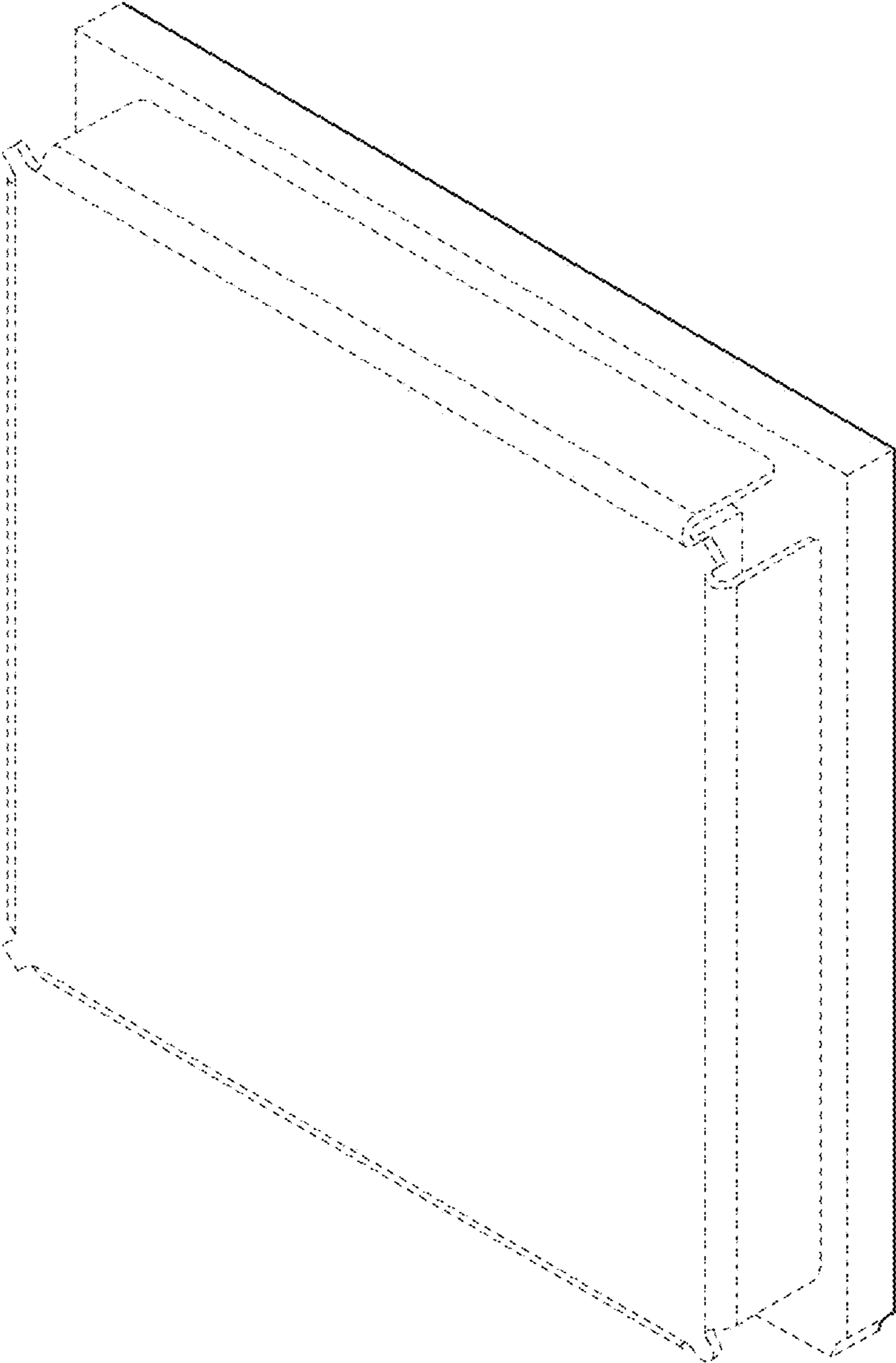

3.1

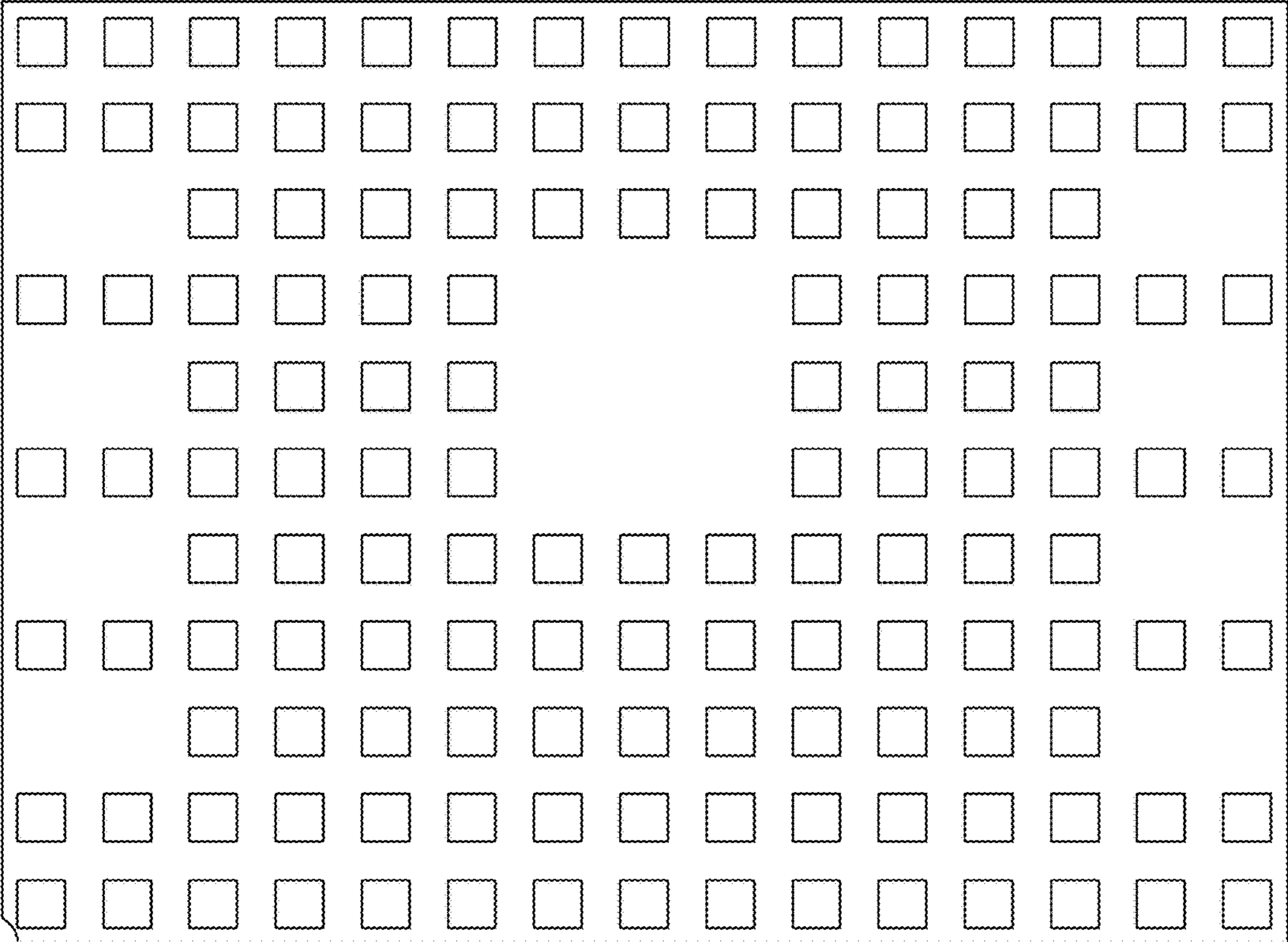

3.2

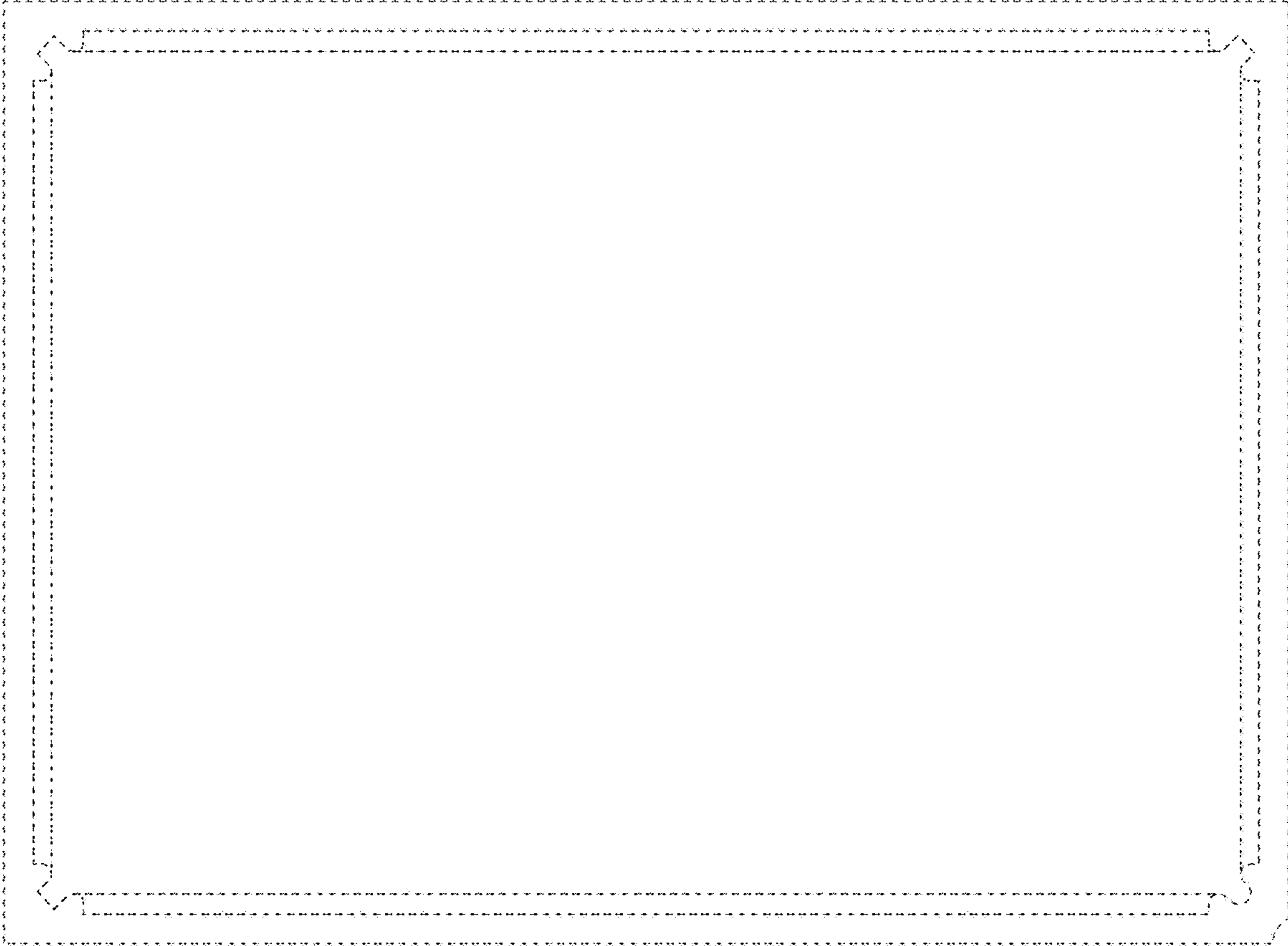

3.3

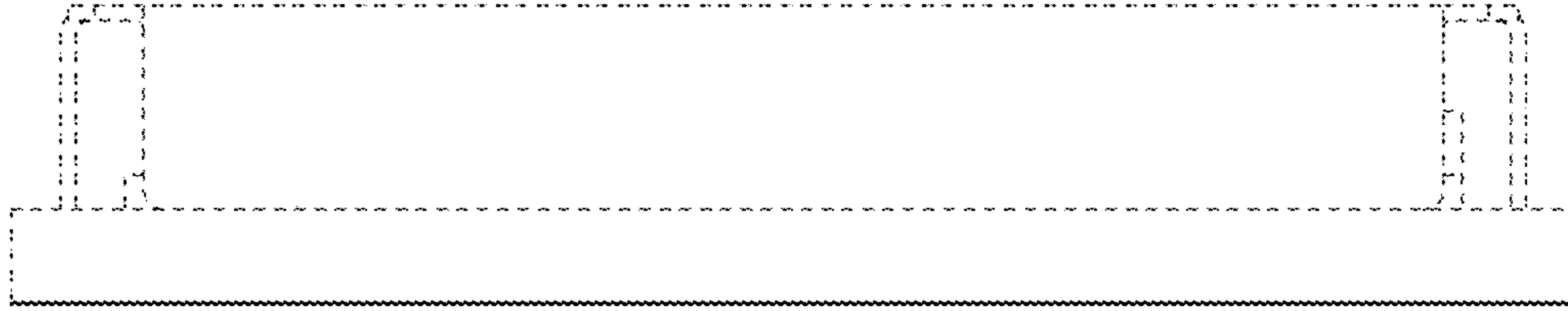

3.4

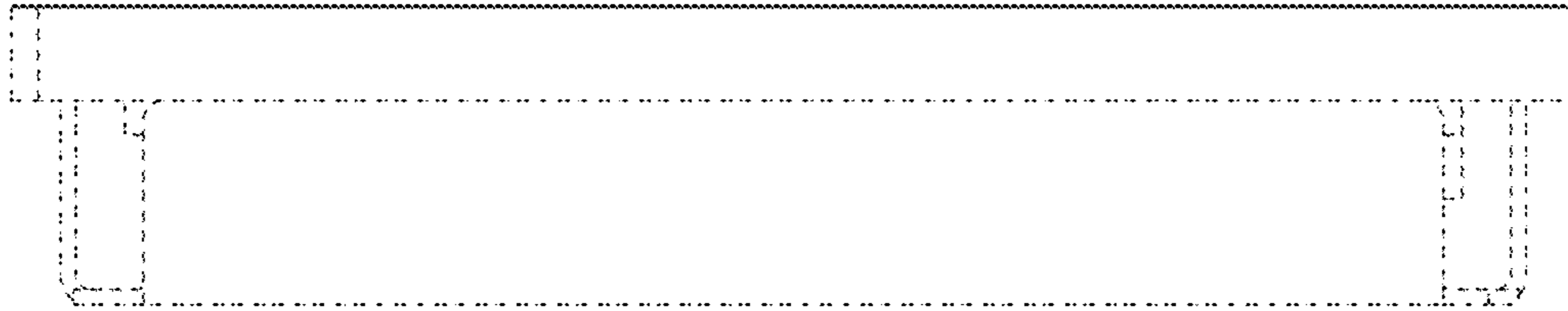

3.5

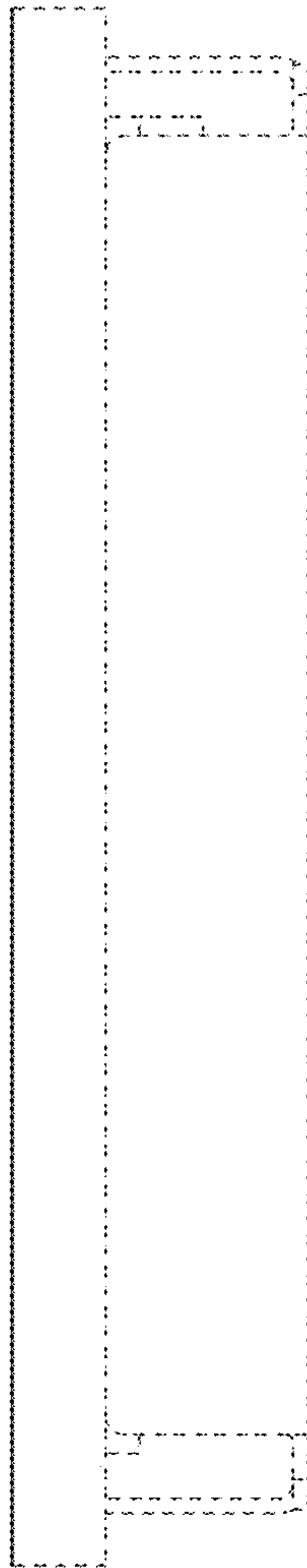

3.6

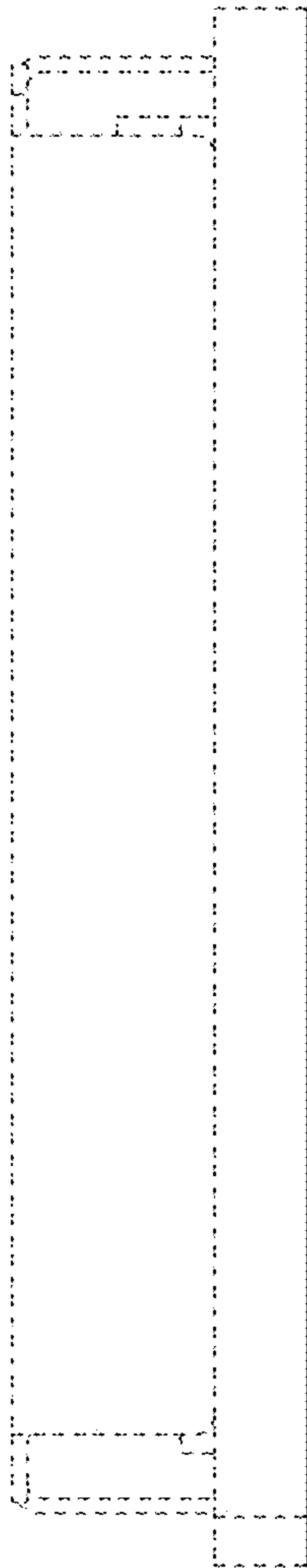

3.7

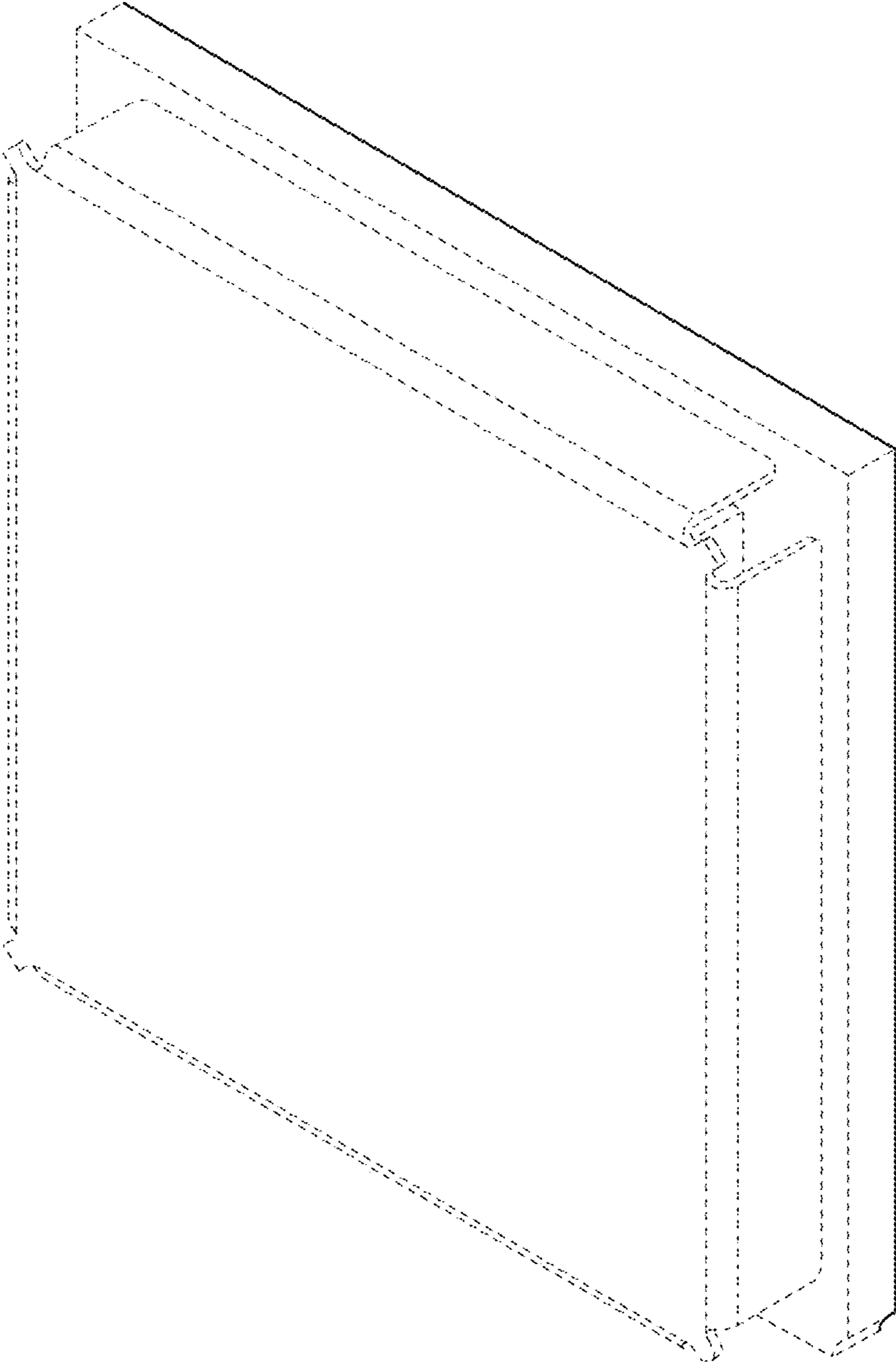

4.1

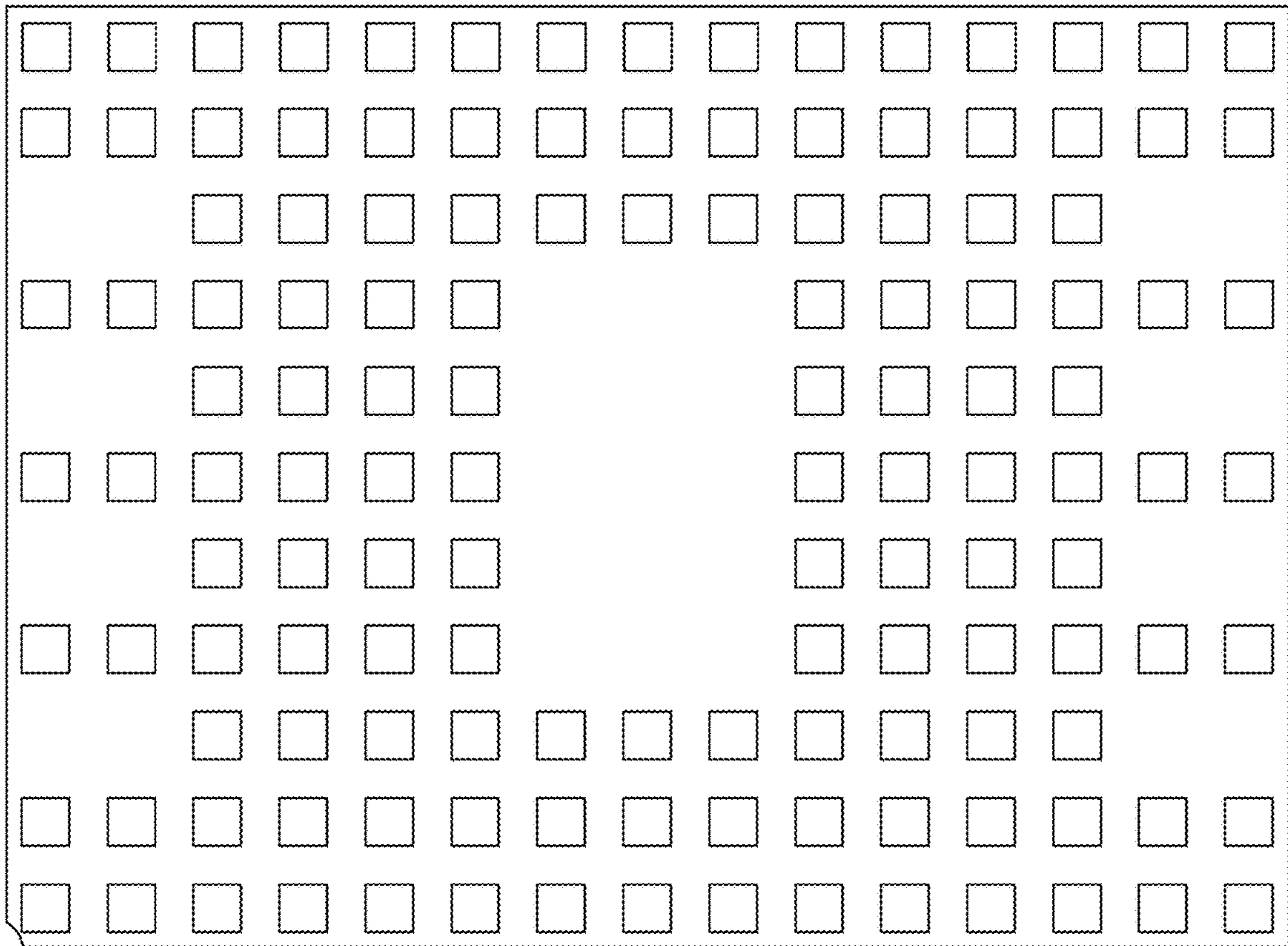

4.2



4.3

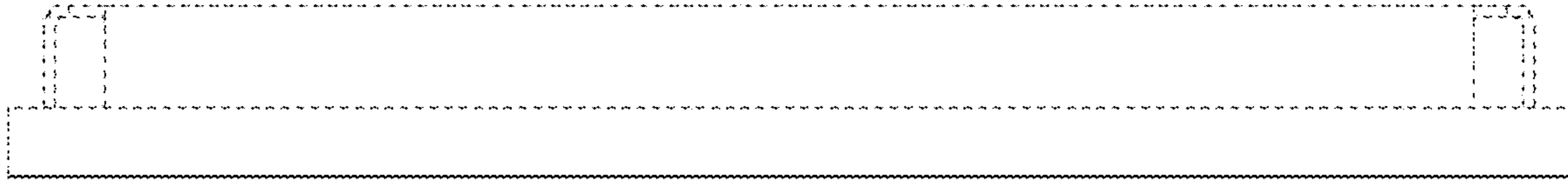

4.4

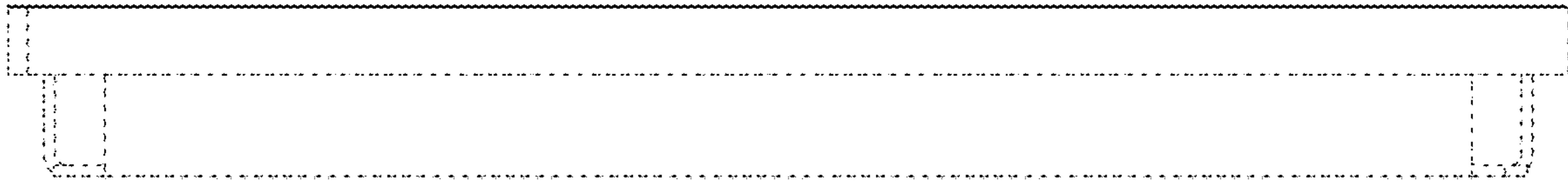

4.5

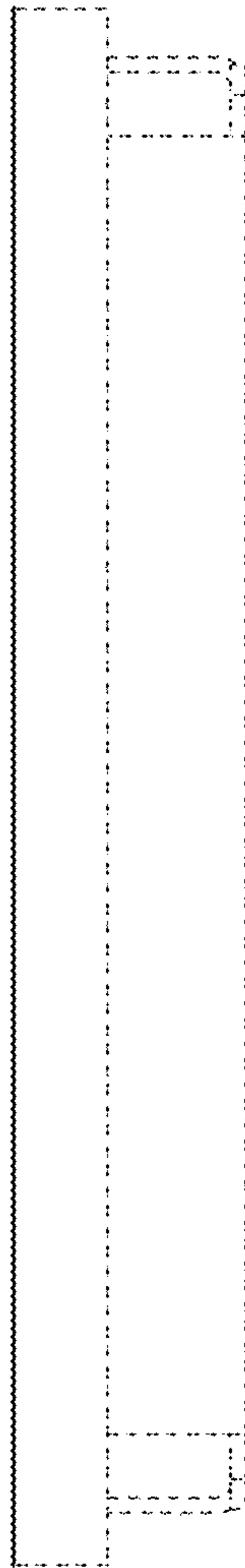

4.6

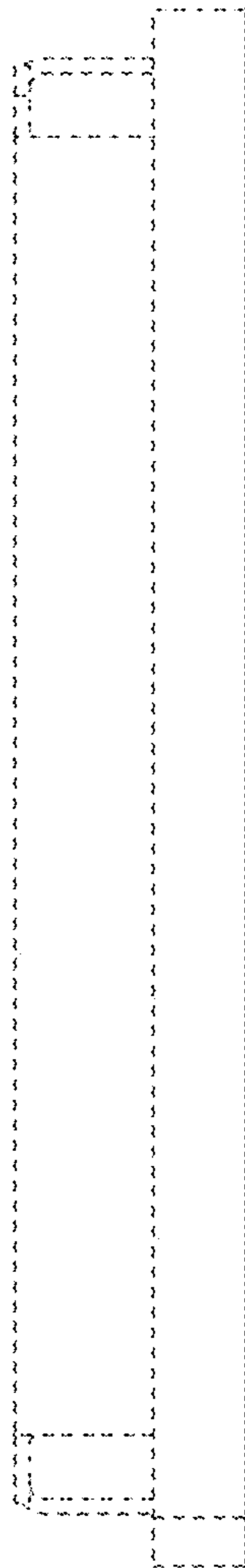

4.7

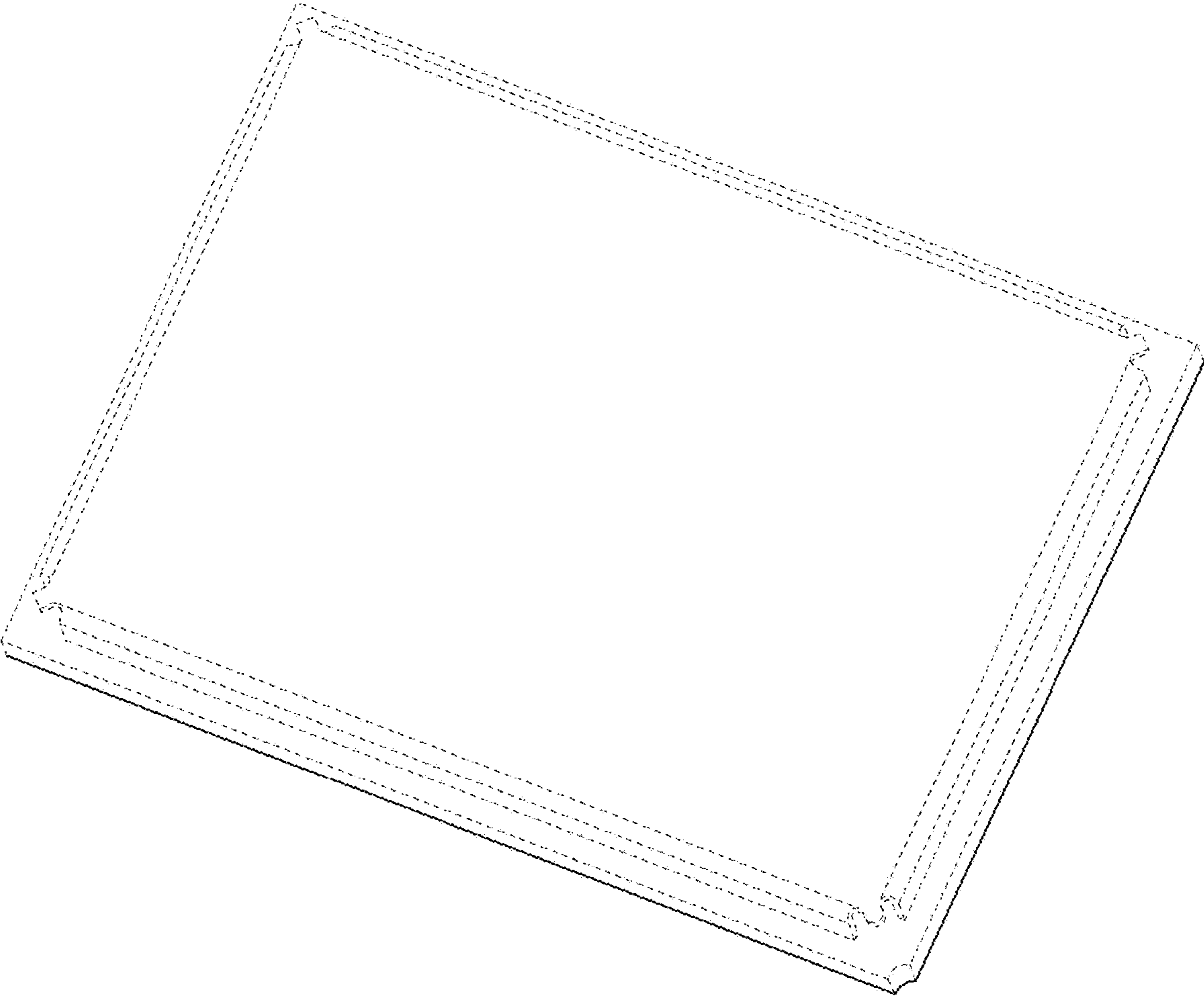

5.1

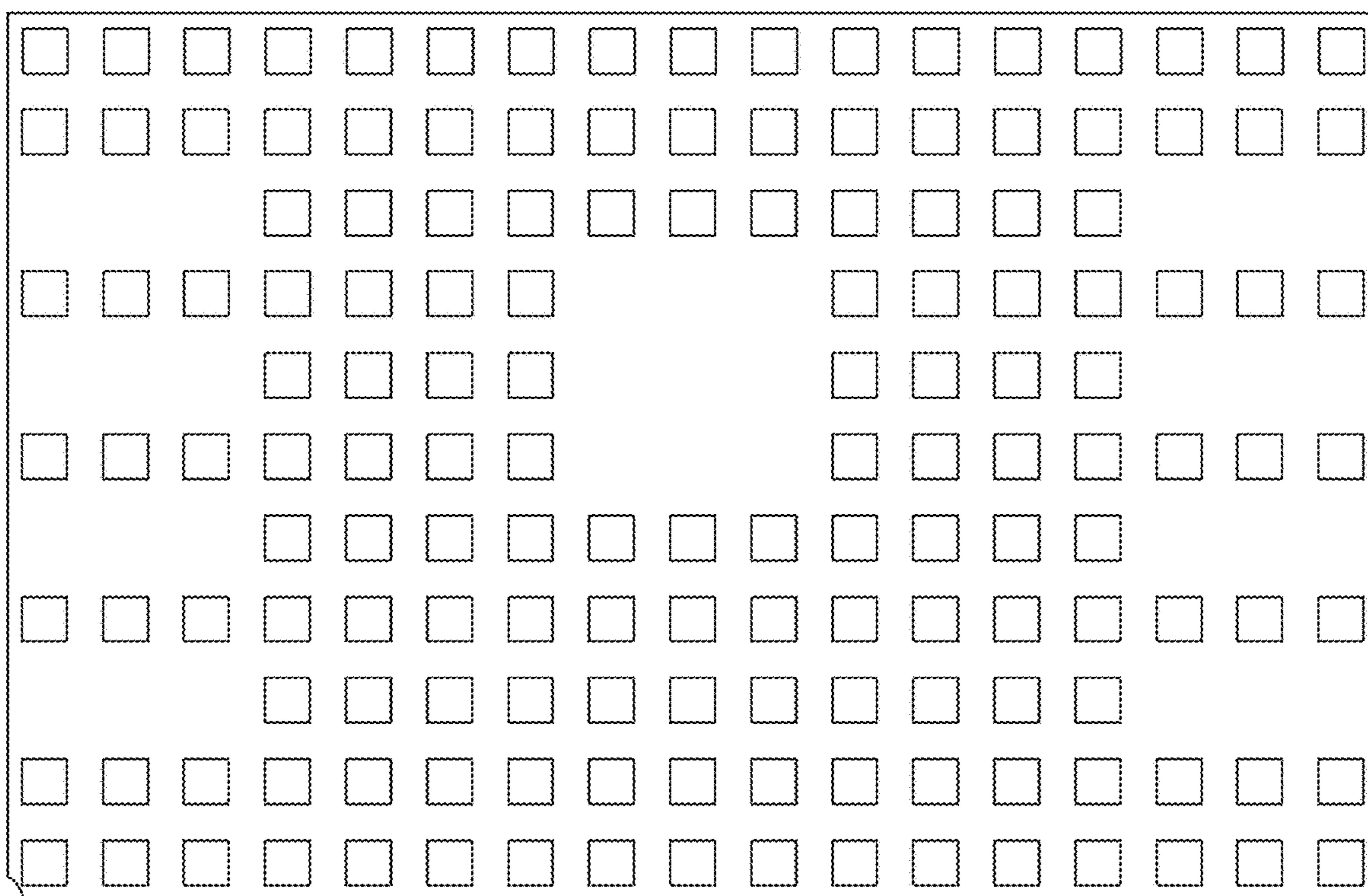

5.2



5.3

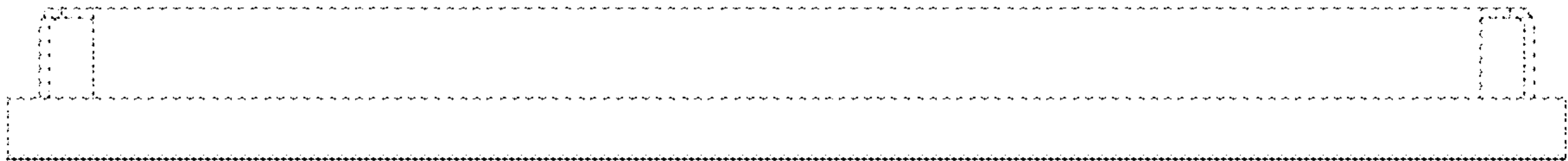

5.4

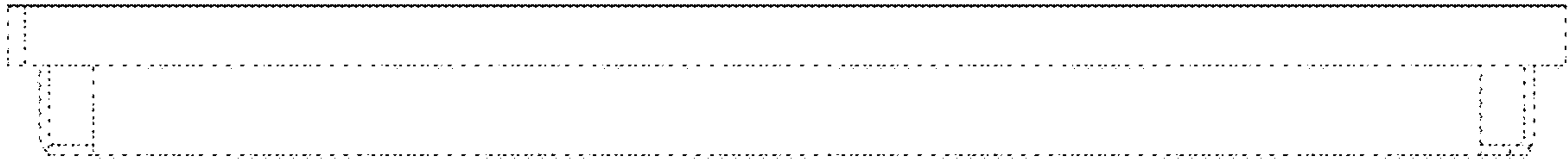

5.5

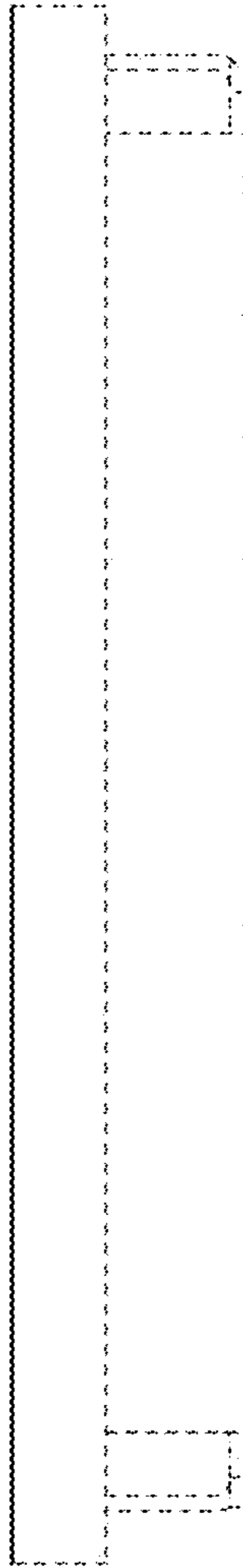

5.6

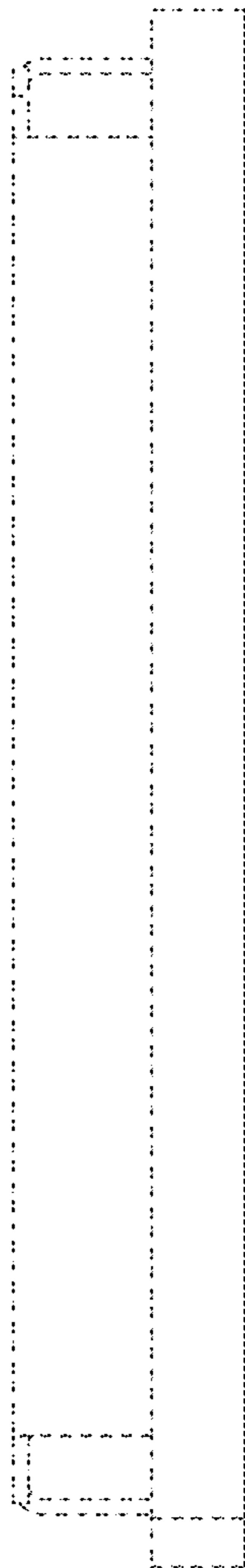

5.7

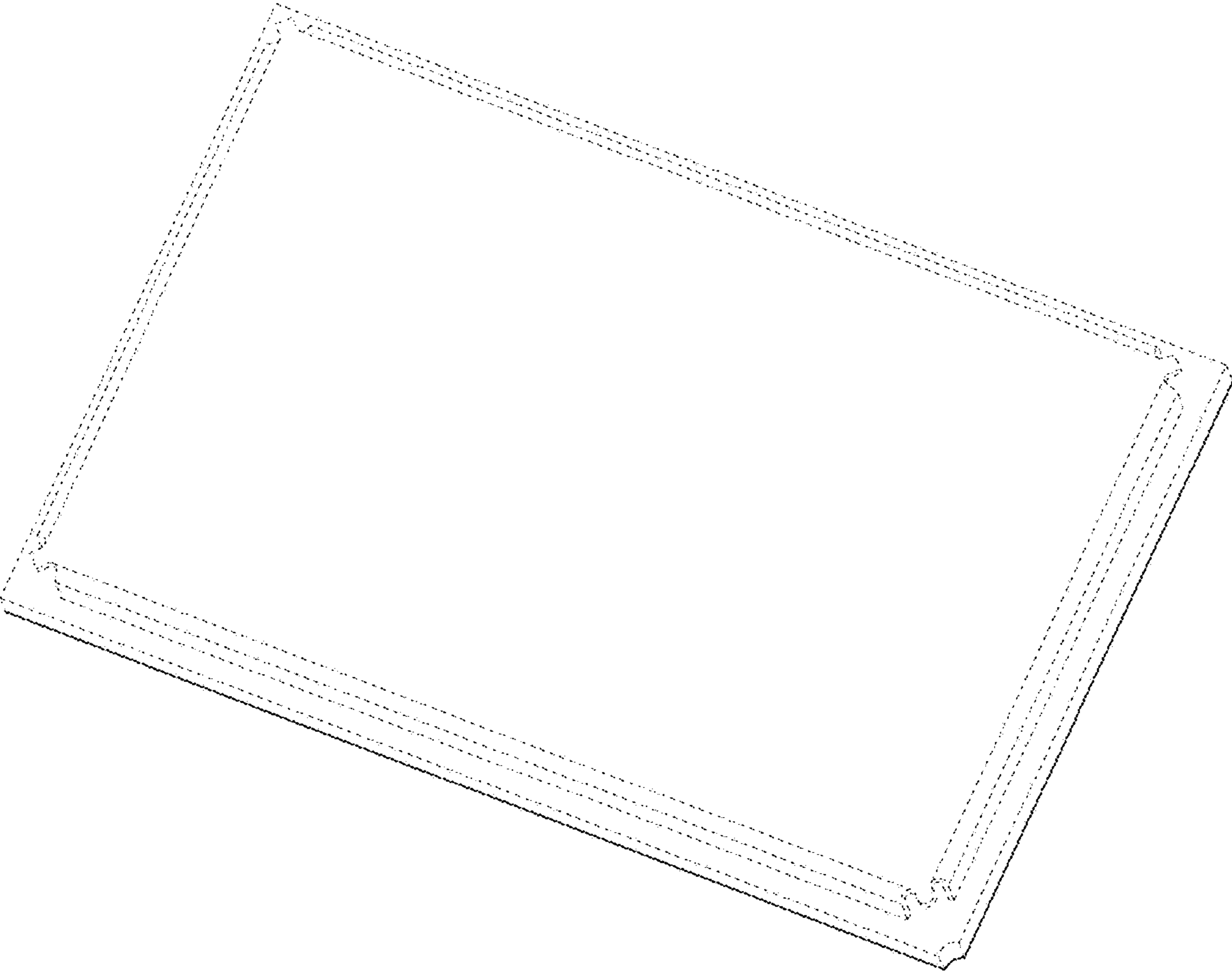

6.1

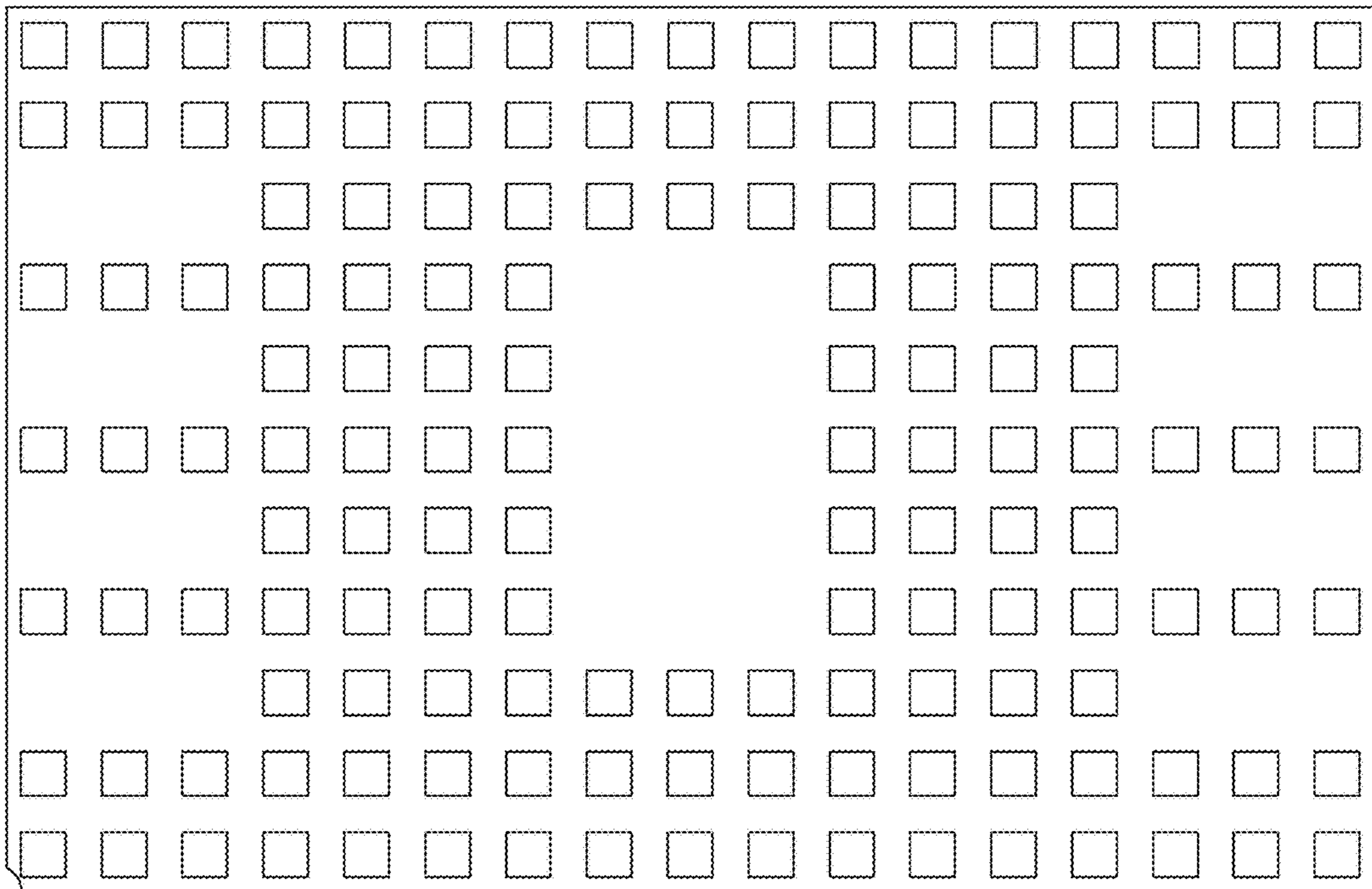

6.2



6.3

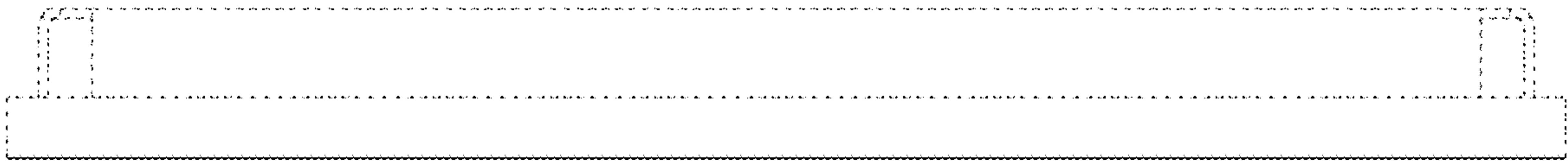

6.4

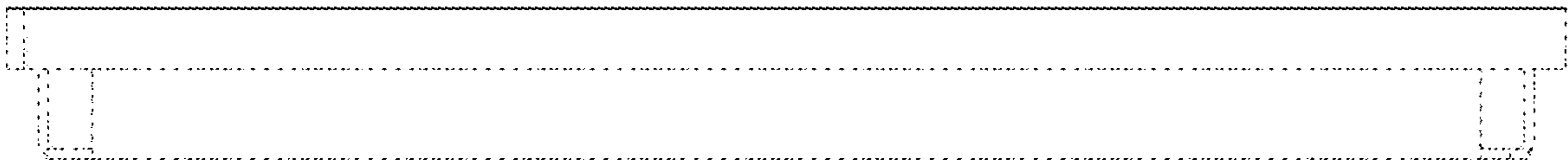

6.5

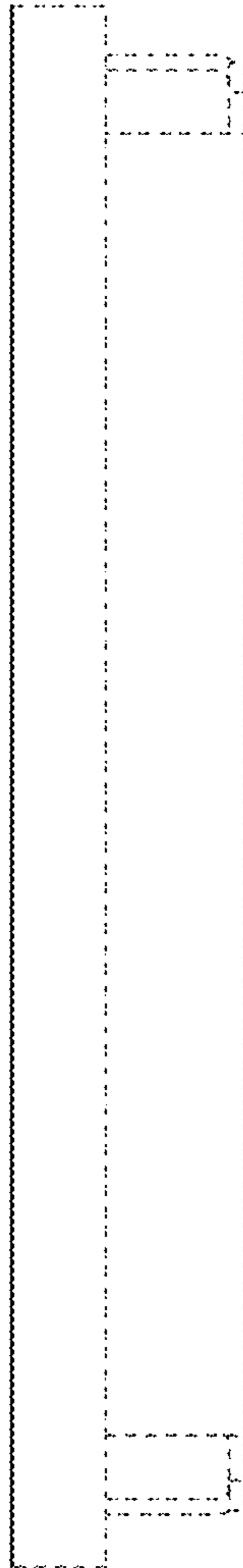

6.6

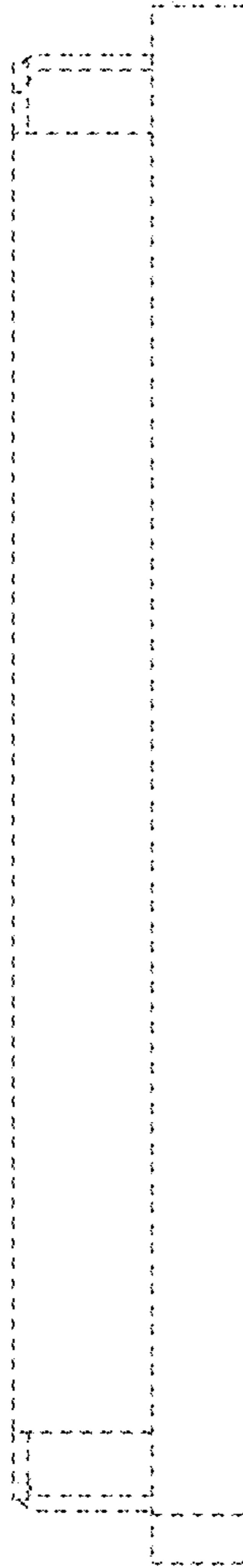

6.7

