



US00D988254S

(12) **United States Design Patent**  
**Katsumoto et al.**

(10) **Patent No.:** **US D988,254 S**

(45) **Date of Patent:** **\*\* Jun. 6, 2023**

(54) **SECONDARY BATTERY**

(71) Applicant: **MURATA MANUFACTURING CO., LTD.**, Kyoto (JP)

(72) Inventors: **Taichi Katsumoto**, Kyoto (JP); **Rie Watanabe**, Kyoto (JP); **Yoshiichi Horikoshi**, Kyoto (JP); **Moriaki Okuno**, Kyoto (JP)

(73) Assignee: **Murata Manufacturing Co., Ltd.**, Kyoto (JP)

(\*\*) Term: **15 Years**

(21) Appl. No.: **29/795,544**

(22) Filed: **Jun. 18, 2021**

(30) **Foreign Application Priority Data**

Dec. 23, 2020 (JP) ..... 2020-027824 D

(51) **LOC (14) Cl.** ..... **13-02**

(52) **U.S. Cl.**  
USPC ..... **D13/103**

(58) **Field of Classification Search**  
USPC ..... D13/102–106, 110, 118–119, 184  
CPC . Y02E 60/10; H01M 2220/30; H01M 50/209;  
H01M 50/213; H01M 50/183; H01M 50/10;  
H01M 50/529; H01M 50/531; H01M 10/0525;  
H01M 10/0436; H01M 10/052; H01M 10/0565;  
H01M 10/30; H01M 10/345; H01M 10/425; H01M 2010/0495;  
B25F 5/02; B25F 5/00; A61B 2017/00734

See application file for complete search history.

(56) **References Cited**

**U.S. PATENT DOCUMENTS**

D388,051 S \* 12/1997 Harada ..... D13/103  
5,904,998 A \* 5/1999 Dopp ..... H01M 4/62  
429/405

D427,141 S \* 6/2000 Luh ..... D13/103  
D457,131 S \* 5/2002 Kitoh ..... D13/103  
6,541,153 B2 \* 4/2003 Hessabi ..... H01M 50/121  
429/161  
D539,216 S \* 3/2007 Hamaguchi ..... D13/103  
D664,092 S \* 7/2012 Gea Suarez ..... D13/103  
8,524,386 B2 \* 9/2013 Petrie ..... H01M 50/216  
429/96

(Continued)

*Primary Examiner* — Nathaniel D. Buckner

(74) *Attorney, Agent, or Firm* — K&L Gates LLP

(57) **CLAIM**

The ornamental design for a secondary battery, as shown and described.

**DESCRIPTION**

FIG. 1 is a perspective view of a secondary battery showing our new design;

FIG. 2 is a front elevational view thereof;

FIG. 3 is a rear elevational view thereof;

FIG. 4 is a left-side elevational view thereof;

FIG. 5 is a right-side elevational view thereof;

FIG. 6 is a top plan view thereof;

FIG. 7 is a bottom plan view thereof;

FIG. 8 is an enlarged view of area 8 designated by the dot-dash broken lines in FIG. 1; and,

FIG. 9 is an enlarged cross sectional view taken along line 9-9 in FIG. 4 in the direction of line 9'-9' in FIG. 2.

The rectangle and splined curve indicated by the dot-dash broken lines shown in FIG. 1 and FIG. 8 illustrate the boundary of enlarged area of the design. The dot-dash broken lines shown in FIG. 1 and FIG. 8 form no part of the claimed design. The even spaced broken lines in FIG. 9 depict portions of the secondary battery that form no part of the claimed design. The dot-dash broken line shown in FIG. 9 indicates the section line and forms no part of the claimed design.

**1 Claim, 8 Drawing Sheets**

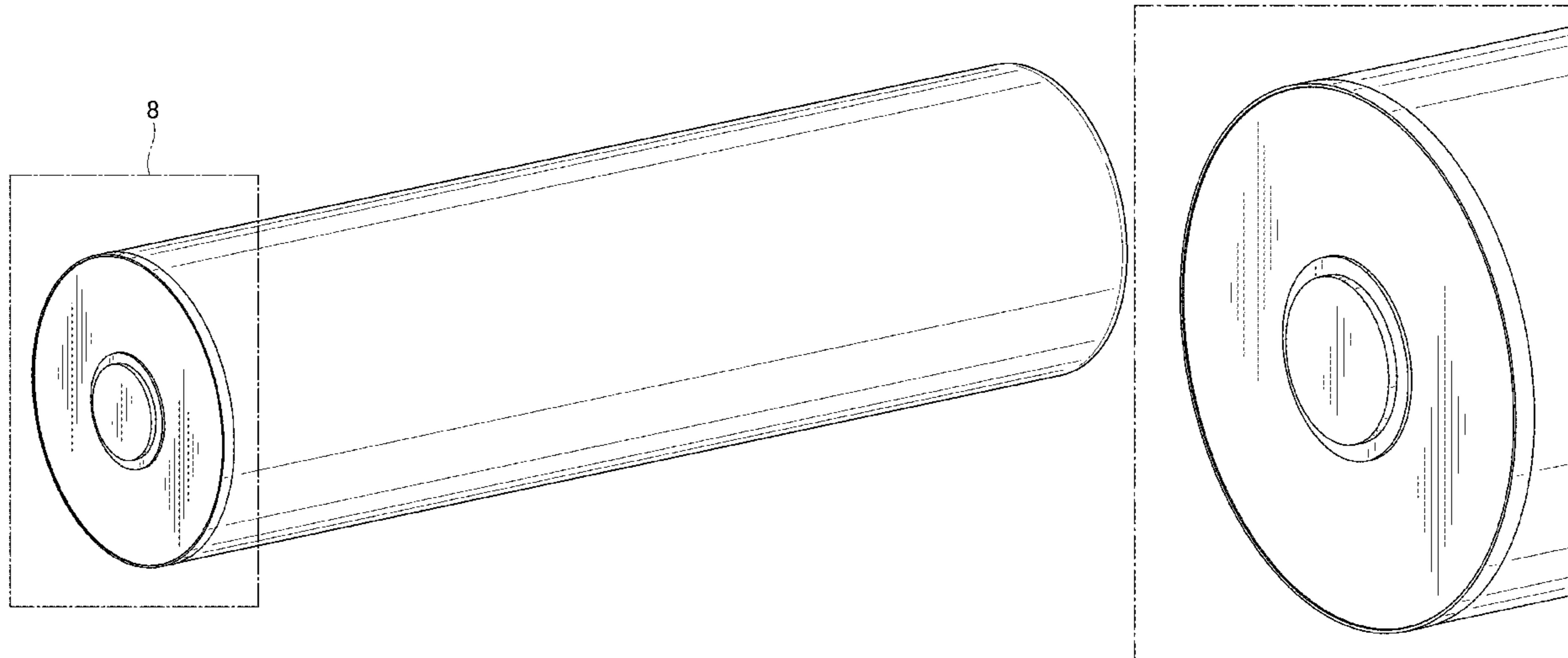

(56)

**References Cited**

U.S. PATENT DOCUMENTS

D720,688 S *	1/2015	Popper .....	D13/103
D740,221 S *	10/2015	Popper .....	D13/103
D850,595 S *	6/2019	Li .....	D23/366
D926,120 S *	7/2021	Richard .....	D13/103
D941,751 S *	1/2022	Boris .....	D13/103

\* cited by examiner

FIG. 1

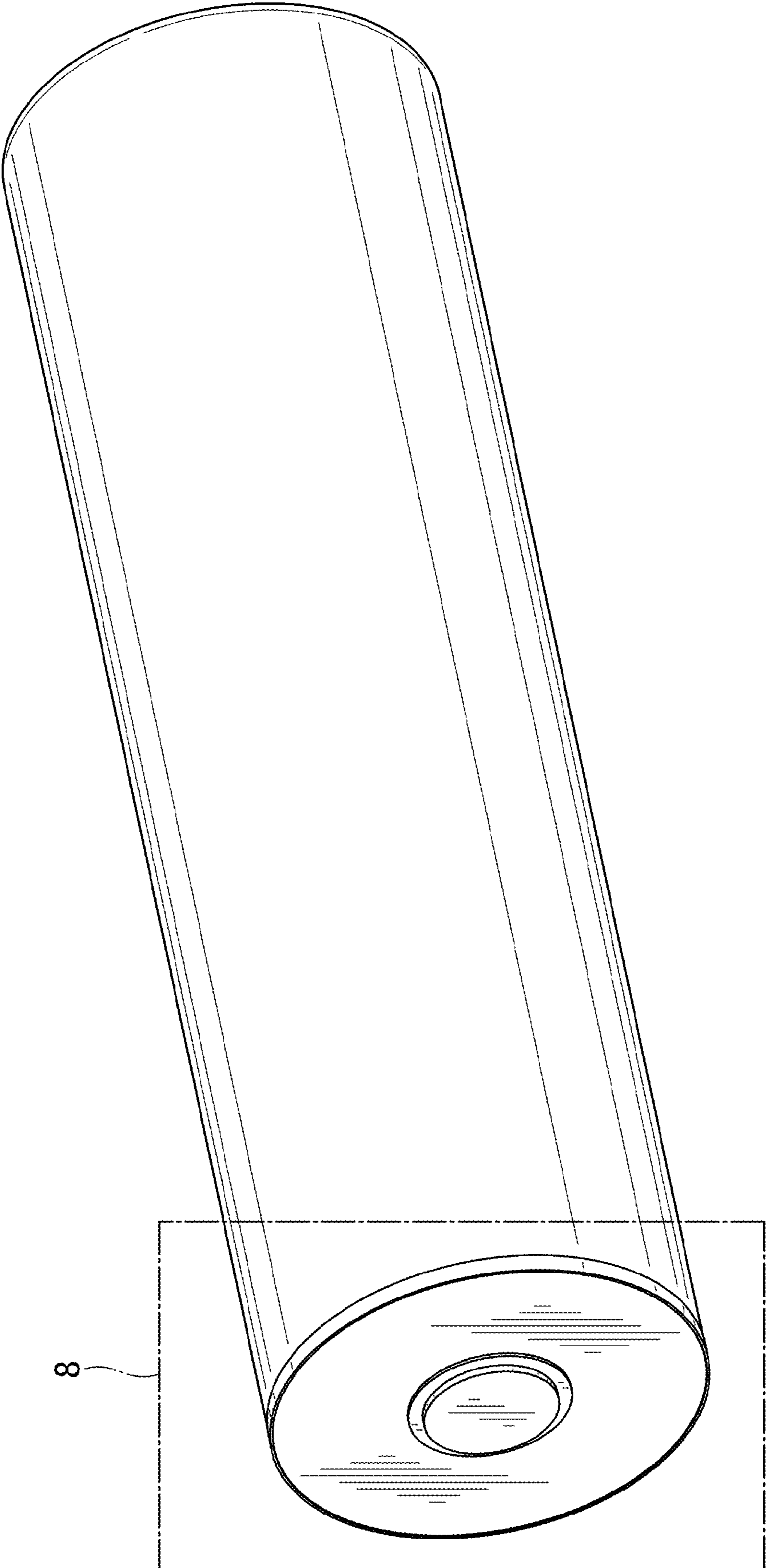

FIG. 2

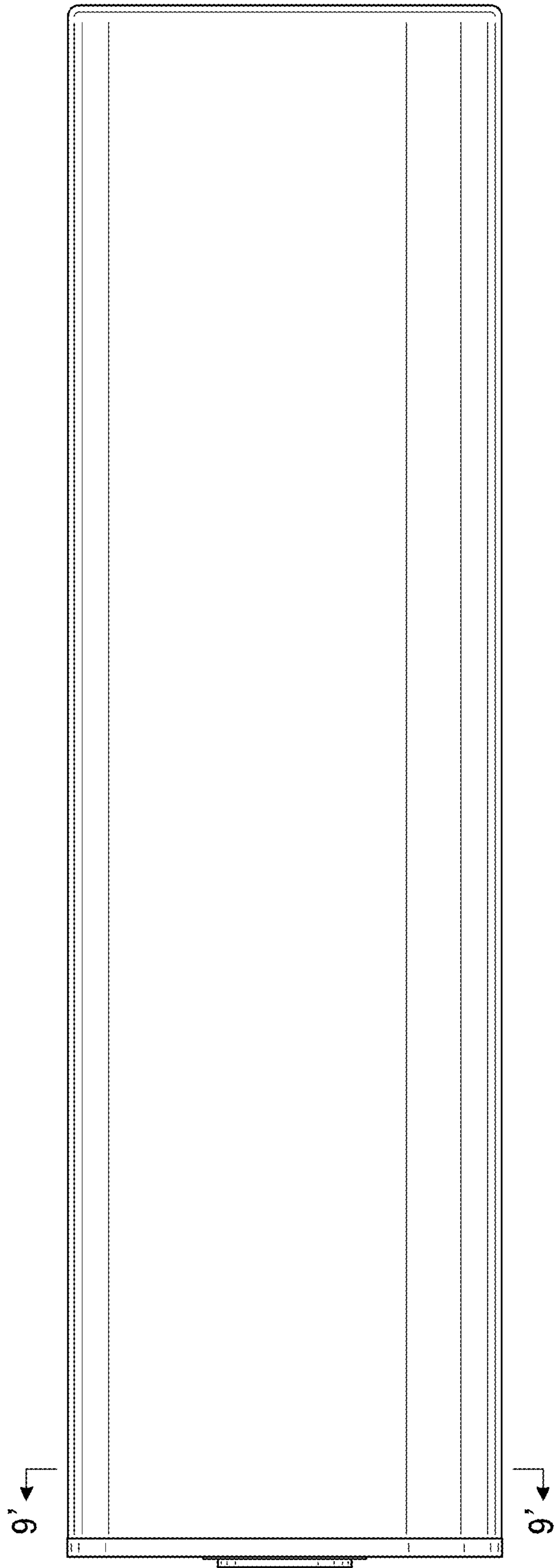

FIG. 3

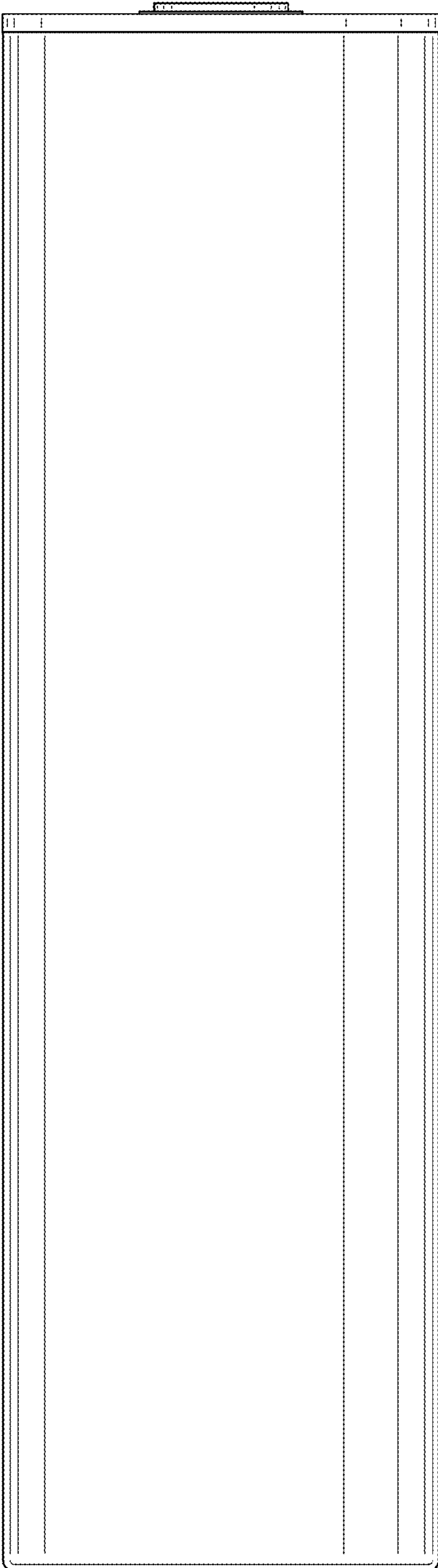

FIG. 5



FIG. 4

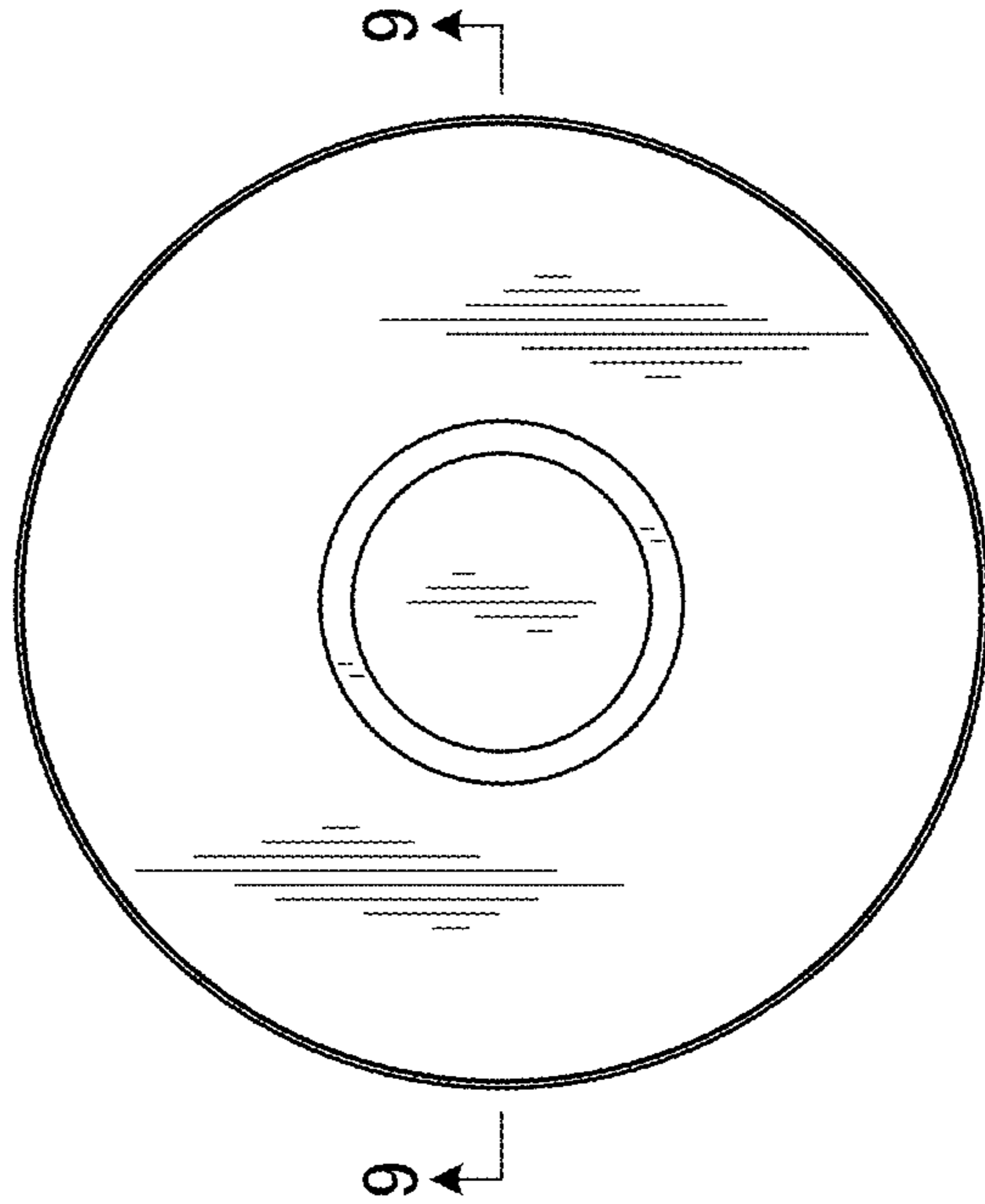

FIG. 6

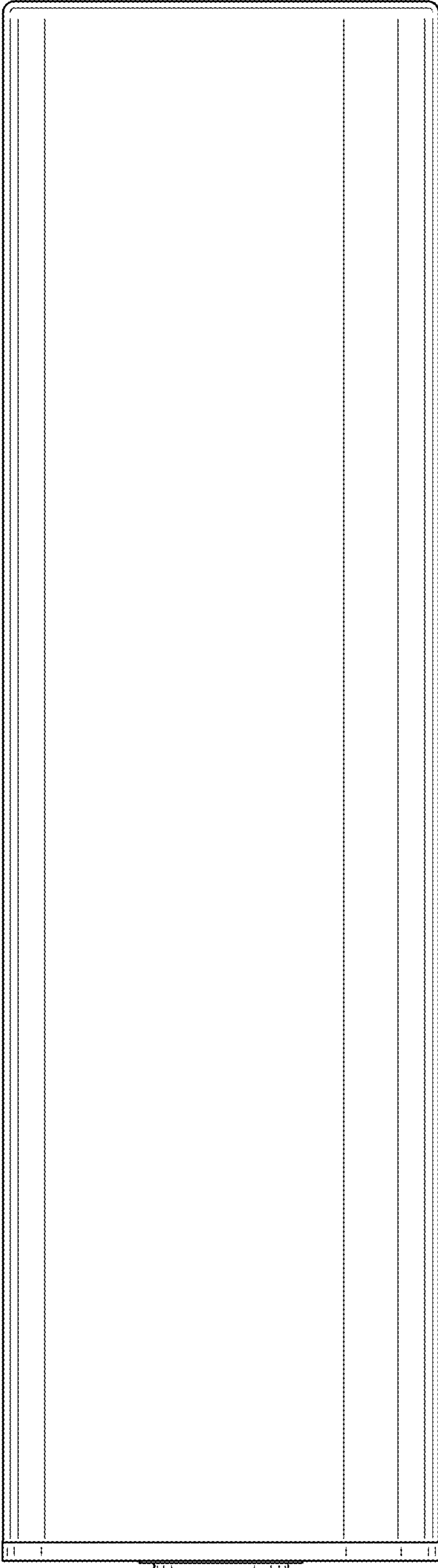

FIG. 7

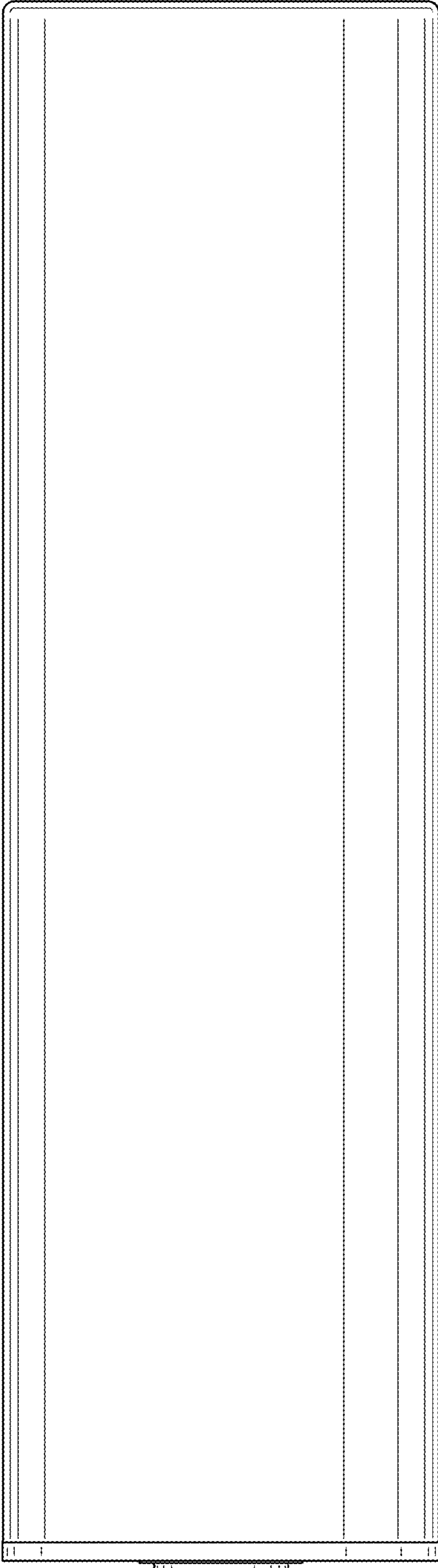



FIG. 8

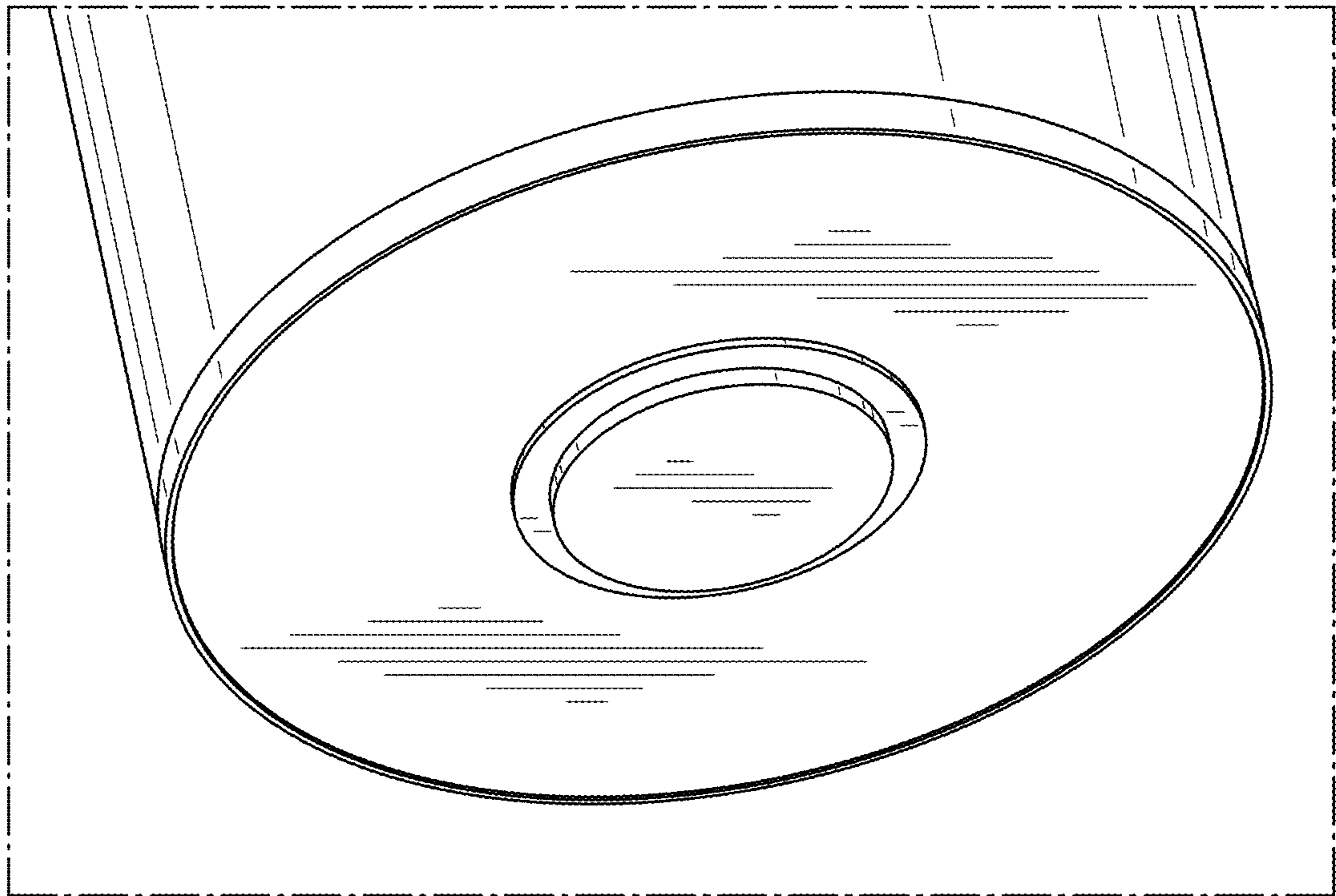

FIG. 9

