



US00D988225S

(12) **United States Design Patent** (10) **Patent No.:** **US D988,225 S**
Abellera et al. (45) **Date of Patent:** **** Jun. 6, 2023**

(54) **MECHANICAL REMOTE CONTROL FOR A MARINE VESSEL**

(71) Applicant: **Brunswick Corporation**, Mettawa, IL (US)

(72) Inventors: **Ryan C. Abellera**, Fond du Lac, WI (US); **Todd D. Dannenberg**, Fond du Lac, WI (US); **John I. S. Park**, Fond du Lac, WI (US)

(73) Assignee: **BRUNSWICK CORPORATION**, Mettawa, IL (US)

(**) Term: **15 Years**

(21) Appl. No.: **29/755,879**

(22) Filed: **Oct. 23, 2020**

(51) **LOC (14) Cl.** **12-06**

(52) **U.S. Cl.**
USPC **D12/317**

(58) **Field of Classification Search**
USPC D12/317, 174, 178–180; D13/162, 134, D13/168, 169, 173; D10/49
CPC B63H 21/21; B63H 21/213; B63H 21/22; B63H 21/216
See application file for complete search history.

(56) **References Cited**

U.S. PATENT DOCUMENTS

5,967,867	A	10/1999	Rinzaki et al.	
6,280,269	B1	8/2001	Gaynor	
D497,347	S *	10/2004	Iekura	D13/168
D502,148	S	2/2005	Iekura	
D510,311	S	10/2005	Rick et al.	
D510,556	S	10/2005	Rick et al.	
D510,557	S	10/2005	Rick et al.	
D510,558	S	10/2005	Rick et al.	
6,979,278	B2	12/2005	Rick et al.	
D554,080	S *	10/2007	Iekura	D13/168

D554,596	S	11/2007	Iekura	
7,452,254	B2	11/2008	Watanabe et al.	
D592,605	S	5/2009	Iekura	
D663,252	S *	7/2012	Bondesson	D12/317
D663,253	S	7/2012	Bondesson	
D689,423	S *	9/2013	Park	D12/317
D689,424	S *	9/2013	Park	D12/317

(Continued)

OTHER PUBLICATIONS

Mercury marine.com, “Single Engine Controls”, <https://www.mercurymarine.com/en/us/gauges-and-controls/single-engine-controls/>, website last visited Oct. 20, 2020.

(Continued)

Primary Examiner — Cynthia M. Chin

(74) *Attorney, Agent, or Firm* — Andrus Intellectual Property Law, LLP

(57) **CLAIM**

The ornamental design for a mechanical remote control for a marine vessel, as shown and described.

DESCRIPTION

FIG. 1 is a rear perspective view of a mechanical remote control for a marine vessel according to our new and ornamental design;

FIG. 2 is a side view thereof;

FIG. 3 is an opposite side view thereof;

FIG. 4 is a rear view thereof;

FIG. 5 is a front view thereof;

FIG. 6 is a top view thereof; and,

FIG. 7 is a bottom view thereof.

The dash-dot broken lines immediately adjacent the shaded areas represent the bounds of the claim and all other broken lines represent aspects of the mechanical remote control for a marine vessel that form not part of the claimed design. None of the broken lines form a part of the claim.

1 Claim, 6 Drawing Sheets

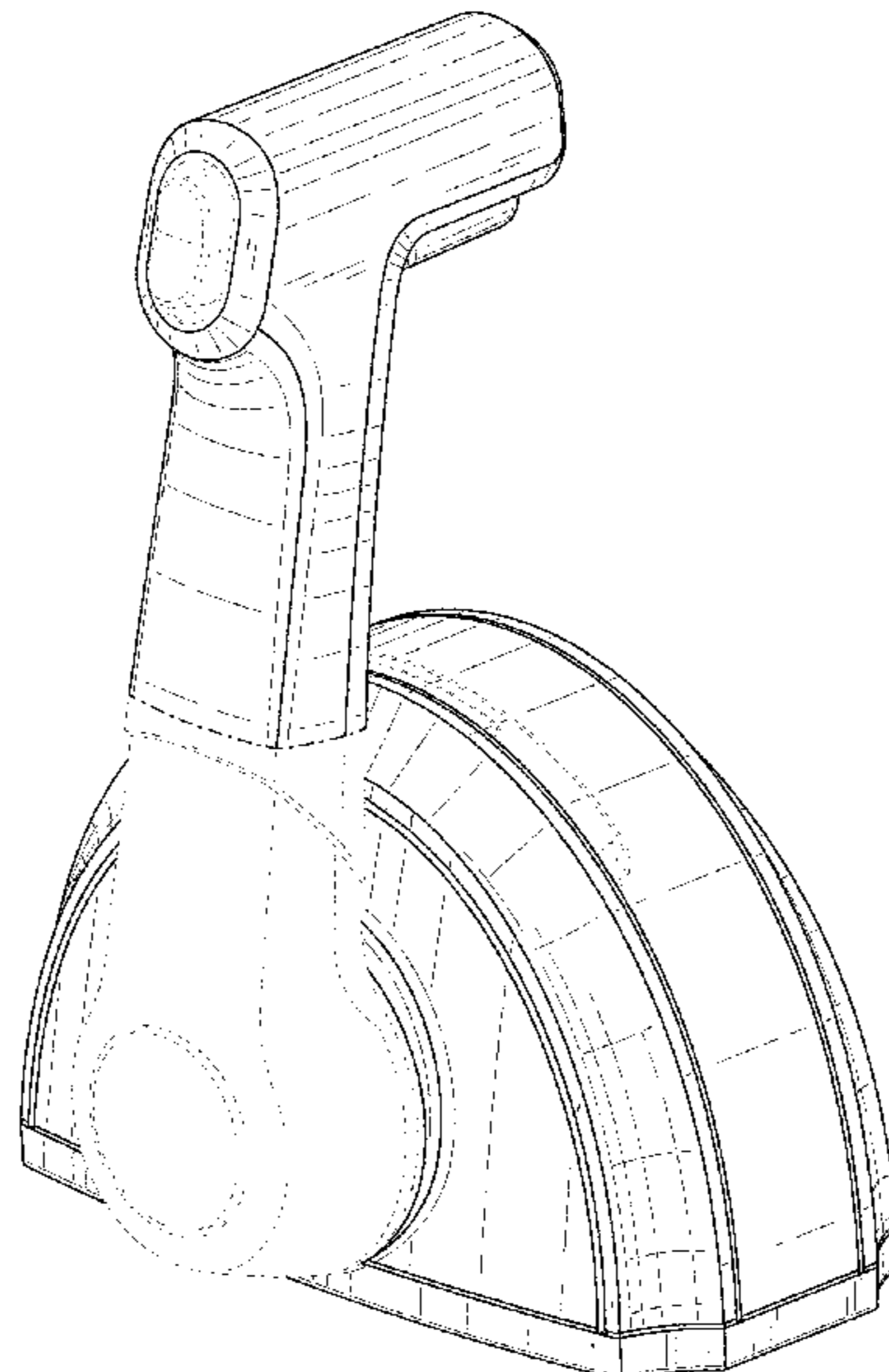

(56)

References Cited

U.S. PATENT DOCUMENTS

D710,781	S	*	8/2014	Park	D12/317
D746,758	S	*	1/2016	Dannenberg	D12/317
D834,492	S	*	11/2018	Uchiyama	D12/317
D834,493	S		11/2018	Uchiyama et al.		
D888,646	S	*	6/2020	Richards	D12/317
D890,678	S	*	7/2020	Neathery	D12/317
D890,679	S	*	7/2020	Neathery	D12/317
D901,367	S		11/2020	Ohashi et al.		
D905,613	S	*	12/2020	Ohashi	D12/317
D928,692	S	*	8/2021	Richards	D12/317
D938,888	S	*	12/2021	Richards	D12/317
D951,168	S	*	5/2022	Abellera	D13/168
D967,270	S		10/2022	Abellera et al.		
D967,271	S		10/2022	Abellera et al.		
2005/0090368	A1		4/2005	Rick et al.		
2007/0249244	A1		10/2007	Watanabe et al.		
2018/0244362	A1		8/2018	Nolan et al.		
2022/0033046	A1		2/2022	Despineux et al.		

OTHER PUBLICATIONS

Mercury marine.com, “Single Engine Controls: Side Mount”, <https://www.mercurymarine.com/en/us/gauges-and-controls/single-engine-controls/side-mount/>, website last visited Oct. 20, 2020.

Mercury marine.com, “Single Engine Controls: Console Mount”, <https://www.mercurymarine.com/en/us/gauges-and-controls/single-engine-controls/console-mount/>, website last visited Oct. 20, 2020.

Mercury marine.com, “Single Engine Controls: Flush/Panel Mount”, <https://www.mercurymarine.com/en/us/gauges-and-controls/single-engine-controls/flushpanel-mount/>, website last visited Oct. 20, 2020.

Mercury marine.com, “Multiple Engine Controls”, <https://www.mercurymarine.com/en/us/gauges-and-controls/multiple-engine-controls/>, website last visited Oct. 20, 2020.

Mercury marine.com, “Multiple Engine Controls: Console Mount”, <https://www.mercurymarine.com/en/us/gauges-and-controls/multiple-engine-controls/console-mount/>, website last visited Oct. 20, 2020.

Mercury marine.com, “Multiple Engine Controls: Yacht Controls”, <https://www.mercurymarine.com/en/us/gauges-and-controls/multiple-engine-controls/yacht-controls/>, website last visited Oct. 20, 2020.

Mercury marine.com, “Multiple Engine Controls: Joystick Control”, <https://www.mercurymarine.com/en/us/gauges-and-controls/multiple-engine-controls/joystick-control/>, website last visited Oct. 20, 2020.

* cited by examiner

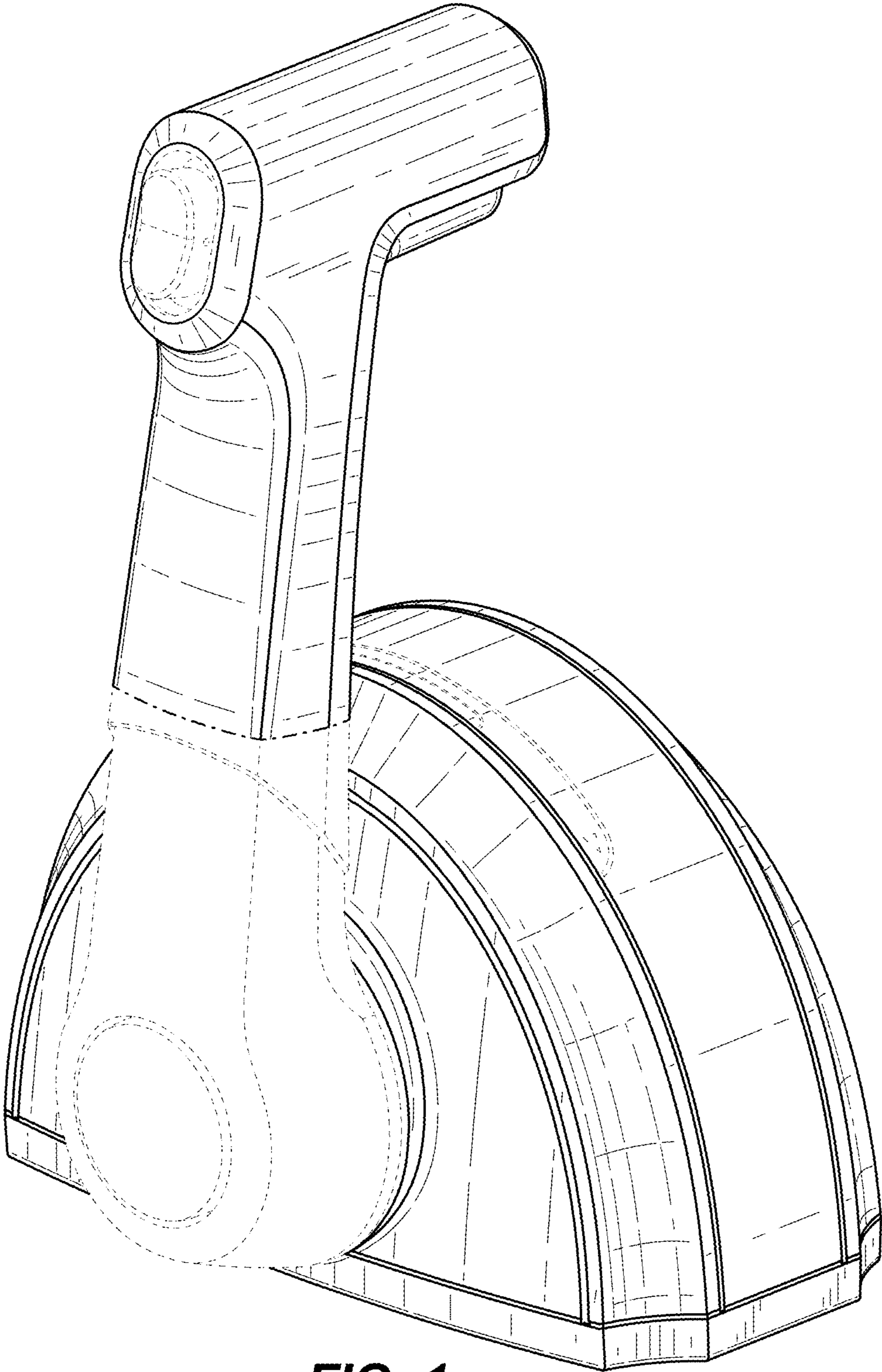

FIG. 1

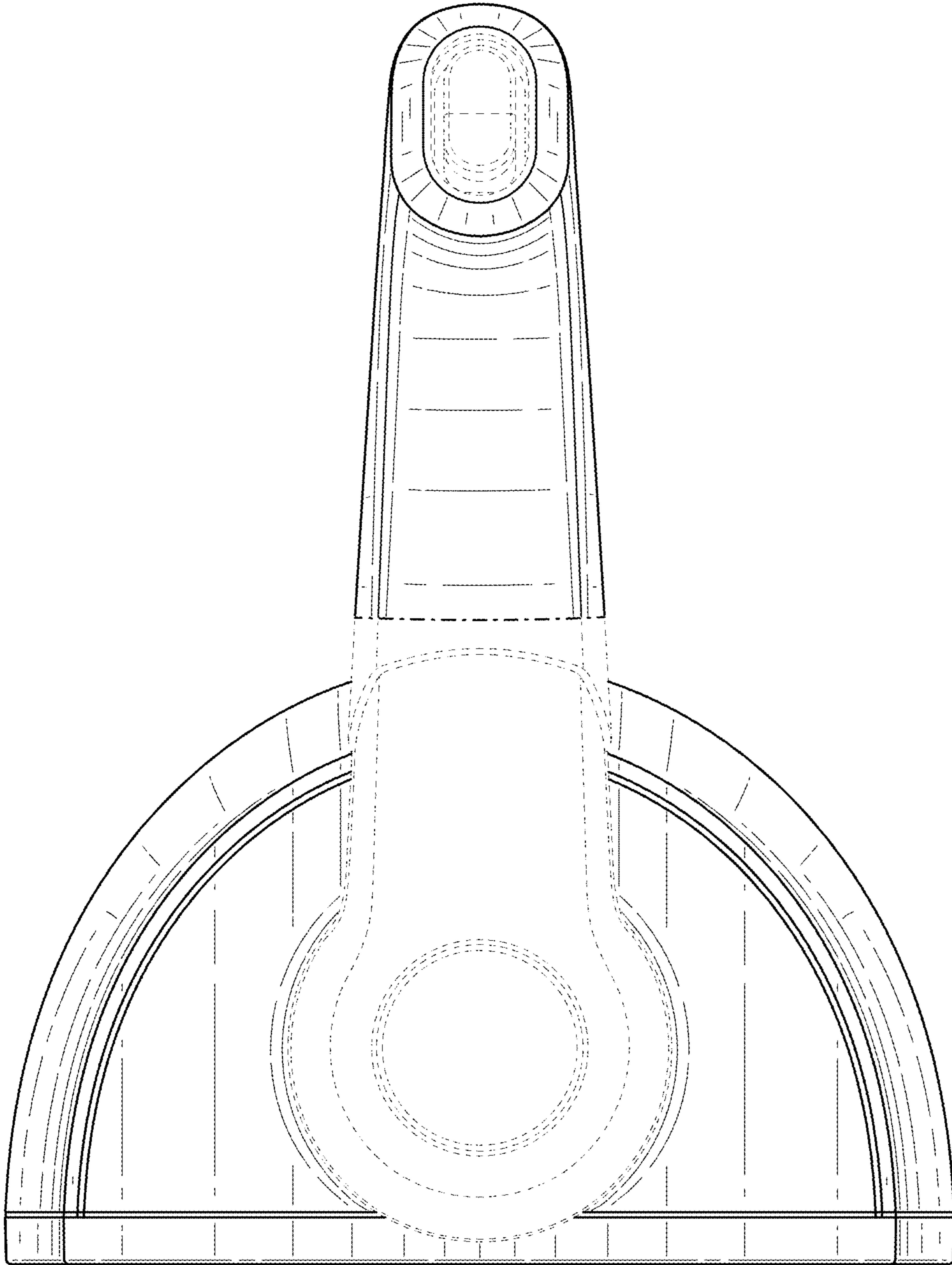

FIG. 2

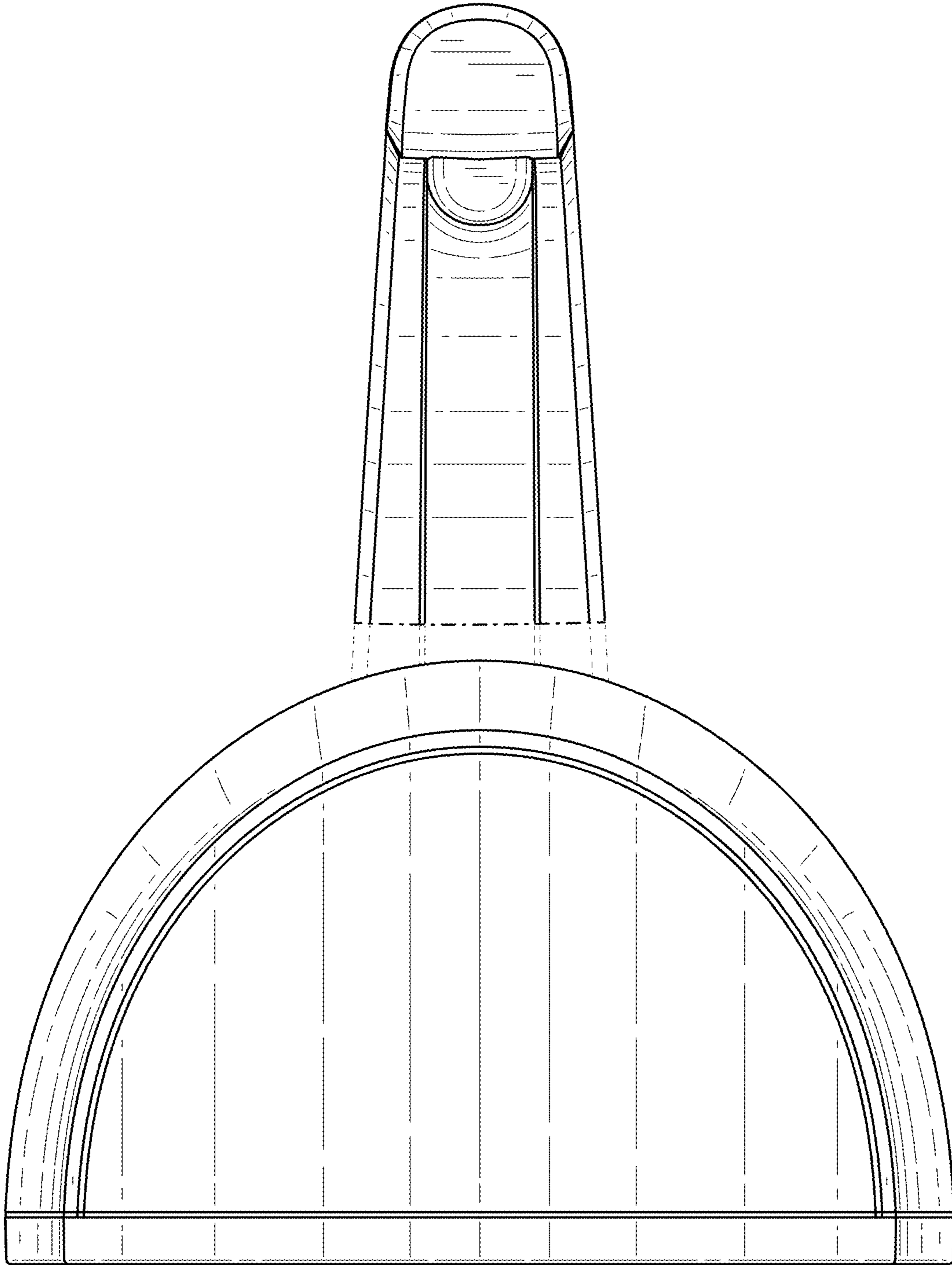

FIG. 3

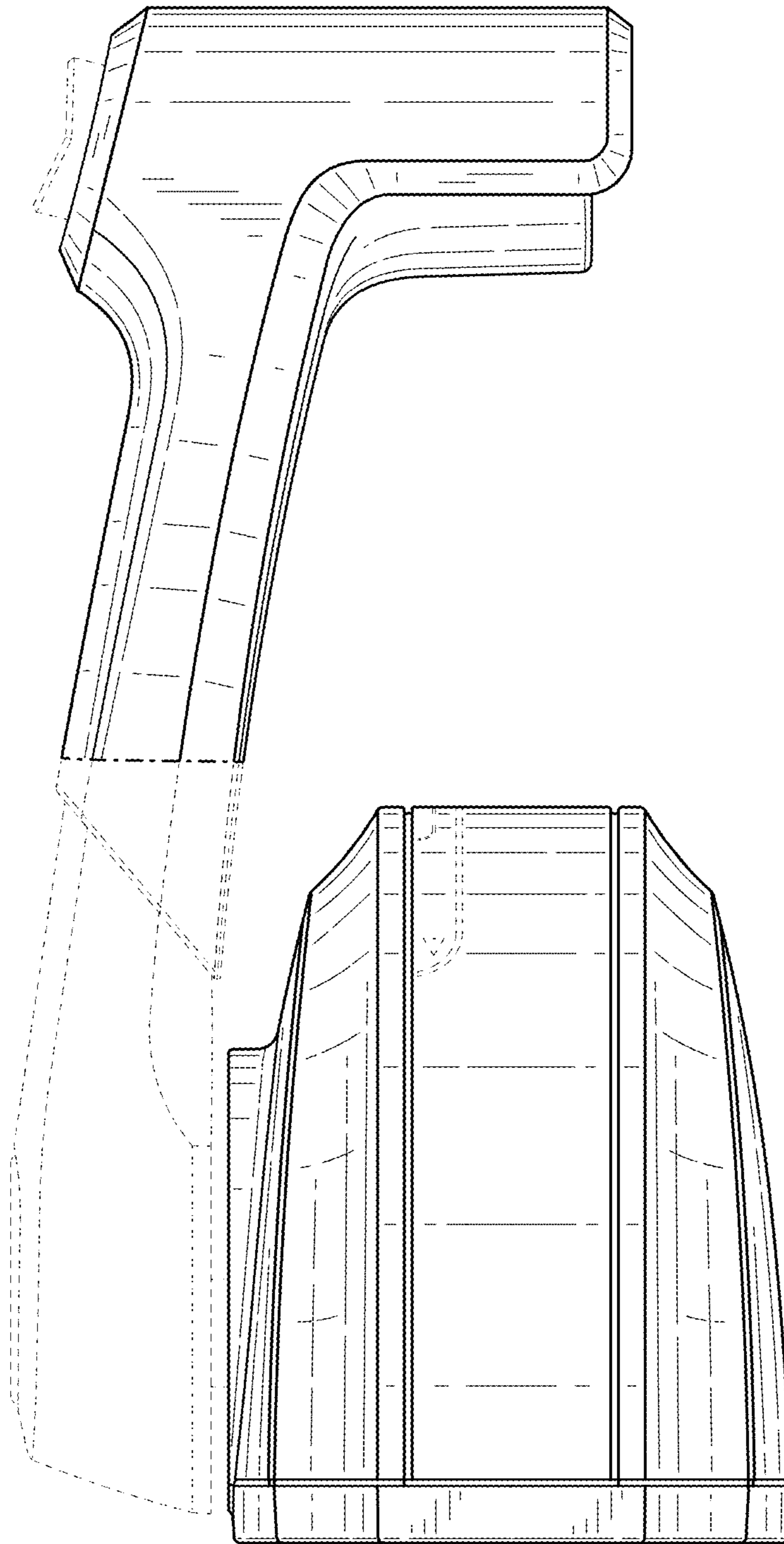

FIG. 4

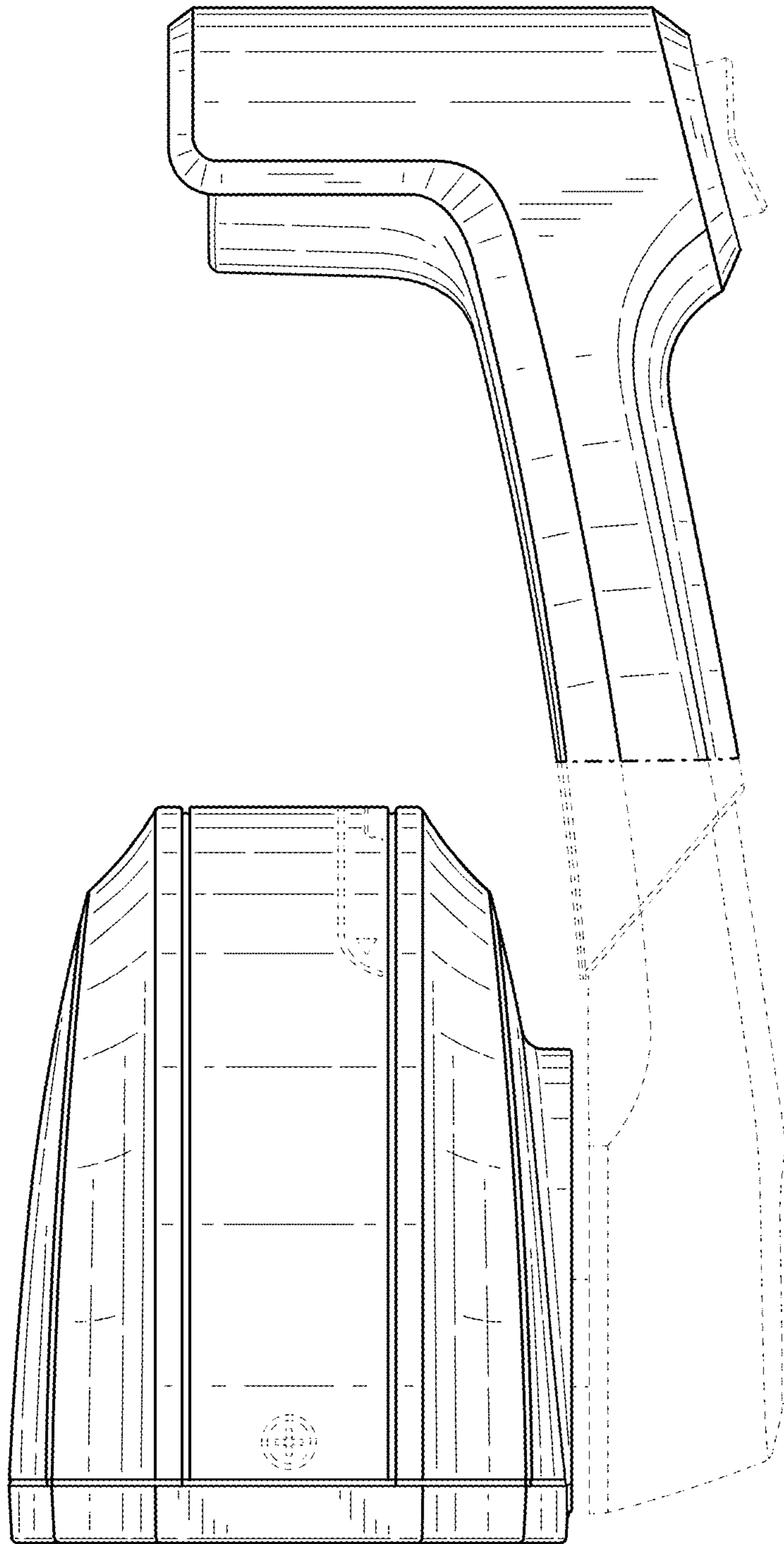

FIG. 5

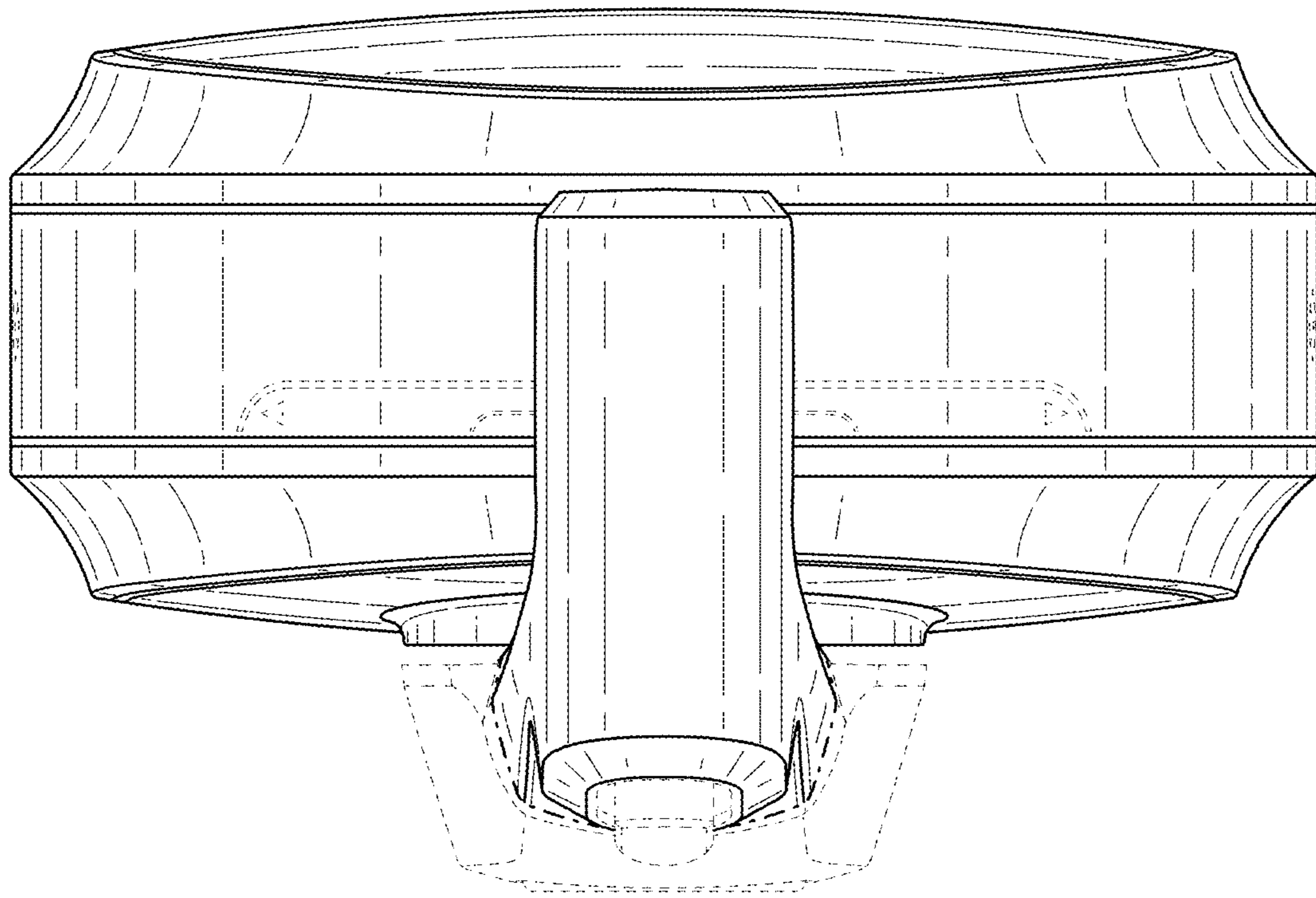

FIG. 6

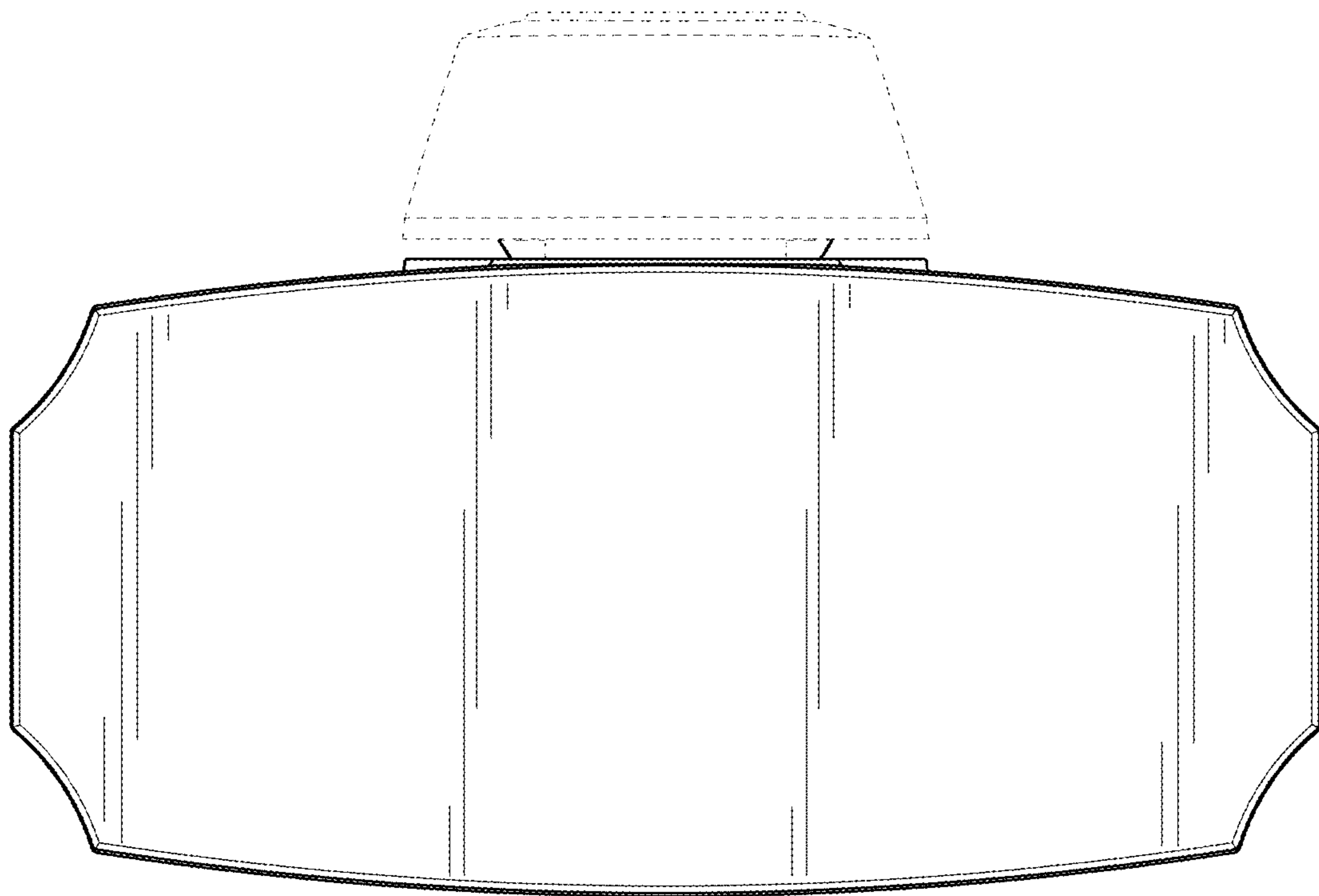

FIG. 7