



US00D988186S

(12) **United States Design Patent**  
**Xia**

(10) **Patent No.:** **US D988,186 S**  
(45) **Date of Patent:** **\*\* Jun. 6, 2023**

- (54) **FLAG POLE HOLDER**
- (71) Applicant: **Chenliang Xia**, Yongkang (CN)
- (72) Inventor: **Chenliang Xia**, Yongkang (CN)
- (\*\*) Term: **15 Years**
- (21) Appl. No.: **29/843,531**
- (22) Filed: **Jun. 22, 2022**
- (51) **LOC (14) Cl.** ..... **11-05**
- (52) **U.S. Cl.**  
USPC ..... **D11/182**
- (58) **Field of Classification Search**  
USPC .... D11/166, 181, 182, 183, 184; D8/37, 38,  
D8/72, 330, 339, 349, 351, 354, 363, 373,  
D8/376, 378, 380, 382, 383, 394, 396;  
D20/16, 17, 33, 41, 42, 43  
CPC ..... A47G 7/045; A45F 3/44; G09F 17/00;  
H01Q 1/1228  
See application file for complete search history.

- D476,919 S \* 7/2003 Vidmar ..... G09F 17/00  
D11/182
  - D477,245 S \* 7/2003 Luo ..... A01K 97/10  
D11/183
  - 6,726,170 B2\* 4/2004 Luo ..... G09F 17/00  
248/538
  - D639,206 S 6/2011 Lach et al.
  - D829,598 S \* 10/2018 Sanderson, Jr. .... D11/182
  - D829,599 S \* 10/2018 Sanderson, Jr. .... A01K 97/10  
D11/182
  - D856,188 S 8/2019 Caple
  - D921,747 S \* 6/2021 Tang ..... D8/373
- (Continued)

**OTHER PUBLICATIONS**

Haoridul holder, Dec. 9, 2020 found on Feb. 21, 2023 at [https://www.amazon.com/gp/product/B0963P4V3B/ref=ask\\_q1\\_qh\\_dp\\_hza](https://www.amazon.com/gp/product/B0963P4V3B/ref=ask_q1_qh_dp_hza) (Year: 2020).\*

(Continued)

*Primary Examiner* — Karen S Acker  
(74) *Attorney, Agent, or Firm* — Jeenam Park

(57) **CLAIM**

The ornamental design for a flag pole holder, as shown and described.

**DESCRIPTION**

FIG. 1 is a front and left perspective view of a flag pole holder, showing my new design;  
FIG. 2 is a front view thereof;  
FIG. 3 is a rear view thereof;  
FIG. 4 is a left side view thereof;  
FIG. 5 is a right side view thereof;  
FIG. 6 is a top plan view thereof; and,  
FIG. 7 is a bottom plan view thereof.  
FIG. 8 is a rear and right perspective view thereof.  
The broken lines and areas within them depict portions of the flag pole holder that form no part of the claimed design.

**1 Claim, 8 Drawing Sheets**

- (56) **References Cited**  
U.S. PATENT DOCUMENTS
- D32,333 S \* 3/1900 Hart ..... G09F 17/00  
D11/182
- D46,417 S \* 9/1914 Tice ..... D11/182
- 1,761,497 A \* 6/1930 Smith ..... A01K 97/10  
248/539
- 2,719,659 A \* 10/1955 Bowman ..... A01K 97/10  
235/1 R
- 3,920,207 A \* 11/1975 Adamaitis ..... A01K 97/10  
224/907
- D251,045 S \* 2/1979 Grube ..... D8/355
- 5,269,488 A \* 12/1993 Lach ..... F16M 13/02  
248/512
- RE35,731 E \* 2/1998 Lach ..... G09F 17/00  
248/512
- D425,394 S \* 5/2000 Brady ..... D8/330
- D448,717 S \* 10/2001 Hanson ..... D12/162

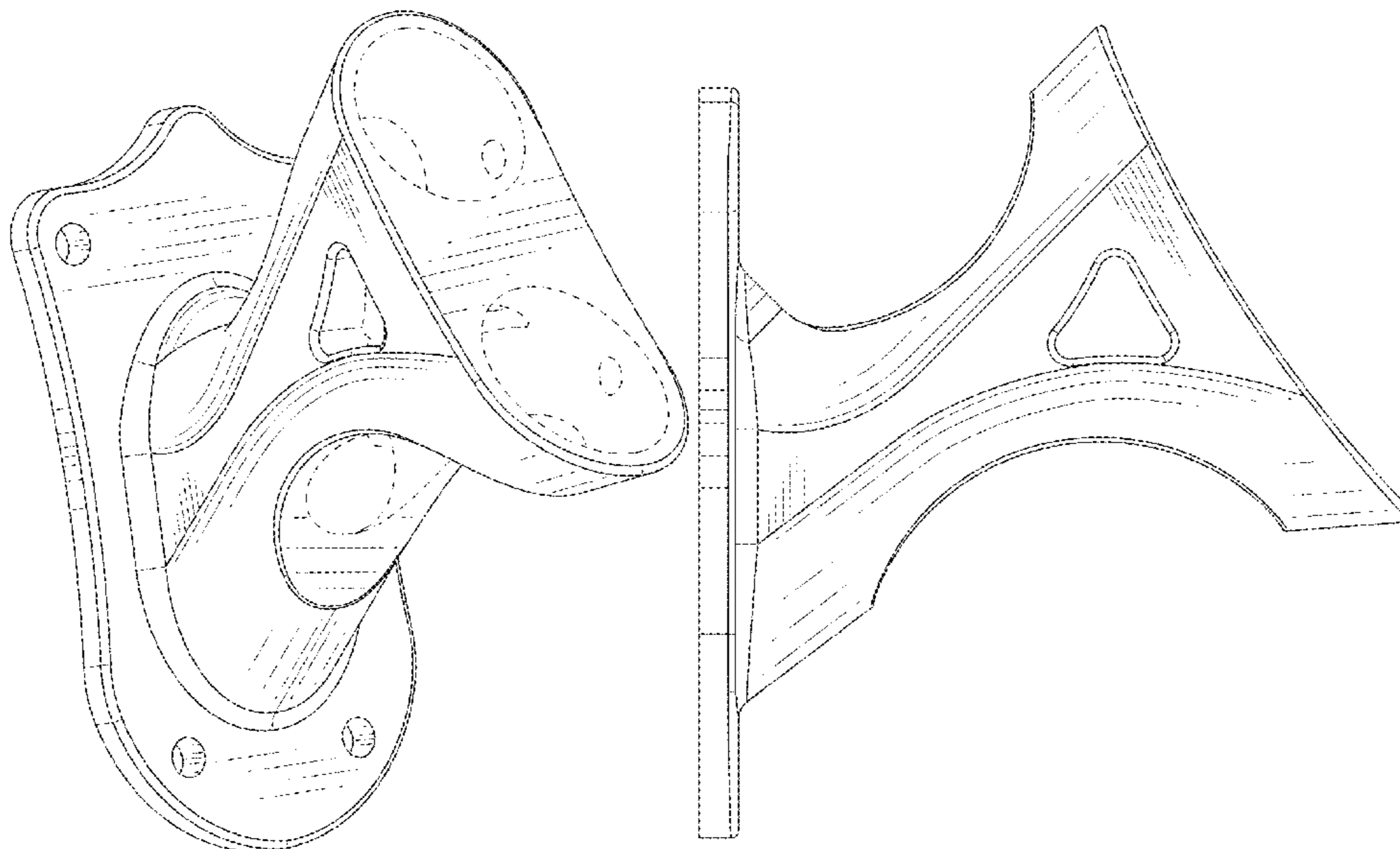

(56)

**References Cited**

U.S. PATENT DOCUMENTS

D936,515 S \* 11/2021 Hu ..... D11/182  
2003/0168573 A1 \* 9/2003 Luo ..... G09F 17/00  
248/512

OTHER PUBLICATIONS

Waenlir holder, Jan. 12, 2022 found on Feb. 21, 2023 at [https://www.amazon.com/WAENLIR-Position-Stainless-Mounting-Diameter/dp/B091P414NZ/ref=cm\\_cr\\_arp\\_d\\_product\\_top?ie=UTF8](https://www.amazon.com/WAENLIR-Position-Stainless-Mounting-Diameter/dp/B091P414NZ/ref=cm_cr_arp_d_product_top?ie=UTF8) (Year: 2022).\*

Geek Cheers. Nov. 26, 2019, found on Feb. 21, 2023 at [https://www.amazon.com/dp/B07SKX576S/ref=sspa\\_dk\\_detail\\_3?pd\\_rd\\_i=B07SKX576S&pd\\_rd\\_w=qxZ28&content-id=amzn1.sym.af9528d2-09ba-47ee-b909-59e3022bebe1&pf\\_rd\\_p=af9528d2-](https://www.amazon.com/dp/B07SKX576S/ref=sspa_dk_detail_3?pd_rd_i=B07SKX576S&pd_rd_w=qxZ28&content-id=amzn1.sym.af9528d2-09ba-47ee-b909-59e3022bebe1&pf_rd_p=af9528d2-) (Year: 2019).\*

Unco, Jun. 2, 2022, found on Feb. 2023 at [https://www.amazon.com/Aluminum-Holder-Bracket-Mounting-Brackets/dp/B0B14W6YGQ/ref=cm\\_cr\\_arp\\_d\\_product\\_top?ie=UTF8](https://www.amazon.com/Aluminum-Holder-Bracket-Mounting-Brackets/dp/B0B14W6YGQ/ref=cm_cr_arp_d_product_top?ie=UTF8) (Year: 2022).\*

\* cited by examiner

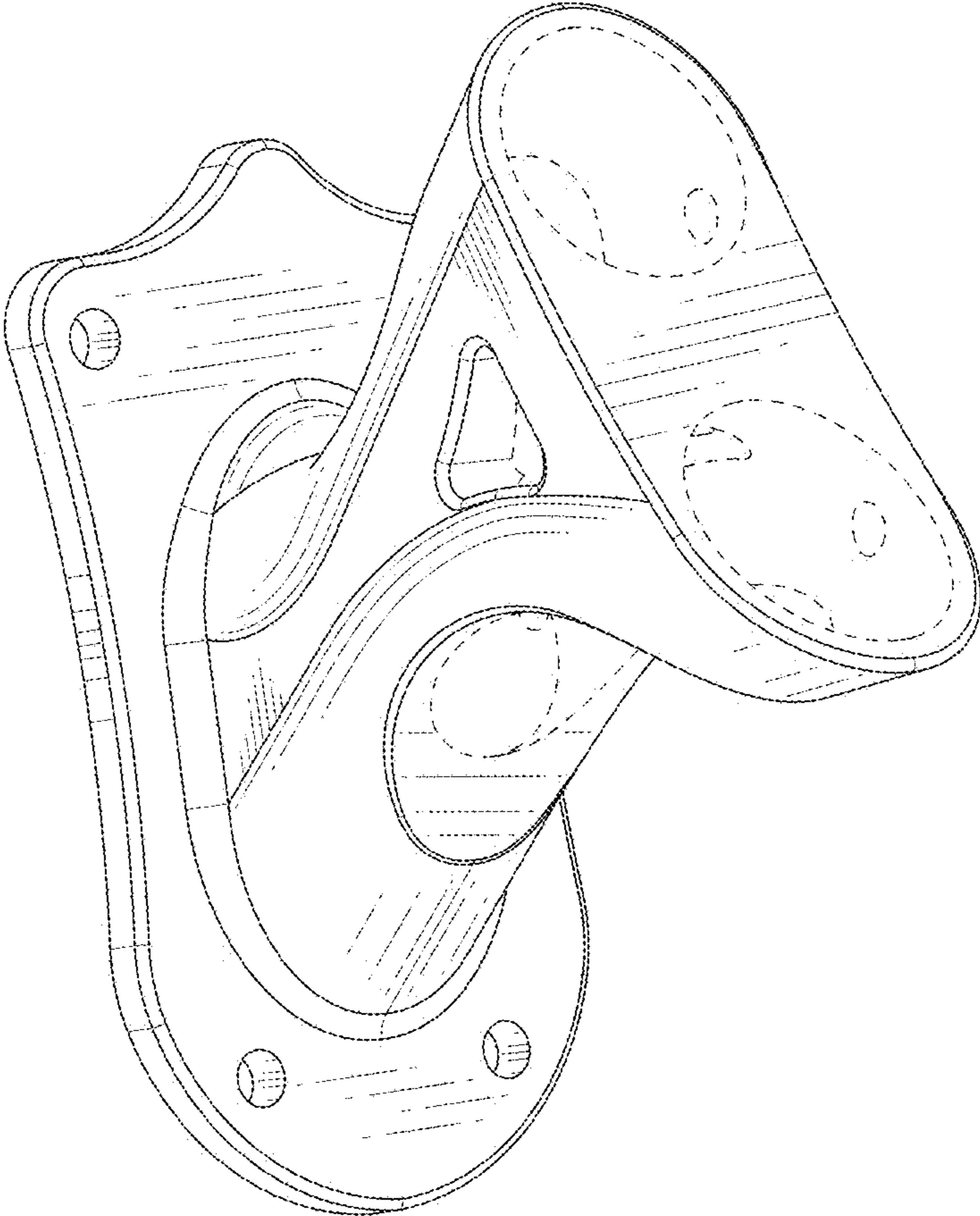

FIG. 1

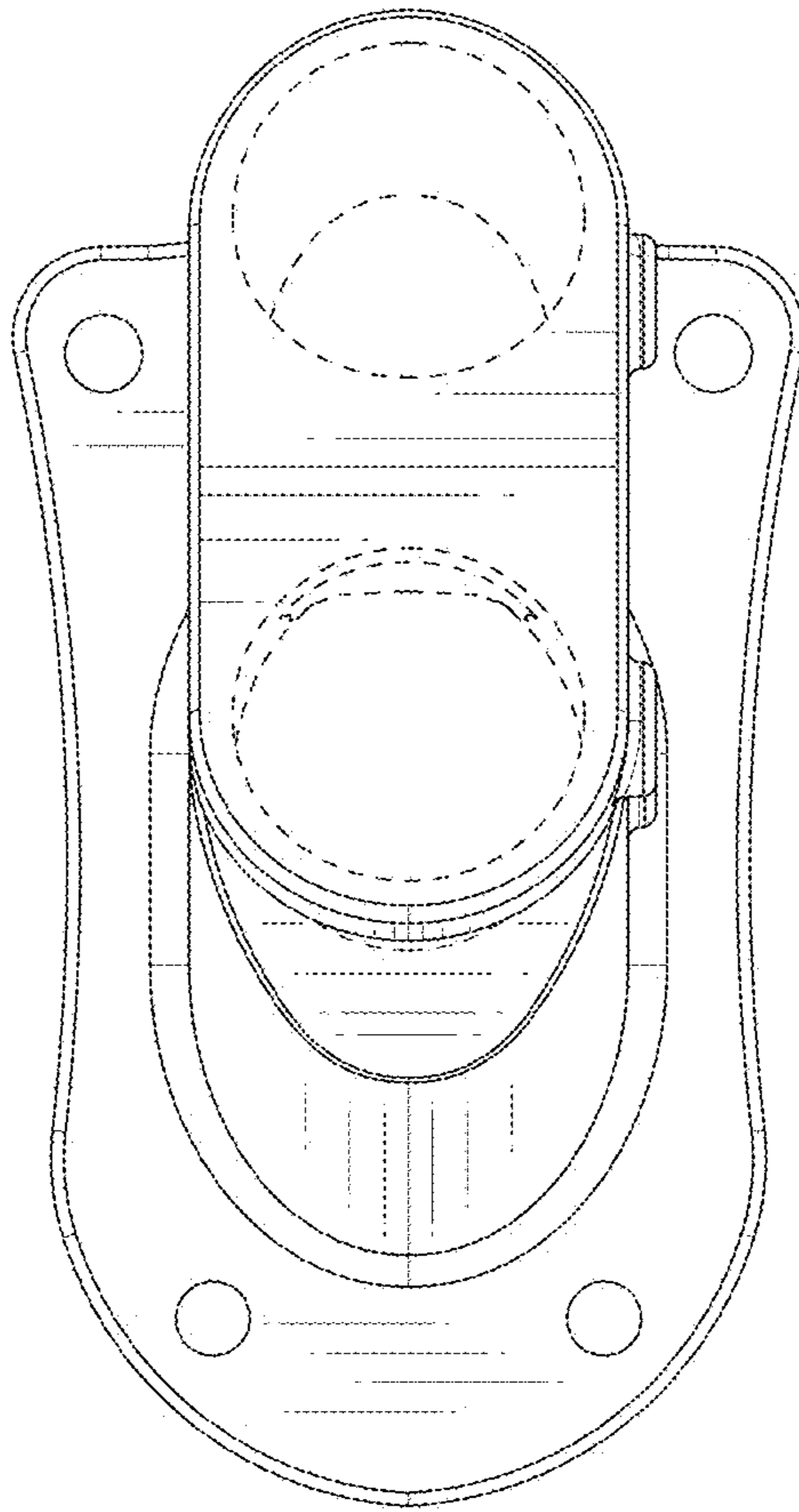

FIG. 2

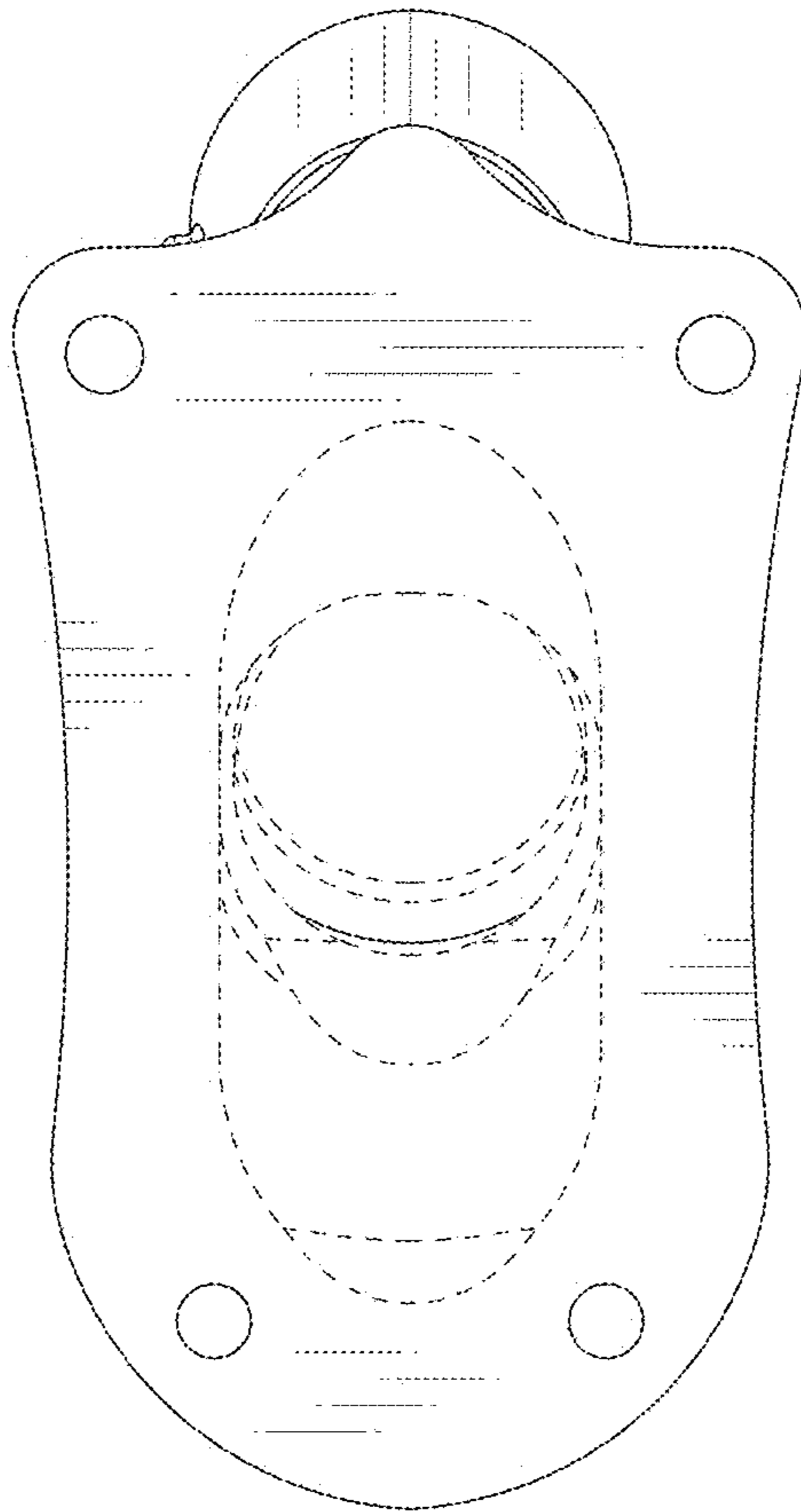

FIG. 3

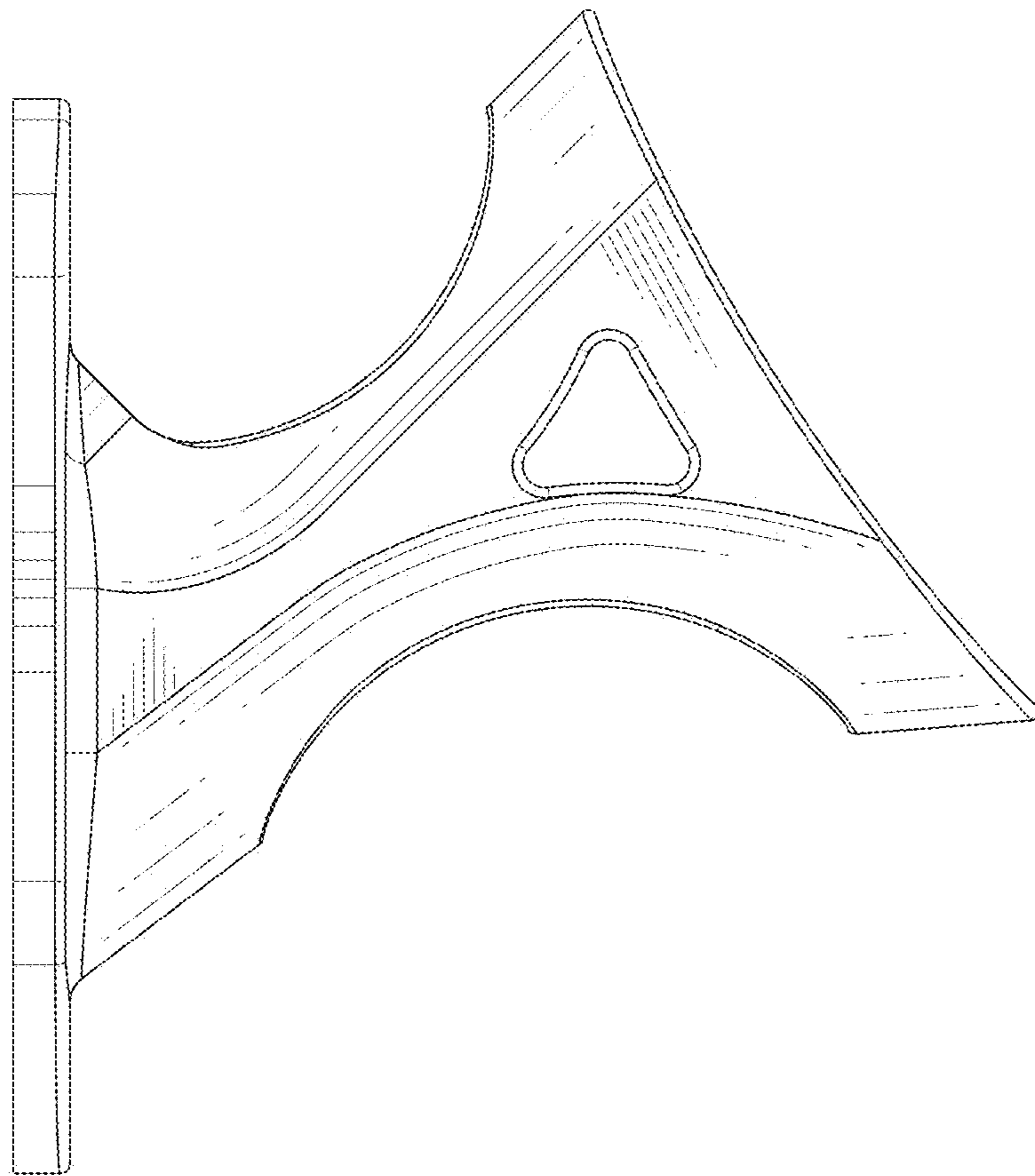

FIG. 4

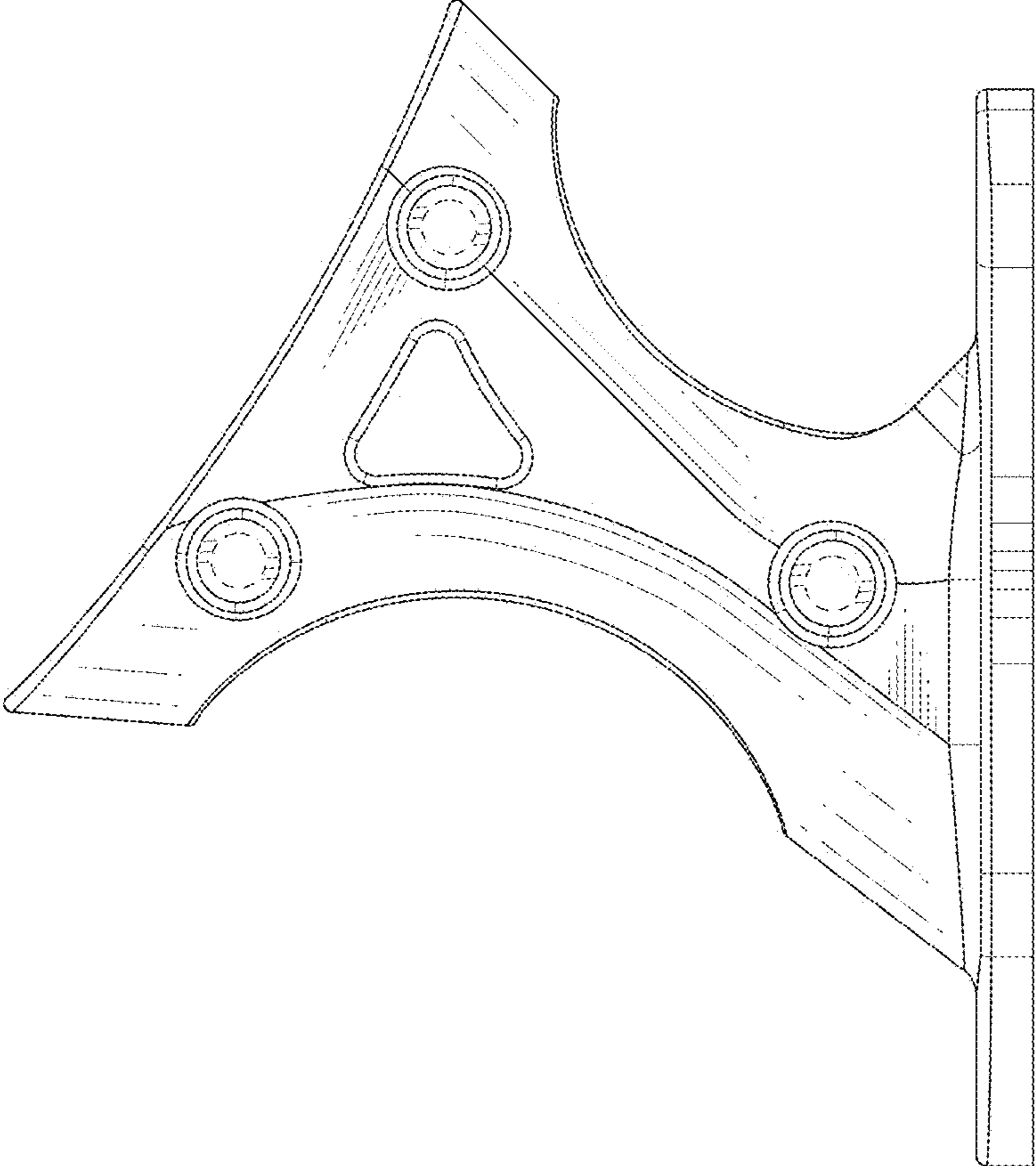

FIG. 5

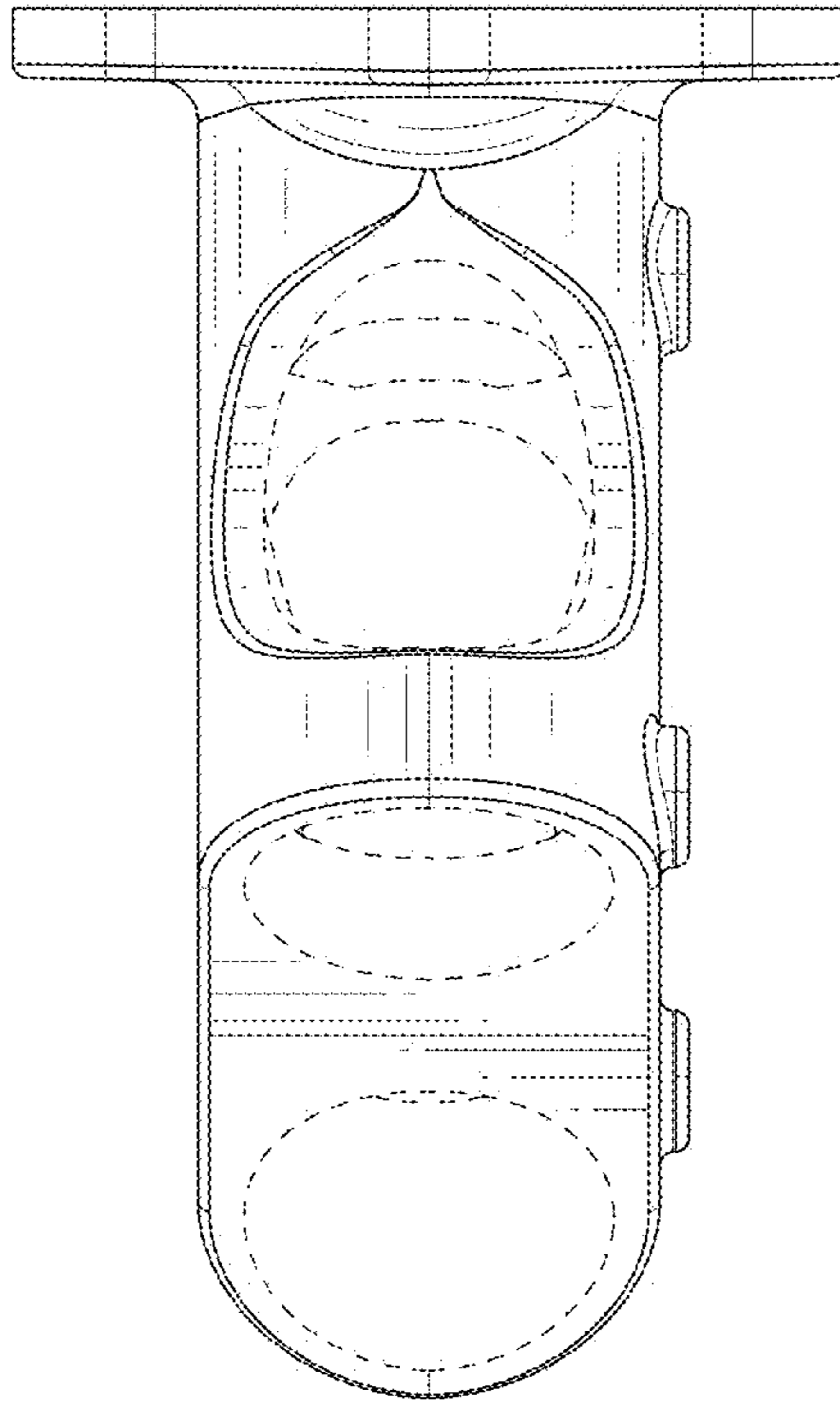

FIG. 6



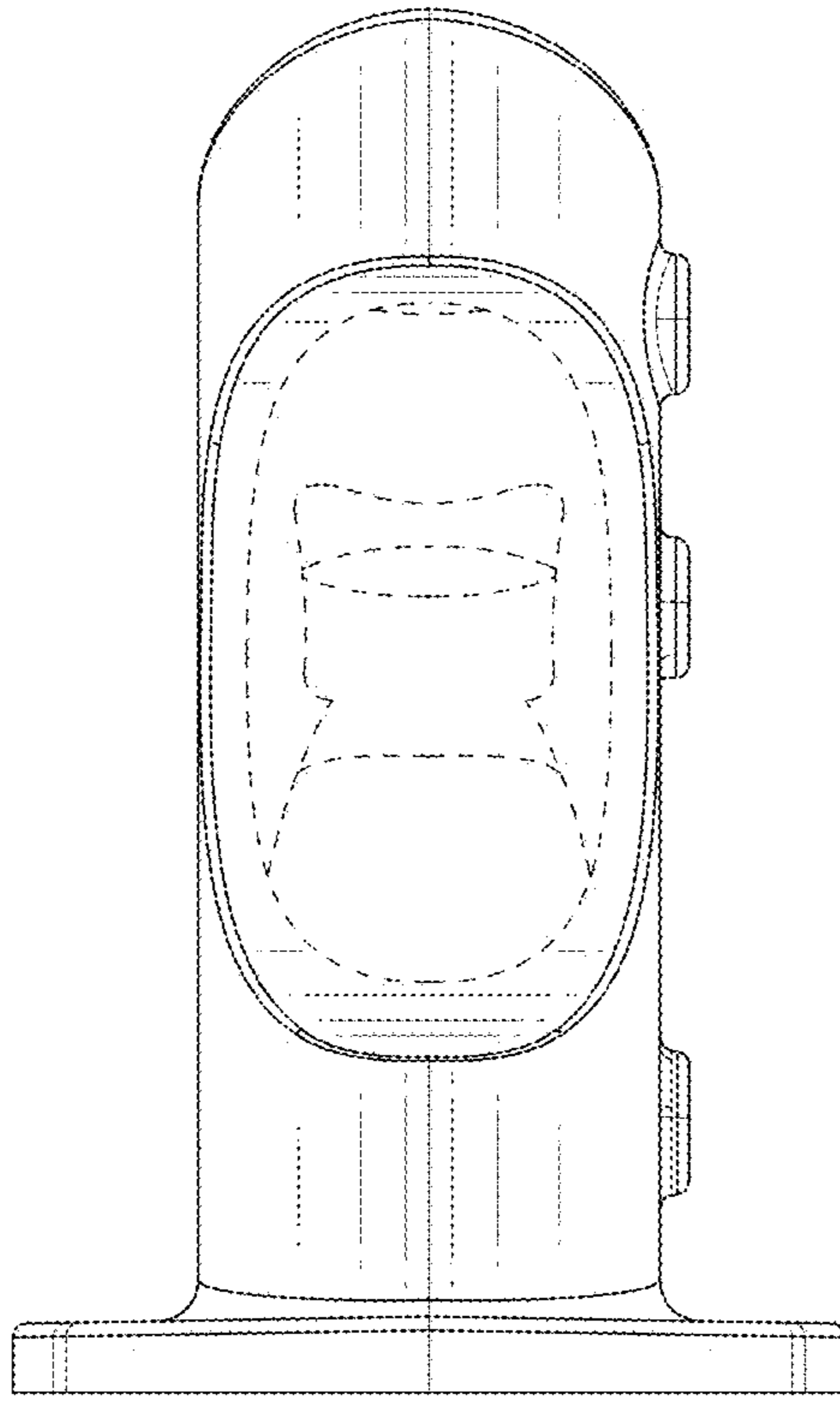

FIG. 7

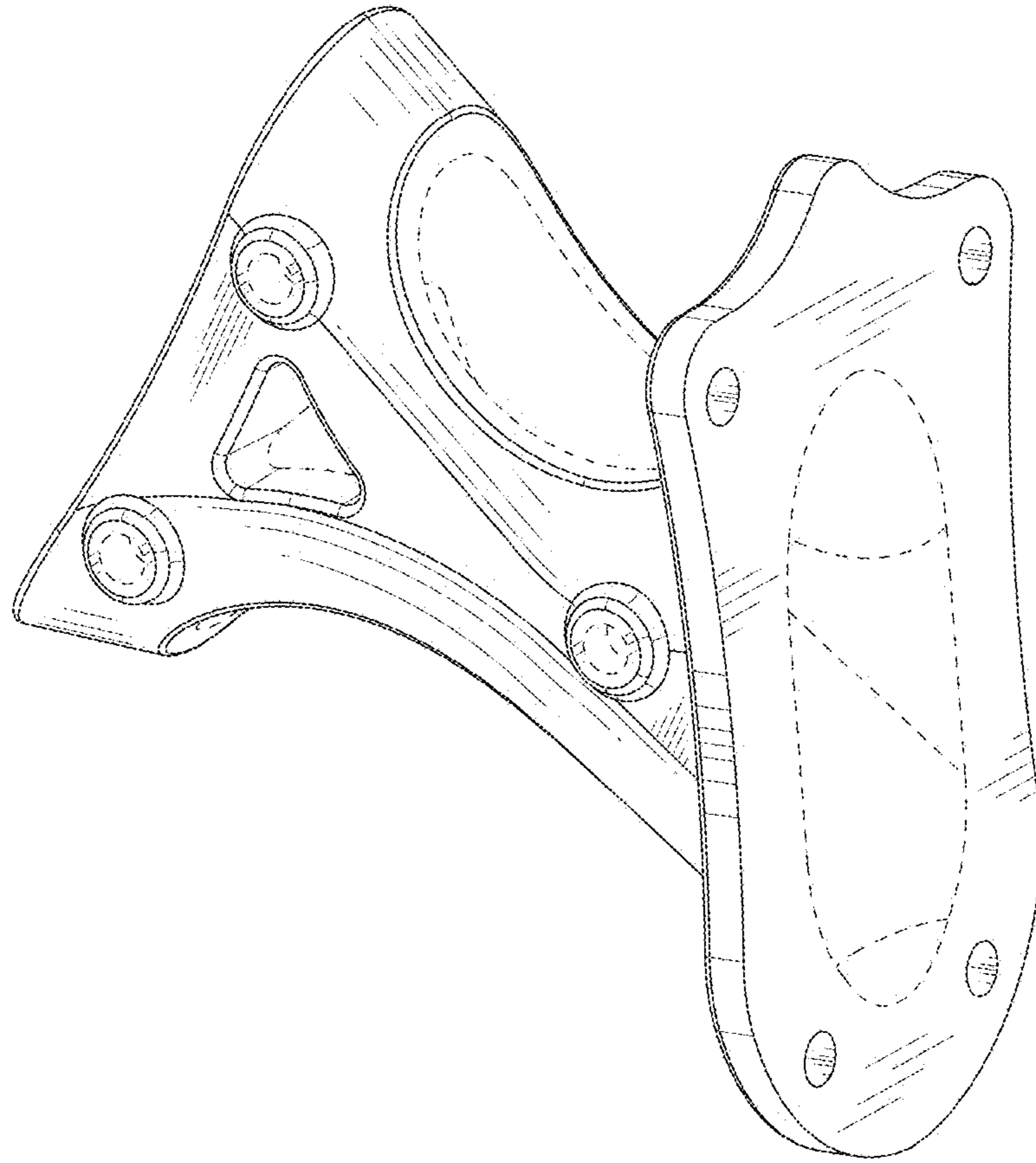

FIG. 8