



US00D988041S

(12) **United States Design Patent**
Zhang

(10) **Patent No.:** **US D988,041 S**

(45) **Date of Patent:** **** Jun. 6, 2023**

(54) **HANGING BASKET**

(71) Applicant: **Xiaodan Zhang**, Sangzhi (CN)

(72) Inventor: **Xiaodan Zhang**, Sangzhi (CN)

(**) Term: **15 Years**

(21) Appl. No.: **29/881,511**

(22) Filed: **Jan. 3, 2023**

(30) **Foreign Application Priority Data**

Sep. 1, 2022 (CN) 202230576129.2
Sep. 1, 2022 (CN) 202230576210.0

(51) **LOC (14) Cl.** **06-06**

(52) **U.S. Cl.**
USPC **D6/675.1**

(58) **Field of Classification Search**
USPC D6/512-513, 524, 553, 566-567, 569,
D6/672, 675, 675.1, 675.2; D7/600.1,
D7/600.4
CPC A47B 96/16; A47B 57/00; A47B 96/06;
A47F 5/00; A47F 5/01; A47F 5/08; A47F
5/0006; A47F 5/0807
See application file for complete search history.

(56) **References Cited**

U.S. PATENT DOCUMENTS

D267,692 S * 1/1983 Kates D6/675.1
D285,156 S * 8/1986 Chap D6/570
D463,697 S * 10/2002 Klein D6/514
D576,073 S 9/2008 Paniccia
D616,680 S * 6/2010 Snider D6/513
D671,441 S 11/2012 Luna
D707,588 S 6/2014 Pettigrew et al.
D862,949 S * 10/2019 Ghiorghie D6/675.2
D873,081 S * 1/2020 Goodman D7/600.1

D904,127 S * 12/2020 Song D7/600.1
D915,148 S * 4/2021 Li D7/600.4
D923,422 S * 6/2021 Xu D7/600.4
D924,635 S * 7/2021 Tsai D7/600.4

(Continued)

Primary Examiner — Kelley A Donnelly

(74) *Attorney, Agent, or Firm* — Rumit Ranjit Kanakia

(57) **CLAIM**

The ornamental design for a hanging basket, as shown and described.

DESCRIPTION

FIG. 1 is a first perspective view of a first embodiment of a hanging basket showing my new design;

FIG. 2 is a second perspective view of the first embodiment thereof;

FIG. 3 is a front view of the first embodiment thereof;

FIG. 4 is a back view of the first embodiment thereof;

FIG. 5 is a left side view of the first embodiment thereof;

FIG. 6 is a right side view of the first embodiment thereof;

FIG. 7 is a top view of the first embodiment thereof;

FIG. 8 is a bottom view of the first embodiment thereof;

FIG. 9 is a first perspective view of a second embodiment of a hanging basket showing my new design;

FIG. 10 is a second perspective view of the second embodiment thereof;

FIG. 11 is a front view of the second embodiment thereof;

FIG. 12 is a back view of the second embodiment thereof;

FIG. 13 is a left side view of the second embodiment thereof;

FIG. 14 is a right side view of the second embodiment thereof;

FIG. 15 is a top view of the second embodiment thereof;

FIG. 16 is a bottom view of the second embodiment thereof; and,

FIG. 17 is an enlarged view of the selected portion 17 in FIG. 9.

1 Claim, 17 Drawing Sheets

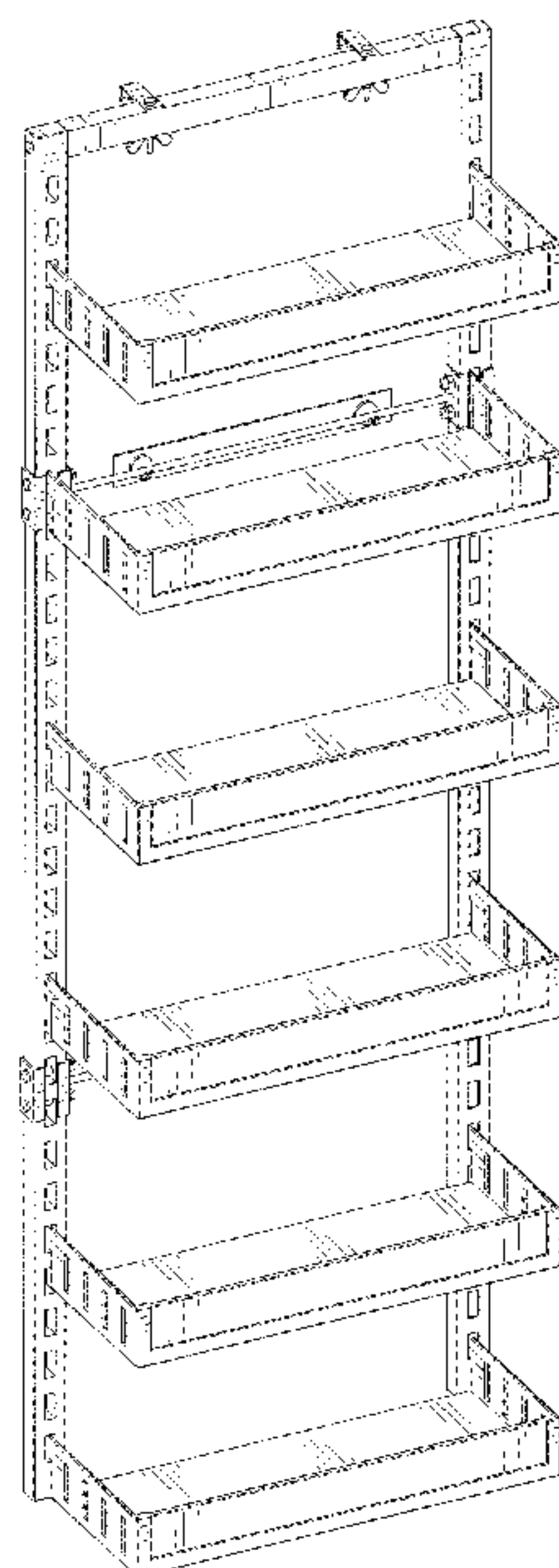

(56)

References Cited

U.S. PATENT DOCUMENTS

D942,177 S * 2/2022 Liu D6/569
D942,772 S * 2/2022 Liu D6/569
D968,136 S * 11/2022 Peng D6/675.1
D968,845 S * 11/2022 Gao D6/569

* cited by examiner

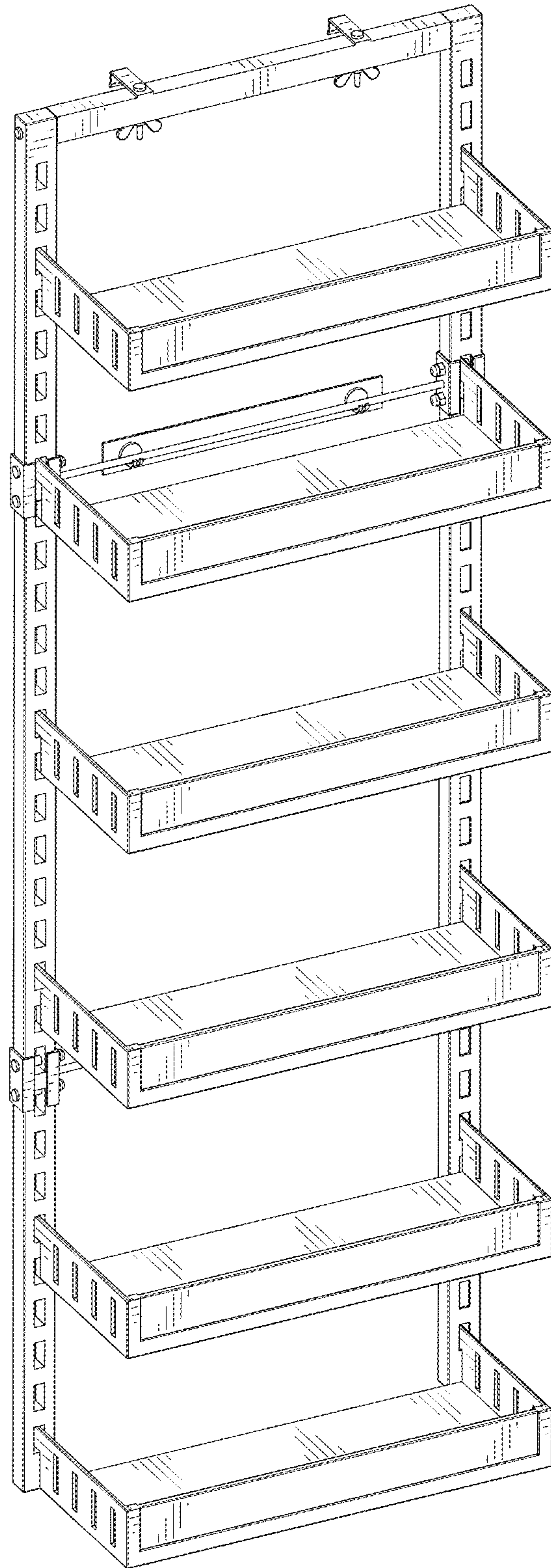

FIG. 1

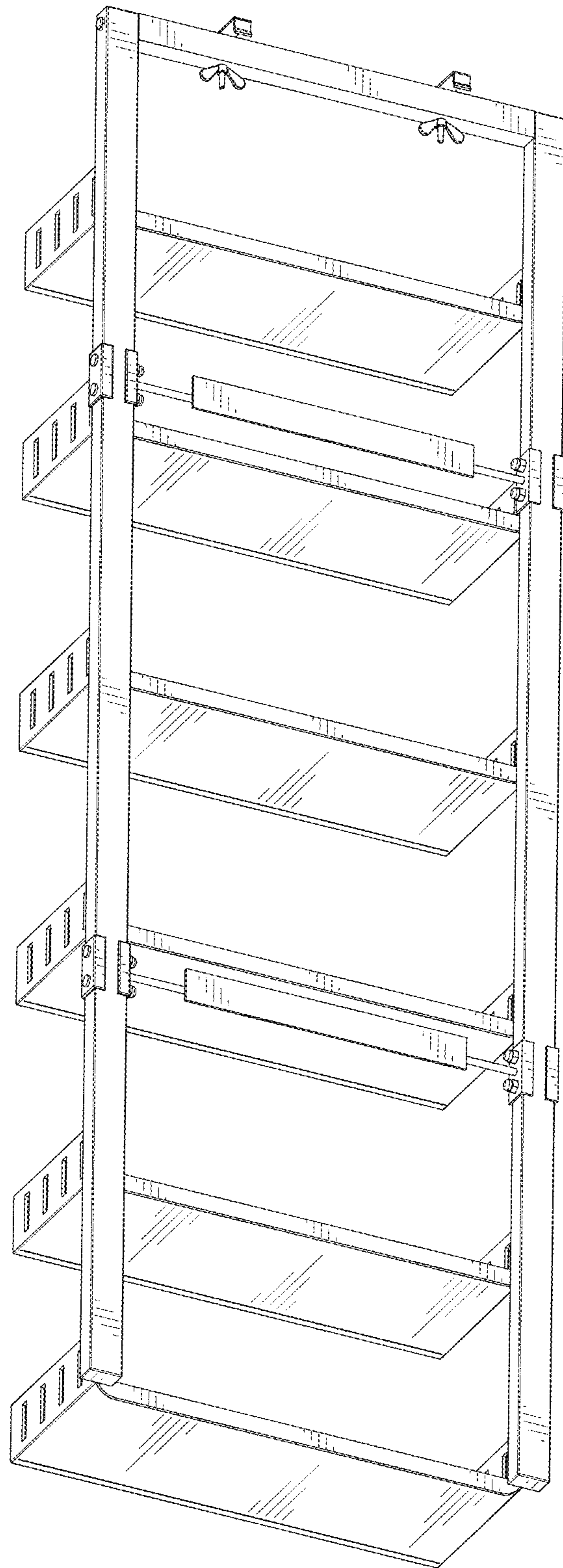

FIG. 2

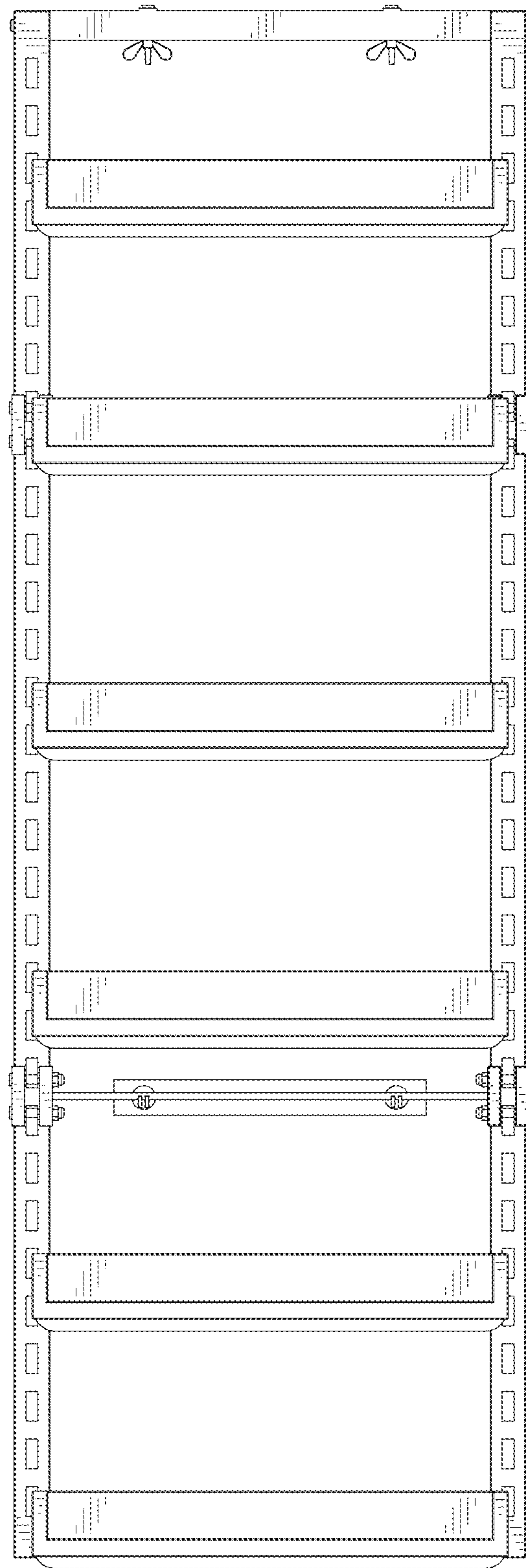

FIG. 3

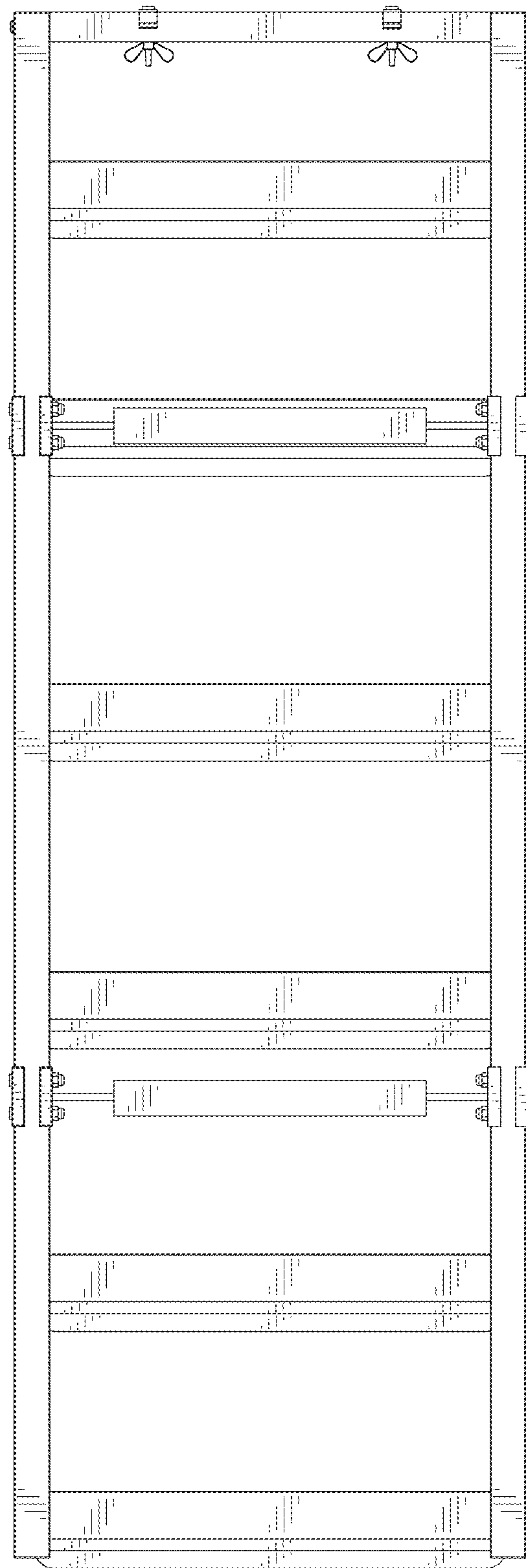

FIG. 4

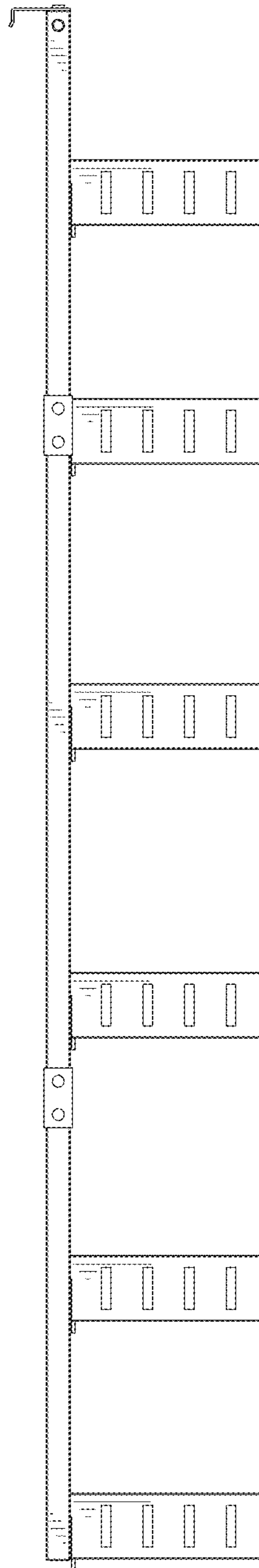

FIG. 5

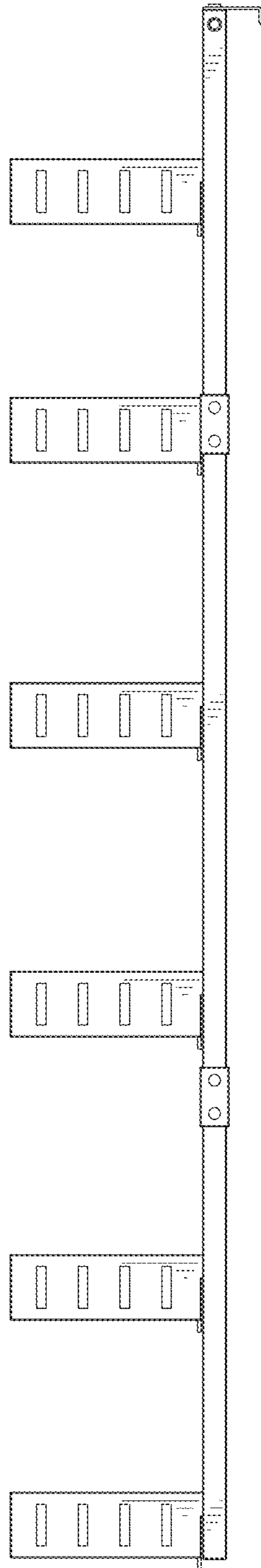

FIG. 6

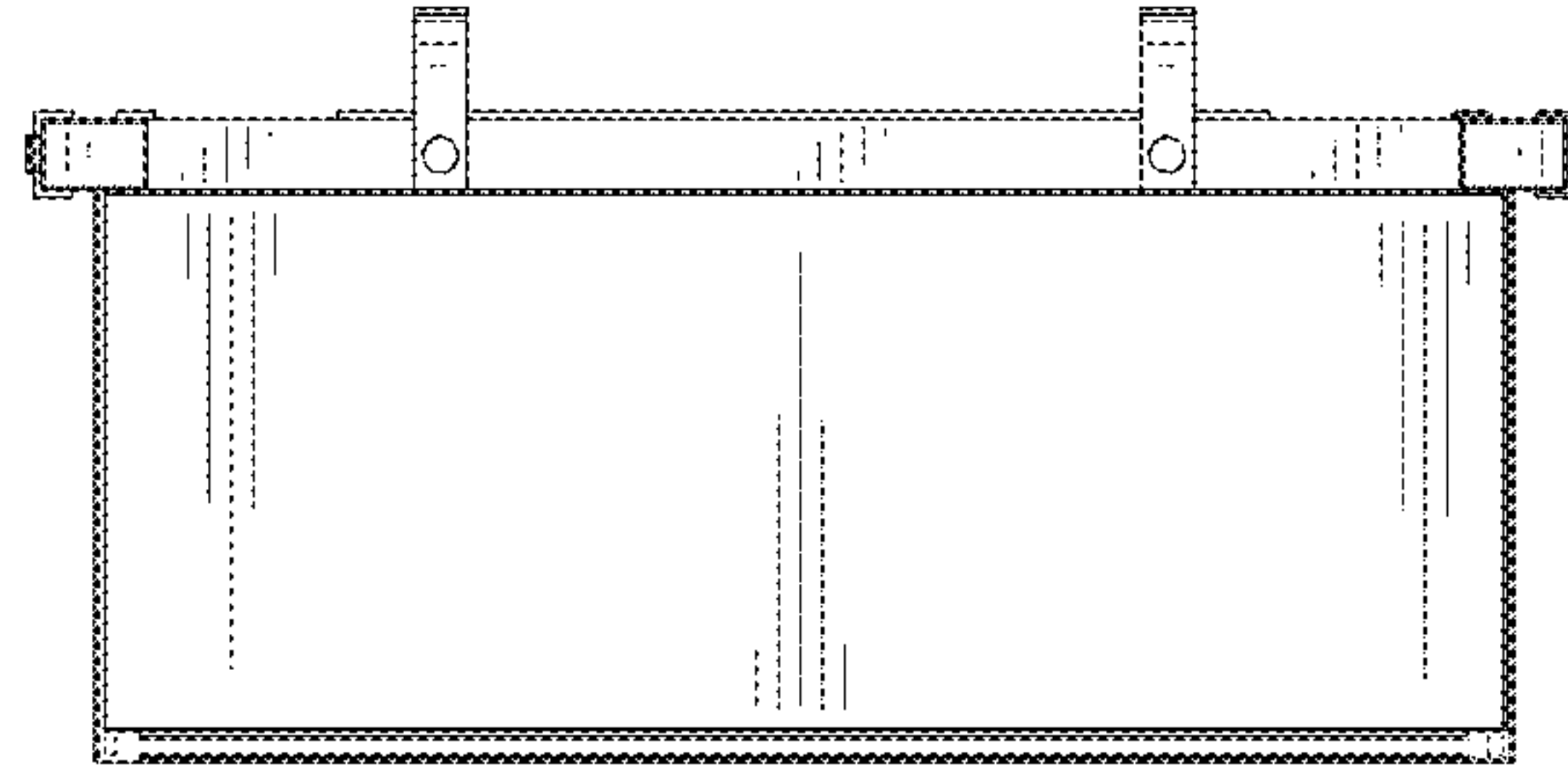

FIG. 7

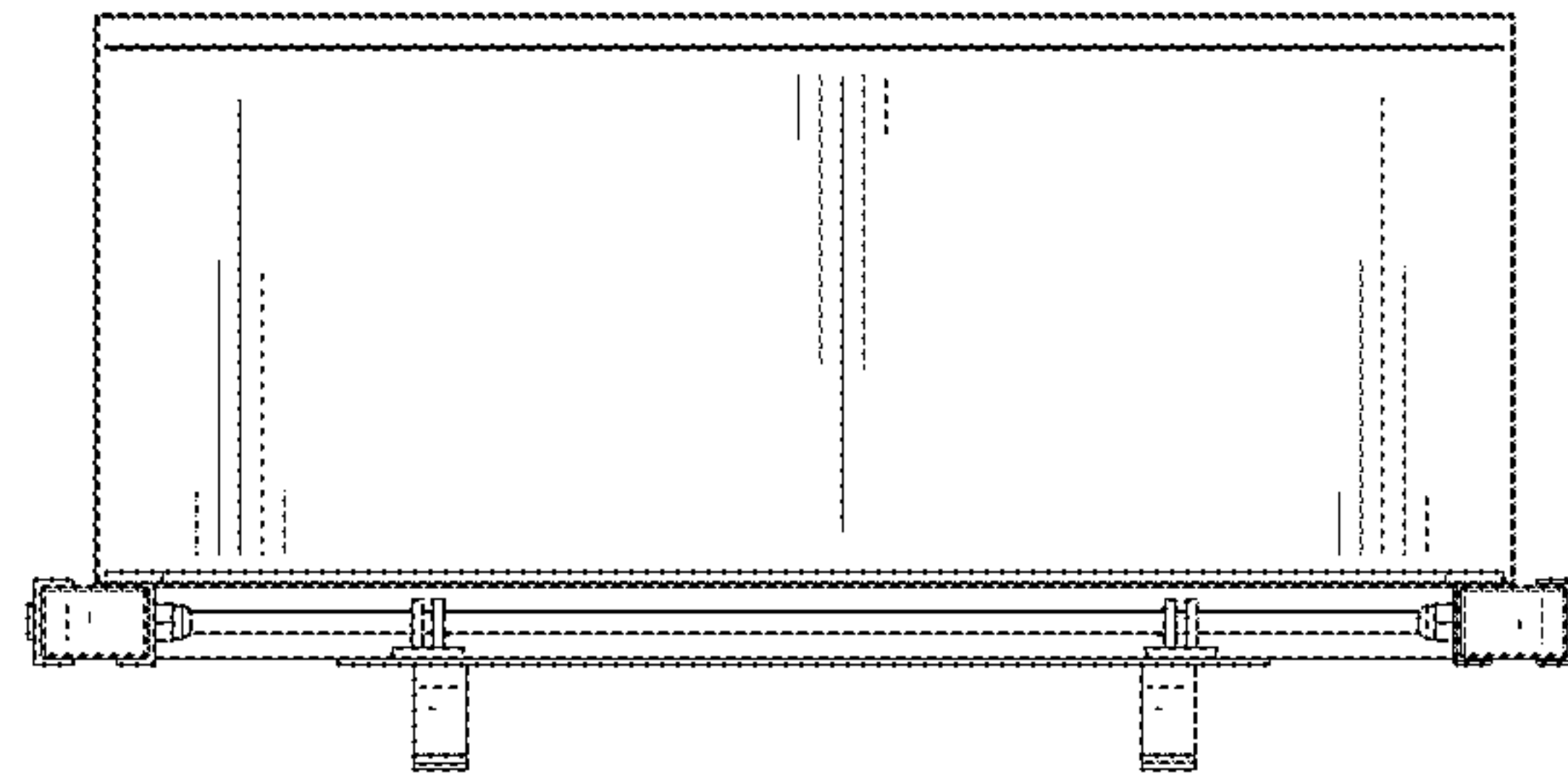

FIG. 8

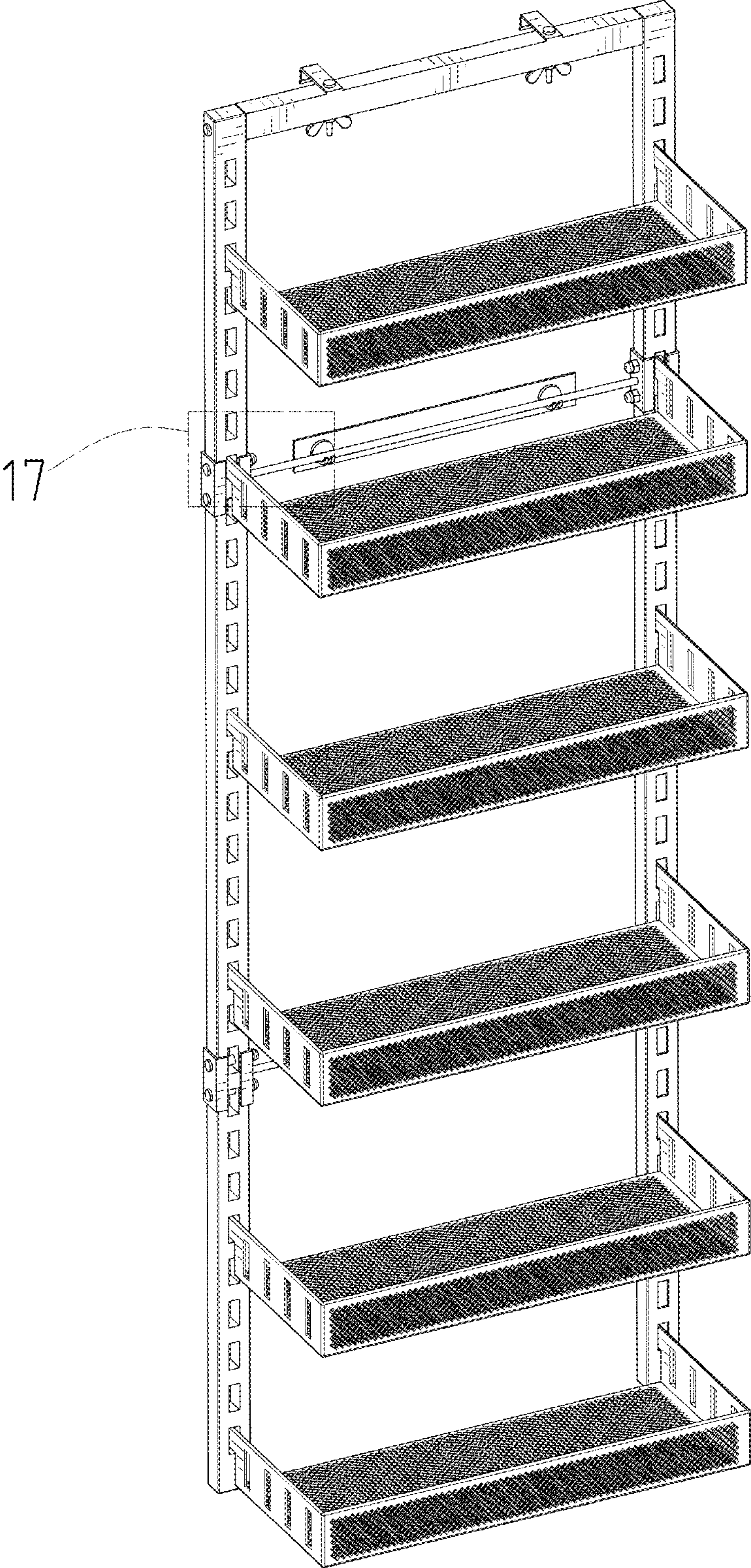

FIG. 9

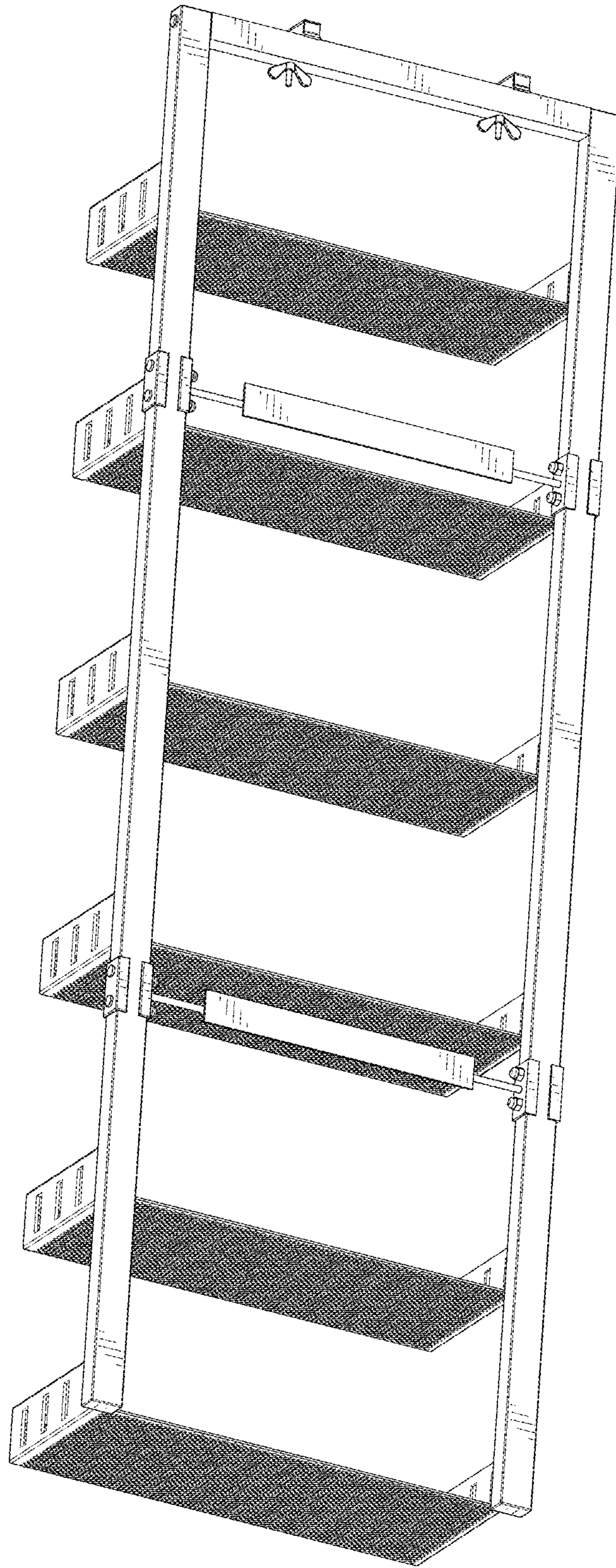

FIG. 10

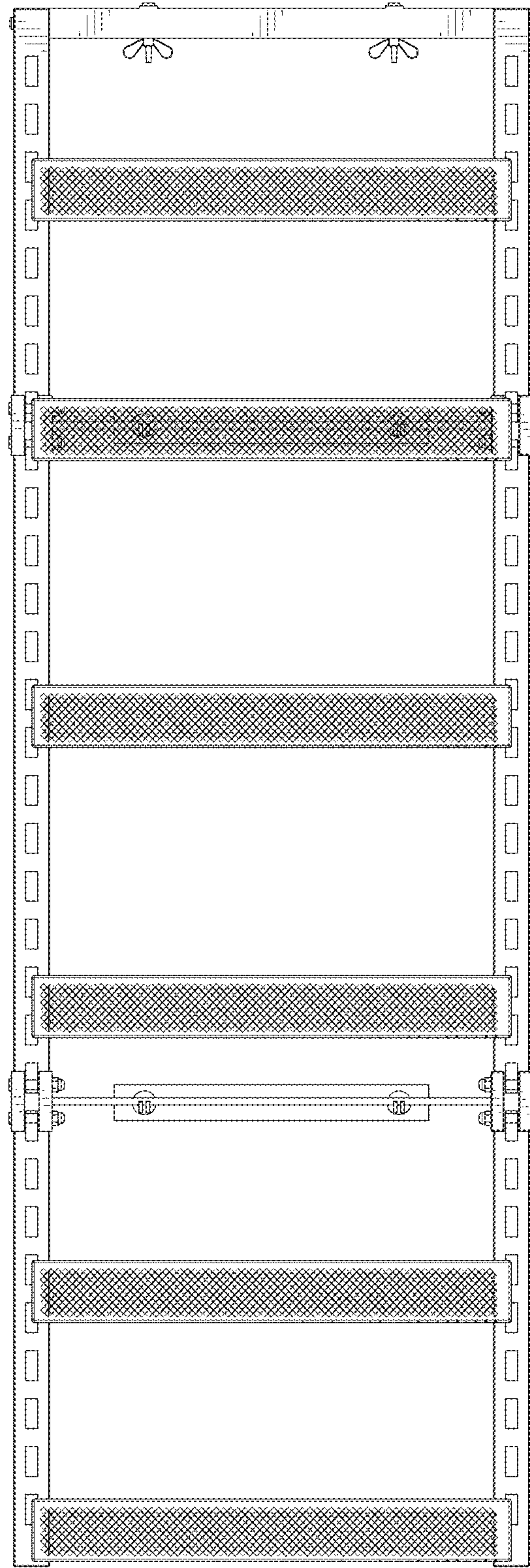

FIG. 11

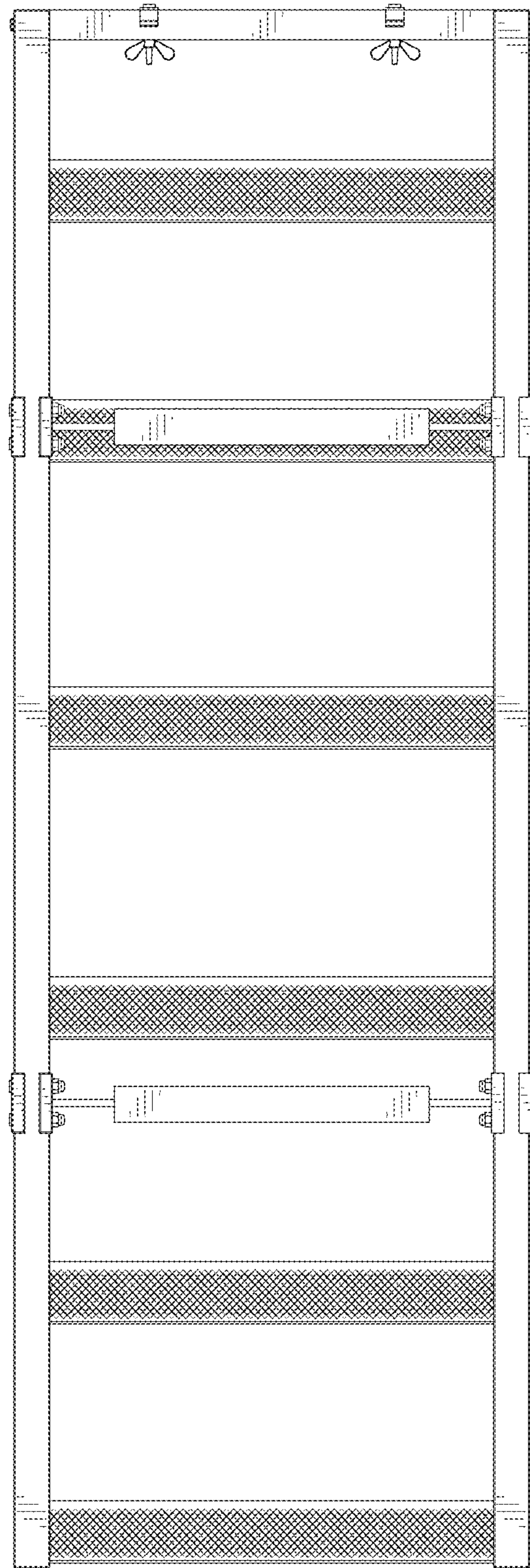

FIG. 12

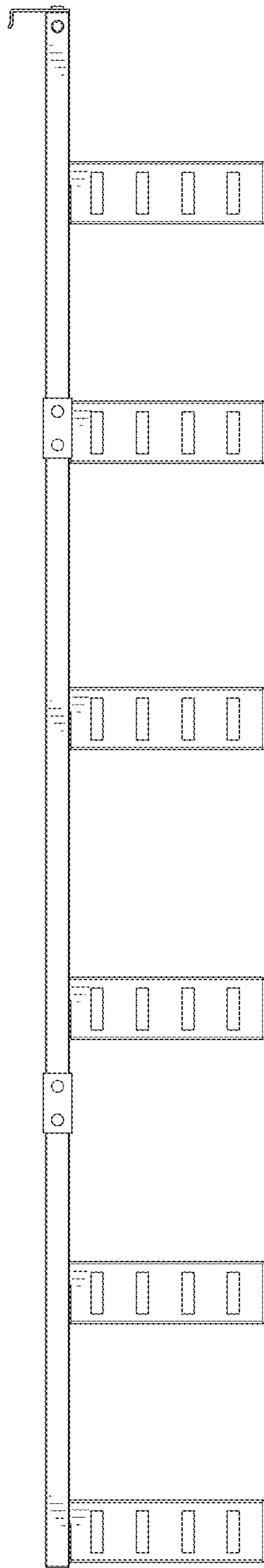

FIG. 13

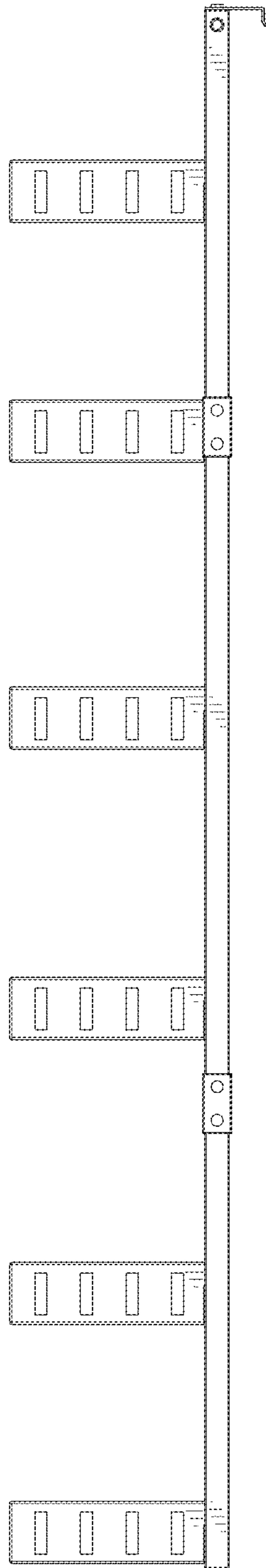

FIG. 14

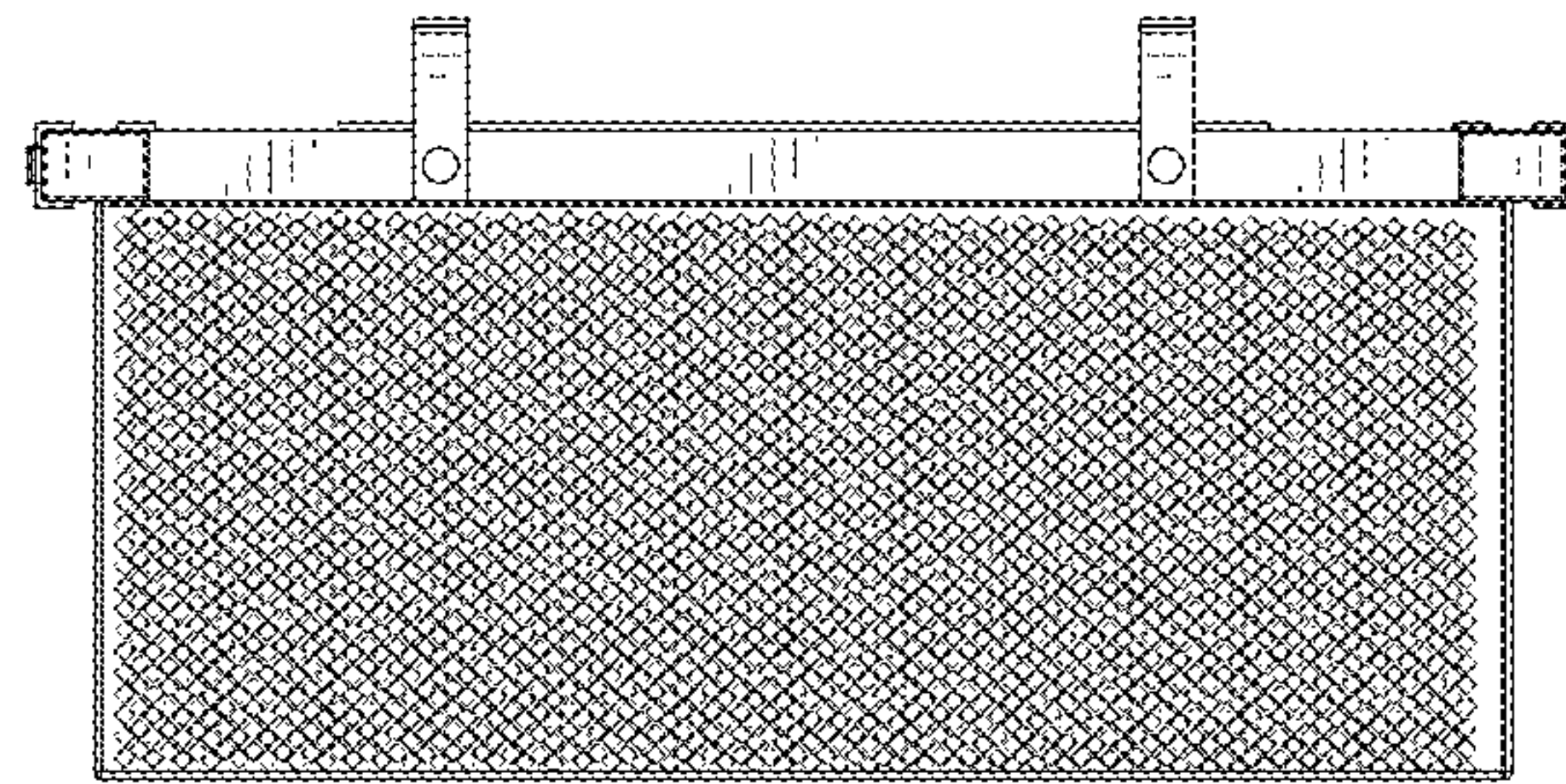

FIG. 15

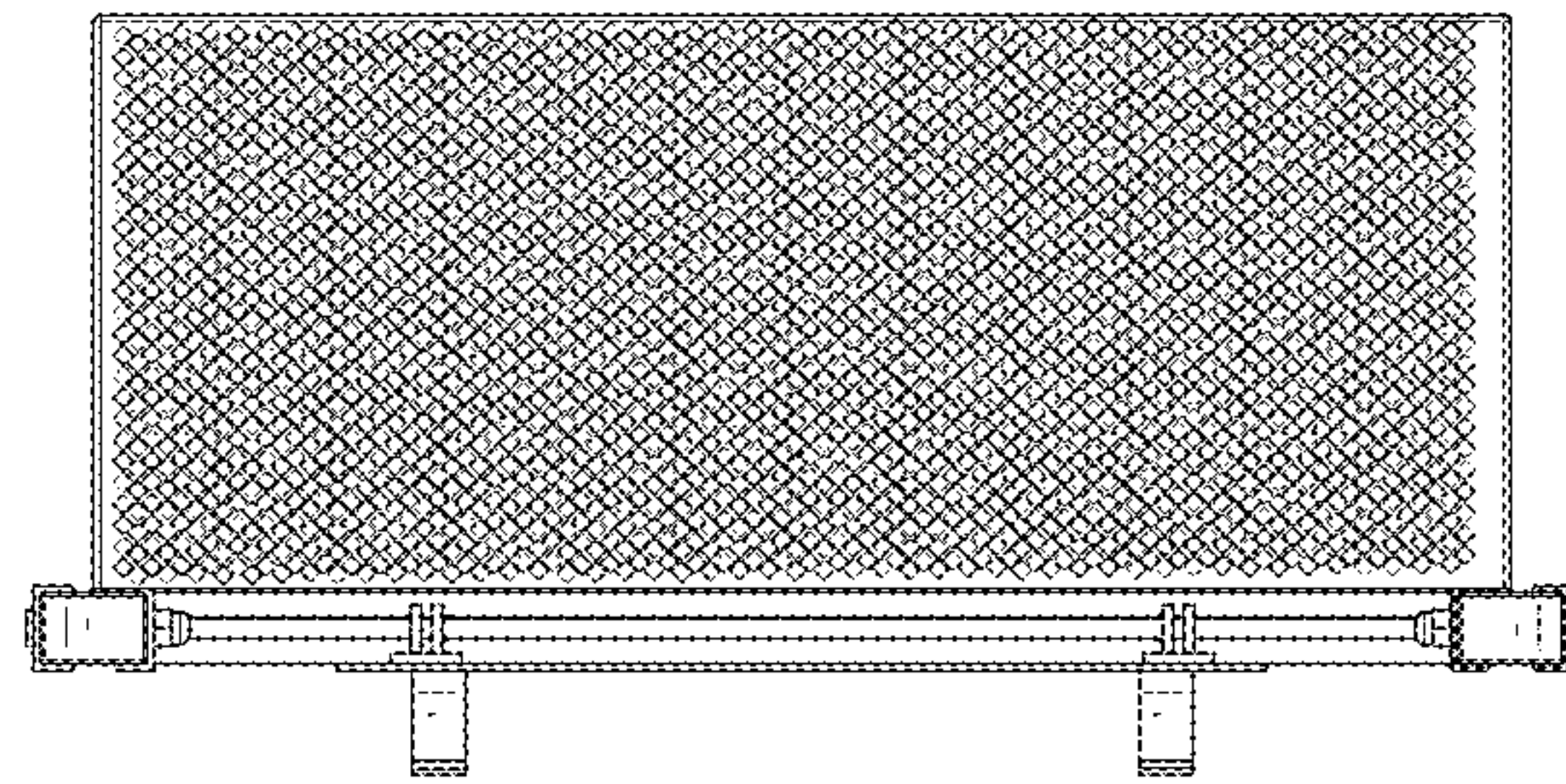

FIG. 16

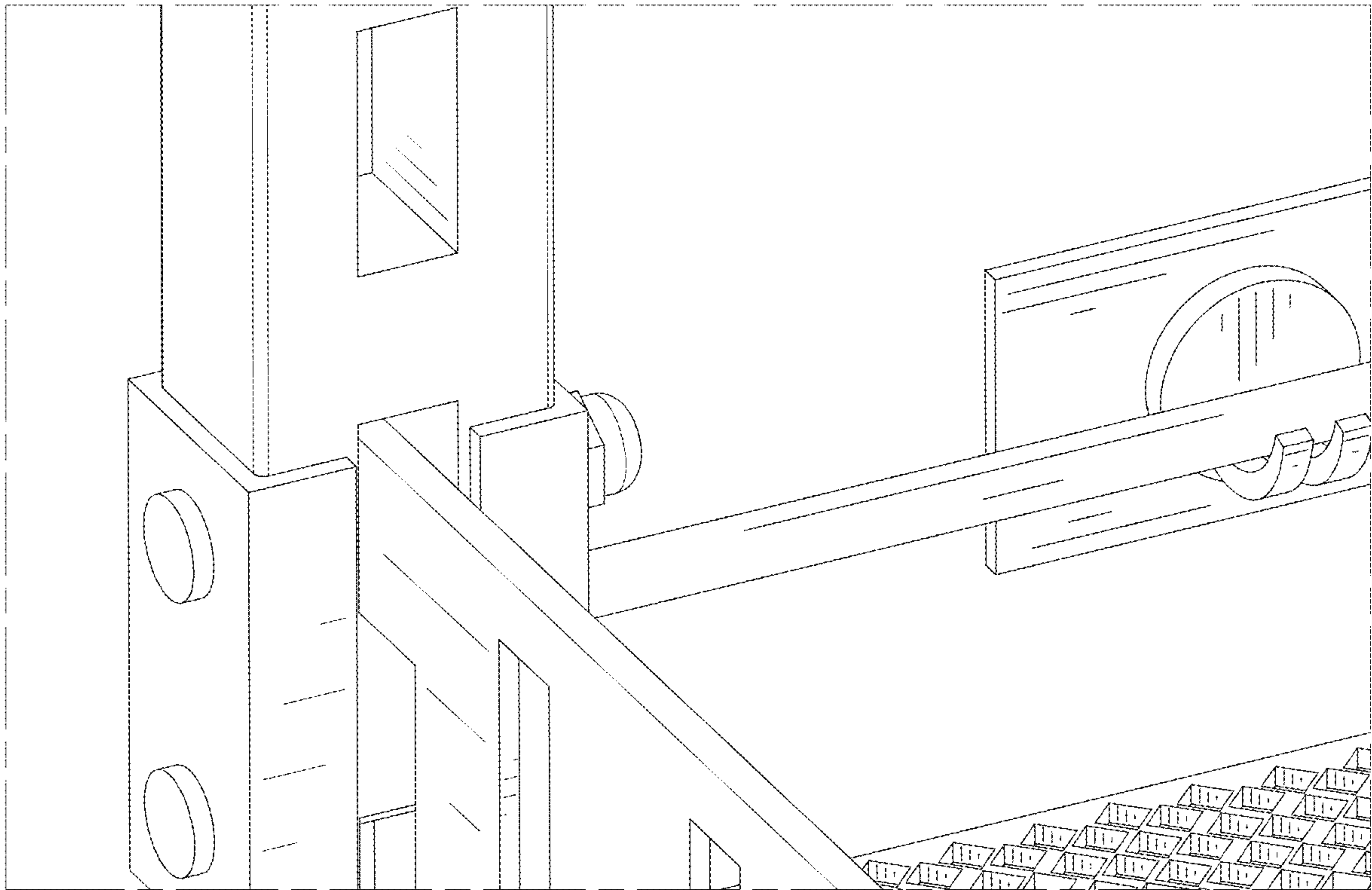

FIG. 17