



US00D988036S

(12) **United States Design Patent** (10) **Patent No.:** **US D988,036 S**  
**Duhadway** (45) **Date of Patent:** **\*\* Jun. 6, 2023**

(54) **CABINET**  
(71) Applicant: **WALKER EDISON FURNITURE COMPANY LLC**, West Jordan, UT (US)

D141,016 S 4/1945 Stanitz  
D142,049 S 8/1945 Waddell  
2,489,493 A 11/1949 Kuenzie  
D165,241 S 11/1951 Porter  
(Continued)

(72) Inventor: **Tiffany Duhadway**, Salt Lake City, UT (US)

**FOREIGN PATENT DOCUMENTS**

CN 304163895 9/2017  
CN 304770575 8/2018

(73) Assignee: **Walker Edison Furniture Company LLC**, West Jordan, UT (US)

(Continued)

(\*\*) Term: **15 Years**

**OTHER PUBLICATIONS**

(21) Appl. No.: **29/796,878**

Mid Century Modern Wood Kitchen Buffet by Walker Edison, first available: Jul. 23, 2020. Amazon.com [online], [site visited Nov. 29, 2022], Internet URL: <https://www.amazon.com/Walker-Edison-Mid-Century-Sideboard-Entryway/dp/B08DKC4P2J> (Year: 2020).\*

(22) Filed: **Jun. 28, 2021**

(51) **LOC (14) Cl.** ..... **06-04**

(52) **U.S. Cl.**  
USPC ..... **D6/657**

(58) **Field of Classification Search**  
USPC ..... D6/657, 662, 663, 664, 671, 671.1, D6/668.1, 662.1, 675

CPC ..... A47B 43/00; A47B 47/00; A47B 45/00; A47B 47/04; A47B 63/00; A47B 67/00; A47B 47/03; A47B 67/04; A47B 85/00; A47B 81/06; A47F 3/00

See application file for complete search history.

*Primary Examiner* — Mary Ann Calabrese  
*Assistant Examiner* — Hillary Catherine Shepard  
(74) *Attorney, Agent, or Firm* — Workman Nydegger

(57) **CLAIM**

The ornamental design for a cabinet, as shown and described.

**DESCRIPTION**

(56) **References Cited**

**U.S. PATENT DOCUMENTS**

1,097,697 A 5/1914 Weston  
D47,441 S 6/1915 Ullin  
D56,556 S 11/1920 Gray  
1,475,088 A 11/1923 Specht et al.  
1,538,393 A 5/1925 Martin  
D103,250 S 2/1937 Parrish  
2,099,387 A 11/1937 Cohn  
2,132,608 A 10/1938 Eaton  
D116,245 S 8/1939 Shucliff  
D120,370 S 5/1940 Bach  
2,207,307 A 7/1940 Teller

FIG. 1 is a front perspective view of a cabinet showing the new design;  
FIG. 2 is a front elevation view thereof;  
FIG. 3 is a back elevation view thereof;  
FIG. 4 is a left elevation view thereof;  
FIG. 5 is a right elevation view thereof;  
FIG. 6 is a top plan view thereof; and,  
FIG. 7 is a bottom plan view thereof.  
The broken lines shown in the figures illustrate portions of the cabinet that form no part of the claimed design.

**1 Claim, 5 Drawing Sheets**

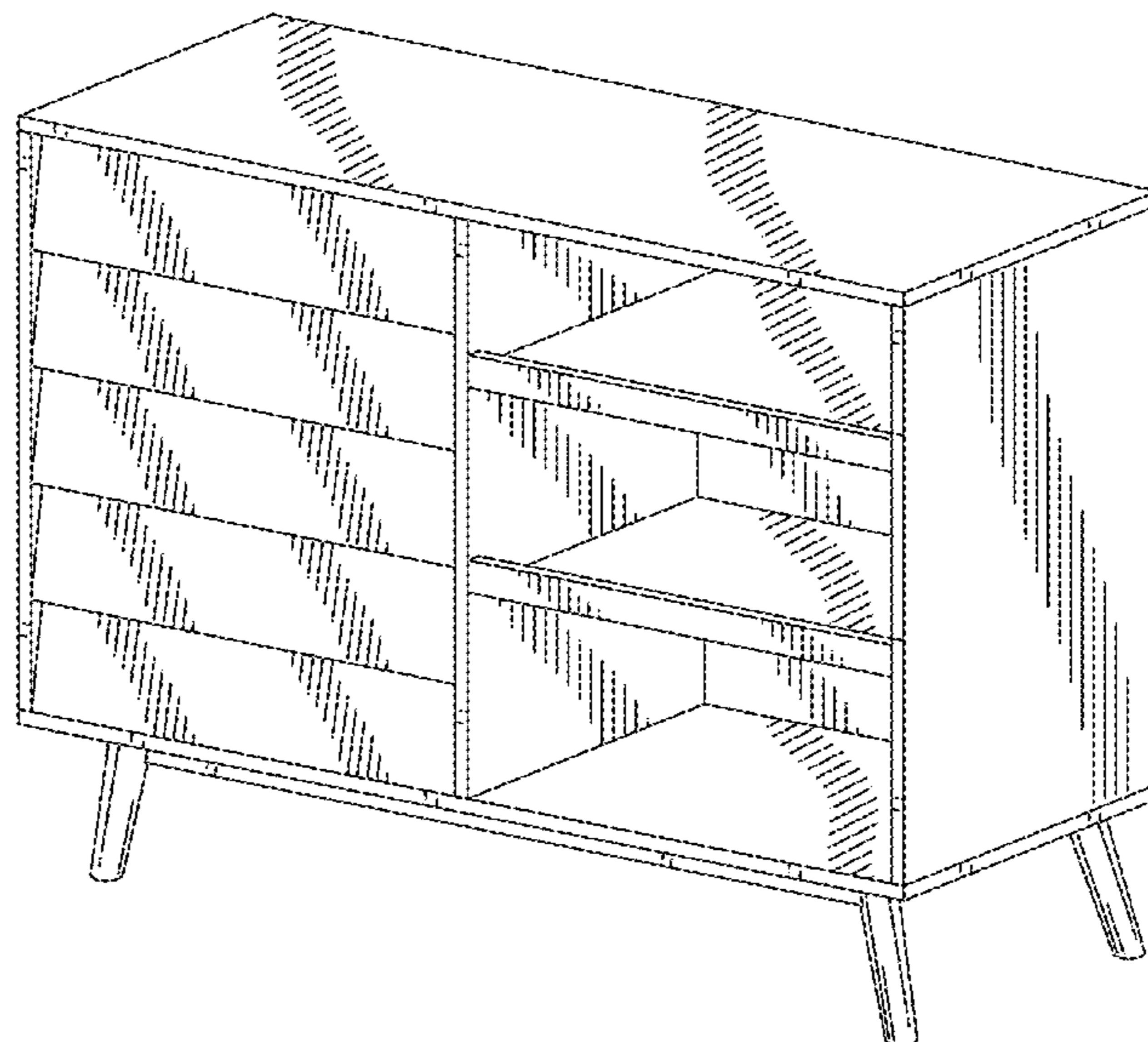

(56)

## References Cited

## U.S. PATENT DOCUMENTS

|              |         |                  |          |              |         |               |
|--------------|---------|------------------|----------|--------------|---------|---------------|
| D166,077 S   | 3/1952  | Haas             |          | D306,106 S   | 2/1990  | Bush          |
| D167,392 S * | 8/1952  | Carr .....       | D6/671.1 | D319,230 S   | 8/1991  | Sugiyama      |
| 2,696,419 A  | 12/1954 | Wallance         |          | 5,036,778 A  | 8/1991  | Briosi        |
| D175,869 S   | 10/1955 | Trout            |          | D319,743 S   | 9/1991  | Grey          |
| 2,743,720 A  | 5/1956  | Dollinger        |          | D321,571 S   | 11/1991 | Lucariello    |
| D182,832 S   | 5/1958  | Lubberts         |          | D322,184 S   | 12/1991 | Prevedello    |
| D182,836 S   | 5/1958  | Lubberts         |          | D325,680 S   | 4/1992  | Kiiski        |
| D183,838 S   | 5/1958  | Lubberts         |          | D327,735 S   | 7/1992  | Smith         |
| 2,836,871 A  | 6/1958  | Sidney           |          | D328,341 S   | 7/1992  | Chiu          |
| D183,577 S   | 9/1958  | McCarthy         |          | D329,693 S   | 9/1992  | Mills         |
| 2,850,346 A  | 9/1958  | Holderle         |          | D330,470 S   | 10/1992 | Bennett       |
| D183,788 S   | 10/1958 | Carter           |          | D336,184 S   | 6/1993  | Borgen        |
| 2,884,675 A  | 5/1959  | Richard          |          | D336,392 S   | 6/1993  | Whalen        |
| D185,936 S   | 8/1959  | Louis            |          | D347,754 S   | 6/1994  | Mehlin        |
| D186,113 S   | 9/1959  | Warren           |          | D348,576 S   | 7/1994  | Narramore     |
| D186,115 S   | 9/1959  | Church           |          | D348,726 S   | 7/1994  | Wilson        |
| 2,918,176 A  | 12/1959 | Bell             |          | D353,960 S   | 1/1995  | Barfield      |
| D187,232 S   | 2/1960  | Matyas           |          | 5,409,122 A  | 4/1995  | Lazarus       |
| D188,196 S   | 6/1960  | Lubberts         |          | D360,766 S   | 8/1995  | Sacchi        |
| D188,197 S   | 6/1960  | Swarts           |          | 5,452,812 A  | 9/1995  | Niequist      |
| D189,041 S   | 10/1960 | Jun Lunde        |          | D363,176 S   | 10/1995 | Berry         |
| 2,954,838 A  | 10/1960 | Mikael           |          | D363,841 S   | 11/1995 | Nourse        |
| 3,039,621 A  | 6/1962  | Pilcher          |          | D364,055 S   | 11/1995 | Pakla         |
| D193,516 S   | 9/1962  | Deaton           |          | D364,064 S   | 11/1995 | Lorenz        |
| D195,726 S   | 7/1963  | Harper           |          | 5,463,966 A  | 11/1995 | Nilsson       |
| D196,451 S   | 10/1963 | McMullen         |          | D365,472 S   | 12/1995 | Rehnberg      |
| 3,217,671 A  | 11/1965 | Walsh            |          | D366,110 S   | 1/1996  | Darr          |
| 3,272,582 A  | 9/1966  | Anderson et al.  |          | D367,383 S   | 2/1996  | Hatrick-Smith |
| 3,352,615 A  | 11/1967 | Sandin           |          | D373,693 S   | 9/1996  | Elhage        |
| 3,354,878 A  | 11/1967 | Balls            |          | D377,281 S   | 1/1997  | McFarlane     |
| 3,369,278 A  | 2/1968  | Humphreys        |          | 5,628,256 A  | 5/1997  | Lazarus       |
| D216,899 S   | 3/1970  | Thomas           |          | D384,227 S   | 9/1997  | Grosfillex    |
| D220,704 S   | 5/1971  | Kramer           |          | D385,431 S   | 10/1997 | Lee           |
| 3,589,746 A  | 6/1971  | Inglis           |          | 5,695,081 A  | 12/1997 | Alkalay       |
| RE27,186 E   | 10/1971 | Ferdinand        |          | D389,343 S   | 1/1998  | Van Der Merwe |
| RE27,200 E   | 10/1971 | Ferdinand et al. |          | D390,936 S   | 2/1998  | French        |
| 3,688,707 A  | 9/1972  | Maurice          |          | 5,752,500 A  | 5/1998  | Jamieson      |
| D226,832 S   | 5/1973  | Davis            |          | 5,765,265 A  | 6/1998  | Kang          |
| 3,762,789 A  | 10/1973 | Robertson        |          | 5,782,231 A  | 7/1998  | Wade          |
| 3,766,863 A  | 10/1973 | Swick            |          | D398,788 S   | 9/1998  | Schubert      |
| D230,446 S   | 2/1974  | Price            |          | 5,833,084 A  | 11/1998 | Chang         |
| D233,294 S   | 10/1974 | Goulder          |          | D403,529 S   | 1/1999  | De Blaay      |
| 3,855,637 A  | 12/1974 | Luger            |          | D404,937 S   | 2/1999  | Tarlow        |
| D236,676 S   | 9/1975  | Urti             |          | D407,577 S   | 4/1999  | Dorst         |
| D236,781 S   | 9/1975  | Cowley           |          | D408,174 S   | 4/1999  | Aspenwall     |
| D237,231 S   | 10/1975 | Wells            |          | D412,252 S   | 7/1999  | Zaidman       |
| D238,277 S   | 12/1975 | Parker           |          | D420,114 S   | 2/2000  | Johnson       |
| D239,352 S   | 3/1976  | Petrick          |          | D423,810 S   | 5/2000  | Dorst         |
| D239,893 S   | 5/1976  | Leonard          |          | D423,813 S   | 5/2000  | Paus          |
| D240,381 S   | 7/1976  | Tazaki           |          | D425,330 S   | 5/2000  | O'Hare        |
| D244,112 S   | 4/1977  | Friedman         |          | 6,074,029 A  | 6/2000  | Snoke         |
| D244,113 S   | 4/1977  | Friedman         |          | D428,609 S   | 7/2000  | Williams      |
| D248,429 S   | 7/1978  | Inohara          |          | D430,431 S   | 9/2000  | Walter        |
| D249,429 S   | 9/1978  | Robinson         |          | D438,727 S   | 3/2001  | McDaniel      |
| D249,860 S   | 10/1978 | Ungaro           |          | D440,079 S   | 4/2001  | Wohlford      |
| 4,182,244 A  | 1/1980  | Hutchins         |          | D446,047 S   | 8/2001  | Stone         |
| D259,316 S   | 5/1981  | Offredi          |          | D448,203 S   | 9/2001  | Jeup          |
| D262,847 S   | 2/1982  | Keller           |          | D449,184 S   | 10/2001 | Cain          |
| D267,532 S   | 1/1983  | Platner          |          | D450,492 S   | 11/2001 | Sabo          |
| D269,754 S   | 7/1983  | Kates            |          | D452,624 S   | 1/2002  | de Blois      |
| D270,858 S   | 10/1983 | McInnes          |          | D454,264 S   | 3/2002  | Patik         |
| D271,259 S   | 11/1983 | Smith            |          | D454,731 S   | 3/2002  | Niitsu        |
| D273,829 S   | 5/1984  | Desnoyers        |          | D454,732 S   | 3/2002  | Frenkler      |
| D274,152 S   | 6/1984  | Fleming          |          | D455,291 S   | 4/2002  | Jeup          |
| D281,901 S   | 12/1985 | Demrick          |          | D455,916 S   | 4/2002  | Fluhrer       |
| D283,182 S   | 4/1986  | Marshall         |          | 6,393,207 B1 | 5/2002  | Martin        |
| D283,343 S   | 4/1986  | Haythornthwaite  |          | D458,053 S   | 6/2002  | Luong         |
| D289,474 S   | 4/1987  | Underwood        |          | D462,008 S   | 8/2002  | Stone         |
| D293,177 S   | 12/1987 | Hamami           |          | D466,333 S   | 12/2002 | Hwang         |
| D293,521 S   | 1/1988  | Handler          |          | 6,515,262 B1 | 2/2003  | Li            |
| 4,793,667 A  | 12/1988 | Gilliom          |          | D473,404 S   | 4/2003  | De Blois      |
| D301,417 S   | 6/1989  | Wistehuff        |          | D475,225 S   | 6/2003  | McBrayer      |
| D303,596 S   | 9/1989  | Goetz            |          | D477,160 S   | 7/2003  | Grosfillex    |
| D304,982 S   | 12/1989 | Bush             |          | D478,432 S   | 8/2003  | Juneau        |
| D305,930 S   | 2/1990  | MacAleese        |          | D479,925 S   | 9/2003  | Hsieh         |
|              |         |                  |          | D480,237 S   | 10/2003 | de Carolis    |
|              |         |                  |          | D482,910 S   | 12/2003 | Jeup          |
|              |         |                  |          | D485,450 S   | 1/2004  | Smith         |
|              |         |                  |          | D485,709 S   | 1/2004  | de Blois      |



(56)

References Cited

U.S. PATENT DOCUMENTS

|              |         |                |          |              |         |             |
|--------------|---------|----------------|----------|--------------|---------|-------------|
| 6,672,465 B2 | 1/2004  | White          |          | D592,432 S   | 5/2009  | Sexton      |
| D486,015 S   | 2/2004  | De Blois       |          | 7,530,538 B2 | 5/2009  | Whalen      |
| D492,989 S   | 7/2004  | Beck           |          | D593,776 S   | 6/2009  | Sexton      |
| D495,527 S * | 9/2004  | Walker .....   | D6/657   | D594,248 S   | 6/2009  | Zambelli    |
| D495,898 S   | 9/2004  | Walker         |          | D595,979 S   | 7/2009  | Schweikarth |
| D496,543 S   | 9/2004  | Forlenza       |          | D598,672 S   | 8/2009  | Maly        |
| 6,789,859 B1 | 9/2004  | Ho             |          | D600,946 S   | 9/2009  | Day         |
| D497,741 S   | 11/2004 | Sexton         |          | D601,370 S   | 10/2009 | Kohler      |
| D498,962 S   | 11/2004 | Moon           |          | D604,546 S   | 11/2009 | Alman       |
| D499,274 S   | 12/2004 | Juneau         |          | D605,030 S   | 12/2009 | Kohler      |
| D499,281 S   | 12/2004 | Yamaguchi      |          | D605,874 S   | 12/2009 | Zambelli    |
| D499,582 S   | 12/2004 | McDiamid       |          | D606,331 S   | 12/2009 | Wicha       |
| D499,583 S   | 12/2004 | Anderson       |          | D607,243 S   | 1/2010  | Sugiyama    |
| D500,929 S   | 1/2005  | Walker         |          | D607,244 S   | 1/2010  | Nielsen     |
| D502,617 S   | 3/2005  | Chang          |          | D609,497 S   | 2/2010  | Kanhasamy   |
| D503,570 S   | 4/2005  | Anderson       |          | D609,503 S   | 2/2010  | Hayes       |
| D507,428 S   | 7/2005  | Weatherly      |          | D610,829 S   | 3/2010  | Nelson      |
| D507,899 S   | 8/2005  | Rozenboom      |          | D610,836 S   | 3/2010  | Kohler      |
| D507,900 S   | 8/2005  | Sexton         |          | D611,727 S   | 3/2010  | Vail        |
| D508,801 S   | 8/2005  | Holst          |          | D611,728 S   | 3/2010  | Nielsen     |
| D510,211 S   | 10/2005 | Welborn, Jr.   |          | D612,177 S   | 3/2010  | Marietta    |
| D517,349 S   | 3/2006  | Lara           |          | D612,178 S   | 3/2010  | Marietta    |
| D518,978 S   | 4/2006  | Katz           |          | D612,644 S   | 3/2010  | Marietta    |
| D519,203 S   | 4/2006  | Haas           |          | D613,964 S   | 4/2010  | Nielsen     |
| D519,299 S   | 4/2006  | Boudreau       |          | D614,888 S   | 5/2010  | Sexton      |
| D520,779 S   | 5/2006  | DeBlois        |          | D615,771 S   | 5/2010  | Kohler      |
| D522,771 S   | 6/2006  | Berry          |          | D615,772 S   | 5/2010  | Day         |
| D522,773 S   | 6/2006  | Becker         |          | D617,577 S   | 6/2010  | Day         |
| D524,080 S   | 7/2006  | Stenhouse      |          | D618,015 S   | 6/2010  | Sexton      |
| D526,143 S   | 8/2006  | Bruce          |          | D618,016 S   | 6/2010  | Metcalf     |
| D528,327 S   | 9/2006  | O'Reilly       |          | D620,277 S   | 7/2010  | Wyatt       |
| D529,317 S   | 10/2006 | Takatsuki      |          | D620,278 S   | 7/2010  | Zambelli    |
| D531,835 S * | 11/2006 | Harwanko ..... | D6/662.1 | D620,283 S   | 7/2010  | Calco       |
| D534,379 S   | 1/2007  | Juneau         |          | D622,834 S   | 8/2010  | Jiang       |
| D534,998 S   | 1/2007  | Charnick       |          | D623,442 S   | 9/2010  | Zambelli    |
| D536,770 S   | 2/2007  | Mayer          |          | D623,443 S   | 9/2010  | Zambelli    |
| D538,406 S   | 3/2007  | Mayer          |          | D623,876 S   | 9/2010  | Zambelli    |
| D539,057 S   | 3/2007  | Senda          |          | D623,877 S   | 9/2010  | Zambelli    |
| D539,565 S   | 4/2007  | Sexton, III    |          | D623,881 S   | 9/2010  | Schmidt     |
| D542,059 S   | 5/2007  | Moyle          |          | D625,123 S   | 9/2010  | Zambelli    |
| D543,057 S   | 5/2007  | Grady          |          | D630,453 S   | 1/2011  | Rafieha     |
| D543,488 S   | 5/2007  | Tobergte       |          | D632,902 S   | 2/2011  | Rafieha     |
| D543,728 S   | 6/2007  | Becker         |          | D637,849 S   | 5/2011  | Schmidt     |
| D548,488 S   | 8/2007  | Weatherly      |          | D638,922 S   | 5/2011  | Zhou        |
| D548,490 S   | 8/2007  | Becker         |          | 7,934,494 B1 | 5/2011  | Schneider   |
| D549,991 S   | 9/2007  | Stravitz       |          | D640,072 S   | 6/2011  | Sexton      |
| D552,334 S   | 10/2007 | Lee            |          | D641,861 S   | 7/2011  | Okamoto     |
| D553,879 S   | 10/2007 | Juneau         |          | D644,853 S   | 9/2011  | Becker      |
| D554,393 S   | 11/2007 | Yalif          |          | D648,152 S   | 11/2011 | Walker      |
| D554,897 S   | 11/2007 | Mayer          |          | 8,079,311 B2 | 12/2011 | Whalen      |
| D555,397 S   | 11/2007 | Yalif          |          | D652,232 S   | 1/2012  | Walker      |
| D559,017 S   | 1/2008  | Domack         |          | D653,051 S   | 1/2012  | Lin         |
| D559,583 S   | 1/2008  | Zambelli       |          | D653,739 S   | 2/2012  | Gibbs       |
| D559,584 S   | 1/2008  | Zambelli       |          | D654,289 S   | 2/2012  | Zambelli    |
| D559,585 S   | 1/2008  | Lara           |          | D654,995 S   | 2/2012  | Asofsky     |
| D560,077 S   | 1/2008  | Zambelli       |          | D654,996 S   | 2/2012  | Asofsky     |
| D560,396 S   | 1/2008  | Weatherly      |          | D655,946 S   | 3/2012  | Sexton      |
| D560,403 S   | 1/2008  | Domack         |          | D658,750 S   | 5/2012  | Nemes       |
| D560,930 S   | 2/2008  | Woodward       |          | 8,191,485 B1 | 6/2012  | Whalen      |
| D561,317 S   | 2/2008  | Ou             |          | D663,137 S   | 7/2012  | Andersen    |
| D562,597 S   | 2/2008  | Weatherly      |          | D663,138 S   | 7/2012  | Andersen    |
| D564,261 S   | 3/2008  | Sculler        |          | D665,897 S   | 8/2012  | Martin      |
| D564,789 S   | 3/2008  | deCarolis      |          | D666,281 S   | 8/2012  | Nemes       |
| D566,426 S   | 4/2008  | Stenhouse      |          | D667,653 S   | 9/2012  | Lenney      |
| D567,346 S   | 4/2008  | Lin            |          | D667,654 S   | 9/2012  | Lenney      |
| D578,319 S   | 10/2008 | Lim            |          | D668,475 S   | 10/2012 | Zambelli    |
| D579,233 S   | 10/2008 | LeToumeau      |          | D669,704 S   | 10/2012 | Zambelli    |
| D586,580 S   | 2/2009  | Lim            |          | D669,706 S   | 10/2012 | Zambelli    |
| D586,585 S   | 2/2009  | Hynes          |          | D669,707 S   | 10/2012 | Zambelli    |
| D587,483 S   | 3/2009  | Zambelli       |          | D670,105 S   | 11/2012 | Jespersen   |
| D587,484 S   | 3/2009  | Domack         |          | D671,769 S   | 12/2012 | Olson       |
| D587,497 S   | 3/2009  | Zambelli       |          | D674,891 S   | 1/2013  | Huang       |
| D588,831 S   | 3/2009  | Mohundro       |          | D675,716 S   | 2/2013  | Schwartz    |
| D589,280 S   | 3/2009  | Zambelli       |          | D677,074 S   | 3/2013  | Olson       |
| D591,533 S   | 5/2009  | Karsson        |          | D677,078 S   | 3/2013  | Lambright   |
|              |         |                |          | D687,250 S   | 8/2013  | Weatherly   |
|              |         |                |          | D694,873 S   | 12/2013 | Nemes       |
|              |         |                |          | D696,758 S   | 12/2013 | Ernst       |
|              |         |                |          | 8,607,776 B2 | 12/2013 | Jansson     |



(56)

References Cited

U.S. PATENT DOCUMENTS

|              |         |                 |               |         |              |        |
|--------------|---------|-----------------|---------------|---------|--------------|--------|
| 8,813,656 B1 | 8/2014  | Hazzard         | D825,959 S    | 8/2018  | Rockwell     |        |
| D716,288 S   | 10/2014 | O'Heron         | D829,026 S    | 9/2018  | Davis        |        |
| D717,081 S   | 11/2014 | Dworman         | D829,471 S    | 10/2018 | Fortmann     |        |
| D717,569 S   | 11/2014 | Davis           | D833,782 S    | 11/2018 | Amacher      |        |
| D718,956 S   | 12/2014 | Helser          | D834,354 S    | 11/2018 | Davis        |        |
| D718,957 S   | 12/2014 | Heiser          | D834,355 S    | 11/2018 | Davis        |        |
| D719,384 S   | 12/2014 | Sowers          | D835,437 S    | 12/2018 | Stukenberg   |        |
| D720,563 S   | 1/2015  | Burden          | D835,925 S    | 12/2018 | Denby        |        |
| D722,458 S   | 2/2015  | Chen            | D838,520 S    | 1/2019  | Knox         |        |
| D723,148 S   | 2/2015  | Lawrence        | D838,523 S    | 1/2019  | Yamamoto     |        |
| D723,843 S   | 3/2015  | Lai             | D843,756 S    | 3/2019  | Johnson      |        |
| 9,004,060 B2 | 4/2015  | Benedetti       | D845,041 S    | 4/2019  | Davis        |        |
| D728,280 S   | 5/2015  | Weatherly       | D845,679 S    | 4/2019  | Li           |        |
| D728,975 S   | 5/2015  | Park            | D845,683 S    | 4/2019  | Pedersen     |        |
| D730,089 S   | 5/2015  | Carbone         | D848,766 S    | 5/2019  | Chen         |        |
| D731,823 S   | 6/2015  | Kelinske        | D848,767 S    | 5/2019  | Smrstick     |        |
| D736,012 S   | 8/2015  | Davis           | D848,768 S    | 5/2019  | Johnson      |        |
| D737,418 S   | 8/2015  | Hrydovyy        | D848,770 S    | 5/2019  | Davis        |        |
| D737,603 S   | 9/2015  | Shah            | D849,457 S    | 5/2019  | Kundig       |        |
| D738,477 S   | 9/2015  | Nemes           | D850,815 S    | 6/2019  | Nicoll       |        |
| D738,647 S   | 9/2015  | Muller          | D851,426 S    | 6/2019  | Saotome      |        |
| D741,090 S   | 10/2015 | Ward            | D852,429 S    | 6/2019  | Rathman      |        |
| D741,630 S   | 10/2015 | Meissner        | D853,052 S    | 7/2019  | Rathman      |        |
| D742,142 S   | 11/2015 | Everson         | D856,038 S    | 8/2019  | Parikh       |        |
| D742,662 S   | 11/2015 | Muller          | D856,039 S    | 8/2019  | Parikh       |        |
| D743,192 S   | 11/2015 | Davis           | D862,132 S    | 8/2019  | Bhatt-Patel  |        |
| D746,614 S   | 1/2016  | Sheppard        | D858,148 S    | 9/2019  | Crutcher     |        |
| D747,123 S   | 1/2016  | Zambelli        | D859,038 S    | 9/2019  | Davis        |        |
| D747,788 S   | 1/2016  | Baker           | D860,687 S    | 9/2019  | Parikh       |        |
| D747,900 S   | 1/2016  | Sheppard        | D860,689 S    | 9/2019  | Davis        |        |
| 9,228,742 B2 | 1/2016  | Akiyama         | D861,388 S    | 10/2019 | Bray         |        |
| D748,768 S   | 2/2016  | Stanton         | D862,940 S    | 10/2019 | Bray         |        |
| D752,905 S   | 4/2016  | Healy           | D862,943 S    | 10/2019 | Nakamura     |        |
| D753,930 S   | 4/2016  | Vengadakrishnan | D862,944 S    | 10/2019 | Nakamura     |        |
| D757,350 S   | 5/2016  | Levy            | D863,841 S    | 10/2019 | Dumouchel    |        |
| D758,766 S   | 6/2016  | Kirar           | D864,627 S    | 10/2019 | Rockwell     |        |
| D759,997 S   | 6/2016  | Ruiz            | D866,225 S    | 11/2019 | Gelman       |        |
| D767,752 S   | 6/2016  | Davis           | D867,032 S    | 11/2019 | Bellini      |        |
| D767,753 S   | 9/2016  | Edmund          | 10,473,335 B2 | 11/2019 | Nemes et al. |        |
| D767,921 S   | 10/2016 | Burden          | D869,201 S *  | 12/2019 | Davis .....  | D6/669 |
| D768,413 S   | 10/2016 | Huang           | D869,202 S    | 12/2019 | Davis        |        |
| D773,862 S   | 12/2016 | Davis           | D870,492 S    | 12/2019 | Young        |        |
| D774,336 S   | 12/2016 | Pomputius       | D870,493 S    | 12/2019 | Young        |        |
| D775,866 S   | 1/2017  | Ben Avi         | D871,803 S    | 1/2020  | Young        |        |
| D777,479 S   | 1/2017  | Anderson        | D874,192 S    | 2/2020  | Velez        |        |
| D778,641 S   | 2/2017  | Anderson        | D878,116 S    | 3/2020  | Davis        |        |
| D778,646 S   | 2/2017  | Davis           | D878,816 S    | 3/2020  | Davis        |        |
| D783,324 S   | 4/2017  | Akana           | D878,817 S    | 3/2020  | Davis        |        |
| D791,302 S   | 7/2017  | Davis           | D878,822 S    | 3/2020  | Davis        |        |
| D791,522 S   | 7/2017  | Rafieha         | D878,823 S    | 3/2020  | Davis        |        |
| D792,132 S   | 7/2017  | Peota           | D879,516 S *  | 3/2020  | Davis .....  | D6/657 |
| D793,776 S   | 8/2017  | Davis           | D880,201 S    | 4/2020  | Kraemer      |        |
| D798,640 S   | 10/2017 | Anderson        | D882,989 S    | 5/2020  | Davis        |        |
| D804,861 S   | 12/2017 | Failing         | D885,091 S    | 5/2020  | Davis        |        |
| D805,329 S   | 12/2017 | Rockwell        | D886,499 S    | 6/2020  | Davis        |        |
| D807,671 S   | 1/2018  | Caillouet       | D888,467 S    | 6/2020  | Li           |        |
| D808,203 S   | 1/2018  | Davis           | D891,831 S    | 8/2020  | Davis        |        |
| D808,688 S   | 1/2018  | Everson         | D894,641 S    | 9/2020  | Davis        |        |
| D808,690 S   | 1/2018  | Hsu             | D896,013 S    | 9/2020  | Tan          |        |
| D812,938 S   | 3/2018  | Moore           | D900,510 S    | 11/2020 | Davis        |        |
| D814,410 S   | 4/2018  | Emslie          | D904,079 S    | 12/2020 | Davis        |        |
| D815,465 S   | 4/2018  | Hannoosh        | D904,082 S    | 12/2020 | Davis        |        |
| D817,037 S   | 5/2018  | Davis           | D904,084 S    | 12/2020 | Davis        |        |
| D817,038 S   | 5/2018  | Davis           | D904,801 S    | 12/2020 | Davis        |        |
| D817,040 S   | 5/2018  | Davis           | D904,802 S *  | 12/2020 | Davis .....  | D6/657 |
| D817,666 S   | 5/2018  | Davis           | D904,803 S    | 12/2020 | Davis        |        |
| D817,667 S   | 5/2018  | Davis           | D904,804 S    | 12/2020 | Davis        |        |
| D817,668 S   | 5/2018  | Davis           | D906,020 S    | 12/2020 | Davis        |        |
| D818,750 S   | 5/2018  | Hannoosh        | D906,021 S    | 12/2020 | Davis        |        |
| D821,038 S   | 6/2018  | Rathman         | D908,403 S    | 1/2021  | Cayouette    |        |
| D824,703 S   | 8/2018  | Yamamoto        | D908,404 S    | 1/2021  | Davis        |        |
| D825,225 S   | 8/2018  | Massaud         | D908,405 S    | 1/2021  | Davis        |        |
| D825,230 S   | 8/2018  | Massaud         | D909,797 S    | 2/2021  | Davis        |        |
| D825,232 S   | 8/2018  | Massaud         | D909,799 S    | 2/2021  | Nicoll       |        |
| D825,233 S   | 8/2018  | Yamamoto        | D912,442 S    | 3/2021  | Li           |        |
|              |         |                 | D912,443 S    | 3/2021  | Li           |        |
|              |         |                 | D914,400 S *  | 3/2021  | Davis .....  | D6/657 |
|              |         |                 | D916,537 S    | 4/2021  | Davis        |        |
|              |         |                 | D920,014 S    | 5/2021  | Chu          |        |



(56)

References Cited

U.S. PATENT DOCUMENTS

D920,015 S 5/2021 Ye  
 D922,798 S 6/2021 Packer  
 D922,799 S 6/2021 Davis  
 D922,804 S 6/2021 van Thiel  
 D926,500 S 8/2021 Davis  
 D927,897 S 8/2021 Chu  
 D927,898 S 8/2021 Davis  
 D922,106 S 9/2021 Li  
 D931,016 S 9/2021 Davis  
 D931,662 S 9/2021 Davis  
 D932,812 S 10/2021 Hu  
 D935,237 S 11/2021 Davis  
 D935,244 S 11/2021 Packer  
 D939,252 S 12/2021 Barris  
 D941,064 S 1/2022 Packer  
 D942,782 S 2/2022 Li  
 D945,187 S 3/2022 Packer  
 D946,317 S 3/2022 Packer  
 D946,319 S 3/2022 Packer  
 D946,936 S 3/2022 Davis  
 D947,580 S 4/2022 Packer  
 D947,581 S 4/2022 Packer  
 D948,250 S 4/2022 Davis  
 D948,251 S 4/2022 Li  
 D948,896 S 4/2022 Chu  
 D951,683 S \* 5/2022 Davis ..... D6/657  
 D951,684 S 5/2022 Packer  
 D954,475 S 6/2022 Packer  
 D958,568 S 7/2022 Packer  
 D958,569 S 7/2022 Davis  
 D967,656 S 10/2022 Li  
 2004/0074858 A1 4/2004 Thuma  
 2004/0079714 A1 4/2004 Andrew  
 2004/0160087 A1 8/2004 Tiesler  
 2004/0222721 A1 11/2004 Kelley  
 2004/0237853 A1 12/2004 Sholz  
 2005/0000241 A1 1/2005 Kucera  
 2005/0103734 A1 5/2005 Saltzberg  
 2007/0062983 A1 3/2007 Barnett  
 2007/0138119 A1 6/2007 Schwerdlin  
 2007/0236111 A1 10/2007 Gray  
 2007/0236113 A1 10/2007 McCambridge  
 2008/0116771 A1 5/2008 Green  
 2008/0181587 A1 7/2008 Patil  
 2008/0203042 A1 8/2008 Felsenthal  
 2008/0216817 A1 9/2008 Yungbluth  
 2009/0025414 A1 1/2009 Koga  
 2009/0151375 A1 6/2009 Tarr  
 2009/0170421 A1 7/2009 Adrian  
 2009/0220221 A1 9/2009 Zhou  
 2010/0307179 A1 12/2010 Fava  
 2011/0000477 A1 1/2011 Kwon  
 2011/0011816 A1 1/2011 Marietta  
 2011/0012481 A1 1/2011 Becker  
 2011/0017691 A1 1/2011 Wu  
 2011/0017692 A1 1/2011 Marietta  
 2011/0079688 A1 4/2011 Grove  
 2011/0080261 A1 4/2011 Asofsky  
 2011/0120166 A1 5/2011 Nadel  
 2011/0220090 A1 9/2011 Atemboski  
 2013/0052388 A1 2/2013 Burrows  
 2014/0116418 A1 5/2014 Thomas  
 2014/0239136 A1 8/2014 Ortega  
 2014/0252939 A1 9/2014 Tunzi  
 2014/0265754 A1 9/2014 Patterson  
 2014/0265807 A1 9/2014 Kendall  
 2014/0318529 A1 10/2014 Nielsen  
 2015/0027349 A1 1/2015 Kahle  
 2015/0182021 A1 7/2015 Chang  
 2015/0323190 A1 11/2015 Stein  
 2016/0018112 A1 1/2016 Phillips  
 2016/0100698 A1 4/2016 Clark  
 2016/0157605 A1 6/2016 Grad  
 2016/0195277 A1 7/2016 Li  
 2016/0209102 A1 7/2016 Vulava

2016/0223213 A1 8/2016 Grohova  
 2016/0256032 A1 9/2016 Bhajak  
 2017/0089587 A1 3/2017 Nemes  
 2017/0211814 A1 7/2017 Bourne  
 2018/0029270 A1 2/2018 Hepler  
 2018/0053974 A1 2/2018 Lee  
 2018/0064246 A1 3/2018 Kassanoff  
 2021/0088221 A1 3/2021 Crowe  
 2021/0404667 A1 12/2021 Crowe

FOREIGN PATENT DOCUMENTS

CN 305138614 5/2019  
 EM 003068485-0003 4/2016  
 EM 003254200-0003 6/2016  
 EM 005646783-0006 9/2018  
 GB 1162368 8/1969  
 GB 4001474 5/2007  
 GB 4032905 11/2013  
 GB 4034171 7/2014  
 GB 6041896 8/2018  
 WO WOD076242-061 5/2011

OTHER PUBLICATIONS

Brumley Bar Cabinet by Mercury Row, first available: Oct. 9, 2020. Wayfair.com [online], [site visited Nov. 29, 2022], Internet URL: <https://www.wayfair.com/furniture/pdp/mercury-row-brumley-bar-cabinet-w003334232.html?piid=979483491#jhl7htybdbf-3> (Year: 2020).\*

Notice of Allowance for U.S. Appl. No. 29/721,166, dated Jan. 26, 2023.

Walker Edison Sedalia Modern Farmhouse Metal X Entryway Bench, available in Amazon.com, customer review oldest date Jan. 18, 2020 [online], Retrieved on Dec. 20, 2022 from URL: <https://www.amazon.com/WE-Furniture-Farmhouse-Entryway-Organizer/dp/B07TGF5SRBH/> (Year: 2020).

Lavish Home, Espresso 60-inch TV Stand—Entertainment Center with Media Console Shelves, Cable Management, and Sliding Barn Style Doors, Woodgrain; <https://www.amazon.com/Lavish-Home-Espresso-60-inch-Stand/dp/B09WZ87ZBZ>; Retrieved Feb. 7, 2023.

Lavish Home Buffet Cabinet Entryway Table with X-Pattern Glass Doors, White; <https://www.walmart.com/ip/Lavish-Home-Buffet-Cabinet-Entryway-Table-with-X-Pattern-Glass-Doors-White/825204518?fulfillmentIntent=Shipping>; retrieved on Feb. 7, 2023.

Lavish Home Tall TV Stand, Brown; [https://www.amazon.com/Lavish-Home-Tall-Stand-Brown/dp/B09SBTBC11/ref=sr\\_1\\_5?crid=17UAPZU78Z9GN&keywords=lavish+home+tv+stand&qid=1670869751&sprefix=lavish+home+tv+stan%2Caps%2C144&sr=8-5](https://www.amazon.com/Lavish-Home-Tall-Stand-Brown/dp/B09SBTBC11/ref=sr_1_5?crid=17UAPZU78Z9GN&keywords=lavish+home+tv+stand&qid=1670869751&sprefix=lavish+home+tv+stan%2Caps%2C144&sr=8-5); retrieved on Feb. 7, 2023.

Lavish Home, Espresso Entertainment Center; <https://www.amazon.com/Lavish-Home-Espresso-Entertainment-Center/dp/B0BFFV6ZHM>; Retrieved on Feb. 7, 2023.

65-inch TV Stand—2-Door Entertainment Center, Adjustable Media Console Shelves, Cable Management and Farmhouse Style by Lavish Home (Gray Woodgrain); <https://www.target.com/p/65-inch-tv-stand-2-door-entertainment-center-adjustable-media-console-shelves-cable-management-and-farmhouse-style-by-lavish-home-gray-woodgrain/-/A-88052253#Ink=sametab>; retrieved on Feb. 7, 2023.

Lavish Home 65-inch TV Stand with Media Console Shelves, Cable Management, and Sliding X-Style Barn Doors, Gray Woodgrain; <https://www.target.com/p/lavish-home-65-inch-tv-stand-with-media-console-shelves-cable-management-and-sliding-x-style-barn-doors-gray-woodgrain/-/A-86096559#Ink=sametab>; Feb. 7, 2023.

Meuble télé Farmhouse de 68 po Farmhouse; <https://www.wayfair.ca/fr/mobilier/pdp/gracie-oaks-meuble-tele-farmhouse-de-68-po-farmhouse-c007499050.html?piid=569727925>; retrieved on Feb. 7, 2023.

Meuble télé Farmhouse de 68 po Farmhouse; <https://www.wayfair.ca/fr/mobilier/pdp/gracie-oaks-meuble-tele-farmhouse-de-68-po-farmhouse-c007499050.html?piid=569727924>; retrieved on Feb. 7, 2023.



(56)

**References Cited**

## OTHER PUBLICATIONS

Auxsoul Mid Century Modern TV Stand for 75 Inch TV, 70 Inch TV Stand with Storage, Entertainment Center for Living Room Bedroom, TV Media Console, White & Oak; <https://www.amazon.com/dp/B0B5XNFGFP>; retrieved on Feb. 7, 2023.

Farmhouse Coffee Bar Cabinet White Modern Kitchen Sliding Barn Door Buffet Storage Cabinet Credenza Sideboard Buffet Cabinet with Storage Shelf Wood Accent Liquor Cabinet for Dining Room, White; <https://www.amazon.com/dp/B09XJVZ3HZ?th=1>; retrieved on Feb. 7, 2023.

4 Ever Winner Farmhouse Coffee Bar Cabinet with Storage, Sideboard Storage Cabinet with Barn Doors, Coffee Bar Cabinet Accent Cabinets with Drawer for Living Room, Entryway, Dining Room, Grey Wash; <https://www.amazon.com/dp/B0BN5T7LNQ>; retrieved on Feb. 7, 2023.

Farmhouse TV Stand for TVs up to 50 inch, Entertainment Center with Sliding Barn Door Media Console Table Living Room Bedroom, Walnut; <https://www.amazon.com/dp/B09Y5DS6XK>; retrieved on Feb. 7, 2023.

Farmhouse Coffee Bar Cabinet with Sliding Barn Doors, Rustic Brown Buffet Storage Sideboard Cabinet with 4 Adjustable Shelves for Kitchen, 52" Credenza Sideboard with Storage Cabinet for Dining Room; <https://www.amazon.com/dp/B09ZRS1J1H>; retrieved on Feb. 7, 2023.

Farmhouse Coffee Bar Cabinet with Storage, 52" White Buffet Sideboard Storage Cabinet with Sliding Barn Door, Tall Kitchen Cupboard Storage Credenza Cabinet with Wooden Tabletop for Dining Room; <https://www.amazon.com/dp/B0BCWZVT9F>; retrieved on Feb. 7, 2023.

Coffee Bar Cabinet with Storage, Farmhouse Buffet Sideboard Storage Cabinet with Sliding Barn Door, Coffee Nook Cabinet, Grey; <https://www.amazon.com/dp/B09Y8P9KLM>; retrieved on Feb. 7, 2023.

Office Action for U.S. Appl. No. 29/794,351, dated Feb. 9, 2023.

Coridon 59" Media Console by Gracie Oaks, first available: Sep. 23, 2019. Wayfair.com [online], [site visited Jan. 18, 2023], Internet URL: <https://www.wayfair.com/furniture/pdp/gracie-oaks-coridon-tv-stand-for-tvs-up-to-65-w003215495.html> (Year: 2019).

Notice of Allowance for U.S. Appl. No. 29/794,592, dated Feb. 14, 2023.

U.S. Appl. No. 29/767,919, filed Dec. 21, 2022, Notice of Allowance.

U.S. Appl. No. 29/767,917, filed Jan. 3, 2023, Notice of Allowance.

U.S. Appl. No. 29/756,302, filed Jan. 5, 2023, Notice of Allowance.

U.S. Appl. No. 29/611,963, filed Jul. 27, 2017, Davis.

U.S. Appl. No. 29/634,946, filed Jan. 25, 2018, Davis.

U.S. Appl. No. 29/654,950, filed Jun. 28, 2018, Davis.

U.S. Appl. No. 29/720,093, filed Jan. 9, 2020, Davis.

U.S. Appl. No. 29/656,499, filed Jul. 12, 2018, Davis.

U.S. Appl. No. 29/656,479, filed Jul. 12, 2018, Davis.

U.S. Appl. No. 29/656,485, filed Jul. 12, 2018, Davis.

U.S. Appl. No. 29/656,486, filed Jul. 12, 2018, Davis.

U.S. Appl. No. 29/656,497, filed Jul. 12, 2018, Davis.

U.S. Appl. No. 29/654,930, filed Jun. 28, 2018, Davis.

U.S. Appl. No. 29/654,936, filed Jun. 28, 2018, Davis.

U.S. Appl. No. 29/654,952, filed Jun. 28, 2018, Davis.

U.S. Appl. No. 29/656,492, filed Jul. 12, 2018, Davis.

U.S. Appl. No. 29/656,489, filed Jul. 12, 2018, Davis.

U.S. Appl. No. 29/634,889, filed Jan. 25, 2018, Davis.

U.S. Appl. No. 29/677,722, filed Jan. 23, 2019, Davis.

U.S. Appl. No. 29/677,723, filed Jan. 23, 2019, Davis.

U.S. Appl. No. 29/677,724, filed Jan. 23, 2019, Davis.

U.S. Appl. No. 29/677,738, filed Jan. 23, 2019, Davis.

U.S. Appl. No. 29/677,755, filed Jan. 23, 2019, Davis.

U.S. Appl. No. 29/677,761, filed Jan. 23, 2019, Davis.

U.S. Appl. No. 29/698,919, filed Jul. 22, 2019, Davis.

U.S. Appl. No. 29/773,569, filed Mar. 10, 2021, Davis.

U.S. Appl. No. 29/756,291, filed Oct. 27, 2020, Davis.

U.S. Appl. No. 29/756,302, filed Oct. 27, 2020, Davis.

U.S. Appl. No. 29/756,303, filed Oct. 27, 2020, Davis.

U.S. Appl. No. 29/756,305, filed Oct. 27, 2020, Davis.

U.S. Appl. No. 29/698,924, filed Jul. 22, 2019, Davis.

U.S. Appl. No. 29/698,928, filed Jul. 22, 2019, Davis.

U.S. Appl. No. 29/698,940, filed Jul. 22, 2019, Davis.

U.S. Appl. No. 29/756,763, filed Oct. 30, 2020, Davis.

U.S. Appl. No. 29/699,063, filed Jul. 23, 2019, Davis.

U.S. Appl. No. 29/699,066, filed Jul. 23, 2019, Davis.

U.S. Appl. No. 29/714,849, filed Nov. 26, 2019, Davis.

U.S. Appl. No. 29/699,071, filed Jul. 23, 2019, Davis.

U.S. Appl. No. 29/699,073, filed Jul. 23, 2019, Davis.

U.S. Appl. No. 29/699,078, filed Jul. 23, 2019, Davis.

U.S. Appl. No. 29/698,942, filed Jul. 22, 2019, Davis.

U.S. Appl. No. 29/698,947, filed Jul. 22, 2019, Davis.

U.S. Appl. No. 29/720,729, filed Jan. 15, 2020, Davis.

U.S. Appl. No. 29/720,732, filed Jan. 15, 2020, Davis.

U.S. Appl. No. 29/721,435, filed Jan. 21, 2020, Davis.

U.S. Appl. No. 29/720,734, filed Jan. 15, 2020, Davis.

U.S. Appl. No. 29/720,923, filed Jan. 16, 2020, Davis.

U.S. Appl. No. 29/720,927, filed Jan. 16, 2020, Davis.

U.S. Appl. No. 29/720,942, filed Jan. 16, 2020, Davis.

U.S. Appl. No. 29/720,948, filed Jan. 16, 2020, Davis.

U.S. Appl. No. 29/721,166, filed Jan. 17, 2020, Davis.

U.S. Appl. No. 29/743,237, filed Jul. 20, 2020, Packer.

U.S. Appl. No. 29/743,240, filed Jul. 20, 2020, Packer.

U.S. Appl. No. 29/743,244, filed Jul. 20, 2020, Packer.

U.S. Appl. No. 29/743,246, filed Jul. 20, 2020, Packer.

U.S. Appl. No. 29/743,247, filed Jul. 20, 2020, Packer.

U.S. Appl. No. 29/743,250, filed Jul. 20, 2020, Packer.

U.S. Appl. No. 29/743,416, filed Jul. 21, 2020, Packer.

U.S. Appl. No. 29/743,418, filed Jul. 21, 2020, Packer.

U.S. Appl. No. 29/743,423, filed Jul. 21, 2020, Packer.

U.S. Appl. No. 29/743,584, filed Jul. 22, 2020, Packer.

U.S. Appl. No. 29/728,971, filed Mar. 23, 2020, Davis.

U.S. Appl. No. 29/767,917, filed Jan. 26, 2021, Duhadway.

U.S. Appl. No. 29/767,919, filed Jan. 26, 2021, Naylor.

U.S. Appl. No. 29/768,116, filed Jan. 27, 2021, Naylor.

U.S. Appl. No. 29/785,130, filed May 24, 2021, Duhadway.

U.S. Appl. No. 29/785,154, filed May 24, 2021, Duhadway.

U.S. Appl. No. 29/794,351, filed Jun. 11, 2021, Naylor.

U.S. Appl. No. 29/794,592, filed Jun. 14, 2021, Naylor.

U.S. Appl. No. 29/797,119, filed Jun. 29, 2021, Duhadway.

U.S. Appl. No. 29/794,596, filed Jun. 14, 2021, Naylor.

U.S. Appl. No. 29/794,737, filed Jun. 15, 2021, Duhadway.

U.S. Appl. No. 29/796,882, filed Jun. 28, 2021, Duhadway.

U.S. Appl. No. 29/794,743, filed Jun. 15, 2021, Duhadway.

U.S. Appl. No. 29/801,171, filed Jul. 27, 2021, Duhadway.

U.S. Appl. No. 29/801,173, filed Jul. 27, 2021, Naylor.

U.S. Appl. No. 29/799,389, filed Jul. 14, 2021, Duhadway.

U.S. Appl. No. 29/801,175, filed Jul. 27, 2021, Duhadway.

U.S. Appl. No. 29/808,729, filed Sep. 22, 2021, Duhadway.

U.S. Appl. No. 29/808,735, filed Sep. 22, 2021, Duhadway.

U.S. Appl. No. 29/814,099, filed Nov. 3, 2021, Naylor.

U.S. Appl. No. 29/818,613, filed Dec. 9, 2021, Beckstead.

U.S. Appl. No. 29/818,153, filed Dec. 7, 2021, Duhadway.

U.S. Appl. No. 29/818,157, filed Dec. 7, 2021, Duhadway.

U.S. Appl. No. 29/815,518, filed Nov. 15, 2021, Packer.

U.S. Appl. No. 29/815,516, filed Nov. 15, 2021, Packer.

U.S. Appl. No. 29/818,147, filed Dec. 7, 2021, Naylor.

U.S. Appl. No. 29/823,713, filed Jan. 19, 2022, Duhadway.

U.S. Appl. No. 29/823,716, filed Jan. 19, 2022, Duhadway.

U.S. Appl. No. 29/824,461, filed Jan. 25, 2022, Duhadway.

U.S. Appl. No. 29/825,551, filed Feb. 2, 2022, Naylor.

U.S. Appl. No. 29/792,312, filed Mar. 21, 2022, Duhadway.

U.S. Appl. No. 29/792,313, filed Mar. 21, 2022, Naylor.

U.S. Appl. No. 29/792,314, filed Mar. 21, 2022, Naylor.

U.S. Appl. No. 29/831,492, filed Mar. 21, 2022, Beckstead.

U.S. Appl. No. 29/830,020, filed Mar. 9, 2022, Naylor.

U.S. Appl. No. 29/845,266, filed Jul. 6, 2022, Scott.

U.S. Appl. No. 29/865,174, filed Jul. 12, 2022, Naylor.

U.S. Appl. No. 29/845,776, filed Jul. 11, 2022, Beckstead.

U.S. Appl. No. 29/806,955, filed Sep. 8, 2021, Duhadway.

U.S. Appl. No. 29/806,959, filed Sep. 8, 2021, Naylor.

U.S. Appl. No. 29/805,787, filed Aug. 30, 2021, Naylor.



(56)

## References Cited

## OTHER PUBLICATIONS

Electric fireplace, image post date May 26, 2014, site visited Aug. 8, 2016, (online), <<https://www.tineye.com/search/3c3d0cbfb7030b3079ebefa0774a5b4e94120332/?pluginver>>.

Media Console with Electric Fireplace, image post date Dec. 6, 2015, site visited Aug. 8, 2016, (online), <<http://www.overstock.com/Home-Garden/Media-Console-with-Electric-Fireplace-in-Barnwood/10309735/product.html?recset=05953330-aaa1-4640-a796-f225c2f8176d&refccid=MRISGBB2MZGZXYKK4EFV125H6Q&recalg=809,828,512&recidx=1#reviews>>.

Tv Stand With Fireplace, image post date Sep. 12, 2015, site visited Aug. 8, 2016, (online), <<https://www.tineye.com/search/77be8934bf07249cbb245c8ea0f719199437b185/>>.

Walker Edison TV Stand with Fireplace Insert, image post date Jul. 31, 2015, site visited Aug. 8, 2016, (online), <<https://www.amazon.com/Walker-Edison-Fireplace-Insert-Espresso/dp/BOOPNONTAK>>.

Manchester Fireplace TV Console, image post date Dec. 17, 2015, site visited Aug. 8, 2016, (online), <<http://www.walmart.com/ip/Manchester-Media-Fireplace-Stand-for-TVs-up-to-70/46360223>>.

Monet Fireplace; Canadian Tire Company website: <http://www.canadiantire.ca/en/pdp/monet-fireplace-0643572p.html>; retrieved on Dec. 21, 2016.

TV and Media Consoles, image post date Sep. 21, 2013, site visited Oct. 26, 2016, (online), <<http://web.archive.org/web/20130921074219/http://www.electrificfireplacesdirect.com/Gallery/tv-and-media-consoles.html>>.

"Kendall Electric Media Fireplace—Espresso" Dec. 24, 2012, amazon.com, site visited Mar. 6, 2018 <[https://www.amazon.com/Kendall-Electric-Media-Fireplace-Espresso/dp/B009LIT6XQ/ref=cm\\_cr\\_arp\\_d\\_product\\_top?ie=UTF8](https://www.amazon.com/Kendall-Electric-Media-Fireplace-Espresso/dp/B009LIT6XQ/ref=cm_cr_arp_d_product_top?ie=UTF8)> (Year: 2012).

"Whalen Media Fireplace Console for TVs up to 70" Gray" Nov. 24, 2015, walmart.com, site visited Mar. 6, 2018 <<https://www.walmart.com/ip/Whalen-Media-Fireplace-Console-for-TVs-up-to-70-Gray/54189794>> (Year: 2015).

"Boston Loft Furnishings . . ." Nov. 7, 2016, themine.com, site visited Mar. 2, 2018 <[https://www.themine.com/tv-stands/boston-loft-furnishings-reamrock-infrared-electric-fireplace-media-stand-with-convertible-corner\\_g2733659.html](https://www.themine.com/tv-stands/boston-loft-furnishings-reamrock-infrared-electric-fireplace-media-stand-with-convertible-corner_g2733659.html)> (Year: 2016).

"Ameriwood Home Everett 70-inch . . ." Dec. 6, 2016, overstock.com, site visited Mar. 2, 2018 <<https://www.overstock.com/Home-Garden/Ameriwood-Home-Everett-70-inch-Sonoma-Oak-TV-Stand-with-Glass-Doors/12710691/product.html>> (Year: 2016).

Metal Coffee Table; <https://www.overstock.com/Home-Garden/42-Metal-Coffee-Table-42-x-24-x-18h/15951452/product.html> Retrieved on Nov. 13, 2018.

Modern Two-Tone Writing Desk; <https://www.overstock.com/Home-Garden/44-Modern-Two-Tone-Writing-Desk/19684325/product.html> Retrieved on Nov. 13, 2018.

Czapla TV Stand for TVs up to 65"; <https://www.allmodern.com/furniture/pdp/mercury-row-czapla-tv-stand-for-tvs-up-to-65-a000303456.html> ; Retrieved on May 7, 2019.

Nelson Media Cabinet; <https://www.franceandson.com/collections/storage-shelving-media-cabinets/products/nelson-media-cabinet36051> ; Retrieved on May 7, 2019.

Hal TV Stand for TVs up to 60"; <https://www.allmodern.com/furniture/pdp/hal-tv-stand-for-tvs-up-to-60-a000176456.html> ; Retrieved on May 7, 2019.

Wigington TV Stand for TVs up to 60"; <https://www.allmodern.com/furniture/pdp/wigington-tv-stand-for-tvs-up-to-60-golv3670.html?piid> ; Retrieved on May 7, 2019.

Cliffmay Slat Media Stand Light Oak Brown—Project 62; [https://www.target.com/p/cliffmay-slat-media-stand-light-oak-brown-project-62-153/-/A-53517373?ref=tgt\\_adv\\_XS000000&AFID=google\\_pla\\_df&fndsrc=tgtao&CPNG=PLA\\_Furniture%2BShopping\\_Priority%2BBrands&adgroup=SC\\_Project+62&LID=700000001170770pgs&network=g&device=c&location=9029756&gclid=aw.ds&ds\\_rl=1246978&ds\\_rl=1247068&ds\\_rl=1246978&ref=tgt\\_adv\\_XS000000&AFID=google\\_pla\\_df&CPNG=PLA\\_Furniture+Shopping\\_Priority+Brands&adgroup=SC\\_Project%2062&LID=700000001170770pgs](https://www.target.com/p/cliffmay-slat-media-stand-light-oak-brown-project-62-153/-/A-53517373?ref=tgt_adv_XS000000&AFID=google_pla_df&fndsrc=tgtao&CPNG=PLA_Furniture%2BShopping_Priority%2BBrands&adgroup=SC_Project+62&LID=700000001170770pgs&network=g&device=c&location=9029756&gclid=aw.ds&ds_rl=1246978&ds_rl=1247068&ds_rl=1246978&ref=tgt_adv_XS000000&AFID=google_pla_df&CPNG=PLA_Furniture+Shopping_Priority+Brands&adgroup=SC_Project%2062&LID=700000001170770pgs)

&network=g&device=c&location=9029756&gclid=EAIalQobChMI7Nb9wo-H3wIVBylpCh1fSg4IEAQYBSABEgK\_yPD\_BwE&gclid=aw.ds ; Retrieved on May 7, 2019.

Audrey Woven Media Console 65"; <https://www.zinhome.com/audrey-woven-media-console-65/> ; Retrieved on May 14, 2019.

Demilune Mesh Door Industrial Sideboard; [https://belleescape.com/demilune-mesh-wire-door-industrial-chic-sideboard.html?\\_SID=U](https://belleescape.com/demilune-mesh-wire-door-industrial-chic-sideboard.html?_SID=U) ; Retrieved on May 14, 2019.

Tuk Cabinet; <https://blackroosterdecor.com/collections/storage-products/tuk-cabinet> ; Retrieved on May 14, 2019.

Rustic Style 31 Inches Metal TV Stand With Wire Mesh Doors Cabinet, Black; <https://casagear.com/products/rustic-style-31-inches-metal-tv-stand-with-wire-mesh-doors-cabinet-black>; May 14, 2019.

Geo-Marquetry Buffet; [https://www.anthropologie.com/shop/geo-marquetry-buffet?adpos=1o27&adtype=pla&cm\\_mmc=Google-US%20-%20Shopping%20-%20Furniture-Organizing%20and%20Storage-42699934&color=&countryCode=US&creative=191389729567&device=c&gclid=EAIalQobChMlvuTGgYOH3wIVEdNkCh3t8wRPEAkYGyABEgJG\\_PD\\_BwE&inventoryCountry=US&matchtype=&mrkgadid=3202938336&mrkgcl=694&network=g&product\\_id=42699934&quantity=1&size=ALL&type=STANDARD&utm\\_campaign=US%20-%20Shopping%20-%20Furniture&utm\\_content=42699934&utm\\_medium=paid\\_search&utm\\_source=Google&utm\\_term=Organizing%20and%20Storage](https://www.anthropologie.com/shop/geo-marquetry-buffet?adpos=1o27&adtype=pla&cm_mmc=Google-US%20-%20Shopping%20-%20Furniture-Organizing%20and%20Storage-42699934&color=&countryCode=US&creative=191389729567&device=c&gclid=EAIalQobChMlvuTGgYOH3wIVEdNkCh3t8wRPEAkYGyABEgJG_PD_BwE&inventoryCountry=US&matchtype=&mrkgadid=3202938336&mrkgcl=694&network=g&product_id=42699934&quantity=1&size=ALL&type=STANDARD&utm_campaign=US%20-%20Shopping%20-%20Furniture&utm_content=42699934&utm_medium=paid_search&utm_source=Google&utm_term=Organizing%20and%20Storage); Retrieved on May 14, 2019.

Suspend II Media Console; <https://www.cb2.com/suspend-ii-media-console/s523915>; Retrieved on May 14, 2019.

Hooker Furniture Melange Mirrored Angle Console; [https://www.furniturecrate.com/hooker-melange-mirrored-angle-console.html?gdftrk=gdfV21650\\_a\\_7c92\\_a\\_7c8357\\_a\\_7c654170&gclid=CjwKEAiA05unBRCymrGilanF9SwSjACqDFRm1WwgePUSp65sXRCI4RkJfScYn--yCjNuB-GTt3W-FxoCQL7w\\_wcB](https://www.furniturecrate.com/hooker-melange-mirrored-angle-console.html?gdftrk=gdfV21650_a_7c92_a_7c8357_a_7c654170&gclid=CjwKEAiA05unBRCymrGilanF9SwSjACqDFRm1WwgePUSp65sXRCI4RkJfScYn--yCjNuB-GTt3W-FxoCQL7w_wcB); Retrieved on May 14, 2019.

FurnitureMaxx Besteen Contemporary Wood Dark Gray Dining Room Server; [https://www.amazon.com/dp/B07GVS1VK2/ref=cm\\_sw\\_r\\_pi\\_dp\\_U\\_x\\_evuOBbFM3298G](https://www.amazon.com/dp/B07GVS1VK2/ref=cm_sw_r_pi_dp_U_x_evuOBbFM3298G); Retrieved on May 14, 2019.

Jaydyn Media TV Stand/Credenza; [https://www.macys.com/shop/product/jaydyn-media-tv-stand-credenza?ID=2883210&CategoryID=35319#fn=FURNITURE\\_CATEGORY=Buffet%20&mp;20Sideboards&SIZE=&sp=3&spc=131&ruleId=129%7CBOOST%20ATTRIBUTE%7CBOOST%20SAVED%20SET&searchPass=matchNone&slotId=2](https://www.macys.com/shop/product/jaydyn-media-tv-stand-credenza?ID=2883210&CategoryID=35319#fn=FURNITURE_CATEGORY=Buffet%20&mp;20Sideboards&SIZE=&sp=3&spc=131&ruleId=129%7CBOOST%20ATTRIBUTE%7CBOOST%20SAVED%20SET&searchPass=matchNone&slotId=2); Retrieved on May 14, 2019.

Sideboard; <https://www.allmodern.com/furniture/pdp/sideboard-sct11710.html>; Retrieved on May 14, 2019.

Belham Living Trenton Industrial End Table; [https://www.hayneedle.com/product/belham-living-trenton-industrial-end-table-new.cfm?source=pla&kwid=OccasionalTables%20iprefer&tid=REDU113-1&adtype=pla&kw=&gclid=EAIalQobChMlvOu-6vel3wIVB8ZkCh0ZdAf-EAkYAyABEgLyMfD\\_BwE](https://www.hayneedle.com/product/belham-living-trenton-industrial-end-table-new.cfm?source=pla&kwid=OccasionalTables%20iprefer&tid=REDU113-1&adtype=pla&kw=&gclid=EAIalQobChMlvOu-6vel3wIVB8ZkCh0ZdAf-EAkYAyABEgLyMfD_BwE); Retrieved on May 15, 2019.

Belham Living Hampton Chair Side Table—Black; <https://www.hayneedle.com/product/belham-living-hampton-chair-side-table-black.cfm>; Retrieved on May 15, 2019.

International Concepts Hampton End Table; [https://www.hayneedle.com/product/internationalconceptshamptonendtable.cfm?source=pla&kwid=OccasionalTables%20level05&tid=WWI545-1&adtype=pla&kw=&gclid=EAIalQobChMIpsnoq\\_ml3wIVGNVCh348gtdEAKYliABEgLP7fD\\_BwE](https://www.hayneedle.com/product/internationalconceptshamptonendtable.cfm?source=pla&kwid=OccasionalTables%20level05&tid=WWI545-1&adtype=pla&kw=&gclid=EAIalQobChMIpsnoq_ml3wIVGNVCh348gtdEAKYliABEgLP7fD_BwE); Retrieved on May 15, 2019.

Hampton Weathered Taupe Gray Coffee Table; [https://www.homedepot.com/p/International-Concepts-Hampton-Weathered-Taupe-Gray-Coffee-Table-OT09-70C/302946359?MERCH=REC-PIPHorizontal2\\_rr\\_-204737265\\_-302946359\\_-N](https://www.homedepot.com/p/International-Concepts-Hampton-Weathered-Taupe-Gray-Coffee-Table-OT09-70C/302946359?MERCH=REC-PIPHorizontal2_rr_-204737265_-302946359_-N); Retrieved on May 15, 2019.

Convenience Concepts Oxford Rectangle Coffee Table; [https://www.hayneedle.com/product/convenience-concepts-oxford-rectangle-coffee-table.cfm?source=pla&kwid=OccasionalTables%20newskus&tid=CONV338-5&adtype=pla&kw=&gclid=EAIalQobChMIhuzv9\\_ml3wIVWx-tBh1rUAItEAKYHYABEgJ2hPD\\_BwE](https://www.hayneedle.com/product/convenience-concepts-oxford-rectangle-coffee-table.cfm?source=pla&kwid=OccasionalTables%20newskus&tid=CONV338-5&adtype=pla&kw=&gclid=EAIalQobChMIhuzv9_ml3wIVWx-tBh1rUAItEAKYHYABEgJ2hPD_BwE); Retrieved on May 15, 2019.

Belham Living Jamestown Rustic Coffee Table with Unique Driftwood Finish; <https://www.hayneedle.com/product/jamestown-rustic-coffee-table.cfm>; Retrieved on May 15, 2019.



(56)

## References Cited

## OTHER PUBLICATIONS

Pinterest; [www.pinterest.com/pin/336328451393621/](https://www.pinterest.com/pin/336328451393621/); Retrieved on Jun. 12, 2019.

Target Winham TV Stand—Threshold; [www.target.com/p/windham-tv-stand-threshold-153/-/A-54301349](https://www.target.com/p/windham-tv-stand-threshold-153/-/A-54301349); Retrieved on Jun. 12, 2019. Pinterest DIY Farmhouse Coffee Table Cabinet; [www.pinterest.com/pin/33636328450994833/](https://www.pinterest.com/pin/33636328450994833/); Retrieved on Jun. 12, 2019.

Image seen on Pinterest DIY Project; Pinterest.com; Seen approximately Aug. 1, 2017.

World Market—Metal Bexley Bar; [www.worldmarket.com/product/metal+bexley+bar.do?pp=1](https://www.worldmarket.com/product/metal+bexley+bar.do?pp=1); Retrieved on Sep. 25, 2019.

Overstock—Nova Domus Soria Modern Walnut TV Stand; [https://www.overstock.com/Home-Garden/Nova-Domus-Soria-Modern-Walnut-TV-Stand/10359356/product.html?utm\\_campaign=pin\\_button&utm\\_medium=Social&utm\\_source=Pinterest](https://www.overstock.com/Home-Garden/Nova-Domus-Soria-Modern-Walnut-TV-Stand/10359356/product.html?utm_campaign=pin_button&utm_medium=Social&utm_source=Pinterest); Retrieved on Jun. 12, 2019.

Notice of Allowance for U.S. Appl. No. 29/654,936 dated Jun. 19, 2019.

Notice of Allowance for U.S. Appl. No. 29/656,479 dated Jun. 27, 2019.

Restriction Requirement for U.S. Appl. No. 29/654,950 dated Sep. 25, 2019.

Office Action for U.S. Appl. No. 29/656,489 dated Sep. 25, 2019.

Office Action for U.S. Appl. No. 29/656,497 dated Sep. 25, 2019.

Office Action for U.S. Appl. No. 29/656,499, dated Sep. 26, 2019.

Notice of Allowance for U.S. Appl. No. 29/656,486 dated Sep. 27, 2019.

Notice of Allowance for U.S. Appl. No. 29/656,485 dated Oct. 2, 2019.

Notice of Allowance for U.S. Appl. No. 29/656,479 dated Oct. 21, 2019.

Office Action for U.S. Appl. No. 29/654,952 dated Nov. 15, 2019.

Notice of Allowance for U.S. Appl. No. 29/656,492 dated Nov. 18, 2019.

42 in. Metal and Wood Desk with Glass and Shelf Grey Wash by Walker Edison Furniture Company—Home Depot <https://www.homedepot.com/p/Walker-Edison-Furniture-Company-42-in-Metal-and-Wood-Desk-with-Glass-and-Shelf-Grey-Wash-HDM42JERGW/305309102> retrieved from the internet on Sep. 9, 2019.

Dark Walnut Wood and Glass Coffee Table by Walker Edison Furniture Company—Home Depot <https://www.homedepot.com/p/Walker-Edison-Furniture-Company-Dark-Walnut-Wood-and-Glass-Coffee-Table-HDF42JMGLDW/305308482> retrieved from the internet on Nov. 6, 2019.

“Baum TV Stand for TVs up to 58 inches” Wayfair. (Accessed Nov. 14, 2019).

“Dark Walnut 70" TV Stand” Pier1. (Accessed Nov. 14, 2019).

“Seren TV Stand for TVs up to 50 inches” Wayfair. (Accessed Nov. 14, 2019).

“Shreffler TV Stand for TVs up to 78 inches” Wayfair. (Accessed Nov. 14, 2019).

Office Action for U.S. Appl. No. 29/634,946 dated Dec. 12, 2019.

Notice of Allowance for U.S. Appl. No. 29/656,485 dated Dec. 18, 2019.

Notice of Allowance for U.S. Appl. No. 29/654,950 dated Dec. 27, 2019.

Electric Fireplaces Direct.com. <https://www.electricfireplacesdirect.com/products-accessories/tv-media-consoles/shelby-electric-fireplace-media-console-in-white-c3p18c9-2030w.html>. “Shelby Electric Fireplace Media Console in White”. Date unknown: Viewed Dec. 2019 (Year: 2019).

Pikove. <https://pikove.com/media/509962357792326443>. “Home Decor”. Feb. 2017 (Year: 2017).

Luno. <https://iamluno.com/product/kc27-record-console-new/>. “KC27 HIFI Record Console”. Date unknown: Viewed Dec. 2019 (Year: 2019).

Notice of Allowance for U.S. Appl. No. 29/656,499 dated Jan. 23, 2020.

Notice of Allowance for U.S. Appl. No. 29/656,497 dated Jan. 23, 2020.

Notice of Allowance for U.S. Appl. No. 29/656,489 dated Jan. 24, 2020.

Walker Edison Buffet 52' Console Table; <https://www.walkerredison.com/buffet-52-console-table.html>; Retrieved on Jul. 19, 2018.

Notice of Allowance for U.S. Appl. No. 29/654,952 dated Feb. 12, 2020.

Restriction Requirement for U.S. Appl. No. 29/714,849 dated Feb. 25, 2020.

Notice of Allowance for U.S. Appl. No. 29/714,849 dated Apr. 6, 2020.

Notice of Allowance for U.S. Appl. No. 29/634,946 dated Apr. 8, 2020.

Notice of Allowance for U.S. Appl. No. 29/654,952 dated Apr. 21, 2020.

Pinterest; Cabinet Furniture; wood veneer sideboard with doors—Edge Collection by Miniforms; <https://www.pinterest.com/pin/312366924137895643>; Retrieved on Aug. 9, 2018.

Edge Buffet and Cabinet; Miniforms.com; [https://www.miniforms.com/en/products/4\\_buffet-and-cabinet/105\\_edge/#f](https://www.miniforms.com/en/products/4_buffet-and-cabinet/105_edge/#f); Retrieved on Aug. 9, 2018.

Pinterest; Media Furniture Search; <https://www.pinterest.com/pin/33636328451628908/>; Retrieved on Apr. 16, 2018.

Pinterest; Furniture Search; <https://www.pinterest.com/pin/33636328453466237/>; Retrieved on Apr. 11, 2018.

Office Action for U.S. Appl. No. 29/677,738 dated Jun. 26, 2020.

Office Action for U.S. Appl. No. 29/677,723 dated Jun. 26, 2020.

“Walker Edison—W6ONOR2D Assembly Instructions.” Found online Jun. 19, 2020 at [www.walkerredison.com](http://www.walkerredison.com). Page dated Apr. 23, 2018. Retrieved from URL: <https://www.walkerredison.com/uploads/5/8/2/2/58227457/ai-w6Onor2d-%C2%AE%20version%20042318-e.pdf> (Year: 2018).

“The Urban Port Mid Century Modern Acacia Wood TV Unit.” Found online Jun. 19, 2020 at [www.amazon.com](http://www.amazon.com). Product reviewed Jun. 28, 2018. Retrieved from URL: [https://www.amazon.com/dp/B07P6QPSYJ/ref=sbl\\_dpx\\_B07LG44BN6\\_0?th=1](https://www.amazon.com/dp/B07P6QPSYJ/ref=sbl_dpx_B07LG44BN6_0?th=1) (Year: 2018).

“Simpli Home Draper Solid Wood Universal Low TV Media Stand.” Found online Jun. 19, 2020 at [www.amazon.com](http://www.amazon.com). Product reviewed Sep. 26, 2016. Retrieved from URL: [https://www.amazon.com/dp/B01AACK5FM/ref=sbl\\_dpx\\_B082WLRSMS\\_0?th=1](https://www.amazon.com/dp/B01AACK5FM/ref=sbl_dpx_B082WLRSMS_0?th=1) (Year: 2016).

“Iwell Mid-Century Modern TV Stand.” Found online Jun. 20, 2020 at [www.amazon.com](http://www.amazon.com). Product first available May 7, 2020. Retrieved from URL: <https://tinyurl.com/y9okn5lq> (Year: 2020).

“Tangkula Wooden TV Stand.” Found online Jun. 20, 2020 at [www.amazon.com](http://www.amazon.com). Product first available Jan. 13, 2020. Retrieved from URL: <https://tinyurl.com/y9h9hwwc> (Year: 2020).

“Langley Street Silvia 54-inch TV Stand.” Found online Jun. 20, 2020 at [www.amazon.com](http://www.amazon.com). Product first available Aug. 30, 2015. Retrieved from URL: [https://www.amazon.com/dp/B07BMM7PZ6/ref=sbl\\_dpxB01255EZVW\\_0](https://www.amazon.com/dp/B07BMM7PZ6/ref=sbl_dpxB01255EZVW_0) (Year: 2015).

“Walker Edison—W70JACSD Assembly Instructions.” Found online Jun. 19, 2020 at [www.walkerredison.com](http://www.walkerredison.com). Page dated Jul. 9, 2018. Retrieved from URL: <https://www.walkerredison.com/uploads/5/8/2/2/58227457/ai-w70jacsd-%C2%AE%20version%20071118-n.pdf> (Year: 2018).

“South Shore Exhibit TV Stand.” Found online Jun. 19, 2020 at [www.amazon.com](http://www.amazon.com). Product reviewed Jan. 12, 2017. Retrieved from URL: [https://www.amazon.com/dp/B01D9MW9FE/ref=sbl\\_dpxB01AACK5FM\\_0?th=1](https://www.amazon.com/dp/B01D9MW9FE/ref=sbl_dpxB01AACK5FM_0?th=1) (Year: 2017).

“Sauder Coral Cape Contemporary Wood 70-inch TV Stand.” Found online Jun. 19, 2020 at [www.amazon.com](http://www.amazon.com). Product first available Jan. 28, 2020. Retrieved from URL: [https://www.amazon.com/dp/B085VKFXJF/ref=sbl\\_dpx\\_B07LG44BN6\\_0](https://www.amazon.com/dp/B085VKFXJF/ref=sbl_dpx_B07LG44BN6_0) (Year: 2020).

“CCT Global Sourcing Inc. Pearson Solid Hardwood 60-inch TV Stand.” Found online Jun. 19, 2020 at [www.amazon.com](http://www.amazon.com). Product first available Jan. 20, 2020. Retrieved from URL: [https://www.amazon.com/dp/B0842JT1Z6/ref=sbl\\_dpx\\_B07LG44BN6\\_0](https://www.amazon.com/dp/B0842JT1Z6/ref=sbl_dpx_B07LG44BN6_0) (Year: 2020).

Notice of Allowance for U.S. Appl. No. 29/677,722 dated Jul. 1, 2020.

“Walker Edison—W58BMHPAS Assembly Instructions.” Found online Jun. 19, 2020 at [www.walkerredison.com](http://www.walkerredison.com). Page dated Apr. 23,



(56)

## References Cited

## OTHER PUBLICATIONS

2018. Retrieved from URL: [https://www.walkerredison.com/uploads/5/8/2/2/58227457/ai-w58bnnhpas-%C2%AE version 042318 -e.pdf](https://www.walkerredison.com/uploads/5/8/2/2/58227457/ai-w58bnnhpas-%C2%AE%20version%20042318-e.pdf) (Year: 2018).

“Mid Century Modern TV Stand.” Found online Jun. 20, 2020 at [www.amazon.com](http://www.amazon.com). Product first available Jun. 16, 2020. Retrieved from URL: <https://tinyurl.com/y7qolcv7> (Year: 2020).

“Pemberly Row Modern Mid Century Entertainment TV Stand.” Found online Jun. 20, 2020 at [www.amazon.com](http://www.amazon.com). Product first available May 25, 2018. Retrieved from URL: <https://tinyurl.com/y9affau7> (Year: 2018).

Notice of Allowance for U.S. Appl. No. 29/677,724 dated Jul. 7, 2020.

“Walker Edison—W60S014D Assembly Instructions.” Found online Jun. 19, 2020 at [www.walkerredison.com](http://www.walkerredison.com). Page dated May 8, 2018. Retrieved from URL: [https://www.walkerredison.com/uploads/5/8/2/2/58227457/ai-w60soi4d-%C2%AE version 050818 n.pdf](https://www.walkerredison.com/uploads/5/8/2/2/58227457/ai-w60soi4d-%C2%AE%20version%20050818-n.pdf) (Year: 2018).

“Sauder Boulevard Cafe Credenza.” Found online Jun. 19, 2020 at [www.amazon.com](http://www.amazon.com). Product first available Aug. 23, 2018. Retrieved from URL: [https://www.amazon.com/Sauder-420649-Boulevard-Credenza-Vintage/dp/B07GSJ4MG1/ref=psdc\\_14109851\\_t1B07G62YLVT](https://www.amazon.com/Sauder-420649-Boulevard-Credenza-Vintage/dp/B07GSJ4MG1/ref=psdc_14109851_t1B07G62YLVT) (Year: 2018).

“Martin Furniture Eclectic Harmon Four Door Console.” Found online Jun. 19, 2020 at [www.amazon.com](http://www.amazon.com). Product first available Oct. 30, 2017. Retrieved from URL: [https://www.amazon.com/dp/B076VVVYRPR/ref=sbl\\_dp\\_x\\_B07G62YLVT\\_0](https://www.amazon.com/dp/B076VVVYRPR/ref=sbl_dp_x_B07G62YLVT_0) (Year: 2017).

“Industrial Iron Mesh Sideboard Media Cabinet.” Found online Jun. 19, 2020 at [www.amazon.com](http://www.amazon.com). Product first available Jul. 20, 2015. Retrieved from URL: [https://www.amazon.com/dp/B01255EZVW/ref=sbl\\_dp\\_x\\_B07G62YLVT\\_0](https://www.amazon.com/dp/B01255EZVW/ref=sbl_dp_x_B07G62YLVT_0) (Year: 2015).

Safavieh Furniture; <http://web.archive.org/web/20130301232929/http://safavieh.com/furniture/categories/bookcases?pg=all>; Retrieved online on Aug. 5, 2020.

Safavieh Furniture; <http://web.archive.org/web/20140713025018/http://safavieh.com/furniture/american-home/bookcases/amh6525a>; Retrieved online on Aug. 5, 2020.

Amarah Mid Century Modern Wood TV Stand by Christopher Knight Home; <https://web.archive.org/web/20181102021725/https://www.overstock.ca/Home-Garden/Amarah-Mid-century-Modern-Wood-TV-Stand-by-Christopher-Knight-Home/18108793/product.html>; Retrieved online on Aug. 5, 2020.

Gemini Wood Contemporary TV Stand; <https://web.archive.org/web/20160423180238/https://www.target.com/p/gemini-wood-contemporary-tv-stand-walnut-white-66-baxton-studio/-/A-50256043>; Retrieved online on Aug. 5, 2020.

Article Seno walnut media unit; <http://web.archive.org/web/20170610131805/https://www.article.com/product/1635/seno-walnut-63-media-unit>; Retrieved online on Aug. 5, 2020.

Instagram post—Article Seno walnut media unit; <https://www.instagram.com/p/BhcCAZIH8-q/>; Retrieved on Aug. 5, 2020.

Convenience Concepts Designs2Go Oslo TV Stand; <https://www.amazon.ca/Convenience-Concepts-Designs2Go-Stand-White/dp/B011RACHQ6/?th=1>; Retrieved online on Aug. 5, 2020.

Houzz\_Rowan\_Mid-Century Modern Two-Toned TV Stand; <https://www.houzz.com/products/rowan-mid-century-modern-two-toned-tv-stand-white-oak-prvw-vr-74489612>; Retrieved online on Aug. 21, 2020.

Focus On Furniture, Lowline TV Units; <https://web.archive.org/web/20170218071314/https://www.focusonfurniture.com.au/living-room/lowline-tv-units/>; Retrieved on Aug. 21, 2020.

Office Action for U.S. Appl. No. 29/654,930, dated Aug. 21, 2020. Calie TV Stand for TVs up to 48 inches with Electric Fireplace Included; Wayfair.com; <https://www.wayfair.com/furniture/pdp/real-flame-calie-tv-stand-for-tvs-up-to-48-inches-with-electric-fireplace-included-jfp1647.html>; Retrieved on Jan. 10, 2018.

Restriction Requirement for U.S. Appl. No. 29/698,919, dated Aug. 27, 2020.

Office Action for U.S. Appl. No. 29/677,755, dated Aug. 27, 2020.

Foundry Arsenault End Table, [www.wayfair.com](http://www.wayfair.com) [online]. Published on or before Aug. 15, 2020, [retrieved on Aug. 15, 2020], Retrieved from the Internet: <URL:<https://www.wayfair.ca/furniture/pdp/foundry-select-arsenault-4-legs-end-table-c003160002.html?piid=1664365403>> (Year: 2020).

Office Action for U.S. Appl. No. 29/698,928, dated Aug. 28, 2020. Notice of Allowance for U.S. Appl. No. 29/698,940, dated Aug. 28, 2020.

Rustic Farmhouse Corner TV Stand With Barn Doors, Little Rustic Shop, site visited Aug. 24, 2020, available online at <https://littlerusticshop.com/collections/frontpage/products/rustic-farmhouse-corner-tv-stand-with-barn-doors> (Year: 2020).

Office Action for U.S. Appl. No. 29/698,947, dated Aug. 31, 2020. White Eliza TV Stand With Fireplace Insert, Owens Home Furnishings, site visited Aug. 25, 2020, available online at <https://www.owensfurniture.com/eliza-white-barn-door-tv-stand-70/> (Year: 2020).

Office Action for U.S. Appl. No. 29/698,942, dated Aug. 31, 2020. Office Action for U.S. Appl. No. 29/677,761, dated Sep. 1, 2020.

Foundry Select Arsenault Coffee Table, [www.wayfair.ca](http://www.wayfair.ca) [online]. Published on or before Aug. 11, 2020, [retrieved on Aug. 11, 2020], Retrieved from the Internet: <URL:<https://www.wayfair.ca/furniture/pdp/foundry-select-arsenault-coffee-table-c003159996.html>> (Year: 2020).

Notice of Allowance for U.S. Appl. No. 29/699,063, dated Sep. 2, 2020.

Notice of Allowance for U.S. Appl. No. 29/699,071, dated Sep. 4, 2020.

Notice of Allowance for U.S. Appl. No. 29/699,066, dated Sep. 11, 2020.

Notice of Allowance for U.S. Appl. No. 29/677,723, dated Sep. 15, 2020.

Notice of Allowance for U.S. Appl. No. 29/677,738, dated Sep. 15, 2020.

Notice of Allowance for U.S. Appl. No. 29/698,942, dated Sep. 15, 2020.

Office Action for U.S. Appl. No. 29/698,924, dated Sep. 16, 2020. Notice of Allowance for U.S. Appl. No. 29/699,073, dated Sep. 16, 2020.

Corrected Notice of Allowance for U.S. Appl. No. 29/698,942, dated Sep. 23, 2020.

Notice of Allowance for U.S. Appl. No. 29/677,723, dated Sep. 29, 2020.

Notice of Allowance for U.S. Appl. No. 29/677,738, dated Sep. 29, 2020.

Notice of Allowance for U.S. Appl. No. 29/720,732; dated Sep. 29, 2020.

Notice of Allowance for U.S. Appl. No. 29/721,435, dated Sep. 29, 2020.

Notice of Allowance for U.S. Appl. No. 29/677,724, dated Sep. 30, 2020.

Notice of Allowance for U.S. Appl. No. 29/699,071, dated Sep. 30, 2020.

Notice of Allowance for U.S. Appl. No. 29/720,923, dated Sep. 30, 2020.

Office Action for U.S. Appl. No. 29/699,078, dated Oct. 6, 2020.

“We Furniture AZ40SWICTWMDC Coffee Table.” Found online Sep. 30, 2020 at [www.amazon.com](http://www.amazon.com). Product first available Jan. 23, 2019 Retrieved from URL: [https://www.amazon.com/-/es/Furniture-AZ40SWICTWMDC-centro-Madera-Vidrio/dp/B07N282396/ref=psdc\\_3733631\\_J2\\_B07CYML1LF](https://www.amazon.com/-/es/Furniture-AZ40SWICTWMDC-centro-Madera-Vidrio/dp/B07N282396/ref=psdc_3733631_J2_B07CYML1LF) (Year: 2019).

“Vasagle Glatal Glass Coffee Table.” Found online Sep. 30, 2020 at [www.amazon.com](http://www.amazon.com). Product first available May 1, 2020. Retrieved from URL: <https://tinyurl.com/yxvuv2rf> (Year: 2020).

“Henn and Hart Coffee Table.” Found online Sep. 30, 2020 at [www.amazon.com](http://www.amazon.com). Product first available Jan. 20, 2019. Retrieved from URL: [https://www.amazon.com/-/es/Henn-Hart-talla-%C3%BA-nica-color/dp/B07N8RRPT5/ref=psdc\\_3733631\\_t5\\_B07CYML1LF](https://www.amazon.com/-/es/Henn-Hart-talla-%C3%BA-nica-color/dp/B07N8RRPT5/ref=psdc_3733631_t5_B07CYML1LF) (Year: 2019).

Notice of Allowance for U.S. Appl. No. 29/677,755, dated Oct. 27, 2020.

Notice of Allowance for U.S. Appl. No. 29/720,923, dated Oct. 28, 2020.



(56)

## References Cited

## OTHER PUBLICATIONS

Lorraine TV Stand for TVs up to 60" Retrieved online Nov. 3, 2020; from URL: <https://www.wayfair.com/furniture/pdp/three-posts-lorraine-tv-stand-for-tvs-up-to-60-w001527559.html>.

Notice of Allowance for U.S. Appl. No. 29/698,942, dated Nov. 3, 2020.

Notice of Allowance for U.S. Appl. No. 29/699,073, dated Nov. 3, 2020.

Notice of Allowance for U.S. Appl. No. 29/721,435, dated Nov. 3, 2020.

"Alera Angled Doors Oak Wood Black Sideboard" <https://www.decorpad.com/bookmark.htm?bookmarkId=69182> (Retrieved Nov. 12, 2020).

"Linus Base Cabinet w/Double Angled Doors by HABA, 460499\*" <https://gresscoltd.com/linus-base-cabinet-w-double-angled-doors-by-haba-460499.html> (Retrieved Nov. 12, 2020).

"Solid Acacia Wood Canyon Ridge Three Drawer Media TV Console ith Metal Base" <https://www.hootjudkins.com/solid-acacia-wood-canyon-ridge-three-drawer-media-tv-console-with-metal-base> (Retrieved Nov. 12, 2020).

Office Action for U.S. Appl. No. 29/756,291, dated Nov. 23, 2020. Barn Door Console, @sarahashleyallen on Instagram, Dec. 26, 2016, site visited Nov. 18, 2020, available online at <https://www.instagram.com/p/BOFH8jqgZjK/?taken-by=sarahashleyallen> (Year: 2016).

DIY Barn Door Hardware, Ana White, Oct. 17, 2018, site visited Nov. 18, 2020, available online at <https://www.ana-white.com/woodworking-projects/diy-barn-door-hardware-washers> (Year: 2018). Office Action for U.S. Appl. No. 29/698,919, dated Nov. 24, 2020. DIY Sliding Barn Door Console, Jaime Costiglio, Jan. 1, 2019, site visited Nov. 18, 2020, available online at <https://jaimecostiglio.com/diy-sliding-barn-door-console-free-plans/> (Year: 2019).

Notice of Allowance for U.S. Appl. No. 29/654,930, dated Dec. 10, 2020.

Notice of Allowance for U.S. Appl. No. 29/698,947, dated Dec. 10, 2020.

Notice of Allowance for U.S. Appl. No. 29/698,928, dated Dec. 11, 2020.

Notice of Allowance for U.S. Appl. No. 29/698,924, dated Dec. 18, 2020.

Notice of Allowance for U.S. Appl. No. 29/677,761, dated Dec. 22, 2020.

Notice of Allowance for U.S. Appl. No. 29/756,763, dated Dec. 22, 2020.

Notice of Allowance for U.S. Appl. No. 29/720,732; dated Jan. 25, 2021.

Notice of Allowance for U.S. Appl. No. 29/699,078, dated Jan. 28, 2021.

Studio 350 Wood Cabinet; retrieved on Mar. 11, 2021; <https://www.overstock.com/Home-Garden/Studio-350-Wood-Cabinet-30-inches-wide-34-inches-high/17357264/product.html>.

Amazon Brand—Rivet Mid-Century Modern Checkerboard Reclaimed Elm Buffet Sideboard Credenza Cabinet; retrieved on Mar. 11, 2021; [https://www.amazon.com/Rivet-Mid-Century-Checkerboard-Reclaimed-Cabinet/dp/B075Z8628K/ref=h\\_npb\\_a2a\\_sims\\_1?\\_encoding=UTF8&pd\\_rd\\_i=B075Z8628K&pd\\_rd\\_r=a9f26748-f7ef-11e8-bd88-f19ea5af337e&pd\\_rd\\_w=LLe5w&pd\\_rd\\_wg=SDrAx&pf\\_rd\\_i=desktop-dp-sims&pf\\_rd\\_m=ATVPDKIKX0DER&pf\\_rd\\_p=31feaa4d-b746-4950-83b6-1e38b78bee56&pf\\_rd\\_r=9MFY1C4VSTB9H8PGVEGJ&pf\\_rd\\_s=desktop-dp-sims&pf\\_rd\\_t=40701&pvc=1&refRID=9MFY1C4VSTB9H8PGVEGJ](https://www.amazon.com/Rivet-Mid-Century-Checkerboard-Reclaimed-Cabinet/dp/B075Z8628K/ref=h_npb_a2a_sims_1?_encoding=UTF8&pd_rd_i=B075Z8628K&pd_rd_r=a9f26748-f7ef-11e8-bd88-f19ea5af337e&pd_rd_w=LLe5w&pd_rd_wg=SDrAx&pf_rd_i=desktop-dp-sims&pf_rd_m=ATVPDKIKX0DER&pf_rd_p=31feaa4d-b746-4950-83b6-1e38b78bee56&pf_rd_r=9MFY1C4VSTB9H8PGVEGJ&pf_rd_s=desktop-dp-sims&pf_rd_t=40701&pvc=1&refRID=9MFY1C4VSTB9H8PGVEGJ).

Notice of Allowance for U.S. Appl. No. 29/720,093, dated Mar. 12, 2021.

1 stopbedrooms, <https://www.1stopbedrooms.com/ramona-autumn-bronze-media-console-electric-fireplace-with-acrylic-ice-xhd-firebox>. "Ramona Autumn Bronze Media Console Electric Fireplace with Acrylic Ice Xhd Firebox". Date Unknown: Viewed Feb. 2021 (Year: 2021).

Office Action for U.S. Appl. No. 29/756,291, dated Mar. 18, 2021.

"Pemberly Row 32-inch Farmhouse Sliding Barn Door Wood Accent Chest." Found online Mar. 4, 2021 at [www.amazon.com](http://www.amazon.com). Product first available Dec. 28, 2018. Retrieved from URL: <https://www.amazon.com/Pemberly-Row-Sliding-Console-Barnwood/dp/B07MQGF51Y> (Year: 2018).

"Walker Edison Abbey Modern Farmhouse Sliding X Barn Door Accent Console." Found online Mar. 4, 2021 at [www.amazon.com](http://www.amazon.com). Customer question answered Apr. 15, 2019. Retrieved from URL: <https://tinyurl.com/36keempk> (Year: 2019).

Notice of Allowance for U.S. Appl. No. 29/698,919; dated Mar. 30, 2021.

Bridgeport by Hopewood; Found online on Mar. 29, 2021 at <https://hubbingtons.com/product-category/bridgeport-by-hopewood/>.

Bridgeport Furniture; Found online on Mar. 29, 2021 at [www.flemingtondepartmentstore.com/all/bridgeport/brand-collection.aspx](http://www.flemingtondepartmentstore.com/all/bridgeport/brand-collection.aspx). Bridgeport 3-Door Server; Found online on Mar. 29, 2021; Found online at [https://www.belfortfurniture.com/\(X\(1\)\)/item/dining-bridgeport-3-door-server/307396660](https://www.belfortfurniture.com/(X(1))/item/dining-bridgeport-3-door-server/307396660).

Office Action for U.S. Appl. No. 29/756,763; dated Apr. 12, 2021. Gray Barn Wind Gap Sliding Barn Door TV Stand Console, overstock.com, review date with photo from Apr. 8, 2019 & Jul. 10, 2019, <https://www.overstock.com/Home-Garden/The-Gray-Barn-Wind-Gap-Sliding-Barn-Door-TV-Stand-Console/25490525/product.html> (Year: 2019).

Notice of Allowance for U.S. Appl. No. 29/743,416; dated Apr. 21, 2021.

Console, Item# W58SGRD Assembly Instructions; found online Jul. 2, 2020; retrieved on May 3, 2021, (online); [https://www.overstock.com/downloads/pdf/1219684877\\_1dbe384b-588a-3260-a4d9-6d3bac52ba4a.pdf](https://www.overstock.com/downloads/pdf/1219684877_1dbe384b-588a-3260-a4d9-6d3bac52ba4a.pdf).

Renegar 2 Door Accent Cabinet; Wayfair.com; found online Apr. 21, 2021; retrieved May 3, 2021 (online); <https://www.wayfair.com/furniture/pdp/gracie-oaks-renegar-2-door-accent-cabinet-w001524010.html>.

Guadalupe TV Stand; Wayfair.com; found online Apr. 21, 2021; retrieved May 4, 2021 (online); <https://www.wayfair.com/furniture/pdp/guadalupe-tv-stand-for-tvs-up-to-65-w003233469.html?piid=848017954>.

Corsham TV Stand; Wayfair.com; found online Apr. 21, 2021; retrieved May 4, 2021 (online); <https://www.wayfair.com/furniture/pdp/rosalind-wheeler-corsham-tv-stand-for-tvs-up-to-65-w003211663.html>.

Everitt TV Stand; Wayfair.com; found online Apr. 21, 2021; retrieved May 4, 2021 (online); <https://www.wayfair.com/furniture/pdp/gracie-oaks-everitt-tv-stand-for-tvs-up-to-65-w001524186.html?piid=1788638279>.

Guadalupe TV Stand with Electric Fireplace; Wayfair.com; found online Apr. 21, 2021; retrieved May 4, 2021 (online); <https://www.wayfair.com/furniture/pdp/guadalupe-tv-stand-for-tvs-up-to-65-with-electric-fireplace-included-w003233344.html>.

Brianna TV Stand; Wayfair.com; found online Apr. 21, 2021; retrieved May 4, 2021 (online); <https://www.wayfair.com/furniture/pdp/coastal-farmhouse-brianna-tv-stand-for-tvs-up-to-80-w004028674.html>.

Fryar TV Stand; Wayfair.com; found online Apr. 21, 2021; retrieved May 4, 2021 (online); <https://www.wayfair.com/furniture/pdp/gracie-oaks-fryar-tv-stand-for-tvs-up-to-75-w001713808.html>.

Polegate TV Stand; Wayfair.com; found online Apr. 21, 2021; retrieved May 4, 2021 (online); <https://www.wayfair.com/furniture/pdp/three-posts-teen-polegate-tv-stand-for-tvs-up-to-70-w000171190.html>.

Brawley TV Stand; Wayfair.com; found online Apr. 21, 2021; retrieved May 4, 2021 (online); <https://www.wayfair.com/furniture/pdp/17-stories-brawley-tv-stand-for-tvs-up-to-65-w004231614.html>.

Lorraine TV Stand; Wayfair.com; found online Apr. 21, 2021; retrieved May 4, 2021 (online); <https://www.wayfair.com/furniture/pdp/three-posts-lorraine-tv-stand-for-tvs-up-to-60-w001527559.html>.

Skofte TV Stand; Wayfair.com; found online Apr. 21, 2021; retrieved May 4, 2021 (online); <https://www.wayfair.com/furniture/pdp/gracie-oaks-skofte-tv-stand-for-tvs-up-to-60-w001487399.html>.



(56)

## References Cited

## OTHER PUBLICATIONS

Miah TV Stand; Wayfair.com; found online Apr. 21, 2021; retrieved May 4, 2021 (online); <https://www.wayfair.com/furniture/pdp/rosalind-wheeler-miah-tv-stand-for-tvs-up-to-60-w002831147.html>.

Grendel TV Stand; Wayfair.com; found online Apr. 21, 2021; retrieved May 4, 2021 (online); <https://www.wayfair.com/furniture/pdp/gracie-oaks-grendel-tv-stand-for-tvs-up-to-65-w003337326.html>.

Heger TV Stand; Wayfair.com; found online Apr. 21, 2021; retrieved May 4, 2021 (online); <https://www.wayfair.com/furniture/pdp/gracie-oaks-heger-tv-stand-for-tvs-up-to-65-w002101430.html>.

Erwine TV Stand; Wayfair.com; found online Apr. 21, 2021; retrieved May 4, 2021 (online); [https://www.wayfair.com/furniture/pdp/gracie-oaks-erwine-tv-stand-for-tvs-up-to-65-w004339905.html?categoryId=1868409&placement=3&slot=4&sponsoredid=0ca938f17db89643b10f637f9b2b9c0dba95bcc09d09607add3721a8a0b5e2dc&\\_txid=1%2FcmXF%2B1T41hnharBpMJAg%3D%3D&isB2b=0&auctionId=f9be48b1-0bcd-4aaf-b285-dbb3ea880db5](https://www.wayfair.com/furniture/pdp/gracie-oaks-erwine-tv-stand-for-tvs-up-to-65-w004339905.html?categoryId=1868409&placement=3&slot=4&sponsoredid=0ca938f17db89643b10f637f9b2b9c0dba95bcc09d09607add3721a8a0b5e2dc&_txid=1%2FcmXF%2B1T41hnharBpMJAg%3D%3D&isB2b=0&auctionId=f9be48b1-0bcd-4aaf-b285-dbb3ea880db5).

Sliding Barn Door Television Stand; Amazon.com; found online Apr. 21, 2021; retrieved May 4, 2021 (online); [https://www.amazon.com/Home-Accent-Furnishings-Sliding-Television/dp/B07DKX44QQ/ref=sr\\_1\\_6?dchild=1&keywords=sliding+barn+door+tv+stand&qid=1603301187&sr=8-6](https://www.amazon.com/Home-Accent-Furnishings-Sliding-Television/dp/B07DKX44QQ/ref=sr_1_6?dchild=1&keywords=sliding+barn+door+tv+stand&qid=1603301187&sr=8-6).

Farmhouse Sliding Barn Door TV Stand; Amazon.com; found online Apr. 21, 2021; retrieved May 4, 2021 (online); [https://www.amazon.com/Rainbow-Sophia-Forest-Wooden-Sliding/dp/B081VWRS1K/ref=sr\\_1\\_2?dchild=1&keywords=sliding+barn+door+tv+stand&qid=1603301187&sr=8-2](https://www.amazon.com/Rainbow-Sophia-Forest-Wooden-Sliding/dp/B081VWRS1K/ref=sr_1_2?dchild=1&keywords=sliding+barn+door+tv+stand&qid=1603301187&sr=8-2).

GHQME Sliding Barn Door TV Stand; Amazon.com; found online Apr. 21, 2021; retrieved May 4, 2021 (online); [https://www.amazon.com/GHQME-Table%EF%BC%8CWood-Universal-Stand%EF%BC%8CLiving-Entertainment/dp/B083BJR9YF/ref=sr\\_1\\_1\\_sspa?dchild=1&keywords=sliding+barn+door+tv+stand&qid=1603301187&sr=8-1-spons&psc=1&spLa=ZW5jenlwdGVkUXVhbGlmaWVyPUExVTAYT1hNVDk1VVRJmVuY3J5cHRIZElkPUEwMjg5MjgwMVVKTE5HRkdKR0UyTCZlbnNyeXB0ZWRBZEIkPUEwNzQ5NzU4M1BEN0wyMFpMNUgxQSZ3aWRnZXROYW1IPXNwX2F0ZiZhY3Rpb249Y2xpY2tSZWRpcmVjdCZkb05vdExvZ0NsaWNRpXRydWU=](https://www.amazon.com/GHQME-Table%EF%BC%8CWood-Universal-Stand%EF%BC%8CLiving-Entertainment/dp/B083BJR9YF/ref=sr_1_1_sspa?dchild=1&keywords=sliding+barn+door+tv+stand&qid=1603301187&sr=8-1-spons&psc=1&spLa=ZW5jenlwdGVkUXVhbGlmaWVyPUExVTAYT1hNVDk1VVRJmVuY3J5cHRIZElkPUEwMjg5MjgwMVVKTE5HRkdKR0UyTCZlbnNyeXB0ZWRBZEIkPUEwNzQ5NzU4M1BEN0wyMFpMNUgxQSZ3aWRnZXROYW1IPXNwX2F0ZiZhY3Rpb249Y2xpY2tSZWRpcmVjdCZkb05vdExvZ0NsaWNRpXRydWU=).

Pamari Wrangler Sliding Barn Door TV Stand; Amazon.com; found online Apr. 21, 2021; retrieved May 4, 2021 (online); [https://www.amazon.com/dp/B07KSMQH4D/ref=dp\\_cr\\_wdg\\_tit\\_nw\\_mr](https://www.amazon.com/dp/B07KSMQH4D/ref=dp_cr_wdg_tit_nw_mr).

The Gray Barn Berkley TV Stand; Overstock.com; found online Apr. 21, 2021; retrieved May 4, 2021 (online); <https://www.overstock.com/Home-Garden/Convenience-Concepts-Blake-Barn-Door-TV-Stand/28387177/product.html?recalg=954%2C873%2C839&recidx=2&recset=0a8617dc-0d40-4dcf-b57f-7220ec2436da&refccid=2NUDSESYZPUIPKBLPZR6M7VUE>.

The Gray Barn Ansley Media Console; Overstock.com; found online Apr. 21, 2021; retrieved May 4, 2021 (online); <https://www.overstock.com/Home-Garden/Entertainment-Centers/2029/subcat.html?featuredproduct=31934591>.

Barn Door Rustic TV Stand; Overstock.com; found online Apr. 21, 2021; retrieved May 4, 2021 (online); <https://www.overstock.com/Home-Garden/TV-Stand-for-TVs-up-to-60-inches/30841483/product.html?TID=PDP%3ASimilarItemsCarousel%3Aclick&recalg=954%2C930&recidx=0&recset=0f33724c-aeb3-4523-8c14-9d784eb7cf87&refccid=GRRWJGIVNYNLCD2OLN3SPQ>.

Ktaxon 58' Farmhouse TV Stand; Walmart.com; found online Apr. 21, 2021; retrieved May 4, 2021 (online); <https://www.walmart.com/ip/Ktaxon-58-Farmhouse-TV-Stand-TVs-60-Sliding-Wood-Barn-Door-Media-Console-Storage-Cabinet-Rustic-Gray-Wash-Entertainment-Center-Living-Room/671965194>.

Sekey Home Sliding Barn Door TV Stand; Walmart.com; found online Apr. 21, 2021; retrieved May 4, 2021 (online); <https://www.walmart.com/ip/Sekey-Home-Sliding-Barn-Door-TV-Stand-Entertainment-Center-TV-Console-for-58-for-Flat-Screen-TV-s-Up-to-65-Light-Oak/458659151>.

Wrangler Sliding Barn Door TV Stand; Walmart.com; found online Apr. 21, 2021; retrieved May 4, 2021 (online); <https://www.walmart.com/ip/pamari-tc54-6127-tpg03-wrangler-sliding-barn-door-tv-stand-off-white/232902955>.

UBesGoo Wooden TV Stand; Walmart.com; found online Apr. 21, 2021; retrieved May 5, 2021 (online); <https://www.walmart.com/ip/UBesGoo-Wooden-58-TV-Stand-for-TVs-up-to-60-with-Sliding-Wood-Barn-Door-Media-Console-Storage-Cabinet-for-Living-Room-Bedroom-Rustic-Gray-Wash/152098747>.

Walker Edison White Oak Sliding Barn Door Media Console; Walmart.com; found online Apr. 21, 2021; retrieved May 5, 2021 (online); [https://www.walmart.com/ip/58-inch-Sliding-Barn-Door-TV-Stand-Media-Console-in-White-Oak/207240611?wpa\\_bd=&wpa\\_pg\\_seller\\_id=203317B21FE947819EB684DAE150ECA5&wpa\\_ref\\_id=wpaqs:d\\_0rL\\_oQQqieprA9uyaaVHrAzrOtC-Wq7We-HPBeJZ4x2Sw4Gpn\\_0lh25qru9K6ySqAW-QcvE3KfQy194-h8-MvmpzeSFJim72C-yCvH2OltMjV0nstG23HBInTx63HkquiB05hGWHy8kVH0xlaFLkbyfv2FAVWjeQNq2bW\\_hy9-0QU8KSQFz6Qk0VVSI45ek5NrhChuAbB5luyXKyBnz7mBFX5QNg0iDbJF\\_agFSWAa0WyLemcKJRpUROh3rkbe2KNnr4XI\\_but\\_fHW0gMo6IGSyxVrdkdPvJOExzLt4pA&wpa\\_tag=&wpa\\_aux\\_info=&wpa\\_pos=1 &wpa\\_plmt=1145x1145\\_T-C-IG\\_TI\\_1-2\\_HL-INGRID-GRID-NY&wpa\\_aduid=5766f3ab-d7ae-4319-80dd-6f96862cee51&wpa\\_pg=search&wpa\\_pg\\_id=sliding%20barn%20door%20tv%20stand&wpa\\_st=sliding%2Bbarn%2Bdoor%2Btv%2Bstand&wpa\\_tax=4044\\_103150\\_635499\\_2546222&wpa\\_bucket=bkt\\_](https://www.walmart.com/ip/58-inch-Sliding-Barn-Door-TV-Stand-Media-Console-in-White-Oak/207240611?wpa_bd=&wpa_pg_seller_id=203317B21FE947819EB684DAE150ECA5&wpa_ref_id=wpaqs:d_0rL_oQQqieprA9uyaaVHrAzrOtC-Wq7We-HPBeJZ4x2Sw4Gpn_0lh25qru9K6ySqAW-QcvE3KfQy194-h8-MvmpzeSFJim72C-yCvH2OltMjV0nstG23HBInTx63HkquiB05hGWHy8kVH0xlaFLkbyfv2FAVWjeQNq2bW_hy9-0QU8KSQFz6Qk0VVSI45ek5NrhChuAbB5luyXKyBnz7mBFX5QNg0iDbJF_agFSWAa0WyLemcKJRpUROh3rkbe2KNnr4XI_but_fHW0gMo6IGSyxVrdkdPvJOExzLt4pA&wpa_tag=&wpa_aux_info=&wpa_pos=1 &wpa_plmt=1145x1145_T-C-IG_TI_1-2_HL-INGRID-GRID-NY&wpa_aduid=5766f3ab-d7ae-4319-80dd-6f96862cee51&wpa_pg=search&wpa_pg_id=sliding%20barn%20door%20tv%20stand&wpa_st=sliding%2Bbarn%2Bdoor%2Btv%2Bstand&wpa_tax=4044_103150_635499_2546222&wpa_bucket=bkt_).

Albright TV Stand; Wayfair.com; found online Apr. 21, 2021; retrieved May 3, 2021 (online); <https://www.wayfair.com/furniture/pdp/three-posts-albright-tv-stand-w003419693.html?placement=1>.

Chantell TV Stand; Wayfair.com; found online Apr. 21, 2021; retrieved May 5, 2021 (online); <https://www.wayfair.com/furniture/pdp/latitude-run-chantell-tv-stand-for-tvs-up-to-65-lrun1015.html>.

Gainesboro TV Stand; Wayfair.com; found online Apr. 21, 2021; retrieved May 5, 2021 (online); <https://www.wayfair.com/furniture/pdp/winston-porter-gainesboro-tv-stand-for-tvs-up-to-65-w003895133.html>.

Albritton TV Stand; Wayfair.com; found online Apr. 21, 2021; retrieved May 5, 2021 (online); <https://www.wayfair.com/furniture/pdp/three-posts-albritton-tv-stand-for-tvs-up-to-65-w003404447.html?placement=1>.

Chabelli TV Stand; Wayfair.com; found online Apr. 21, 2021; retrieved May 5, 2021 (online); [https://www.wayfair.com/furniture/pdp/latitude-run-chabelli-tv-stand-for-tvs-up-to-65-w004029827.html?categoryId=1868409&placement=3&slot=5&sponsoredid=bb92fbde3cc952ed7e2c82697812cb88232c512191dad5893e80ad17d6adb05f&\\_txid=1%2FcmXF%2B1T41hnharBpMJAg%3D%3D&isB2b=0&auctionId=f9be48b1-0bcd-4aaf-b285-dbb3ea880db5](https://www.wayfair.com/furniture/pdp/latitude-run-chabelli-tv-stand-for-tvs-up-to-65-w004029827.html?categoryId=1868409&placement=3&slot=5&sponsoredid=bb92fbde3cc952ed7e2c82697812cb88232c512191dad5893e80ad17d6adb05f&_txid=1%2FcmXF%2B1T41hnharBpMJAg%3D%3D&isB2b=0&auctionId=f9be48b1-0bcd-4aaf-b285-dbb3ea880db5).

Gaither TV Stand; Wayfair.com; found online Apr. 21, 2021; retrieved May 5, 2021 (online); <https://www.wayfair.com/furniture/pdp/alcott-hill-gaither-tv-stand-for-tvs-up-to-65-with-fireplace-included-acot3821.html>.

Plazonja TV Stand; Wayfair.com; found online Apr. 21, 2021; retrieved May 5, 2021 (online); <https://www.wayfair.com/furniture/pdp/winston-porter-plazonja-tv-stand-for-tvs-up-to-75-w002590978.html>.

Alisée Console; Wayfair.com; found online Apr. 21, 2021; retrieved May 5, 2021 (online); <https://www.wayfair.com/furniture/pdp/ebern-designs-alisee-tv-stand-for-tvs-up-to-78-w002981803.html>.

Bolderberg Console; Wayfair.com; found online Apr. 21, 2021; retrieved May 5, 2021 (online); <https://www.wayfair.com/furniture/pdp/winston-porter-bolderberg-tv-stand-for-tvs-up-to-78-w003404204.html?placement=1>.

Dunsmuir TV Stand; Wayfair.com; found online Apr. 21, 2021; retrieved May 5, 2021 (online); <https://www.wayfair.com/furniture/pdp/andover-mills-dunsmuir-tv-stand-for-tvs-up-to-78-w002122263.html>.

Annaliece TV Stand; Wayfair.com; found online Apr. 21, 2021; retrieved May 5, 2021 (online); <https://www.wayfair.com/furniture/pdp/red-barrel-studio-annaliece-tv-stand-for-tvs-up-to-78-w004115724.html>.



(56)

## References Cited

## OTHER PUBLICATIONS

Straughn TV Stand; Wayfair.com; found online Apr. 21, 2021; retrieved May 5, 2021 (online); <https://www.wayfair.com/furniture/pdp/gracie-oaks-straughn-tv-stand-for-tvs-up-to-78-w004455598.html>.

Strausstown TV Stand; Wayfair.com; found online Apr. 21, 2021; retrieved May 5, 2021 (online); <https://www.wayfair.com/furniture/pdp/gracie-oaks-strausstown-tv-stand-for-tvs-up-to-78-w004458013.html>.

Adcock TV Stand; Wayfair.com; found online Apr. 21, 2021; retrieved May 5, 2021 (online); <https://www.wayfair.com/furniture/pdp/andover-mills-adcock-tv-stand-for-tvs-up-to-78-w004124702.html?placement=7>.

Gaudreau TV Stand; Wayfair.com; found online Apr. 21, 2021; retrieved May 5, 2021 (online); <https://www.wayfair.com/furniture/pdp/red-barrel-studio-gaudreau-solid-wood-tv-stand-for-tvs-up-to-78-qdy2069.html>.

Himrod TV Stand; Wayfair.com; found online Apr. 21, 2021; retrieved May 5, 2021 (online); <https://www.wayfair.com/furniture/pdp/loon-peak-himrod-tv-stand-for-tvs-up-to-78-w004412411.html>.

Mouton TV Stand; Wayfair.com; found online Apr. 21, 2021; retrieved May 5, 2021 (online); <https://www.wayfair.com/furniture/pdp/foundry-select-mouton-tv-stand-for-tvs-up-to-78-w001812510.html>.

Humphery TV Stand; Google Search; Wayfair.com; found online Apr. 21, 2021; retrieved May 10, 2021 (online); <https://www.hickoryfurniture.com/itembrowser.aspx?action=attributes&itemtype=furniture&event=reset&wsearch=bridgeport>.

Vigue TV Stand; Wayfair.com; found online Apr. 21, 2021; retrieved May 5, 2021 (online); <https://www.wayfair.com/furniture/pdp/foundry-select-vigue-tv-stand-for-tvs-up-to-78-w002881900.html>.

Gorete TV Stand; Wayfair.com; found online Apr. 21, 2021; retrieved May 5, 2021 (online); <https://www.wayfair.com/furniture/pdp/latitude-run-gorete-tv-stand-for-tvs-up-to-78-w004589072.html>.

Alcott Hill TV Stand with Fireplace; Wayfair.com; found online Apr. 21, 2021; retrieved May 5, 2021 (online); <https://www.wayfair.com/furniture/pdp/alcott-hill-santa-tv-stand-for-tvs-up-to-70-with-fireplace-included-w001442995.html?piid=1644522337>.

West Elm Website “furniture” search; Westelm.com; retrieved Apr. 20, 2020 (online); [https://www.westelm.com/shop/furniture/?searchdir=true&cm\\_sp=HeaderLinks-\\_-OnsiteSearch-\\_-MainSite&cm\\_type=OnsiteSearch&term=furniture&searchredirtype=br](https://www.westelm.com/shop/furniture/?searchdir=true&cm_sp=HeaderLinks-_-OnsiteSearch-_-MainSite&cm_type=OnsiteSearch&term=furniture&searchredirtype=br).

Raymour Flanigan Website “Living Rooms” search; raymourflanigan.com; retrieved Nov. 6, 2020 (online); <https://raymourflanigan.com/living-rooms>.

Crate and Barrel Website “Business Interior Design” search; crateandbarrel.com; retrieved Nov. 6, 2020 (online); [https://www.crateandbarrel.com/trade-program/?a=784&campaignid=1061902950&adgroupid=55881134521&targetid=aud-1097585102856:kwd-415008832538&adpos=&creative=251673559670&device=c&matchtype=e&network=g&gclid=Cj0KCQjwytOEBhD5ARIsANnRjVgCRKanmeP5yMquG6rsNP7KAU-nUpzG5NfgZU-PhRCRUgz507lItMaAhvLEALw\\_wcB](https://www.crateandbarrel.com/trade-program/?a=784&campaignid=1061902950&adgroupid=55881134521&targetid=aud-1097585102856:kwd-415008832538&adpos=&creative=251673559670&device=c&matchtype=e&network=g&gclid=Cj0KCQjwytOEBhD5ARIsANnRjVgCRKanmeP5yMquG6rsNP7KAU-nUpzG5NfgZU-PhRCRUgz507lItMaAhvLEALw_wcB).

Crate and Barrel Website “Business Office Design” search; crateandbarrel.com; retrieved Nov. 6, 2020 (online); <https://www.crateandbarrel.ca/trade-program/>.

Penny Mustard Website “Bridgeport” search; pennymustard.com; retrieved May 13, 2020 (online); <https://www.pennymustard.com/search.inc?q=bridgeport&p=1>.

Home Living Furniture Website “coaster furniture, bridgeport, servers” search; homelivingfurniture.com retrieved May 13, 2020 (online); [https://www.homelivingfurniture.com/st/\\_t\\_/105525](https://www.homelivingfurniture.com/st/_t_/105525).

Whitley Furniture Website “dining room, gat-creek, curio cabinets, bridgeport” search whitleygalleries.com; retrieved May 13, 2020 (online); <https://www.whitleygalleries.com/gat-creek-bridgeport-four-door-cabinet/81593-1137/iteminformation.aspx>.

Oak Finish 70-Inch TV Stand, <https://www.inspireq.com/products/oak-finish-tv-stand-e976ak-t>, retrieved Jun. 2, 2021.

Grey Wash Finish TV Stand, <https://www.inspireq.com/collections/living-room/products/grey-wash-finish-tv-stand-with-door-e975gat>, retrieved Jun. 2, 2021.

Matte Black Finish Metal Coat Rack with Ladder Shelf, <https://www.inspireq.com/collections/home-decor/products/matte-black-finish-metal-coat-rack-with-ladder-shelf-e824bk>, retrieved Jun. 2, 2021.

Sadie Low Bookshelf, [https://www.homethreads.com/products/furniture/tv-stands/sadie-low-bookshelf-oak?gclid=CjwKCAjwJ2FBhAuEiwAIKu19o3PBxz3p9PodtUUqKh6fPJHib\\_PGfJlJBjNuddyHp8BBTK412S1BoCgOoQAvD\\_BwE](https://www.homethreads.com/products/furniture/tv-stands/sadie-low-bookshelf-oak?gclid=CjwKCAjwJ2FBhAuEiwAIKu19o3PBxz3p9PodtUUqKh6fPJHib_PGfJlJBjNuddyHp8BBTK412S1BoCgOoQAvD_BwE), retrieved Jun. 2, 2021, available on information and believe as early as Aug. 2013.

Ameriwood Home Farmington Electric Fireplace TV Console for TVs up to 60", Rustic, [https://www.amazon.com/Ameriwood-Home-Farmington-Electric-Fireplace/dp/B01JADOQ52/ref=dp\\_prsubs\\_1?pd\\_rd\\_i=B01JADOQ52&pvc=1](https://www.amazon.com/Ameriwood-Home-Farmington-Electric-Fireplace/dp/B01JADOQ52/ref=dp_prsubs_1?pd_rd_i=B01JADOQ52&pvc=1), retrieved Jun. 2, 2021, available on information and believe as early as Jul. 2016.

Farmington 60 in. Century Barn Pine Wood TV Stand with 2 Drawer Fits TVs Up to 60 in. with Storage Doors, [https://www.homedepot.com/pep/Altra-Furniture-Farmington-60-in-Century-Barn-Pine-Wood-TV-Stand-with-2-Drawer-Fits-TVs-Up-to-60-in-with-Storage-Doors-1783215PCOM/300318849?source=shoppingads&locale=en-US&mtc=Shopping-BA-F\\_HDH-G-D59-59\\_34\\_INTERIOR\\_FURNITURE-MULTI-NA-Feed-PLA-NA-NA-059\\_034\\_006\\_HOME\\_ENTERTAINMENT\\_FURN\\_Home\\_Entertainment&cm\\_mmc=Shopping-BA-F\\_HDH-G-D59-59\\_34\\_INTERIOR\\_FURNITURE-MULTI-NA-Feed-PLA-NA-NA-059\\_034\\_006\\_HOME\\_ENTERTAINMENT\\_FURN\\_Home\\_Entertainment-7170000051494672-58700004993904823-92700061190272430&gclid=CjwKCAjwJ2FBhAuEiwAIKu19pVm9Q\\_uSEY88T0eOkNfZ8IAfWHtpcxTuqczP5-EYfeixW15etjLxoCh\\_QQAvD\\_BwE&gclid=aw.ds](https://www.homedepot.com/pep/Altra-Furniture-Farmington-60-in-Century-Barn-Pine-Wood-TV-Stand-with-2-Drawer-Fits-TVs-Up-to-60-in-with-Storage-Doors-1783215PCOM/300318849?source=shoppingads&locale=en-US&mtc=Shopping-BA-F_HDH-G-D59-59_34_INTERIOR_FURNITURE-MULTI-NA-Feed-PLA-NA-NA-059_034_006_HOME_ENTERTAINMENT_FURN_Home_Entertainment&cm_mmc=Shopping-BA-F_HDH-G-D59-59_34_INTERIOR_FURNITURE-MULTI-NA-Feed-PLA-NA-NA-059_034_006_HOME_ENTERTAINMENT_FURN_Home_Entertainment-7170000051494672-58700004993904823-92700061190272430&gclid=CjwKCAjwJ2FBhAuEiwAIKu19pVm9Q_uSEY88T0eOkNfZ8IAfWHtpcxTuqczP5-EYfeixW15etjLxoCh_QQAvD_BwE&gclid=aw.ds), retrieved Jun. 2, 2021, available on information and believe as early as Dec. 2015.

DIY Media Console—Free Plans, <https://www.shanty-2-chic.com/2015/07/diy-media-console-free-plans.html>, retrieved Jun. 2, 2021, available on information and believe as early as Jul. 2015.

DIY Barn Door Media Console, <https://www.shanty-2-chic.com/2014/06/diy-barn-door-media-console.html>, retrieved Jun. 2, 2021, available on information and believe as early as Jun. 2014.

Joss & Main TV Stand, available on information and believe as early as Jul. 2015.

Rogue Engineer, DIY Rustic Media Center, <https://rogueengineer.com/diy-rustic-media-center-plans/>, retrieved Jun. 2, 2021, available on information and believe as early as Jul. 2015.

Ameriwood Home Bloomfield Natural/Heritage Light Pine TV Stand, <https://www.lowes.com/pd/Ameriwood-Home-Bloomfield-TV-Stand-for-TVs-up-to-60-in-Natural/1003087852>, retrieved Jun. 2, 2021.

Custom 9-Foot Rustic Buffet, <https://www.pinterest.com/pin/40250990400157640/>, retrieved Jun. 2, 2021, available on information and believe as early as Jan. 2017.

Sauder Dakota Pass Credenza, [https://us.amazon.com/dp/B01GK8VWPC/ref=sbl\\_dp\\_x\\_B07LGGGCFQ\\_0](https://us.amazon.com/dp/B01GK8VWPC/ref=sbl_dp_x_B07LGGGCFQ_0), retrieved Jun. 2, 2021, available on information and believe as early as Mar. 2016.

Aspen Antique Red 64" TV Stand, <https://www.sancarlosimports.com/asanredtvst.html>, retrieved Jun. 2, 2021, available on information and believe as early as Dec. 2015.

San Carlos Imports Santiago TV Stand, available on information and believe as early as Dec. 2015.

San Carlos Imports San Felipe TV Stand, available on information and believe as early as Dec. 2015.

Aspen Antique Multi Color 76" TV Stand, <https://www.pinterest.com/pin/315040936427682950/>, retrieved Jun. 2, 2021, available on information and believe as early as Dec. 2015.

San Carlos 65" Rustic TV Stand with Cross, <https://www.sancarlosimports.com/rustic-tv-stand-cross.html>, retrieved Jun. 2, 2021, available on information and believe as early as Dec. 2015.

Laredo Rustic 60" TV Stand, <https://www.pinterest.com/pin/37295503137850917/>, retrieved Jun. 2, 2021, available on information and believe as early as Dec. 2015.

San Carlos 48" TV Stand, <https://www.sancarlosimports.com/sanca48rutvs.html>, retrieved Jun. 2, 2021, available on information and believe as early as Dec. 2015.



(56)

## References Cited

## OTHER PUBLICATIONS

Mountain Modern Cabinet, available on information and believe as early as Oct. 2015.

Safavieh American Homes Collection Sadie Low Bookshelf, Oak, retrieved from <https://www.amazon.com/Safavieh-AMH6525C-American-Collection-Bookshelf/dp/B00MMBHHVK> on Jun. 3, 2021. Safavieh American Homes Collection Sadie Off White Low Bookshelf, found online on May 12, 2021 at [https://www.amazon.com/dp/B004LGP9F0/ref=cm\\_sw\\_su\\_dp?tag=50kud003-20&th=1](https://www.amazon.com/dp/B004LGP9F0/ref=cm_sw_su_dp?tag=50kud003-20&th=1), retrieved Jun. 3, 2021.

Safavieh Sadie Low Bookshelf, found online at <https://web.archive.org/web/20150327201221/https://safavieh.com/furniture/bookcases/amh6525c>, retrieved Jun. 3, 2021, available on information and belief as early as Mar. 27, 2015.

Safavieh Sadie Country Nautical Low Bookshelf, found online on May 10, 2021 at <https://www.walmart.com/ip/Safavieh-Sadie-Country-Nautical-Low-Bookshelf/37549808?selected=true>, retrieved Jun. 3, 2021.

UHURU Furniture & Collectibles Long Low Wooden Bookcase, found online at <https://uhurufurniture.blogspot.com/2011/08/long-low-wooden-bookcase-90.html>, retrieved Jun. 3, 2021, available on information and belief as early as Aug. 17, 2011.

Woven Paths Open Storage TV Stand for TVs up to 80", Espresso, found online on May 10, 2021 at <https://www.walmart.com/ip/Woven-Paths-Open-Storage-TV-Stand-for- TVs-up-to-80-Espresso/411955245>, retrieved Jun. 3, 2021.

Notice of Allowance for U.S. Appl. No. 29/699,063; dated Jun. 17, 2021.

Notice of Allowance for U.S. Appl. No. 29/698,919; dated Jun. 23, 2021.

Office Action for U.S. Appl. No. 29/756,302; dated Jul. 12, 2021.

"Pemberly Row Farmhouse Mesh Sliding Barn Door 32-inch Wood Home Coffee Station." Found online Jun. 30, 2021 at [www.amazon.com](http://www.amazon.com). Product first available Dec. 28, 2018. Retrieved from URL: <https://tinyurl.com/2h79ybk5> (Year: 2018).

"Home Square 2 Piece Farmhouse Mesh Barn Door TV Stand." Found online Jun. 30, 2021 at [www.amazon.com](http://www.amazon.com). Product first available Dec. 6, 2019. Retrieved from URL: <https://www.amazon.com/Home-Square-Farmhouse-Console-Cabinet/dp/B082DZ5J83?th=1> (Year: 2019).

"The Gray Barn Kujawa Sliding Mesh Door Console." Found online Jun. 30, 2021 at [www.overstock.com](http://www.overstock.com). Product reviewed May 11, 2020. Retrieved from URL: <https://tinyurl.com/24ttxchw> (Year: 2020).

"SSLine 32-inch Farmhouse Accent Storage Cabinet." Found online Jun. 30, 2021 at [www.amazon.com](http://www.amazon.com). Product first available Jul. 20, 2020. Retrieved from URL: <https://www.amazon.com/dp/B0915LKX3W/?tag=abnd-20&th=1> (Year: 2020).

"Rustic Cabinet Barn Door Console." Found online Jun. 30, 2021 at [www.ebay.com](http://www.ebay.com). Page dated Sep. 5, 2020. Retrieved from URL: <https://www.ebay.com/itm/313181659463> (Year: 2020).

"Handbird Display Cabinet." Found online Jun. 30, 2021 at [www.kmart.com](http://www.kmart.com). Product first available Jan. 29, 2021. Retrieved from URL: <https://www.kmart.com/handbird-display-cabinet-tv-stand-w-sliding-barn/p-A093830443> (Year: 2021).

Ex Parte Quayle Office Action for U.S. Appl. No. 29/756,303; dated Jul. 12, 2021.

"Walker Edison Weston Modern Farmhouse Sliding Glass Door Storage Console." Found online Jun. 30, 2021 at [www.amazon.com](http://www.amazon.com). Product reviewed Mar. 26, 2019. Retrieved from URL: <https://tinyurl.com/3vnmkj5z7> (Year: 2019).

"Manor Park 32 Sliding Glass Door Accent Cabinet." Found online Jun. 30, 2021 at [www.walmart.com](http://www.walmart.com). Product reviewed Jul. 17, 2020. Retrieved from URL: <https://www.walmart.com/ip/Manor-Park-32-Sliding-Glass-Door-Accent-Cabinet-Solid-White/927438446?selected=true> (Year: 2020).

Notice of Allowance for U.S. Appl. No. 29/756,305; dated Jul. 16, 2021.

Notice of Allowance for U.S. Appl. No. 29/756,291; dated Jul. 14, 2021.

Notice of Allowance for U.S. Appl. No. 29/756,763; dated Jul. 23, 2021.

Sha Cerlin 52" Farmhouse TV Stand with Sliding Barn Door, retrieved from [https://www.amazon.com/SHA-CERLIN-Farmhouse-Adjustable-Entertainment/dp/B094JWM1QF/ref=sr\\_1\\_21?dchild=1&m=A2YBITOQ3E0O2T&marketplaceID=ATVPDKIKX0DER&qid=1626471396&s-merchant-items&sr=1-21](https://www.amazon.com/SHA-CERLIN-Farmhouse-Adjustable-Entertainment/dp/B094JWM1QF/ref=sr_1_21?dchild=1&m=A2YBITOQ3E0O2T&marketplaceID=ATVPDKIKX0DER&qid=1626471396&s-merchant-items&sr=1-21), available on information and belief as of May 10, 2021; retrieved on Aug. 18, 2021.

Sha Cerlin TV Stand, retrieved from [https://www.amazon.com/SHA-CERLIN-Farmhouse-Entertainment-Adjustable/dp/B094SWDB8J/ref=sr\\_1\\_63?dchild=1&keywords=sha+cerlin&qid=1626467539&s=home-garden&sr=1-63](https://www.amazon.com/SHA-CERLIN-Farmhouse-Entertainment-Adjustable/dp/B094SWDB8J/ref=sr_1_63?dchild=1&keywords=sha+cerlin&qid=1626467539&s=home-garden&sr=1-63), available on information and belief as of May 13, 2021; retrieved on Aug. 18, 2021.

Restriction Requirement for U.S. Appl. No. 29/743,423; dated Sep. 7, 2021.

Restriction Requirement for U.S. Appl. No. 29/743,237; dated Sep. 7, 2021.

Walker Edison Willa Modern Farmhouse Sliding Single Slat Door Storage Console. Found online Jun. 30, 2021 at [www.amazon.com](http://www.amazon.com). Product reviewed Jun. 18, 2019. Retrieved from URL: <https://tinyurl.com/4n3s9x45> (Year: 2019).

Woven Paths 32-inch Sliding Slat Door Accent Cabinet. Found online Jun. 30, 2021 at [www.walmart.com](http://www.walmart.com). Product reviewed Sep. 14, 2019. Retrieved from URL: <https://tinyurl.com/2bsjztyv> (Year: 2019).

"Hom Echo Farmhouse Storage Cabinet." Found online Jun. 30, 2021 at [www.amazon.com](http://www.amazon.com). Product first available Oct. 7, 2020. Retrieved from URL: <https://tinyurl.com/9f2yj8ks> (Year: 2020).

"Homcom Rustic Farmhouse Accent Side Cabinet." Found online Jun. 30, 2021 at [www.amazon.com](http://www.amazon.com). Product first available Jan. 20, 2021. Retrieved from URL: <https://tinyurl.com/ntzeu7ey> (Year: 2021).

Office Action for U.S. Appl. No. 29/743,244; dated Sep. 10, 2021.

"Carson Carrington Esbo 48-inch Corner TV Stand Console" Jun. 29, 2020, overstock.com, site visited Sep. 7, 2021 <<https://www.overstock.com/Home-Garden/Carson-Carrington-Esbo-48-2-Door-Glass-Shelf-Corner-TV-Console/30270125/product.html>> (Year: 2020).

Office Action for U.S. Appl. No. 29/743,250; dated Sep. 14, 2021.

Office Action for U.S. Appl. No. 29/743,584; dated Sep. 14, 2021.

Office Action for U.S. Appl. No. 29/743,247; dated Sep. 15, 2021.

Notice of Allowance for U.S. Appl. No. 29/743,240; dated Sep. 15, 2021.

Restriction Requirement for U.S. Appl. No. 29/743,246; dated Sep. 14, 2021.

Notice of Allowance for U.S. Appl. No. 29/743,418; dated Sep. 20, 2021.

Sauder Saddler Way TV Stand for TVs up to 68", Lintel Oak Finish, retrieved from <https://www.walmart.com/ip/Sauder-Saddler-Way-TV-Stand-for- TVs-up-to-65-Lintel-Oak-Finish/522898196> on Sep. 23, 2021.

Sauder Adept Storage Accent Storage Cabinet, For TV's up to 39", Craftsman Oak finish, retrieved from [https://www.amazon.com/Sauder-Adept-Storage-Cabinet-Craftsman/dp/B076FBWJV3/ref=cm\\_cr\\_ar\\_p\\_d\\_product\\_top?ie=UTF8](https://www.amazon.com/Sauder-Adept-Storage-Cabinet-Craftsman/dp/B076FBWJV3/ref=cm_cr_ar_p_d_product_top?ie=UTF8) on Sep. 23, 2021.

Sauder Dakota Pass Entertainment/Fireplace Credenza, For TV's up to 60", Craftsman Oak finish, retrieved from [https://www.amazon.com/Sauder-419119-Entertainment-Fireplace-Craftsman/dp/B016QM1N1K/ref=cm\\_cr\\_ar\\_p\\_d\\_product\\_top?ie=UTF8](https://www.amazon.com/Sauder-419119-Entertainment-Fireplace-Craftsman/dp/B016QM1N1K/ref=cm_cr_ar_p_d_product_top?ie=UTF8) on Sep. 23, 2021.

Fireplace TV Credenza with Glass Doors, retrieved from <https://www.sauder.com/furniture/427377/fireplace-tv-credenza-with-glass-doors> on Sep. 23, 2021.

Sauder Barrister Lane Media Fireplace, for TVs up to 60", Salt Oak finish, retrieved from [https://www.amazon.com/Sauder-Barrister-Fireplace-Entertainment-Accommodates/dp/B07GC88LRN/ref=cm\\_cr\\_ar\\_p\\_d\\_product\\_top?ie=UTF8](https://www.amazon.com/Sauder-Barrister-Fireplace-Entertainment-Accommodates/dp/B07GC88LRN/ref=cm_cr_ar_p_d_product_top?ie=UTF8) on Sep. 23, 2021.

Jaxpety 58" Wooden TV Stand with Glass Door for 65" TVs Farmhouse Style Media Console Storage Cabinet Entertainment Center for Living Room, retrieved from <https://www.sears.com/jaxpety-58inch-wooden-tv-stand-w-glass-door/p-A105951271> on Sep. 28, 2021.

Jaxpety 58" Farmhouse Barn Door TV Stand for TVs up to 65", Wooden Media Console Storage Cabinet for Living Room, Bed-



(56)

## References Cited

## OTHER PUBLICATIONS

room, Brown Oak, retrieved from <https://www.walmart.com/ip/Jaxpety-58-Farmhouse-Barn-Door-TV-Stand-for-TVs-up-to-65-Wooden-Media-Console-Storage-Cabinet-for-Living-Room-Bedroom-Brown-Oak/314330068> on Sep. 28, 2021.

Notice of Allowance for U.S. Appl. No. 29/756,303; dated Oct. 1, 2021.

Office Action for U.S. Appl. No. 29/773,569; dated Oct. 6, 2021.

“Walker Edison Beaumont.” Found online Sep. 13, 2021 at [www.amazon.com](http://www.amazon.com). Product first available Nov. 8, 2018. Retrieved from URL: [https://www.amazon.com/dp/B07K9F9YGF/ref=sbl\\_dp\\_x\\_B092VPQV67\\_0](https://www.amazon.com/dp/B07K9F9YGF/ref=sbl_dp_x_B092VPQV67_0) (Year: 2018).

“Woven Paths Modern Farmhouse Sliding Door Accent.” Found on line Sep. 13, 2021 at [www.walmart.com](http://www.walmart.com). Product reviewed Jan. 19, 2019. Retrieved from URL: <https://www.walmart.com/ip/Woven-Paths-Modern-Farmhouse-Sliding-Door-Accent-Cabinet-Stone-Grey/418425379> (Year: 2019).

“Sauder Adept Storage Accent Storage Cabinet.” Found on line Sep. 13, 2021 at [www.amazon.com](http://www.amazon.com). Product first available Oct. 30, 2017. Retrieved from URL: <https://tinyurl.com/2e7tnx7d> (Year: 2017).

Notice of Allowance for U.S. Appl. No. 29/756,302; dated Oct. 27, 2021.

Office Action for U.S. Appl. No. 29/756,305; dated Nov. 15, 2021. Notice of Allowance for U.S. Appl. No. 29/743,240; dated Nov. 24, 2021.

Notice of Allowance for U.S. Appl. No. 29/743,418; dated Nov. 24, 2021.

“LuxenHome 3 Piece White Wood Bathroom Furniture Set” <https://www.homesquare.com/LuxenHome-3-Piece-White-Wood-Bathroom-Furniture-Set-2397532-PKG.htm> Found online Nov. 12, 2021; Retrieved on Dec. 2, 2021.

“Luxen Home Wood Farmhouse Storage Cabinet” [https://shopping.yahoo.com/product/00810000777488/Luxen-Home-Wood-Farmhouse-Storage-Cabinet?pid=skimlinks\\_310-10477784&guccounter=1](https://shopping.yahoo.com/product/00810000777488/Luxen-Home-Wood-Farmhouse-Storage-Cabinet?pid=skimlinks_310-10477784&guccounter=1) Found online Nov. 12, 2021; Retrieved on Dec. 2, 2021.

“Luxen Home Rustic Chic Sliding Door Wood Cabinet” [https://shopping.yahoo.com/product/00810000772858/Luxen-Home-Rustic-Chic-Sliding-Door-Wood-Cabinet?pid=skimlinks\\_310-9997530](https://shopping.yahoo.com/product/00810000772858/Luxen-Home-Rustic-Chic-Sliding-Door-Wood-Cabinet?pid=skimlinks_310-9997530) Found online Nov. 12, 2021; Retrieved on Dec. 2, 2021.

“LuxenHome Sliding Door White Wood Wall Cabinet” <https://www.cymax.com/Sliding-Door-White-Wood-Wall-Cabinet-WHIF1248.htm> Found online Nov. 12, 2021; Retrieved on Dec. 2, 2021.

“LuxenHöme Natural Oak Finish Wine Bar Cabinet with 2 Drawers, Wood Storage Sideboard with Slide Door, Corner Coffee Table with 2-Layer Storage Shelf for Dining Room Kitchen, 32 inch, Oak Color” [https://www.amazon.com/LuxenH%C3%B6me-Natural-Cabinet-Drawers-Sideboard/dp/B097TTJMMT?ref\\_=ast\\_sto\\_dp&th=1](https://www.amazon.com/LuxenH%C3%B6me-Natural-Cabinet-Drawers-Sideboard/dp/B097TTJMMT?ref_=ast_sto_dp&th=1) Found online Nov. 12, 2021; Retrieved on Dec. 2, 2021.

“LuxenHöme Weathered Wood Storage Single Barn Door Wall Cabinet, Farmhouse Wall Storage with Shelves Inside, Kitchen Wall Cabinet for Daily use, 22 Inch, Disdressed Wood” [https://www.amazon.com/LuxenH%C3%B6me-Weathered-Storage-Farmhouse-Disdressed/dp/B09GL3WNL9/ref=sr\\_1\\_51?dchild=1&m=ADLW6LFQJCQSW&marketplaceID=ATVPDKIKX0DER&qid=1633737779&s=merchant-items&sr=1-51&th=1](https://www.amazon.com/LuxenH%C3%B6me-Weathered-Storage-Farmhouse-Disdressed/dp/B09GL3WNL9/ref=sr_1_51?dchild=1&m=ADLW6LFQJCQSW&marketplaceID=ATVPDKIKX0DER&qid=1633737779&s=merchant-items&sr=1-51&th=1) Found online Nov. 12, 2021; Retrieved on Dec. 2, 2021.

“LuxenHöme Pallet Sliding Door Wood Storage Cabinet, Modern Farmhouse Sliding Single Slat Door Storage Console, Coffee Table with Shelves Inside for Kitchen Living Room Bedroom, 32 inch, White/Brown” <https://www.amazon.com/Luxen-Pallet-Sliding-Storage-Cabinet/dp/B08PDV42M3?th=1> Found online Nov. 12, 2021; Retrieved on Dec. 2, 2021.

“Wampat Farmhouse Sliding Barn Door Accent Cabinet Buffet Entryway Bar Storage Table for Living Room, Bathroom and Home Kitchen, 35 Inch, White” <https://www.ubuy.co.id/en/product/1NJGSUT4-wampat-farmhouse-sliding-barn-door-accent-cabinet-buffet-entryway-bar-storage-table-for-living-room> Found online Nov. 12, 2021; Retrieved on Dec. 2, 2021.

“Belifeglory Barn Door Storage Cabinet, Farmhouse Sliding Barn Door Wood Accent Chest Kitchen Buffet Cabinet with Adjustable

Shelves for Entryway Bar Home Office (Grey)” <https://www.ubuy.co.id/en/product/ZFHQXSX0-belifeglory-barn-door-storage-cabinet-farmhouse-sliding-barn-door-wood-accent-chest-kitchen-buffet-c> Found online Nov. 12, 2021; Retrieved on Dec. 2, 2021.

“Luxen Home Bathroom Wall Storage Cabinet” [https://shopping.yahoo.com/product/00810000773121/Luxen-Home-Bathroom-Wall-Storage-Cabinet?pid=skimlinks\\_310-9997549](https://shopping.yahoo.com/product/00810000773121/Luxen-Home-Bathroom-Wall-Storage-Cabinet?pid=skimlinks_310-9997549) Found online Nov. 12, 2021; Retrieved on Dec. 2, 2021.

“Yosef Entertainment Center for TVs up to 55” <https://www.wayfair.com/furniture/pdp/yosef-entertainment-center-for-tvs-up-to-55-w005296062.html> Found online Nov. 12, 2021; Retrieved on Dec. 2, 2021.

“Saugeen TV Stand for TVs up to 64” <https://www.wayfair.com/furniture/pdp/gracie-oaks-saugeen-tv-stand-for-tvs-up-to-64-w003546807.html> Found online Nov. 12, 2021; Retrieved on Dec. 2, 2021.

“Mcglathin TV Stand For TVs Up To 70” <https://cyewayinc.com/collections/tv-stand/products/mcglathin-tv-stand-for-tvs-up-to-70?variant=40149957247139> Found online Nov. 12, 2021; Retrieved on Dec. 2, 2021.

“Concordia TV Stand for TVs up to 65" with Fireplace Included” <https://www.wayfair.com/furniture/pdp/gracie-oaks-concordia-tv-stand-for-tvs-up-to-65-with-fireplace-included-w004032688.html> Found online Nov. 12, 2021; Retrieved on Dec. 2, 2021.

“Uli 48" Solid Wood Kitchen Island” <https://www.wayfair.com/furniture/pdp/gracie-oaks-uli-kitchen-island-oak-butcher-block-top-grks7182.html> Found online Nov. 12, 2021; Retrieved on Dec. 2, 2021.

“Alayziah 52" Wide Buffet Table” <https://www.wayfair.com/furniture/pdp/gracie-oaks-alayziah-52-wide-buffet-table-w003233776.html> Found online Nov. 12, 2021; Retrieved on Dec. 2, 2021.

“Swedish Hill TV Stand for TVs up to 88" with Fireplace Included” <https://www.wayfair.com/furniture/pdp/gracie-oaks-swedish-hill-tv-stand-for-tvs-up-to-88-with-electric-fireplace-included-w000339756.html> Found online Nov. 12, 2021; Retrieved on Dec. 2, 2021.

“Clematite TV Stand for TVs up to 65” <https://www.wayfair.com/furniture/pdp/gracie-oaks-clematite-tv-stand-for-tvs-up-to-65-w003025551.html> Found online Nov. 12, 2021; Retrieved on Dec. 2, 2021.

“Arti TV Stand for TVs up to 65” <https://www.wayfair.com/furniture/pdp/gracie-oaks-arti-tv-stand-for-tvs-up-to-65-w004646275.html> Found online Nov. 12, 2021; Retrieved on Dec. 2, 2021.

“Garden City TV Stand for TVs up to 65” <https://www.wayfair.com/furniture/pdp/gracie-oaks-garden-city-tv-stand-for-tvs-up-to-65-w002818215.html> Found online Nov. 12, 2021; Retrieved on Dec. 2, 2021.

“Seabeck TV Stand for TVs up to 55" with Fireplace Included” <https://www.wayfair.com/furniture/pdp/gracie-oaks-seabeck-w004878945.html> Found online Nov. 12, 2021 Retrieved on Dec. 2, 2021.

“Theobald End Table” <https://www.wayfair.com/furniture/pdp/gracie-oaks-theobald-end-table-with-storage-w005274882.html> Found online Nov. 12, 2021; Retrieved on Dec. 2, 2021.

“Rossitano Solid Wood End Table” <https://www.wayfair.com/furniture/pdp/gracie-oaks-rossitano-end-table-hlds6279.html> Found online Nov. 12, 2021; Retrieved on Dec. 2, 2021.

“Berneau 30.7" Wide Sideboard” <https://www.wayfair.com/furniture/pdp/gracie-oaks-berneau-307-wide-sideboard-w003399479.html> Found online Nov. 12, 2021; Retrieved on Dec. 2, 2021.

“FurnitureR 32 Inch Sideboard Open Storage Cabinet with Sliding Door, 2 Shelves for Kitchen & Dining Furniture,Manufactured Wood” <https://www.amazon.com/FurnitureR-Sideboard-Storage-Furniture-Manufactured/dp/B097PFWYDT> Found online Nov. 12, 2021; Retrieved on Dec. 2, 2021.

“1—Door Accent Cabinet” <https://www.wayfair.com/furniture/pdp/39f-inc-newbarn-cabinet-tnfi2607.html> Found online Nov. 12, 2021; Retrieved on Dec. 2, 2021.

“Newbarn TV Stand” <https://www.homylin.com/products/newbarn-tv-stand> Found online Nov. 12, 2021 Retrieved on Dec. 2, 2021.

“32" Farmhouse Sliding Barn Door Storage Cabinet ,Wood Accent Cabinet Kitchen Buffet Cabinet With Adjustable Shelves White”



(56)

## References Cited

## OTHER PUBLICATIONS

<https://www.walmart.com/ip/Farmhouse-Sliding-Barn-Storage-Cabinet/306453208> Found online Nov. 12, 2021; Retrieved on Dec. 2, 2021.

“TV Stand with Barn Door, 2 Open Compartments, Cable Management, TV Table for TVs up to 57 Inches” <https://www.walmart.com/ip/TV-Stand-with-Barn-Door-2-Open-Compartments-Cable-Management-TV-Table-for-TVs-up-to-57-Inches/935482009> Found online Nov. 12, 2021; Retrieved on Dec. 2, 2021.

“TV Stand with Barn Door, 2 Open Compartments, Cable Management, TV Table for TVs up to 57 Inches Grey” <https://www.walmart.com/ip/TV-Stand-with-Barn-Door-2-Open-Compartments-Cable-Management-TV-Table-for-TVs-up-to-57-Inches-Grey/379595098> Found online Nov. 12, 2021; Retrieved on Dec. 2, 2021. Office Action for U.S. Appl. No. 29/743,423; dated Dec. 3, 2021. Office Action for U.S. Appl. No. 29/743,246; dated Dec. 6, 2021. Notice of Allowance for U.S. Appl. No. 29/743,237; dated Dec. 13, 2021.

DIY Media Center / Buffet With Barn Doors; “Against the Grain” video; <https://www.youtube.com/watch?v=IOF-uZeuxE>; Found online on Dec. 14, 2021.

Ana White, Grandy Barn Door Console; “How to build barn door console or buffet—free plans by ana-white.com” <http://www.ANA-WHITE.com/woodworking-projects/grandy-barn-door-console>; Found online on Dec. 14, 2021; Retrieved on Dec. 17, 2021.

Notice of Allowance for U.S. Appl. No. 29/743,244; dated Jan. 5, 2022.

Notice of Allowance for U.S. Appl. No. 29/743,247; dated Jan. 5, 2022.

Notice of Allowance for U.S. Appl. No. 29/814,516; dated Jan. 20, 2022.

“Leather Belt Silver Square 2 Inch Buckle” Oct. 11, 2016, bucklemybelt.com, site visited Jan. 4, 2022 <<https://bucklemybelt.com/products/silver-square-2-inch-leather-belt>> (Year: 2016).

“Superstrut 5-Count 3/4-in Galvanized/Coated Square Washer” Jul. 6, 2018, lowes.com, site visited Jan. 4, 2022 <<https://www.lowes.com/pd/Superstrut-5-Count-3-4-inch-Galvanized-Coated-Square-Washers/3284472>> (Year: 2018).

“2" Wide Brass Leather Belt . . .” Mar. 6, 2019, etsy.com, site visited Jan. 4, 2022 <[https://www.etsy.com/listing/548206878/2-wide-brass-leather-belt-2-inch-belt?click\\_key=e4f72ca8f0645d9ccb32a01b02514d7ff873a3aa%3A548206878&click\\_sum=d7a93e5e&rec\\_type=ss&ref=landingpage\\_similar\\_listing\\_top-1&frs=1](https://www.etsy.com/listing/548206878/2-wide-brass-leather-belt-2-inch-belt?click_key=e4f72ca8f0645d9ccb32a01b02514d7ff873a3aa%3A548206878&click_sum=d7a93e5e&rec_type=ss&ref=landingpage_similar_listing_top-1&frs=1)> (Year: 2019).

Notice of Allowance for U.S. Appl. No. 29/743,250; dated Jan. 20, 2022.

Notice of Allowance for U.S. Appl. No. 29/743,584; dated Jan. 20, 2022.

Notice of Allowance for U.S. Appl. No. 29/815,518; dated Jan. 24, 2022.

“The Gray Barn Wind Gap 58-inch Sliding Barn Door TV Console” Nov. 6, 2021, overstock.com, site visited Jan. 3, 2022 <<https://www.overstock.com/Home-Garden/The-Gray-Barn-Wind-Gap-58-Sliding-Barn-Door-TV-Console/21852732/product.html>> (Year: 2021).

“Rustic 68" White Barn-Door Media Console” Apr. 19, 2017, houzz.com, site visited Jan. 3, 2022 <[https://www.houzz.com/products/rustic-68-white-barn-door-media-console-prvw-vr-82074454?m\\_refid=PLA\\_HZ\\_82074454\\_10577457359&device=c&nw=u&gclid=EA1alQobChMI-6a19byW9QIV9walCR0UqQJUEAQYBSABEgKqlvD\\_BwE](https://www.houzz.com/products/rustic-68-white-barn-door-media-console-prvw-vr-82074454?m_refid=PLA_HZ_82074454_10577457359&device=c&nw=u&gclid=EA1alQobChMI-6a19byW9QIV9walCR0UqQJUEAQYBSABEgKqlvD_BwE)> (Year: 2017).

Notice of Allowance for U.S. Appl. No. 29/773,569; dated Feb. 2, 2022.

Office Action for U.S. Appl. No. 29/720,729, dated Feb. 4, 2022. Tier Top 2-Door TV Stand by Copper Grove, first available: Sep. 27, 2019. Overstock.com [online], [site visited Jan. 10, 2022], Internet URL: <https://www.overstock.com/Home-Garden/Copper-Grove-60-Tiered-2-Door-TV-Stand-Console-60-x-16-x-28H/28274571/product.html?opre=1&option=49501574#review-aggregation-region> (Year: 2019).

Classic 2-Door Tiered TV Console by Home Accent Furnishings, first available: Jun. 16, 2020. Amazon.com [online], [site visited Jan. 10, 2022], Internet URL: <https://www.amazon.com/60-Classic-2-Door-Tiered-Console/dp/B08B BCXJ PS> (Year: 2020).

Office Action for U.S. Appl. No. 29/720,927; dated Feb. 4, 2022. Fireplace TV Console by Carson Carrington, first available: Apr. 10, 2020. Overstock.com [online], [site visited Jan. 10, 2022], Internet URL: <https://www.overstock.com/Home-Garden/Carson-Carrington-60-Fireplace-TV-Console-60-x-16-x-28H/28790125/product.html> (Year: 2020).

TV Stand with Fireplace by Wrought Studio, first available: Sep. 18, 2019. Wayfair.com [online], [site visited Jan. 10, 2022], Internet URL: <https://www.wayfair.com/furniture/pdp/wrought-studio-eglinton-tv-stand-for-tvs-up-to-65-with-electric-fireplace-included-w006544022.html?piid=205535335> (Year: 2019).

Office Action for U.S. Appl. No. 29/720,942; dated Feb. 4, 2022. Tier Top Fireplace by The Gray Barn, first available: Oct. 1, 2020. Overstock.com [online], [site visited Jan. 10, 2022], Internet URL: <https://www.overstock.com/Home-Garden/The-Gray-Barn-70-Tiered-Top-Open-Shelf-Fireplace-TV-Console-70-x-16-x-26H/28790042/product.html> (Year: 2020).

TV Stand with Fireplace by Millwood Pines, first available: Sep. 8, 2019. Wayfair.com [online], [site visited Jan. 10, 2022], Internet URL: <https://www.wayfair.com/furniture/pdp/millwood-pines-woodbury-tv-stand-for-tvs-up-to-78-with-electric-fireplace-included-w005270949.html?piid=713008694> (Year: 2019).

Office Action for U.S. Appl. No. 29/720,948; dated Feb. 4, 2022. Industrial 3-Door Buffet Sideboard by Walker Edison, first available: Jul. 18, 2019. Amazon.com [online], [site visited Jan. 10, 2022], Internet URL: [https://www.amazon.com/Walker-Edison-Furniture-Company-AZU48RAD3DSG/dp/B07VF58RD6/ref=sr\\_1\\_12](https://www.amazon.com/Walker-Edison-Furniture-Company-AZU48RAD3DSG/dp/B07VF58RD6/ref=sr_1_12) (Year: 2019).

Wide Buffet Table by Gracie Oaks, first available: Aug. 23, 2019. Wayfair.com [online], [site visited Jan. 10, 2022], Internet URL: <https://www.wayfair.com/furniture/pdp/gracie-oaks-dostie-48-wide-buffet-table-w006543360.html?piid=625134232> (Year: 2019).

Office Action for U.S. Appl. No. 29/720,734; dated Feb. 8, 2022. Metal Accent TV Console by The Gray Barn, first available: Jul. 31, 2019. Overstock.com [online], [site visited Jan. 10, 2022], Internet URL: <https://www.overstock.com/Home-Garden/The-Gray-Barn-70-Metal-X-Accent-TV-Stand-Console-70-x-16-x-25H/28274605/product.html#review-aggregation-region> (Year: 2019).

Daisy-Jayne TV Stand by Gracie Oaks, first available: Unknown. Wayfair.com [online], [site visited Jan. 10, 2022], Internet URL: <https://www.wayfair.com/furniture/pdp/gracie-oaks-li-aoliving-room-traditional-style-tv-cabinet-entertainment-center-storage-table-2-cabinets-and-2-shelves-suitable-for-tvs-up-to-65-inchesbrown-w006674724.html> (Year: 2022) (Year: 2022).

Camargue TV Stand by Williston Forge, first available: Nov. 28, 2021. Website [online], [site visited Jan. 10, 2022], Internet URL: <https://www.wayfair.com/furniture/pdp/williston-forge-camargue-tv-stand-for-tvs-up-to-65-w005578471.html> (Year: 2020).

Enzo Entertainment Center by Foundstone, first available: Feb. 1, 2020. Wayfair.com [online], [site visited Jan. 10, 2022], Internet URL: <https://www.wayfair.com/furniture/pdp/foundstone-enzo-entertainment-center-for-tvs-up-to-78-w004433726.html> (Year: 2020). Notice of Allowance for U.S. Appl. No. 29/743,423; dated Feb. 16, 2022.

Notice of Allowance for U.S. Appl. No. 29/815,516; dated Feb. 16, 2022.

Office Action for U.S. Appl. No. 29/756,302; dated Feb. 22, 2022. VINGLI Rustic Electric Fireplace TV Stand with Barn Doors, 60 Inch TV Stand with Fireplace, Fireplace Media Console with Remote, White Oak; <https://www.amazon.ca/VINGLI-Rustic-Electric-Fireplace-Console/dp/B08PK1M5Q9>; Found online on Feb. 25, 2022; Retrieved on Feb. 28, 2022.

Vingli Electric Fireplace TV Stand 65 inch, Oak Electric Fireplace Entertainment Center; Retrieved on Feb. 2, 2022 (no url).

Notice of Allowance for U.S. Appl. No. 29/756,303; dated Feb. 24, 2022.

Notice of Allowance for U.S. Appl. No. 29/756,305; dated Feb. 28, 2022.







(56)

## References Cited

## OTHER PUBLICATIONS

ZGdlE5hbWU9c3BfbXRmJmFjdGlVbj1jbGlja1JIZGIyZWNOJmRvTm90TG9nQ2xpY2s9dHJlZQ==; Retrieved Apr. 19, 2022.

Belleze Modern 50 Inch Farmhouse Electronic Fireplace TV Stand & Media Entertainment Center Console Table for TVs up to 55 Inch with Open Storage Shelves & Cabinets—Kenton (Sargent Oak); [https://www.amazon.com/BELLEZE-Traditional-Console-Electric-Fireplace/dp/B081QY7D89/ref=sr\\_1\\_49?dchild=1&keywords=BELLEZE&qid=1586369491&sr=8-49&th=1](https://www.amazon.com/BELLEZE-Traditional-Console-Electric-Fireplace/dp/B081QY7D89/ref=sr_1_49?dchild=1&keywords=BELLEZE&qid=1586369491&sr=8-49&th=1); Retrieved Apr. 19, 2022.

Belleze Preston 57 Inch TV Stand Storage Cabinet Shelves Media Console, Rustic Oak; <https://www.walmart.com/ip/BELLEZE-Preston-57-Inch-TV-Stand-Storage-Cabinet-Shelves-Media-Console/570873266>; Retrieved Apr. 19, 2022.

Belleze Fireplace TV Stand Media Entertainment Center—Cayman (Brown); <https://www.walmart.com/ip/BELLEZE-60-Entertainment-Center-TV-Stand-Console-With-Shelves-For-Televisions-up-to-65-Wide-W-Fireplace/389600040>; Retrieved Apr. 19, 2022.

Belleze Modern 58 Inch Farmhouse TV Stand & Media Entertainment Center Console Table for TVs up to 65 Inch with Sliding Barn Door and Storage Cabinets—Truman (Espresso); [https://www.amazon.com/BELLEZE-Sliding-Console-Entertainment-Sargent/dp/B08D3DQMRS/ref=sr\\_1\\_117\\_sspa?dchild=1&keywords=BELLEZE&qid=1586370992&sr=8-117-spons&spLa=ZW5jcnlwdGVkUXVhbGlmaWVyPUPFPQIFJRENARURZQ1MmZW5jcnlwdGVkSWQ9QTAWNTk1MDAxSDhMUESzVIOM0oxJmVuY3J5cHRIZEFkS WQ9QTA1NDAYnJxcRVNGU09BMzIzSVURHJndpZGdlE5hbWU9c3BfbXRmJmFjdGlVbj1jbGlja1JIZGIyZWNOJmRvTm90TG9nQ2xpY2s9dHJlZQ&th=1](https://www.amazon.com/BELLEZE-Sliding-Console-Entertainment-Sargent/dp/B08D3DQMRS/ref=sr_1_117_sspa?dchild=1&keywords=BELLEZE&qid=1586370992&sr=8-117-spons&spLa=ZW5jcnlwdGVkUXVhbGlmaWVyPUPFPQIFJRENARURZQ1MmZW5jcnlwdGVkSWQ9QTAWNTk1MDAxSDhMUESzVIOM0oxJmVuY3J5cHRIZEFkS WQ9QTA1NDAYnJxcRVNGU09BMzIzSVURHJndpZGdlE5hbWU9c3BfbXRmJmFjdGlVbj1jbGlja1JIZGIyZWNOJmRvTm90TG9nQ2xpY2s9dHJlZQ&th=1); Retrieved Apr. 19, 2022.

Prepac Sonoma 72 inch TV Stand, Espresso; [https://www.walmart.com/ip/Sonoma-72-inch-TV-Stand-Espresso/945247253?wmlspartner=wlp&selectedSellerId=0&adid=2222222227&wl0=&wl1=g&wl2=c&wl3=341753167656&wl4=pla-293946777986&wl5=9029714&wl6=&wl7=&wl8=&wl9=pla&wl10=8175035&wl11=online&wl12=945247253&veh=sem&gclid=CjwKCAjwkPX0BRBKEiwA7THxiOgc\\_QK1wR1QW9YqoSdx\\_uf4dQ2sBw9n8brCJ-Sfp7AwN2vV-nUwXR0CSV8QAvD\\_BwE](https://www.walmart.com/ip/Sonoma-72-inch-TV-Stand-Espresso/945247253?wmlspartner=wlp&selectedSellerId=0&adid=2222222227&wl0=&wl1=g&wl2=c&wl3=341753167656&wl4=pla-293946777986&wl5=9029714&wl6=&wl7=&wl8=&wl9=pla&wl10=8175035&wl11=online&wl12=945247253&veh=sem&gclid=CjwKCAjwkPX0BRBKEiwA7THxiOgc_QK1wR1QW9YqoSdx_uf4dQ2sBw9n8brCJ-Sfp7AwN2vV-nUwXR0CSV8QAvD_BwE)

AV 48 in. Black Composite TV Stand Fits TVs Up to 48 in. with Cable Management; <https://www.homedepot.com/p/Prepac-AV-48-in-Black-Composite-TV-Stand-Fits-Televisions-Up-to-48-in-with-Cable-Management-BPV-4701/203055128>; Retrieved Apr. 19, 2022.

AV 48 in. Black Composite TV Stand First TVs Up to 48 in. with Cable Management; <https://www.homedepot.com/p/Prepac-AV-48-in-Black-Composite-TV-Stand-Fits-Televisions-Up-to-48-in-with-Cable-Management-BCV-4722/203055129>; Retrieved Apr. 19, 2022.

Assembly Instructions for Z-Line Designs ZEN 50" W Plasma/Flat Panel TV Mount Stand Model CC785BO-50S.

Office Action for U.S. Appl. No. 29/743,246, dated May 2, 2022.

Notice of Allowance for U.S. Appl. No. 29/815,518, dated May 4, 2022.

Office Action for U.S. Appl. No. 29/767,919, dated May 24, 2022.

Tessa Solid Wood Prism Sideboard by Walker Edison, first available: Unknown. Walkeredison.com [online], [site visited May 17, 2022], Internet URL: <https://walkeredison.com/collections/wood-consoles/products/tessa-solid-wood-prism-sideboard?variant=39272919203906> (Year: 2022).

Tessa Caramel Sideboard by Walker Edison, first available: Aug. 29, 2021. Bellacor.com [online], [site visited May 17, 2022], Internet URL: <https://www.bellacor.com/productdetail/walker-edison-furniture-co-bu58tesswca-tessa-caramel-sideboard-2330350.html> (Year: 2021).

Office Action for U.S. Appl. No. 29/720,729; dated May 24, 2022.

Final Office Action for U.S. Appl. No. 29/720,927; dated May 24, 2022.

Office Action for U.S. Appl. No. 29/720,942; dated May 24, 2022.

Office Action for U.S. Appl. No. 29/768,116; dated May 24, 2022.

Caramel and Black TV Stand by Walker Edison Furniture Co, first available: Sep. 1, 2021. Bellacor.com [online], [site visited May 18, 2022], Internet URL: <https://www.bellacor.com/productdetail/walker-edison-furniture-co-w70fln3dcabl-caramel-and-black-tv-stand-2343976.html> (Year: 2021).

Heitzman Solid Wood TV Stand by Mercury Row, first available: Jul. 1, 2021. Wayfair.com [online], [site visited May 18, 2022], Internet URL: <https://www.wayfair.com/furniture/pdp/mercury-row-heitzman-solid-wood-tv-stand-for-tvs-up-to-85-w005039715.html?piid=331763805> (Year: 2021).

Flint TV Stand by Walker Edison, first available: Unknown. Walkeredison.com [online], [site visited May 18, 2022], Internet URL: <https://walkeredison.com/collections/wood-consoles/products/modern-boho-3-grooved-door-wood-tv-stand-for-tvs-up-to-80?variant=39311011479618> (Year: 2022).

Notice of Allowance for U.S. Appl. No. 29/720,948; dated May 31, 2022.

Restriction Requirement for U.S. Appl. No. 29/767,917, dated Jun. 2, 2022.

Mid Century Chevron Solid Pine Accent Cabinet by Sacacina Home, first available: Unknown. Target.com [online], [site visited May 16, 2022], Internet URL: <https://www.target.com/p/mid-century-chevron-solid-pine-wood-accent-cabinet-caramel-sacacina-home/-/A-82820883> (Year: 2022).

Eloise Wood Detail Accent Cabinet by Walker Edison, first available: Unknown. Walkeredison.com [online], [site visited May 16, 2022], Internet URL: <https://walkeredison.com/collections/accent-tables/products/eloise-wood-detail-accent-cabinet?variant=39272893415490> (Year: 2022).

Grimsley 33" Tall Solid Wood 2 by Mercury Row, first available: Apr. 10, 2021. Wayfair.com [online], [site visited May 16, 2022], Internet URL: <https://www.wayfair.com/furniture/pdp/mercury-row-grimsley-33-tall-solid-wood-2-door-accent-cabinet-w004897558.html> (Year: 2021).

Office Action for U.S. Appl. No. 29/756,302, dated Jun. 3, 2022.

Notice of Allowance for U.S. Appl. No. 29/720,734, dated Jun. 8, 2022.

Notice of Allowance for U.S. Appl. No. 29/743,246, dated Jun. 9, 2022.

TV Stand with Barn Doors; <https://www.vasagleb2b.com/product/living-room/tv-stands/tv-stand-with-door.html>; retrieved on Jun. 24, 2022.

58 in. Saw Cut-Off White TV Stand for TVs up to 65 in. with Electric Fireplace; <https://www.ebay.com/itm/144363603712?hash=item219cbdc700:g:jplAAOSwidVh2sgu>; retrieved on Jun. 24, 2022.

LuxenHome Farmhouse White and Walnut Engineered Wood Cabinet; <https://www.cymax.com/LuxenHome-Farmhouse-White-and-Walnut-Engineered-Wood-Cabinet-WHIF1383.htm>; retrieved on Jun. 24, 2022.

LuxenHome Weathered Brown Wood Storage Single Barn Door Wall Cabinet; <https://www.cymax.com/LuxenHome-Weathered-Wood-Storage-Single-Barn-Door-Wall-Cabinet-WHIF1496.htm>; Retrieved on Jun. 24, 2022.

LuxenHome Natural Oak Finish Wine Bar Cabinet with 2 Drawers, Wood Storage Sideboard with Slide Door, Corner Coffee Table with 2-Layer Storage Shelf for Dining Room Kitchen, 32 inch, Oak Color; [https://www.amazon.com/LuxenHome-Natural-Cabinet-Drawers-Sideboard/dp/B097TTJMMT?ref=ast\\_sto\\_dp&th=1](https://www.amazon.com/LuxenHome-Natural-Cabinet-Drawers-Sideboard/dp/B097TTJMMT?ref=ast_sto_dp&th=1); retrieved on Jun. 24, 2022.

LuxenHome Farmhouse Rustic Engineered Wood Tall Cabinet; <https://www.cymax.com/LuxenHome-Farmhouse-Rustic-Engineered-Wood-Tall-Cabinet-WHIF1381.htm#&gid=1&pid=1>; retrieved on Jun. 24, 2022.

LuxenHome Rustic Wood Storage Cabinet with Sliding Barn Door, Storage Organizer with 2 Drawer, Vintage End Table Console Cabinet for Kitchen Living Room Bedroom, 24 inch, Wood Grain; [https://www.amazon.com/LuxenHome-Storage-Cabinet-Sliding-Organizer/dp/B09DMZPP4J?ref=ast\\_sto\\_dp](https://www.amazon.com/LuxenHome-Storage-Cabinet-Sliding-Organizer/dp/B09DMZPP4J?ref=ast_sto_dp); retrieved on Jun. 24, 2022.

LuxenHome Black and Oak Engineered Wood Storage Wine Cabinet; <https://www.homesquare.com/LuxenHome-Black-and-Oak-Engineered-Wood-Storage-Wine-Cabinet-WHIF1510.htm>; retrieved on Jun. 24, 2022.

LuxenHome Sliding Door White Wood Wall Cabinet, Farmhouse Wall Storage with Plastic Rattan Mesh Door, Kitchen Wall Cabinet with Shelves Inside, 20 Inch, Off-White; [https://www.amazon.com/LuxenHome-Sliding-Cabinet-Farmhouse-Off-White/dp/B09DTG6RRP?ref=ast\\_sto\\_dp&th=1](https://www.amazon.com/LuxenHome-Sliding-Cabinet-Farmhouse-Off-White/dp/B09DTG6RRP?ref=ast_sto_dp&th=1); retrieved on Jun. 24, 2022.



(56)

## References Cited

## OTHER PUBLICATIONS

Luxen Home Farmhouse Antique White Wood Storage Cabinet; <https://www.ubuy.co.id/en/product/1A3N7MWH6-luxen-home-wood-farmhouse-storage-cabinet-white#gallery-1>; retrieved on Jun. 24, 2022.

LuxenHome Rustic Sliding One Door Wood Cabinet Distressed Farmhouse Cabinet with 4 Drawer, Drawer Chest with Inside Shelves, Nightstand for Living Room, Bedroom, 32 Inch; [https://www.amazon.com/LuxenH%C3%B6me-Rustic-Sliding-Door-Cabinet/dp/B08D6ZBDXD?ref=ast\\_sto\\_dp](https://www.amazon.com/LuxenH%C3%B6me-Rustic-Sliding-Door-Cabinet/dp/B08D6ZBDXD?ref=ast_sto_dp); retrieved on Jun. 24, 2022.

LuxenHome Rustic Sliding Door Wood Cabinet; [https://www.amazon.com/LuxenH%C3%B6me-Rustic-Sliding-Door-Cabinet/dp/B09F5M9LQX?ref=ast\\_sto\\_dp](https://www.amazon.com/LuxenH%C3%B6me-Rustic-Sliding-Door-Cabinet/dp/B09F5M9LQX?ref=ast_sto_dp); retrieved on Jun. 24, 2022.

LuxenHome Black and Oak Manufactured Wood 2-Door Buffet Sideboard Cabinet; <https://www.homesquare.com/LuxenHome-Black-and-Oak-Engineered-Wood-Buffet-Sideboard-Storage-Cabinet-WHIF1511.htm>; retrieved on Jun. 24, 2022.

Dajuana TV Stand for TVs up to 65" with Fireplace Included; <https://www.wayfair.com/furniture/pdp/gracie-oaks-60-electric-fireplace-tv-stand-for-tvs-up-to-65-entertainment-center-media-storage-television-console-with-remote-control-for-living-room-gray-w006680975.html?piid=831677979>; Jun. 24, 2022.

Hazelip TV Stand for TVs up to 65" with Fireplace Included; <https://www.wayfair.com/furniture/pdp/hazelip-tv-stand-for-tvs-up-to-65-with-electric-fireplace-included-w004168317.html>; retrieved on Jun. 24, 2022.

Hallway Storage Cabinet With Sliding Door & Drawer, FSB59-N; <https://haotiangr.com/collections/kitchen-and-dinner-room/products/copy-of-haotian-fsb59-n-storage-cabinet-sideboard-with-sliding-door-kitchen-living-room-storage-cabinet-cupboard-hallway-shoe-cabinet?variant=39735832379490>; retrieved on Jun. 28, 2022.

Hallway Sideboard with 2 Sliding Doors, FSB60-N; <https://haotiangr.com/products/copy-of-haotian-kitchen-dining-room-living-room-storage-cabinet-cupboard-sideboard-grey-fsb25-hg?variant=39735832346722>; retrieve on Jun. 28, 2022.

Office Action for U.S. Appl. No. 29/785,154; dated Jul. 15, 2022. Little Italy TV Stand by Trent Austin Design, first available: Jul. 14, 2019. Wayfair.com [online], [site visited Jul. 7, 2022], Internet URL: <https://www.wayfair.com/furniture/pdp/trent-austin-design-little-italy-tv-stand-for-tvs-up-to-58-w008054711.html?piid=824835749> (Year: 2019).

Office Action for U.S. Appl. No. 29/794,743; dated Jul. 15, 2022. Farmhouse Glass and Wood TV Stand by Walker Edison, first available: Jun. 3, 2020. Amazon.com [online], [site visited Jul. 8, 2020], Internet URL: <https://www.amazon.com/Walker-Edison-Farmhouse-Universal-Entertainment/dp/B07TGFTWQR?th=1> (Year: 2020).

Office Action for U.S. Appl. No. 29/794,737; dated Jul. 15, 2022. Avenue Contemporary TV Stand by Delacora, first available: Feb. 26, 2019. Amazon.com [online], [site visited Jul. 7, 2019], Internet URL: <https://www.amazon.com/Delacora-BD52AV2DWH-WE-BD52AV2D-Avenue-Cabinet/dp/B0888DP7QZ?th=1> (Year: 2019). Modern Glass and Wood Universal TV Stand by Walker Edison, first available: Feb. 12, 2018. Amazon.com [online], [site visited Jul. 7, 2022], Internet URL: [https://www.amazon.com/dp/B071KWNS3X/ref=twister\\_B095F8LVD2?th=1](https://www.amazon.com/dp/B071KWNS3X/ref=twister_B095F8LVD2?th=1) (Year: 2018).

Office Action for U.S. Appl. No. 29/794,351; dated Jul. 18, 2022. Tucker Barn Door Fireplace TV Stand by Home Accent Furnishings, first available: Jun. 1, 2018. Amazon.com [online], [site visited Jul. 11, 2022], Internet URL: <https://www.amazon.com/Home-Accent-Furnishings-Fireplace-Television/dp/B07DGP6T17> (Year: 2018).

Office Action for U.S. Appl. No. 29/794,596; dated Jul. 29, 2022. Absalon Corner TV Stand by Millwood Pines, first available: Dec. 10, 2019. Wayfair.com [online], [site visited Jul. 11, 2022], Internet U R L: <https://www.wayfair.com/furniture/pdp/millwood-pines-absolon-corner-tv-stand-for-tvs-up-to-55-w004759506.html?piid=1245037994> (Year: 2019).

Vivian Mid-Century Modern Wine Buffet—Buylateral; <https://www.target.com/p/vivian-mid-century-modern-wine-buffet-buylateral/-/A-87008255?preselect=86325669#lnk=sametab>; Retrieved on Aug. 3, 2022.

Amerlife 3 Piece Living Room Table Set—Includes Coffee Table, End Table & Entry Table for Modern Farmhouse/Industrial Style—Rustic Oak; <https://www.amazon.com/dp/B09PH5J1QG>; Retrived on Aug. 3, 2022.

Costway 58" Corner TV Stand 4 Cubby Entertainment Media Console w/ 2 Shelves; <https://www.target.com/p/costway-58-corner-tv-stand-4-cubby-entertainment-media-console-w-2-shelves/-/A-84038415#lnk=sametab>; Retrieved on Aug. 3, 2022.

Kopf TV Stand for TVs up to 70"; <https://www.wayfair.com/furniture/pdp/three-posts-kopf-tv-stand-for-tvs-up-to-70-w007147538.html>; Retrived on Aug. 3, 2022.

Tavin TV Stand for TVs up to 78"; <https://www.wayfair.com/furniture/pdp/steelside-tavin-tv-stand-for-tvs-up-to-78-w004589072.html>; Retrieved on Aug. 3, 2022.

Kopec TV Stand for TVs up to 65"; <https://www.wayfair.com/furniture/pdp/three-posts-kopec-tv-stand-for-tvs-up-to-65-w007149894.html?piid=1943323452>; Retrieved on Aug. 3, 2022.

Notice of Allowance for U.S. Appl. No. 29/720,942, dated Aug. 3, 2022.

Javier TV Stand for TVs up to 55"; <https://www.wayfair.ca/furniture/pdp/brayden-studio-javier-tv-stand-for-tvs-up-to-55-brsu1013.html>; retrieved on Aug. 8, 2022.

Office Action for U.S. Appl. No. 29/720,729; dated Aug. 11, 2022.

Office Action for U.S. Appl. No. 29/767,917; dated Aug. 25, 2022.

Office Action for U.S. Appl. No. 29/794,592; dated Aug. 25, 2022.

Vintage Modern Luxury Furniture Sideboard by Fujian Kegao Furniture Co, first available: Jun. 4, 2021. Website [online], [site visited Aug. 15, 2022], Internet URL: [https://www.alibaba.com/product-detail/Nintage-Modern-Luxury-Furniture-OAK-Wood\\_1600101109396.html](https://www.alibaba.com/product-detail/Nintage-Modern-Luxury-Furniture-OAK-Wood_1600101109396.html) (Year: 2021).

Office Action for U.S. Appl. No. 29/797,119; dated Aug. 25, 2022.

Brumit 59" Wide 4 Drawer Sideboard by Mercury Row, first available: Aug. 25, 2020. Wayfair.com [online], [site visited Aug. 8, 2022], Internet URL: <https://www.wayfair.com/Mercury-Row%C2%AE--Brumit-59-Wide-4-Drawer-Sideboard-X114445641-L161-K-W003334530.html> (Year: 2020).

Sliding Slat Door Sideboard by Middlebrook Designs, first available: Aug. 8, 2020. Overstock.com [online], [site visited Aug. 12, 2022], Internet URL: <https://www.overstock.com/Home-Garden/Middlebrook-Designs-Sliding-Slat-Door-Sideboard/31644839/product.html#reviewRegion> (Year: 2020).

Office Action for U.S. Appl. No. 29/818,157; dated Aug. 25, 2022.

71" Venna Industrial Farmhouse X Leg Trestle Dining Table by Saracina Home, first available: Jul. 30, 2021. Target.com [online], [site visited 00/00/0000], Internet URL: <https://www.target.com/p/71-34-venna-industrial-farmhouse-x-leg-trestle-dining-table-rustic-oak-saracina-home/-/A-82831104> (Year 2021).

Notice of Allowance for U.S. Appl. No. 29/768,116; dated Aug. 31, 2022.

Notice of Allowance for U.S. Appl. No. 29/720,927; dated Sep. 14, 2022.

58" TV Stand for TVs up to 65" with Electric Fireplace Oak—Home Essentials; <https://www.target.com/p/58-34-tv-stand-for-tvs-up-to-65-34-with-electric-fireplace-oak-home-essentials/-/A-81967912#lnk=sametab>; retrieved on Sep. 20, 2022.

Amerlife Fireplace TV Stand Sliding Barn Door Wood Entertainment Center with a 23" Electric Fireplace Insert, Modern Farmhouse Storage Cabinet Console for TVs Up to 65", Distressed White & Barnwood; <https://www.walmart.com/ip/Amerlife-Fireplace-TV-Stand-Sliding-Barn-Door-Wood-Entertainment-Center-23-Electric-Insert-Modern-Farmhouse-Storage-Cabinet-Console- TVs-Up-65-Distres/983471069>; retrieved on Oct. 12, 2022.

Fireside 48 in. Wooden Electric Fireplace TV Stand in Rustic Brown, with Sliding Barn Door, Entertainment Center; <https://www.homedepot.com/p/TURBRO-Fireside-48-in-Wooden-Electric-Fireplace-TV-Stand-in-Rustic-Brown-with-Sliding-Barn-Door-Entertainment-Center-FS48/315692701>; retrieved on Oct. 12, 2022.

Notice of Allowance for U.S. Appl. No. 29/756,302; dated Oct. 13, 2022.



(56)

**References Cited**

OTHER PUBLICATIONS

Notice of Allowance for U.S. Appl. No. 29/767,917; dated Oct. 13, 2022.

Notice of Allowance for U.S. Appl. No. 29/767,919; dated Oct. 24, 2022.

Notice of Allowance for U.S. Appl. No. 29/720,729; dated Nov. 7, 2022.

Notice of Allowance for U.S. Appl. No. 29/768,116; dated Nov. 16, 2022.

\* cited by examiner



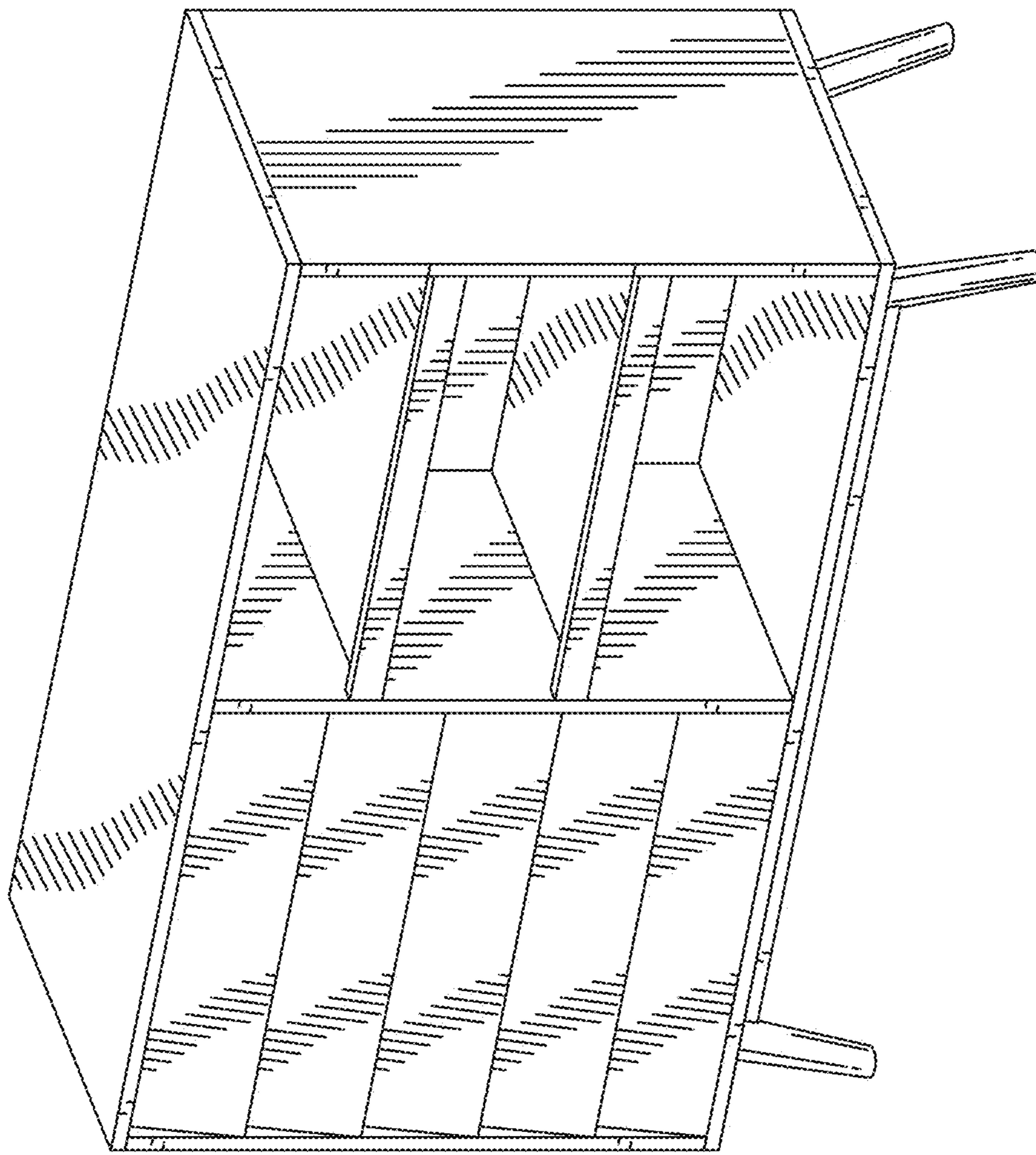

FIG. 1



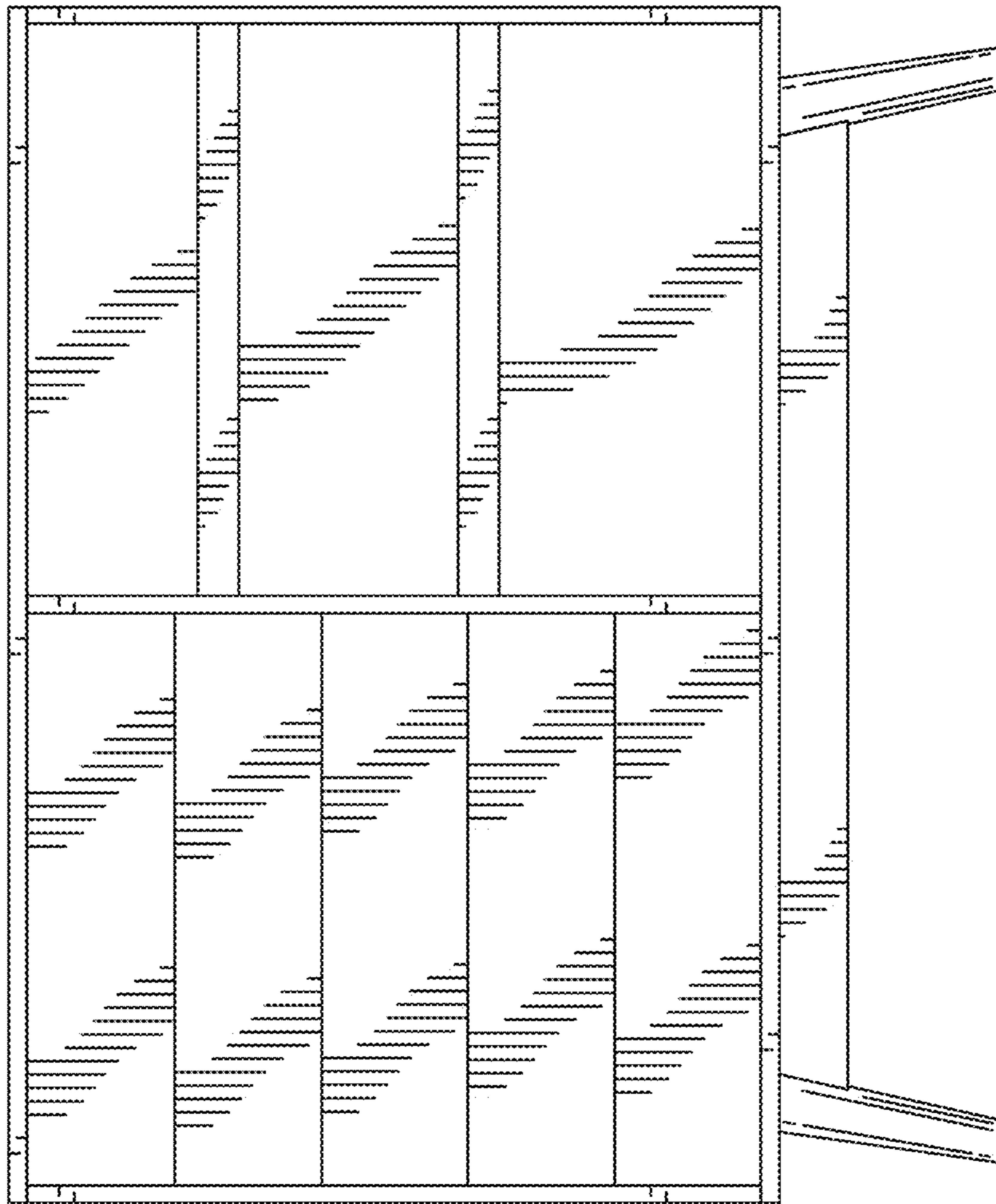

FIG. 2



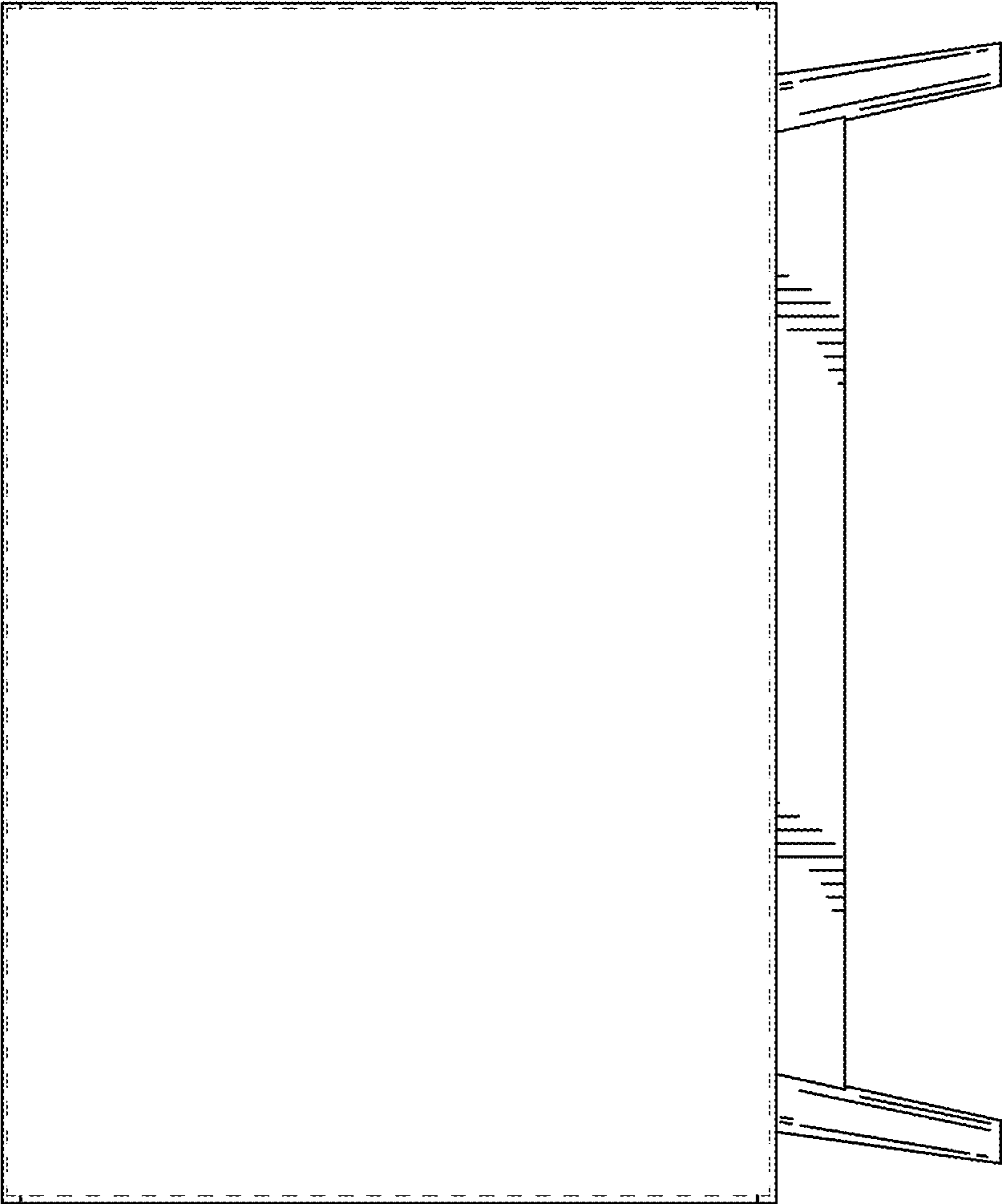

FIG. 3



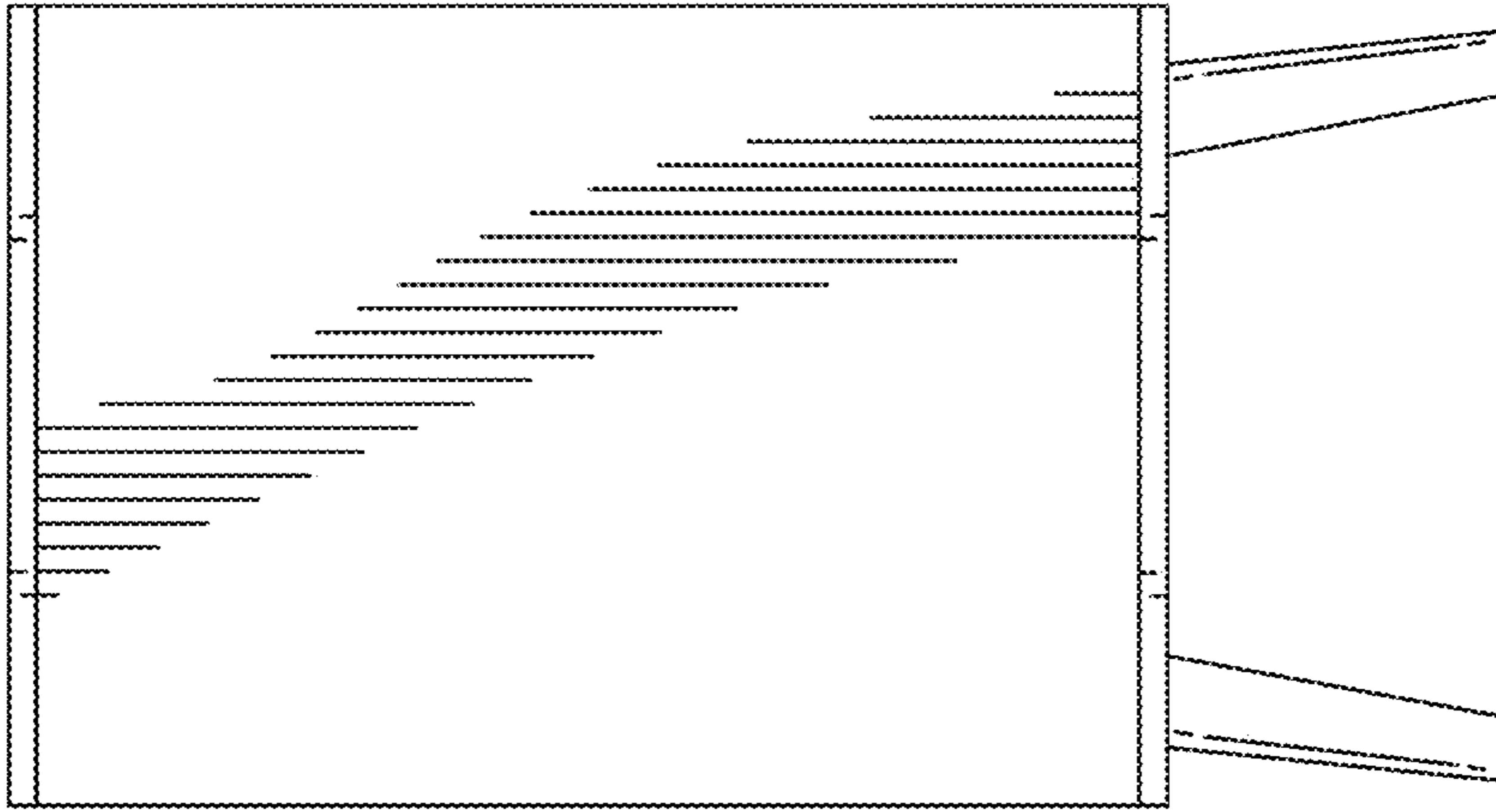

FIG. 5

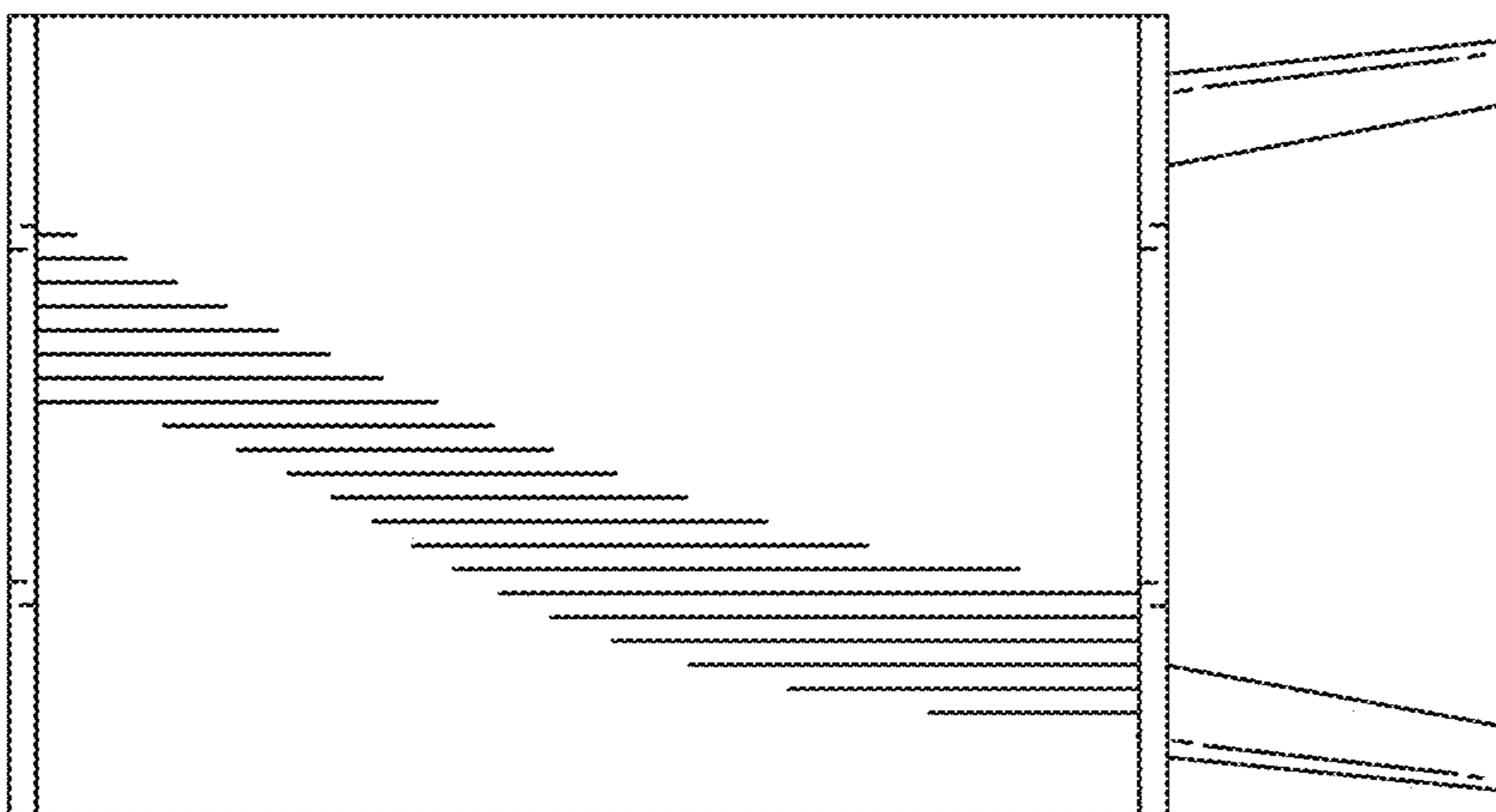

FIG. 4



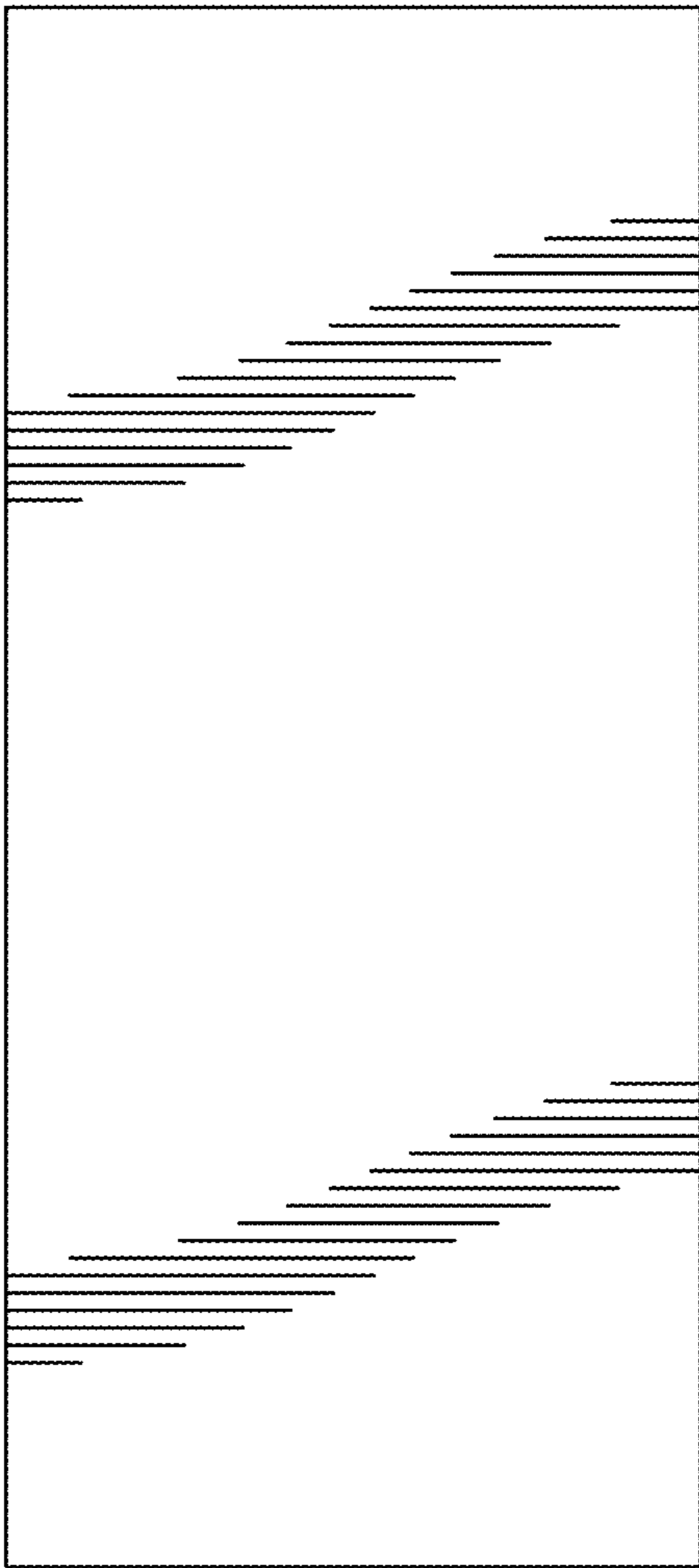

FIG. 6

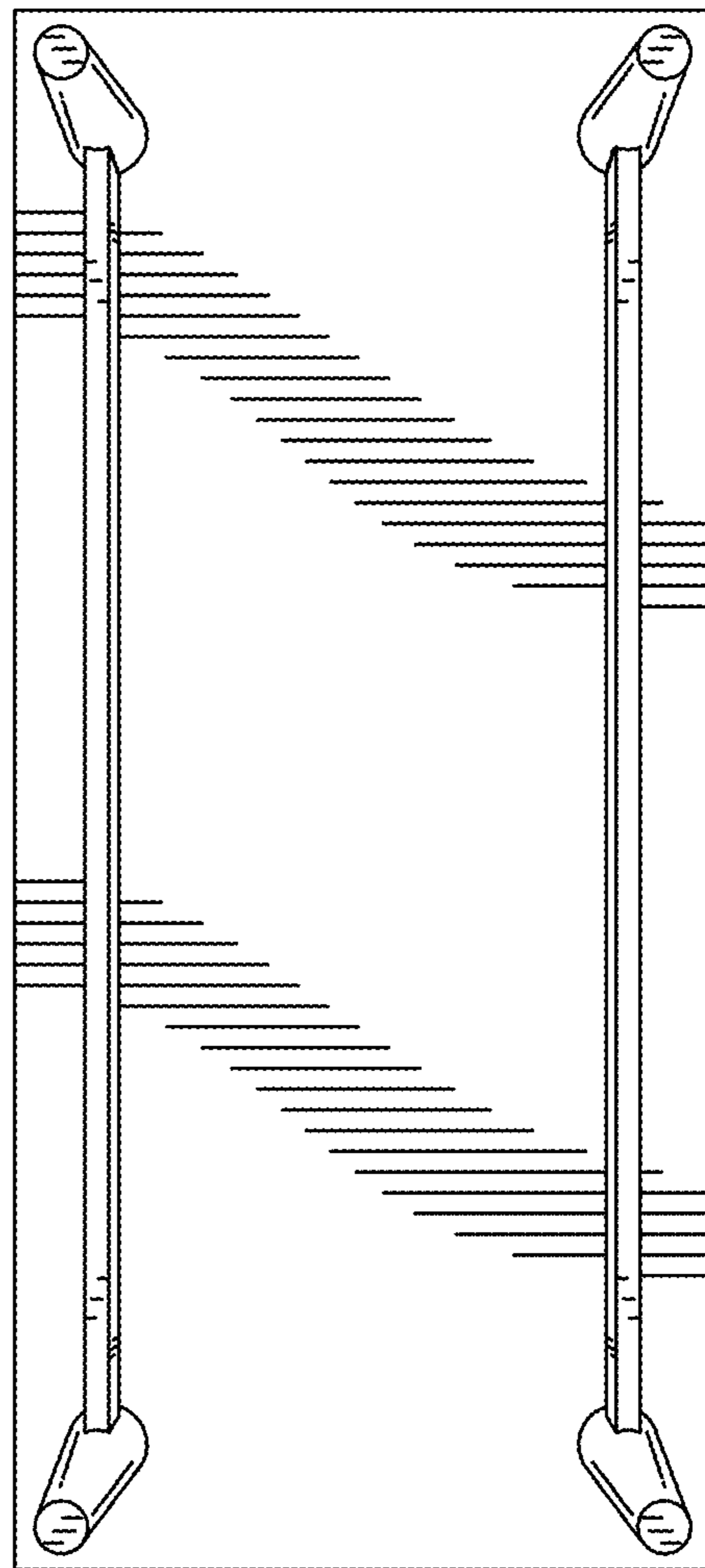

FIG. 7