



US00D988028S

(12) **United States Design Patent** (10) **Patent No.:** **US D988,028 S**
Capone Doumas (45) **Date of Patent:** **** Jun. 6, 2023**

- (54) **SURFBOARD SHELF**
- (71) Applicant: **DEAR RIDE P.C.**, Glyfada (GR)
- (72) Inventor: **Iakovos Capone Doumas**, Glyfada (GR)
- (73) Assignee: **DEAR RIDE P.C.**, Glyfada (GR)
- (**) Term: **15 Years**
- (21) Appl. No.: **29/699,955**
- (22) Filed: **Jul. 30, 2019**

- D608,402 S * 1/2010 Johnsrud D21/769
- D792,931 S * 7/2017 Desberg D21/765
- D796,239 S * 9/2017 Thien-Schoenhofen D6/706
- D838,526 S * 1/2019 Kim D6/574
- D886,671 S * 6/2020 Cheung D12/6
- D940,805 S * 1/2022 Desberg D21/765

OTHER PUBLICATIONS

Dean Miller Surf Bedding, Shortboard Surfboard Wall Shelf—Sep. 10, 2010, www.amazon.com, https://www.deanmillerprints.com/Surfboard-Wall-Shelf-p/surfboard-wall-shelf.htm, 2 pages, retrieved May 21, 2022 (Year: 2010).*

* cited by examiner

Primary Examiner — Kelley A Donnelly
Assistant Examiner — Mark Booker
(74) *Attorney, Agent, or Firm* — Amster, Rothstein & Ebenstein LLP

Related U.S. Application Data

- (63) Continuation-in-part of application No. 35/503,599, filed on Feb. 24, 2017 (U.S. filing date under 35 U.S.C. 384), and having an international filing date of Feb. 24, 2017, now abandoned.
- (51) **LOC (14) Cl.** **06-04**
- (52) **U.S. Cl.**
USPC **D6/574**
- (58) **Field of Classification Search**
USPC D6/563, 320–324, 574, 705.1; D7/698; D12/6; D21/760, 761, 765, 766, 801, D21/803, 769; 108/28–29, 152; 211/13.1, 42, 86.01, 88.01, 90.01, 90.03, 211/126.1, 134, 153; 248/205.3, 235, 248/243, 247, 250
CPC A47B 43/00; A47B 43/04; A47B 47/0066; A47B 47/04; A47B 63/00; A47B 69/00; A47B 71/00; B63B 35/73; B63B 35/79
See application file for complete search history.

CLAIM

(57) The ornamental design for a surfboard shelf, as shown and described.

DESCRIPTION

FIG. 1 is a bottom left perspective view of a first embodiment of a surfboard shelf showing the new design; FIG. 2 is a top left perspective view thereof; FIG. 3 is a top, left, front perspective view thereof; FIG. 4 is a bottom, left, front perspective view thereof; FIG. 5 is a top plan view thereof; FIG. 6 is a bottom plan view thereof; FIG. 7 is a right view thereof; FIG. 8 is a left view thereof; FIG. 9 is a rear view thereof; and, FIG. 10 is a front view thereof. My design includes a second embodiment of a surfboard shelf that comprises a mirror image of the embodiment depicted.

1 Claim, 6 Drawing Sheets

- (56) **References Cited**
U.S. PATENT DOCUMENTS
D373,699 S * 9/1996 Moon D6/574
D428,459 S * 7/2000 Broz D21/769
D587,936 S * 3/2009 Johnson D6/563

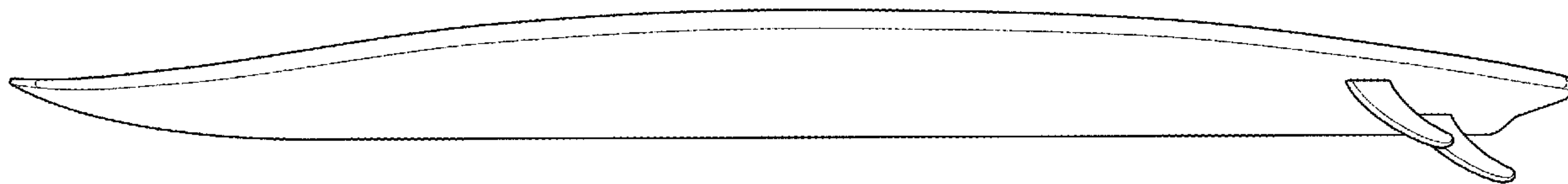

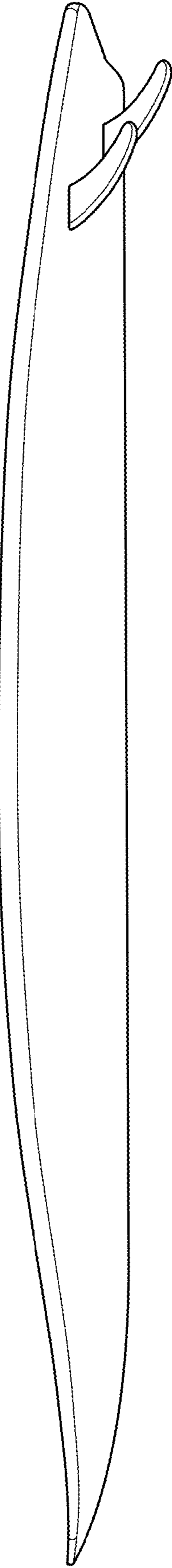

FIG. 1

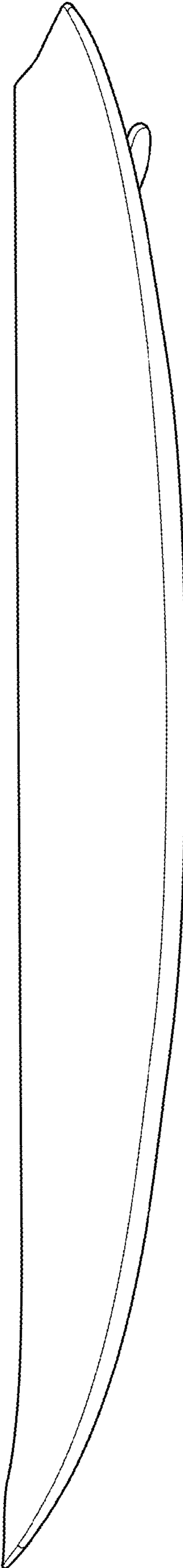

FIG. 2

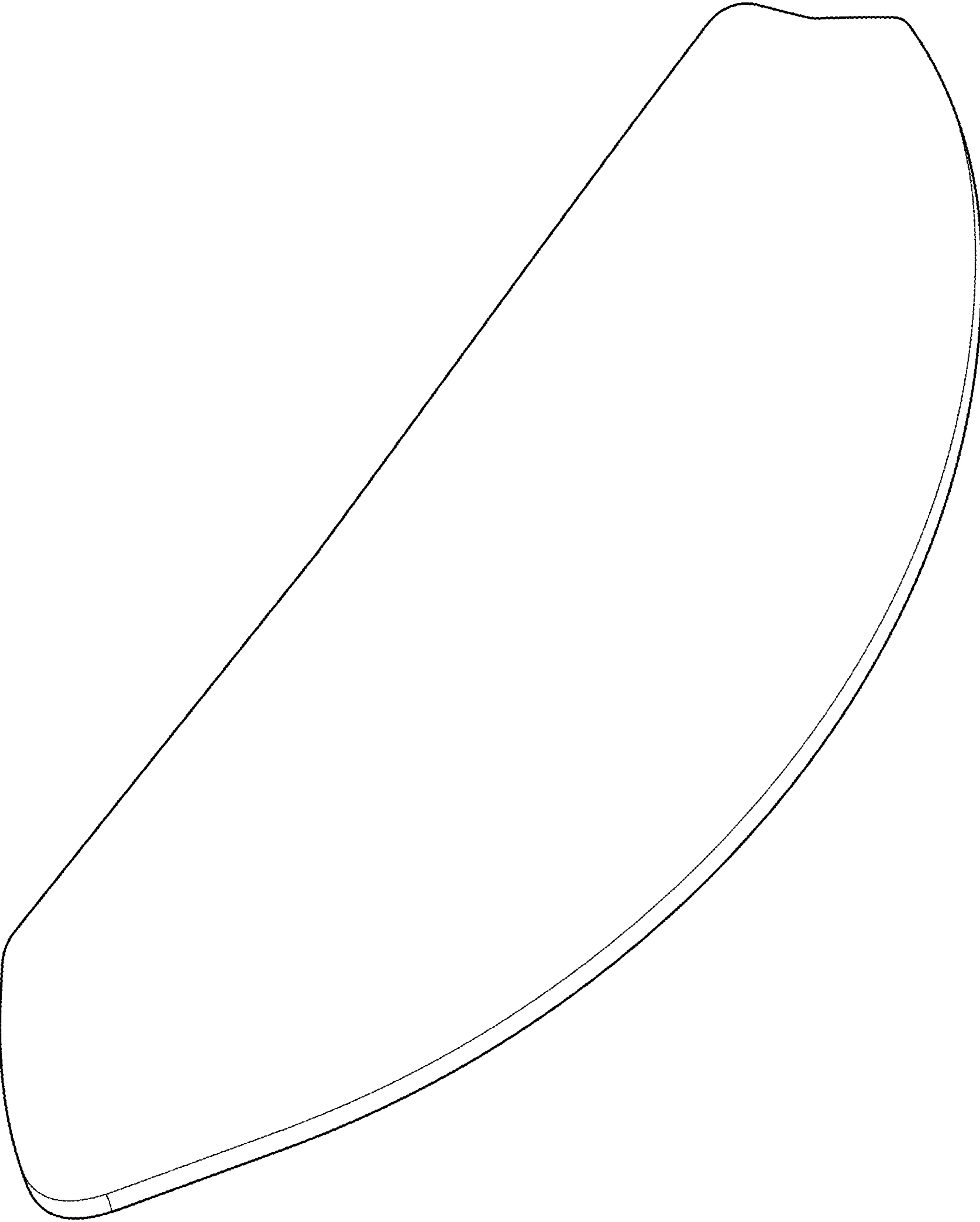

FIG. 3

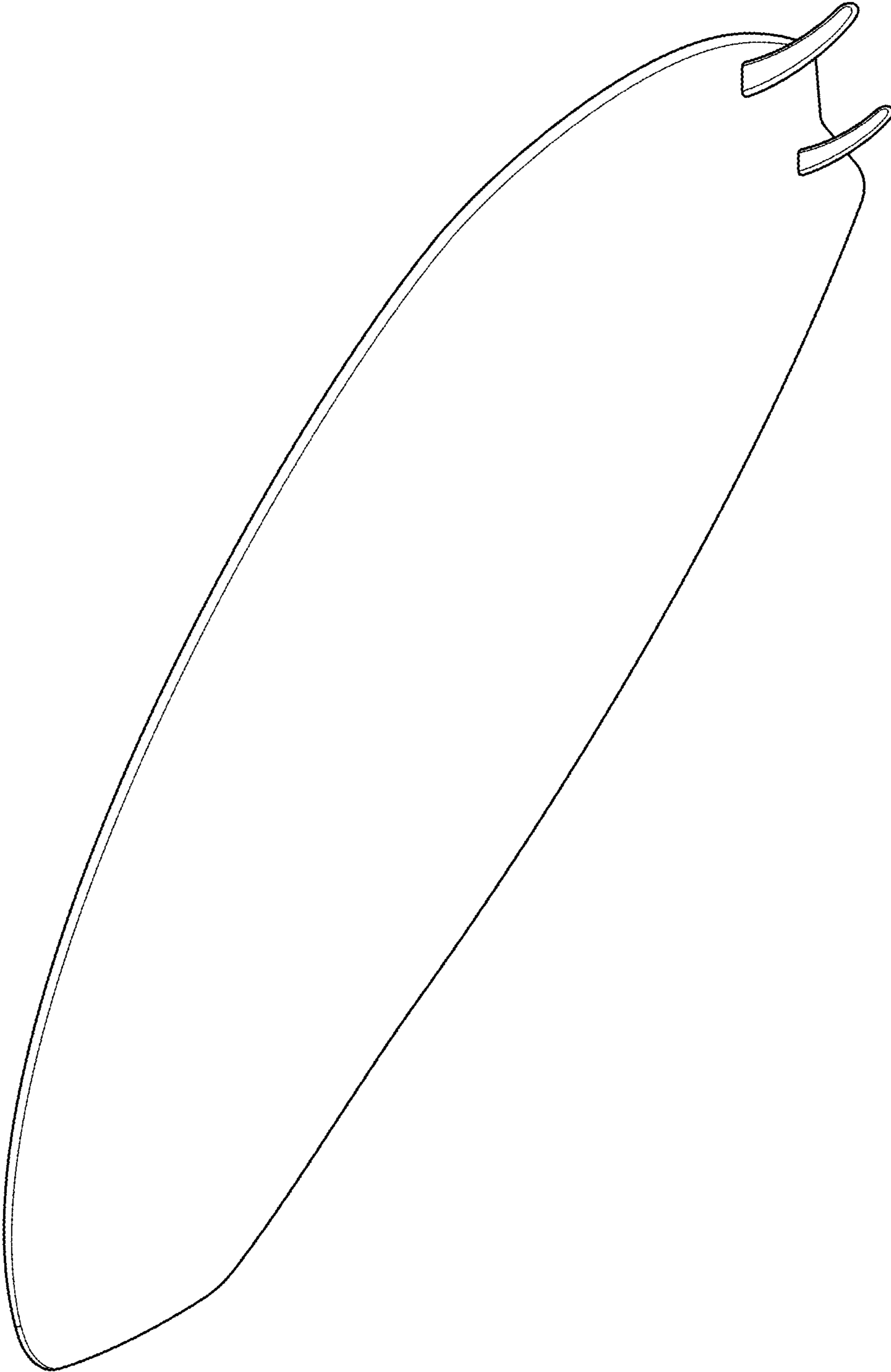

FIG. 4

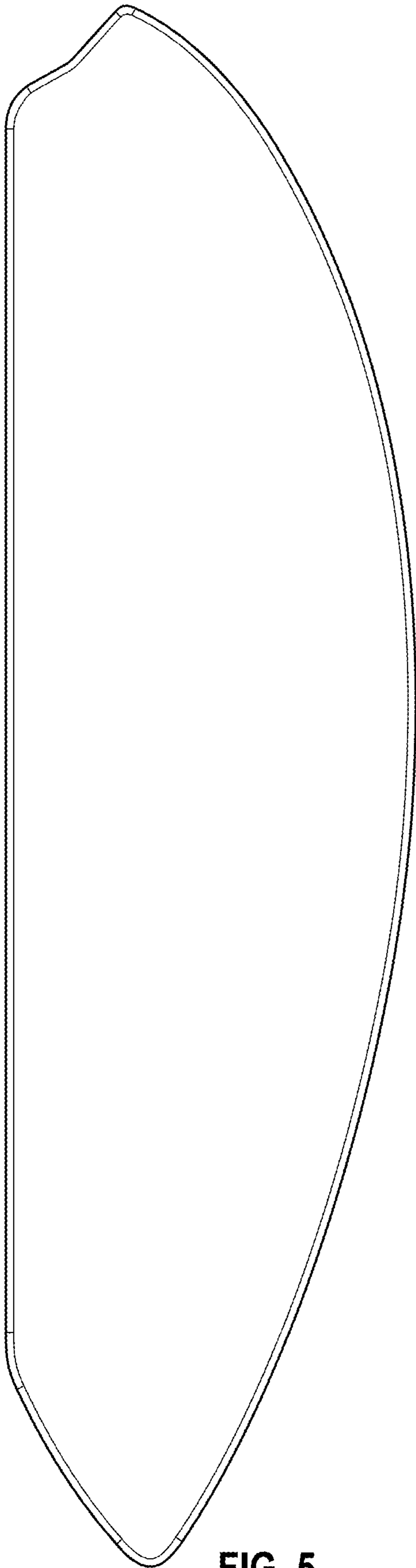

FIG. 5

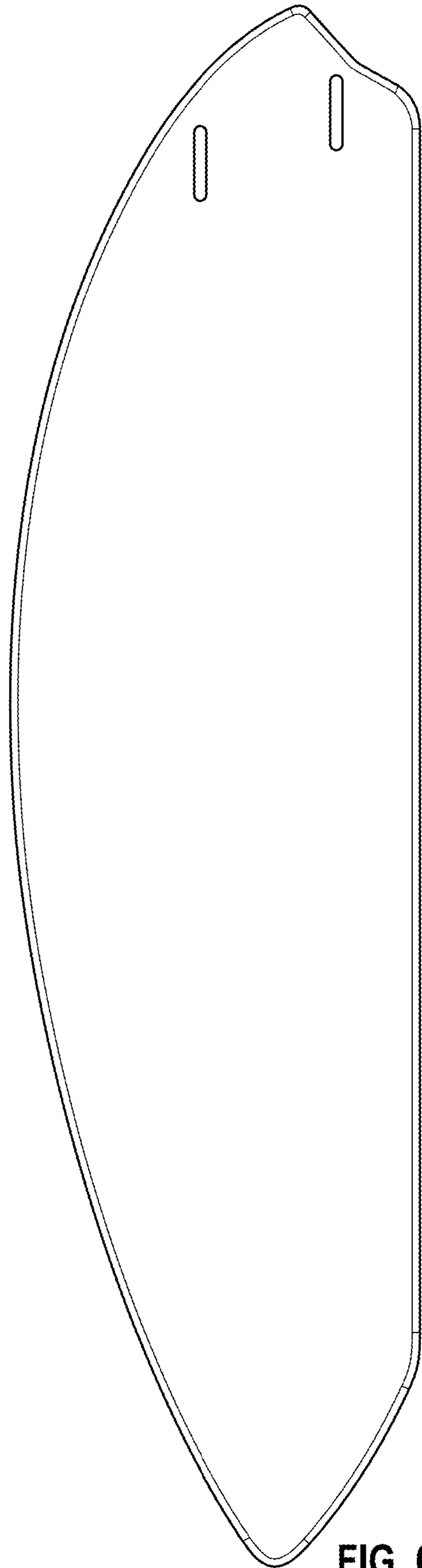

FIG. 6

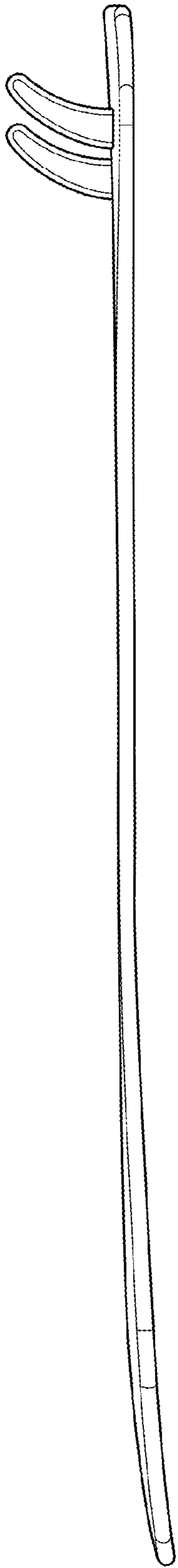

FIG. 7

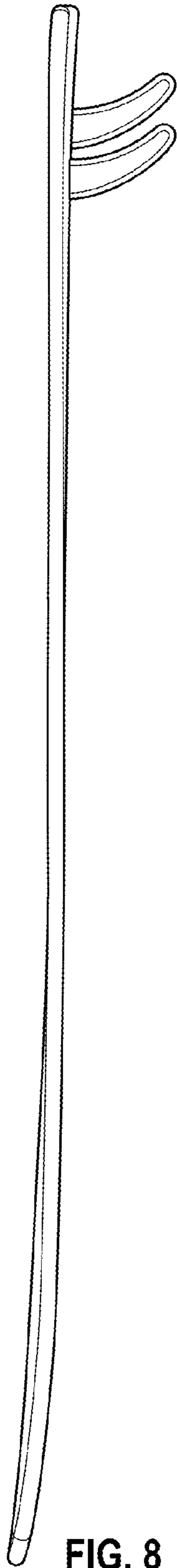

FIG. 8

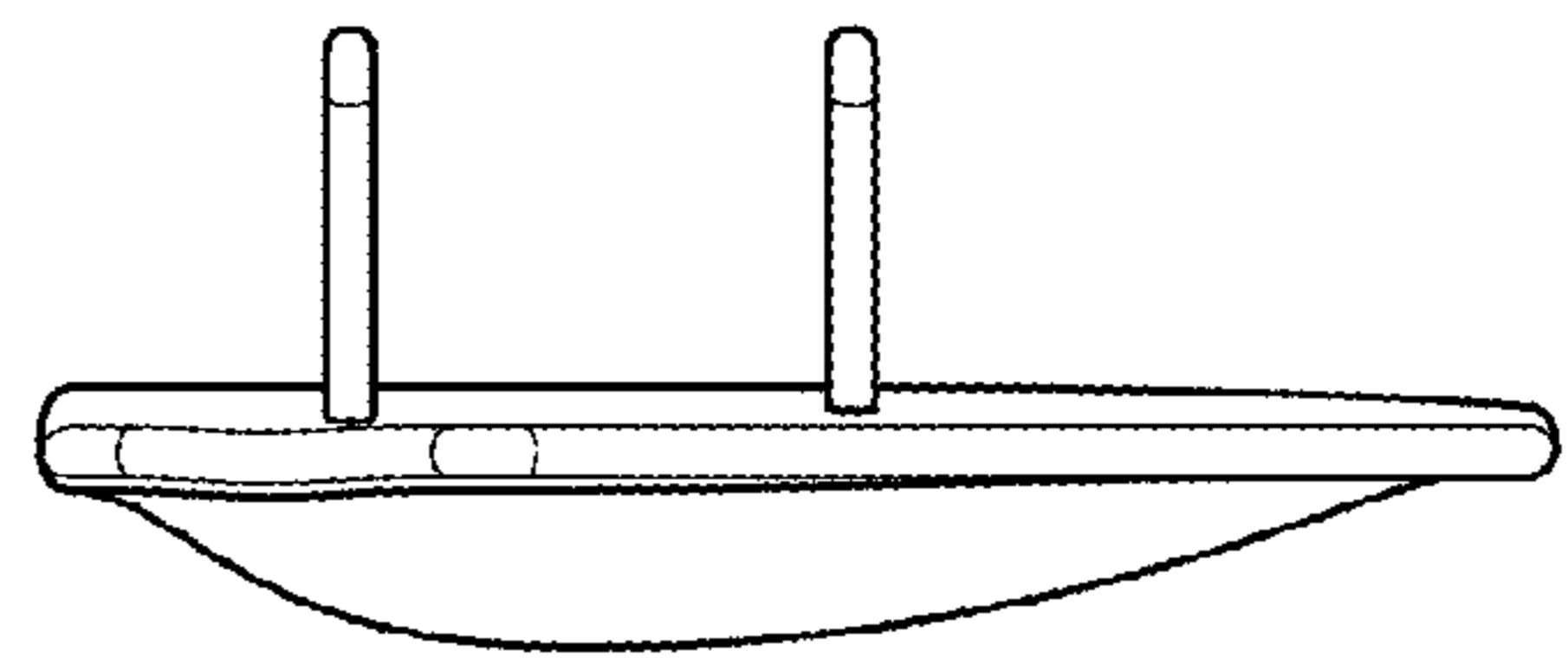

FIG. 9

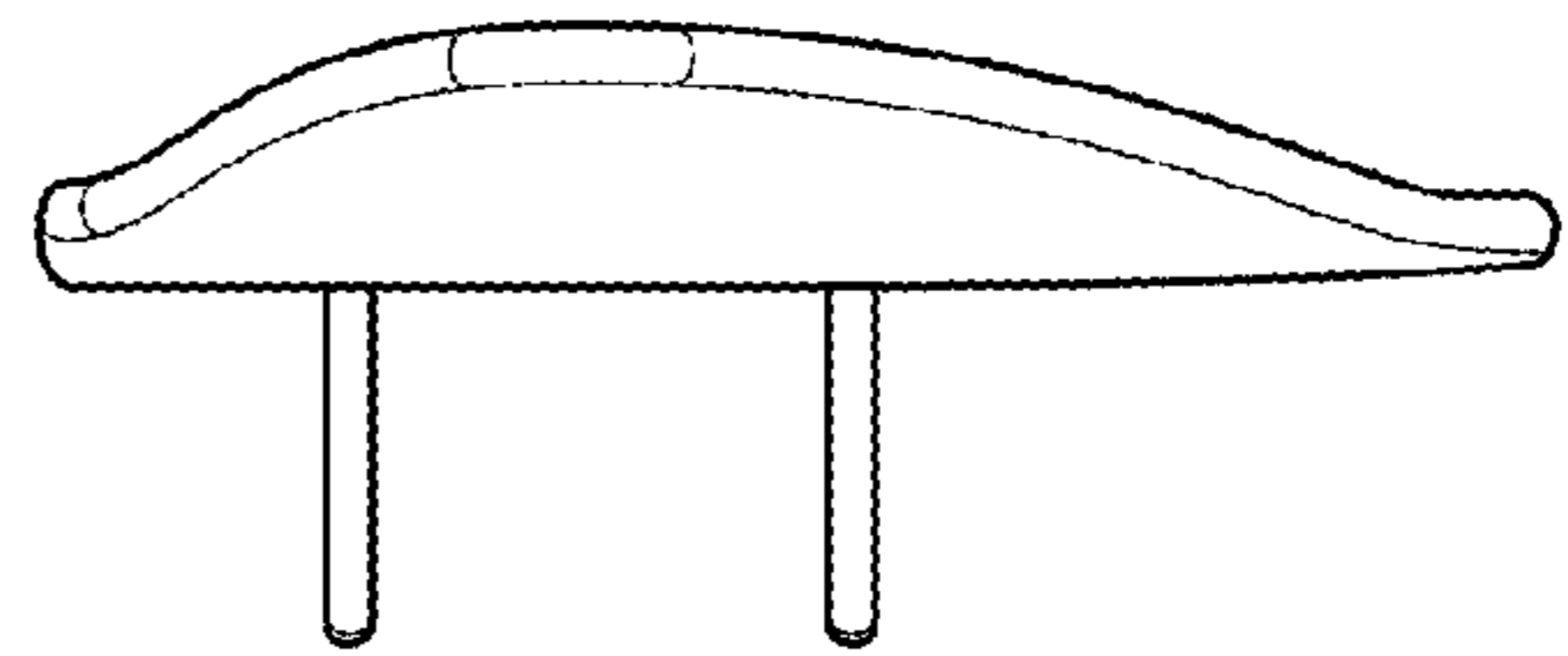

FIG. 10