



US00D988018S

(12) **United States Design Patent** (10) **Patent No.:** **US D988,018 S**  
**Kim** (45) **Date of Patent:** **\*\* Jun. 6, 2023**

- (54) **BICYCLE SADDLE**
- (71) Applicant: **HUAN CO., LTD.**, Chuncheon-si (KR)
- (72) Inventor: **Yong Joo Kim**, Chuncheon-si (KR)
- (73) Assignee: **Huan Co., Ltd.**
- (\*\*) Term: **15 Years**
- (21) Appl. No.: **29/836,013**
- (22) Filed: **Apr. 22, 2022**

D434,235 S 11/2000 Kuipers  
 6,149,230 A 11/2000 Bontrager  
 6,224,151 B1 5/2001 McMullen, Jr.  
 (Continued)

**FOREIGN PATENT DOCUMENTS**

EP 1813514 A2 8/2007  
 KR 2019990039142 U 11/1999  
 (Continued)

**OTHER PUBLICATIONS**

PCT International Search Report and Written Opinion for PCT International Application No. PCT/KR2020/008615 dated Sep. 25, 2020, 9 pages, including English translation of the PCT International Search Report.  
 (Continued)

*Primary Examiner* — Michelle E. Wilson  
*Assistant Examiner* — Clese Moore, Jr.  
 (74) *Attorney, Agent, or Firm* — Lewis Roca Rothgerber Christie LLP

**Related U.S. Application Data**

- (63) Continuation of application No. 29/762,034, filed on Dec. 14, 2020, now abandoned.
- (51) **LOC (14) Cl.** ..... **06-01**
- (52) **U.S. Cl.**  
USPC ..... **D6/354**
- (58) **Field of Classification Search**  
USPC ..... D6/354, 340; D12/114, 119, 111, 110  
CPC ..... B62J 1/00; B62J 1/002; B62J 1/005; B62J 1/007; B62J 1/26  
See application file for complete search history.

(57) **CLAIM**  
 I claim the ornamental design for a bicycle saddle, as shown.

**DESCRIPTION**

FIG. 1 is a top perspective view of a bicycle saddle of my new design;  
 FIG. 2 is a front view thereof;  
 FIG. 3 is a rear view thereof;  
 FIG. 4 is a left-side view thereof;  
 FIG. 5 is a right-side view thereof;  
 FIG. 6 is a top plan view thereof;  
 FIG. 7 is a bottom plan view thereof; and,  
 FIG. 8 is a bottom perspective view thereof.  
 The gray shading shown is intended to represent the contours of the design and is not representative of any particular color.

**References Cited**

**U.S. PATENT DOCUMENTS**

- 5,873,626 A 2/1999 Katz
- D407,910 S \* 4/1999 Terry ..... D6/354
- D416,394 S \* 11/1999 Minkow ..... B62J 1/00  
D6/354
- D416,695 S 11/1999 Minkow et al.
- D429,573 S \* 8/2000 Bontrager ..... D6/354
- D429,907 S \* 8/2000 Minkow ..... D6/354
- 6,106,059 A 8/2000 Minkow et al.
- D430,413 S 9/2000 Minkow et al.
- D431,919 S 10/2000 Bontrager
- D431,920 S 10/2000 Goldstein
- D433,827 S 11/2000 Kuipers

**1 Claim, 5 Drawing Sheets**

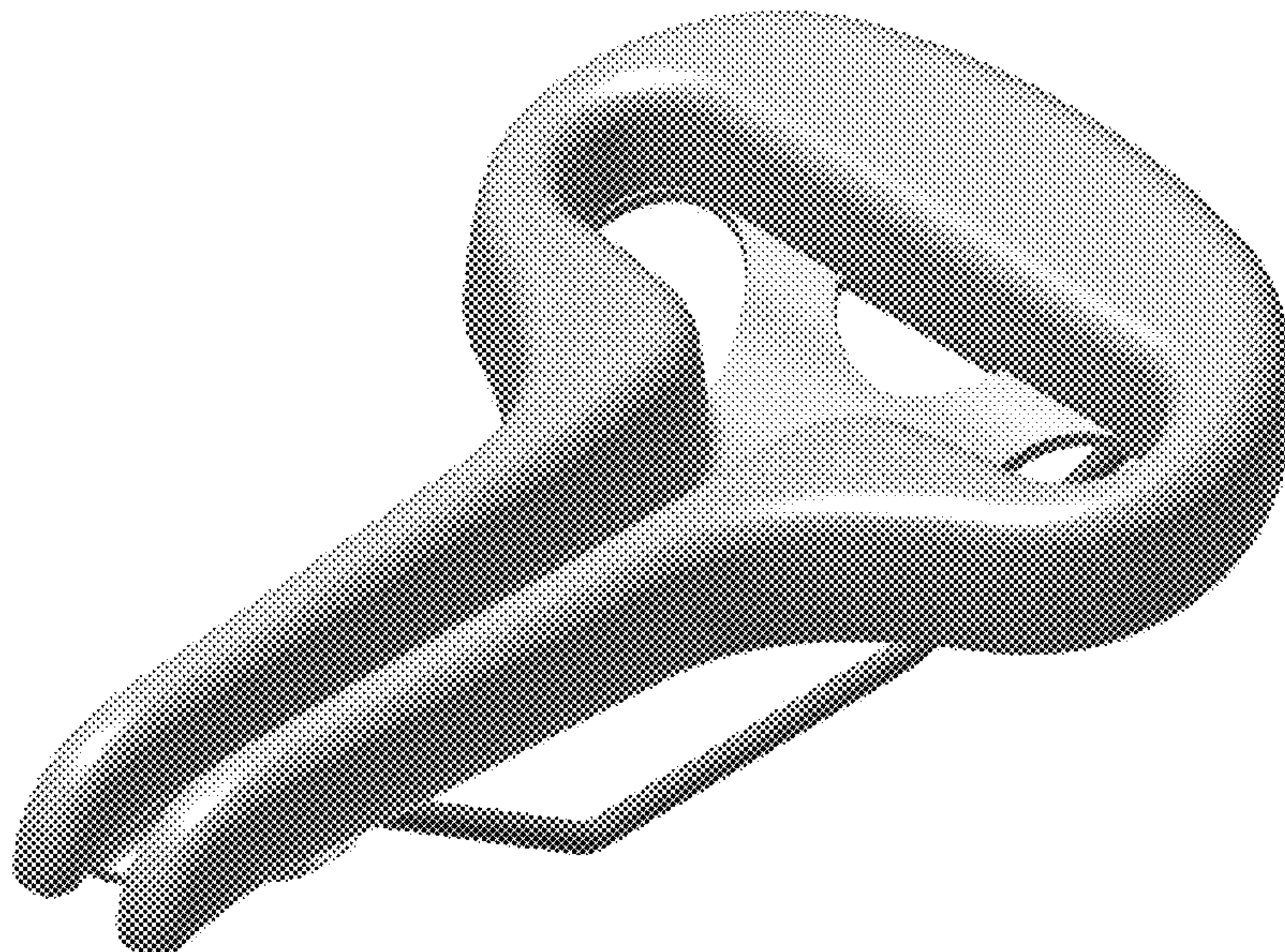

(56)

References Cited

U.S. PATENT DOCUMENTS

D454,258 S \* 3/2002 Yates ..... B62J 1/005  
D6/354  
D456,157 S \* 4/2002 Yates ..... B62J 1/00  
D6/354  
6,402,236 B1 6/2002 Yates  
D590,160 S 4/2009 Hung  
D620,721 S \* 8/2010 Kenney ..... D6/354  
D684,781 S \* 6/2013 Toll ..... B62J 1/00  
D6/354  
D707,046 S 6/2014 Huang  
D716,571 S \* 11/2014 Huan ..... D6/354  
D739,153 S \* 9/2015 Kurata ..... D6/354  
9,233,725 B2 1/2016 Marcel  
D752,888 S \* 4/2016 Huan ..... B62J 1/005  
D6/354  
D754,449 S 4/2016 Lam  
D756,675 S 5/2016 Toll  
D760,507 S 7/2016 Marcel  
D764,820 S 8/2016 Toll et al.  
D764,821 S 8/2016 Toll  
D769,007 S 10/2016 Toll  
D769,008 S 10/2016 Toll  
D774,790 S 12/2016 Toll  
D778,079 S \* 2/2017 Porter ..... D6/354  
D784,033 S \* 4/2017 Li ..... D6/354  
D786,573 S 5/2017 Toll  
D787,210 S 5/2017 Schwary  
D787,211 S 5/2017 Schwary  
D787,212 S 5/2017 Schwary  
9,637,193 B1 5/2017 Porter et al.  
D802,947 S 11/2017 Toll  
D802,948 S 11/2017 Toll  
D846,896 S 4/2019 Hain  
D846,897 S 4/2019 Toll  
D846,898 S \* 4/2019 Kenney ..... B62J 1/00  
D6/354  
D846,899 S 4/2019 Toll

D847,522 S \* 5/2019 Pruitt ..... B62J 1/00  
D6/354  
D875,411 S \* 2/2020 Bigolin ..... D6/354  
D880,880 S \* 4/2020 Toll ..... B62J 1/00  
D6/354  
D887,731 S 6/2020 Kim  
D889,862 S \* 7/2020 Toll ..... D6/354  
D903,348 S 12/2020 Toll  
D904,049 S 12/2020 Toll  
D905,982 S 12/2020 Petty  
D919,313 S 5/2021 Kim  
2007/0200399 A1 8/2007 Riondato  
2009/0079237 A1 3/2009 Riondato  
2013/0313870 A1 \* 11/2013 Riondato ..... B62J 1/18  
297/202  
2014/0145479 A1 5/2014 Li  
2015/0175228 A1 \* 6/2015 Yu ..... B62J 1/002  
297/202  
2016/0137245 A1 5/2016 Schiavon et al.  
2016/0368554 A1 12/2016 Rizzato et al.  
2017/0274950 A1 9/2017 Holt et al.  
2018/0057090 A1 \* 3/2018 Marui ..... B62J 1/18

FOREIGN PATENT DOCUMENTS

KR 1020100116740 A 11/2010  
KR 3009508390000 3/2018  
KR 3009715730001 8/2018  
KR 3009715730002 8/2018  
KR 3009715730003 2/2019  
KR 102109534 B1 5/2020

OTHER PUBLICATIONS

Design U.S. Appl. No. 29/762,034, filed Dec. 14, 2020 by the Applicant, "Huan Co., Ltd." entitled "Bicycle Saddle" (7 pages).  
Utility U.S. Appl. No. 17/619,926, filed Dec. 16, 2021 by the Applicant, "Huang Co., LTD." entitled "Bicycle Saddle" (English-language translation only) (17 pages).

\* cited by examiner



FIG. 1

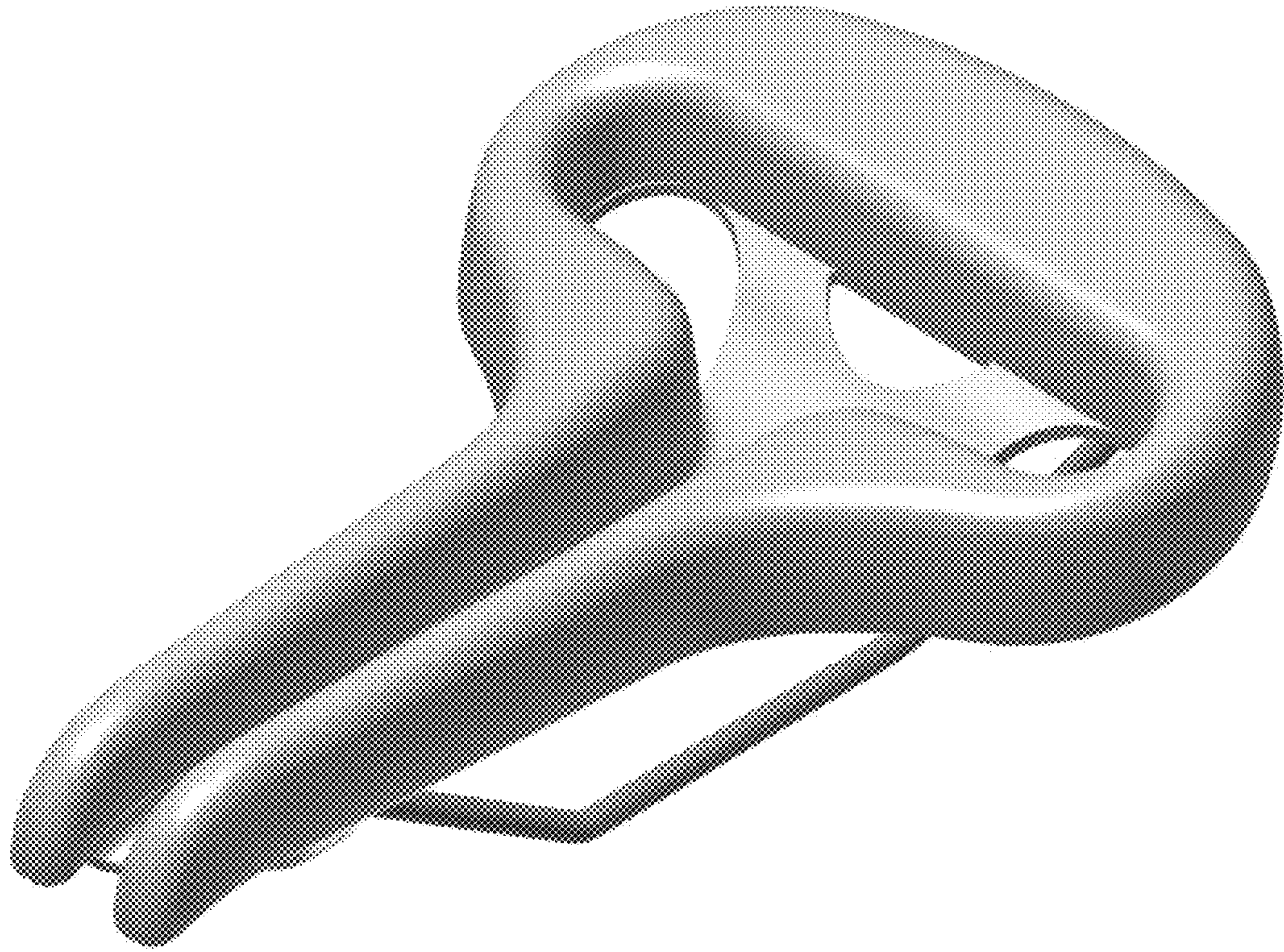

FIG. 2

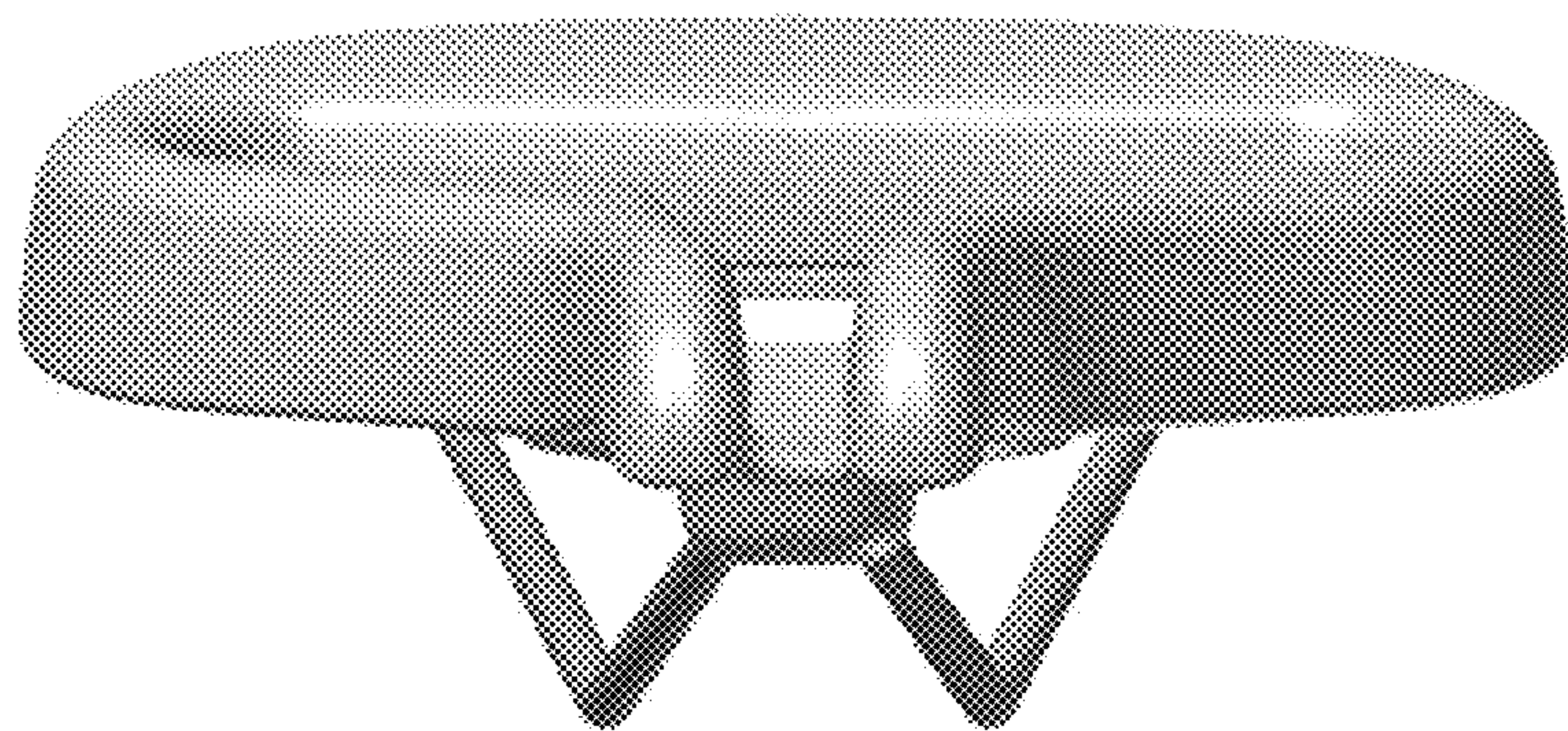



FIG. 3

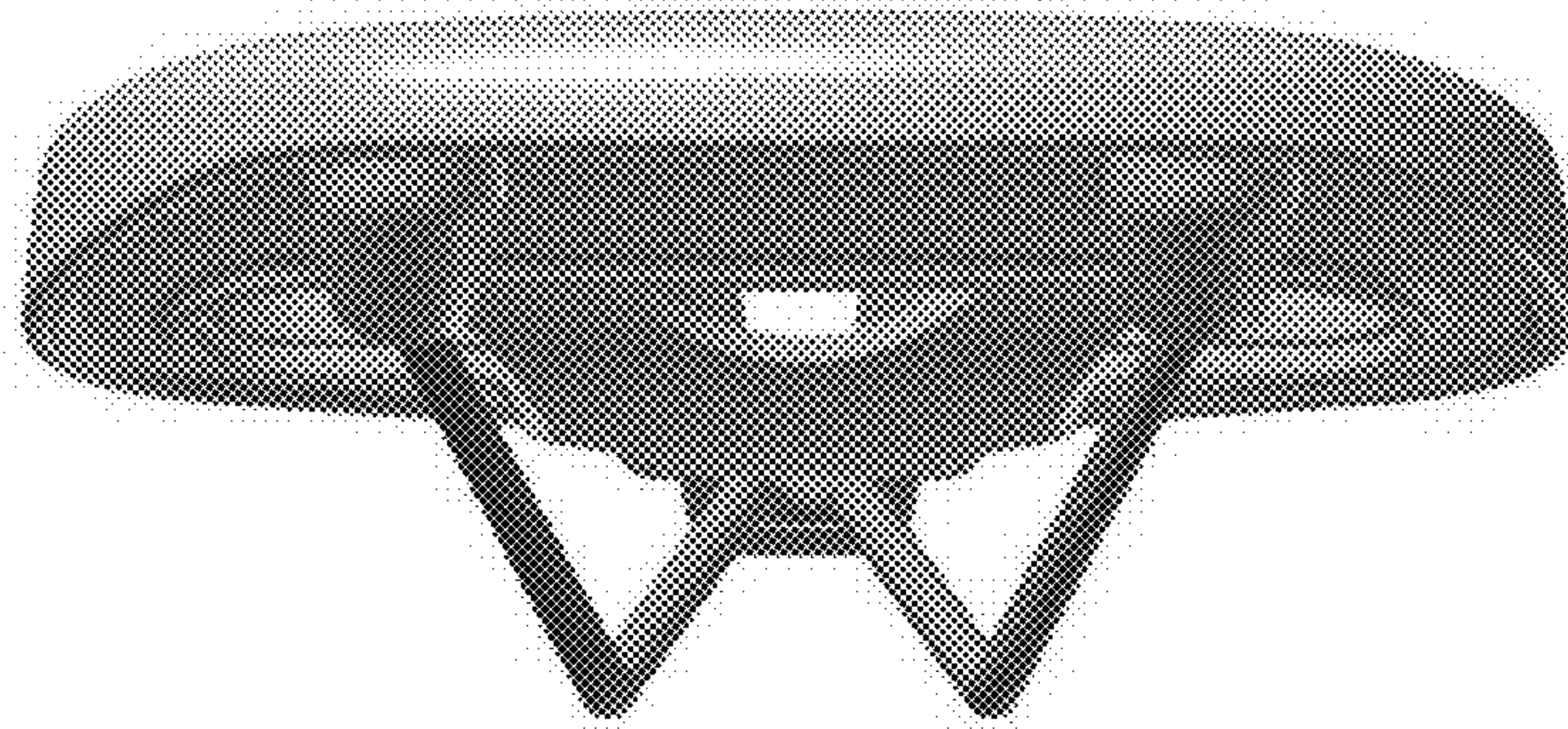

FIG. 4

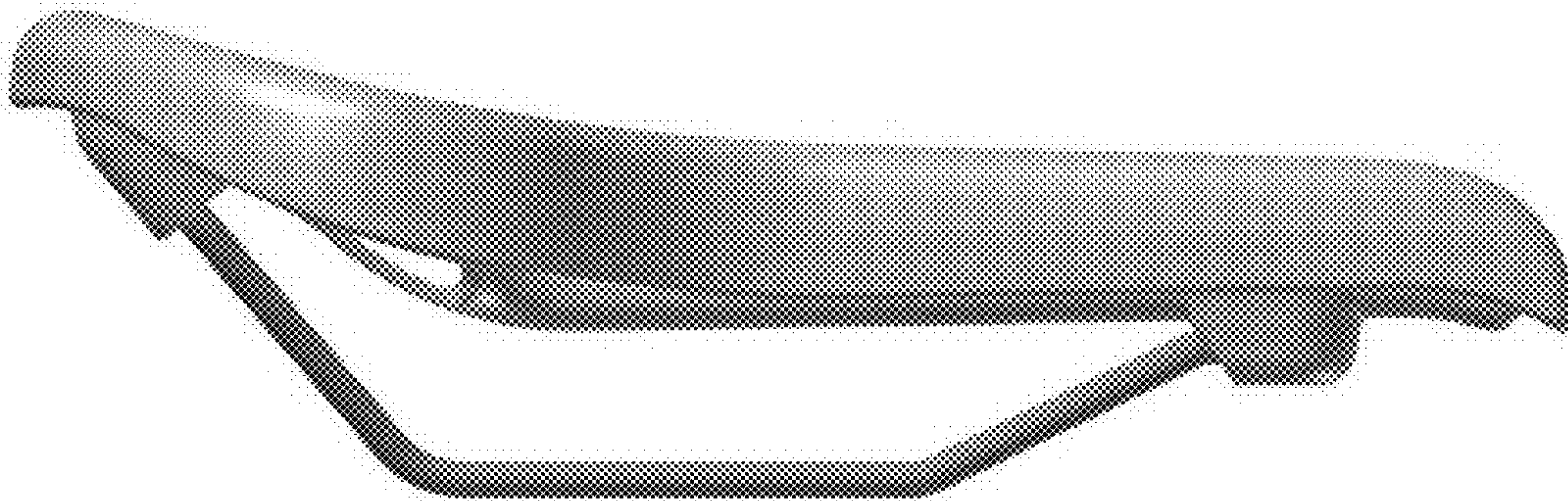

FIG. 5

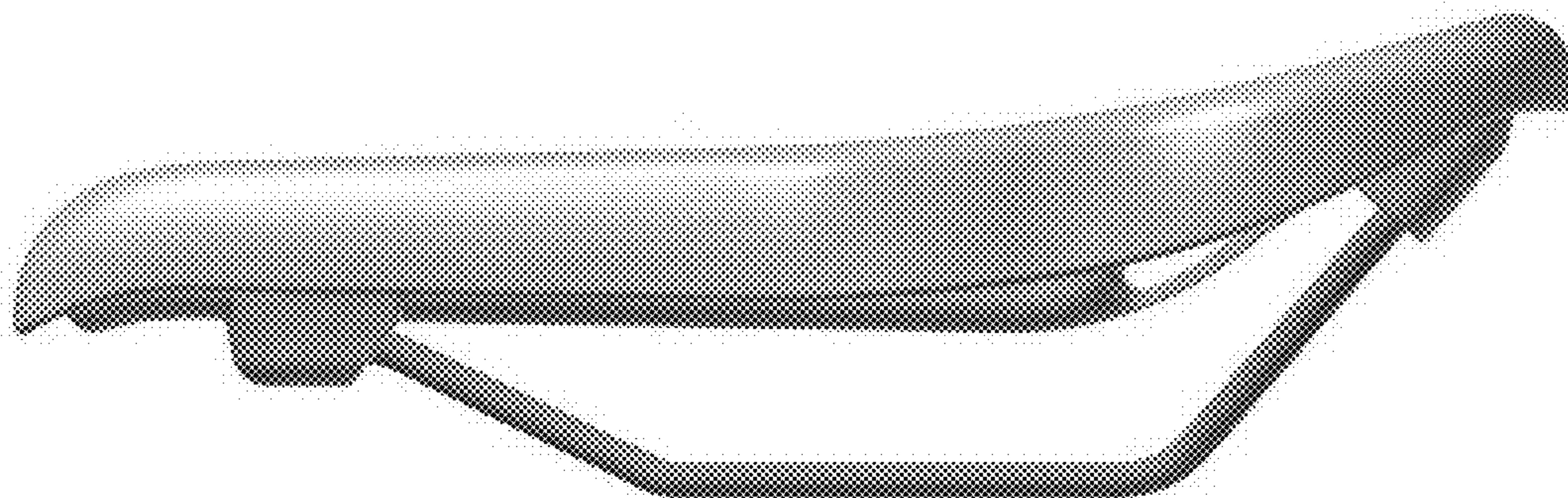

FIG. 6

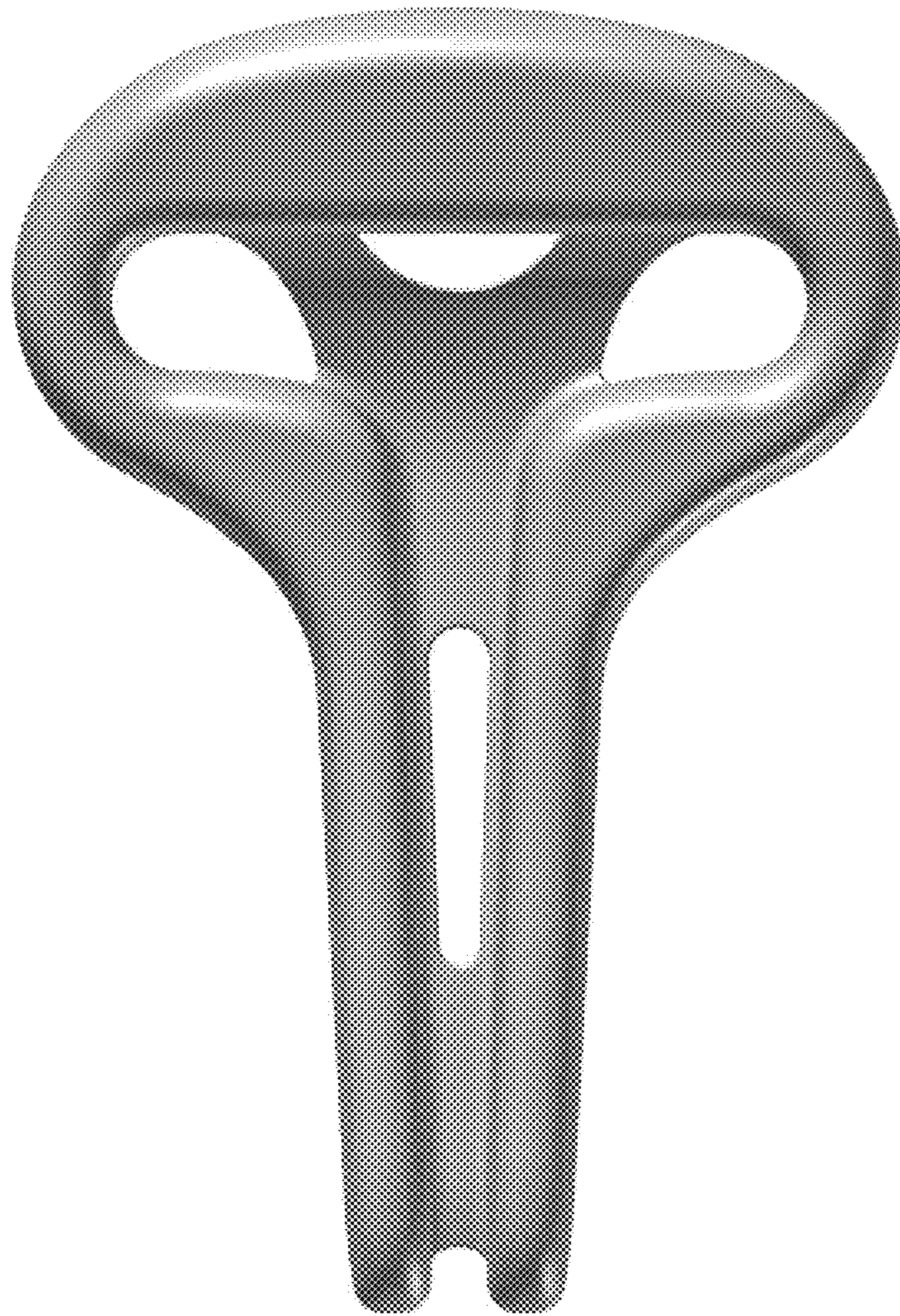



FIG. 7

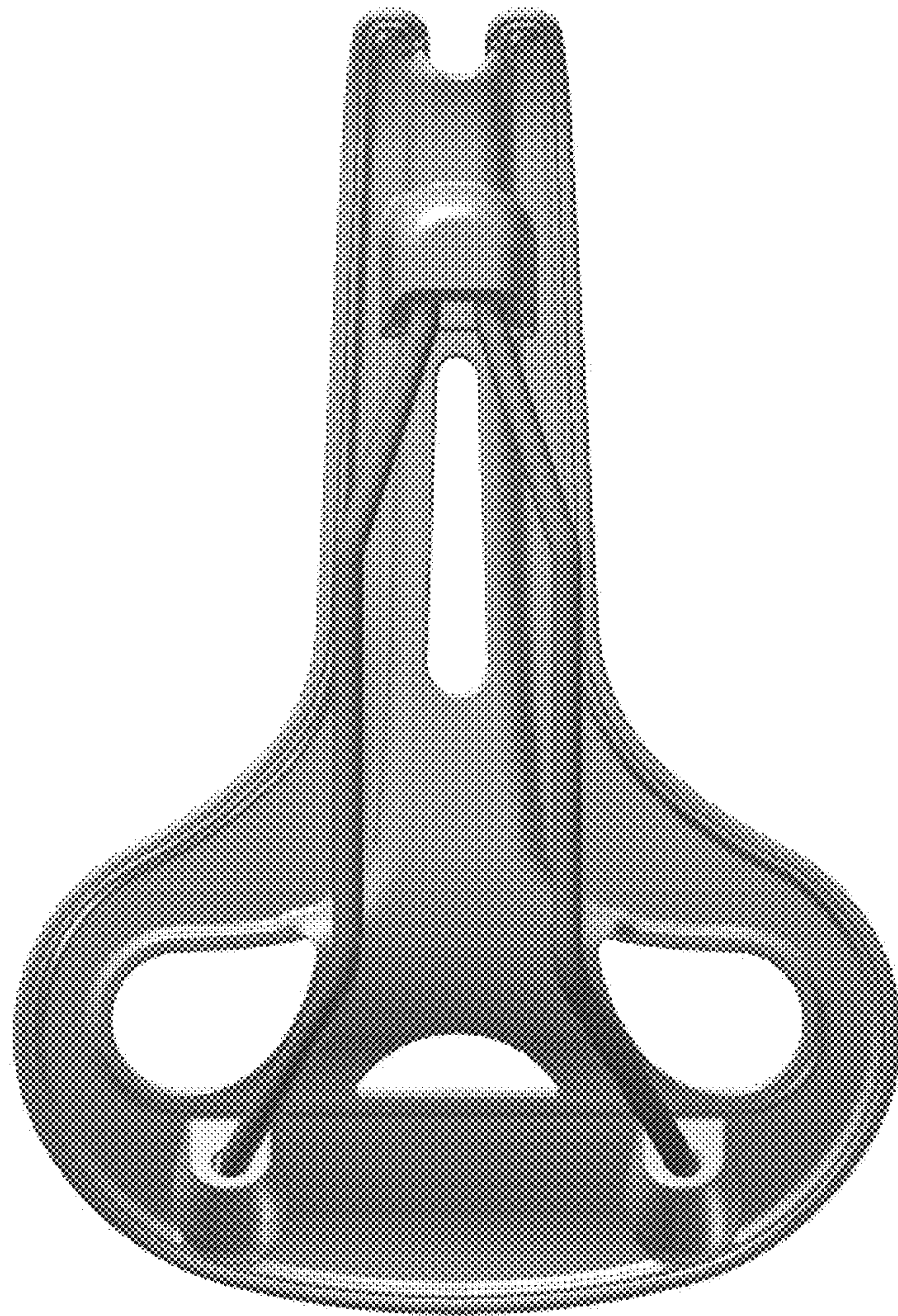

FIG. 8

