



US00D987995S

(12) **United States Design Patent**  
**Zeng**

(10) **Patent No.:** **US D987,995 S**

(45) **Date of Patent:** **\*\* Jun. 6, 2023**

(54) **STORAGE BAG**

(71) Applicant: **Jingjing Zeng**, Shenzhen (CN)

(72) Inventor: **Jingjing Zeng**, Shenzhen (CN)

(\*\*) Term: **15 Years**

(21) Appl. No.: **29/847,236**

(22) Filed: **Jul. 22, 2022**

(51) **LOC (14) Cl.** ..... **03-01**

(52) **U.S. Cl.**

USPC ..... **D3/246**

(58) **Field of Classification Search**

USPC ..... D3/231–233, 243–246, 249–253, 263,  
D3/268–267, 294, 318, 905, 217, 289,  
D3/279, 276, 273, 218, 282, 247, 301,  
D3/201, 283, 303, 216, 255, 295, 274,  
D3/265, 900, 302, 304, 287, 284, 299,  
D3/254, 290, 226, 321, 903, 203.1, 205,  
D3/281, 26, 320, 262, 901, 260, 319, 206,  
D3/272, 315, 285, 291, 215, 204, 238,  
D3/292, 327, 270, 264, 278, 203.3, 313,  
D3/212, 902, 234, 307, 27, 297, 323, 202,  
D3/203.2, 314, 219, 221, 298, 261, 32,  
D3/904, 288, 312, 230, 300, 271.2, 228,  
D3/28, 208, 266, 229, 256, 296, 293, 275,  
D3/305, 306, 20, 271.4, 248, 257, 310,  
D3/203.5, 235, 258, 271.1, 308, 11,  
D3/271.5, 309, 311, 317, 324, 271.3, 3,  
D3/203.6, 224; 190/18 A, 115, 109, 110,  
190/127, 111, 107, 102, 108, 103, 119,

(Continued)

(56) **References Cited**

**U.S. PATENT DOCUMENTS**

D711,096 S \* 8/2014 Hanna ..... D3/232  
D763,570 S \* 8/2016 Potts ..... D3/232

(Continued)

*Primary Examiner* — Amy C Wierenga

*Assistant Examiner* — Andrea Marie McKay

(74) *Attorney, Agent, or Firm* — Daniel M. Cohn;  
Howard M. Cohn

(57) **CLAIM**

The ornamental design for a storage bag, as shown and described.

**DESCRIPTION**

FIG. 1 is a perspective view of a storage bag showing my new design;

FIG. 2 is another perspective view thereof;

FIG. 3 is a front elevational view thereof;

FIG. 4 is a rear elevational view thereof;

FIG. 5 is a left side elevational view thereof;

FIG. 6 is a right side elevational view thereof;

FIG. 7 is a top plan view thereof;

FIG. 8 is a bottom plan view thereof;

FIG. 9 is an enlarged detail view of the selected portion 9 shown in FIG. 1;

FIG. 10 is an enlarged detail view of the selected portion 10 shown in FIG. 2;

FIG. 11 is an enlarged detail view of the selected portion 11 shown in FIG. 3;

FIG. 12 is an enlarged detail view of the selected portion 12 shown in FIG. 3;

FIG. 13 is an enlarged detail view of the selected portion 13 shown in FIG. 4; and,

FIG. 14 is an enlarged detail view of the selected portion 14 shown in FIG. 4.

The long thin dash-dash broken lines in the drawings depict portions of the storage bag that form no part of the claimed design.

The short thick dash-dash broken lines depict stitching and form no part of the claimed design.

The dash-dot broken lines shown in FIGS. 1-4 and FIGS. 9-14 indicate cutoff boundaries for enlarged detail portion views and form no part of the claim.

**1 Claim, 14 Drawing Sheets**

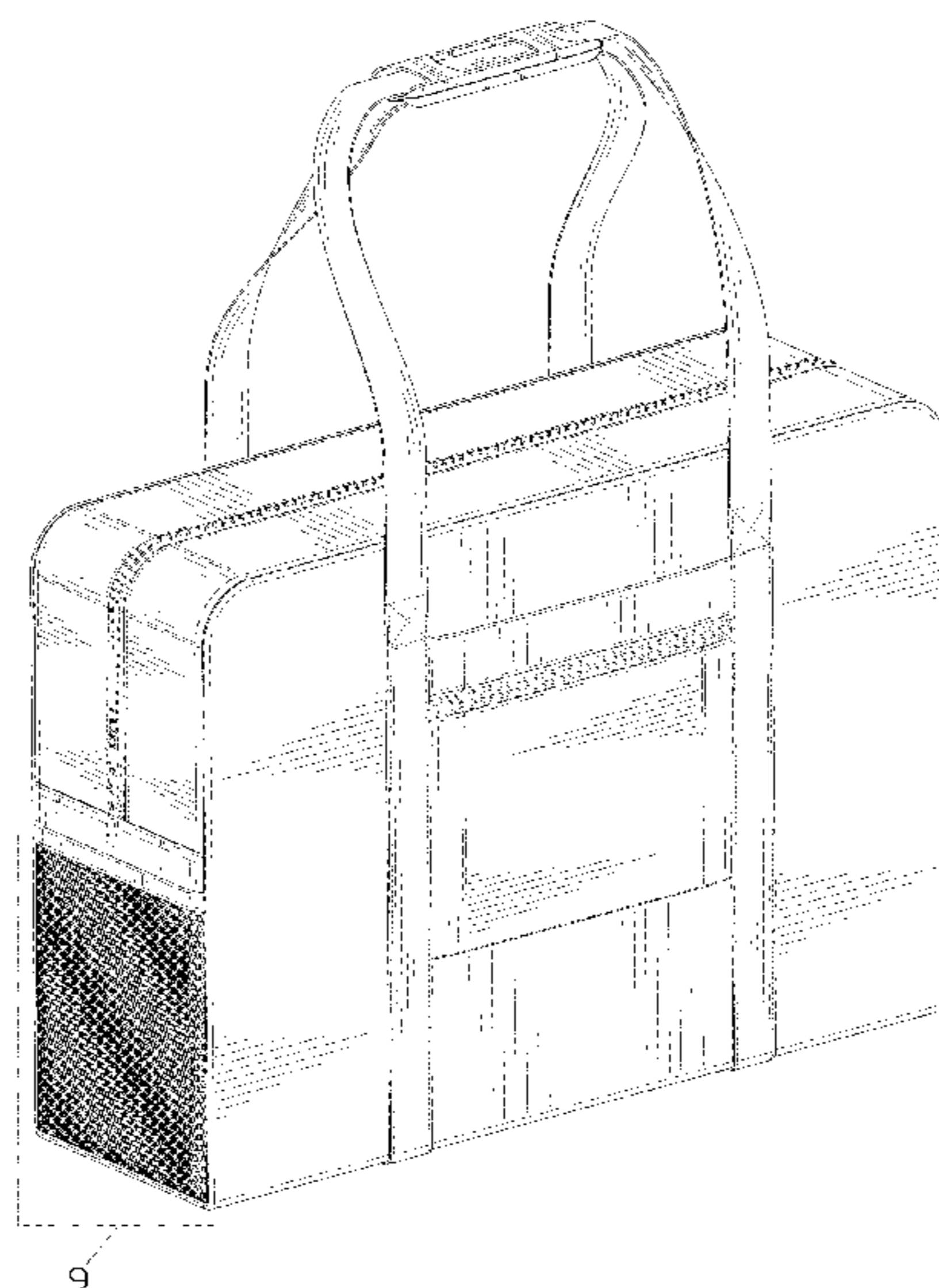

## (58) Field of Classification Search

USPC ... 190/903, 18 R, 124, 1, 125, 11, 122, 902, 190/39, 113, 100, 112, 126, 8, 2, 16, 901, 190/28, 121, 101, 106, 120, 900, 12 R, 190/37, 117, 26, 105, 13 R, 24, 116, 36, 190/123, 118, 17, 104, 21, 12 A, 30, 190/13 F, 9, 22, 40, 35; D9/432, 434, D9/418, 433, 703, 415, 423, 707, 643, D9/420, 430, 709, 721, 424, 431, 414, D9/705, 702, 425, 435, 706, 456, 704, D9/416, 428, 455, 443, 600, 422, 624, D9/529, 711, 629, 734, 756, 504, 708, D9/737, 658, 449, 421, 426, 575, 635, D9/447, 757, 503; 224/153, 404, 576, 224/627, 637, 645, 275, 413, 191, 539, 224/155, 652, 628, 653, 542, 543, 579, 224/328, 401, 259, 578, 581, 644, 274, 224/257, 930, 643, 321, 666, 633, 42.34, 224/572, 240, 326, 577, 610, 585, 600, 224/563, 282, 679, 250, 264, 430, 629, 224/657, 901.4, 583, 262, 311, 325, 224/42.32, 483, 222, 235, 309, 435, 557, 224/236, 269, 324, 427, 547, 580, 281, 224/417, 651, 553, 631, 431, 463, 908, 224/403, 674, 913, 575, 650, 156, 634, 224/920, 439, 524, 617, 448, 607, 613, 224/677, 901.8, 319, 584, 660, 681, 925, 224/42.13, 148.2, 245, 497, 635, 219, 224/42.36, 566, 642, 510, 329, 425, 527, 224/544, 614, 616, 241, 261, 424, 630, 224/682, 901.6, 926, 402, 526, 528, 558, 224/625, 675, 452, 641, 655, 919, 314, 224/315, 407, 42.39, 450, 604, 904, 922, 224/199, 518, 928, 438, 549, 664, 164, 224/420, 484, 487, 534, 582, 601, 917.5, 224/162, 197, 419, 422, 540, 647, 400, 224/418, 423, 489, 507, 554, 560, 907, 224/916, 929, 159, 331, 411, 567, 587, 224/654, 673, 680, 154, 316, 318, 605, 224/608, 638, 683, 148.7, 268, 42.33, 224/426, 498, 500, 513, 618, 640, 665, 224/917, 918, 160, 223, 258, 277, 429, 224/508, 541, 656, 901.2, 148.4, 148.5, 224/218, 312, 409, 42.11, 42.21, 486, 224/488, 514, 571, 915, 183, 242, 260, 224/310, 330, 406, 421, 445, 482, 495, 224/515, 519, 586, 609, 646, 516, 529, 224/622, 667, 158, 217, 267, 270, 433, 224/506, 509, 511, 538, 632, 636, 676, 224/148.3, 196, 221, 322, 327, 405, 224/42.24, 42.4, 437, 496, 499, 504, 512, 224/532, 564, 602, 612, 668, 237, 251, 224/278, 410, 42.12, 440, 449, 453, 505, 224/517, 521, 525, 545, 568, 934; 150/106, 117, 147, 112, 159, 113, 154, 150/123, 107, 110, 143, 132, 134, 138, 150/108, 105, 111, 118, 145, 131, 129, 150/149, 127, 126, 137, 139, 103, 102, 150/133, 136, 120, 104, 116, 115, 101, 150/125, 130, 900, 146, 119, 148, 114, 150/160, 142, 128, 140, 141, 100, 165; 223/107, 85, 84, 66

CPC ..... A45C 11/12; A45C 11/10; A45C 11/16; A45C 11/00; A45C 13/02; A45C 5/14; A45C 2011/002; A45C 2011/003; A45C

15/00; A45C 9/00; A45C 13/262; A45C 3/00; A45C 5/03; A45C 13/103; A45C 13/30; A45C 13/26; A45C 11/20; A45C 1/06; A45C 2013/026; A45C 3/001; A45C 2013/025; A45C 3/02; A45C 2200/15; A45C 5/02; A45C 13/36; A45C 2011/001; A45C 5/00; A45C 3/06; A45C 2013/267; A45C 7/0077; A45C 13/04; A45C 13/005; A45C 13/002; A45C 11/182; A45C 13/008; A45C 5/06; A45C 13/10; A45C 11/24; A45C 11/04; A45C 3/04; A45C 13/03; A45C 13/001; A45C 13/18; A45C 15/06; A45C 13/28; A45C 7/0045; A45C 11/38; A45C 7/0086; A45C 13/1069; A45C 2003/007; A45C 3/004; A45C 7/0036; A45C 2005/037; A45C 13/385; A45C 2013/306; A45C 11/005; A45C 13/00; A45C 7/0095; A45C 2200/10; A45C 2009/007; A45C 11/008; A45C 5/146; A45C 13/08; A45C 13/42; A45C 2011/007; A45C 13/06; A45C 7/0063; A45C 2013/1015; A45C 11/323; A45C 2001/065; A45C 13/1046; A45C 7/0022; A45C 11/34; A45C 13/1076; A45C 13/1084; A45C 3/10; A45C 11/18; A45C 5/143; A45C 2003/008; A45C 2005/148; A45C 13/20; A45C 5/005; A45C 3/12; A45C 11/22; A45C 2005/035; A45C 7/0054; A45C 1/04; A45C 2009/002; A45C 7/0031; A45C 2003/002; A45C 13/185; A45C 2007/0004; A45C 13/24; A45C 7/0068; A45C 11/02; A45C 13/34; A45C 2001/067; A45C 3/08; A45C 1/02; A45C 11/32; A45C 7/009; A45C 7/0059; A45C 2013/265; A45C 7/0027; A45C 11/321; A45C 11/324; A45C 2001/062; A45C 7/005; A45C 2011/186; A45C 11/26; A45C 1/12; A45C 2009/005; A45C 5/04; A45C 13/22; A45C 7/00; A45C 13/1092; A45C 1/08; A45C 5/08; A45C 13/004; A45C 2200/20; A45C 13/021; A45C 13/38; A45C 13/40; A45C 2011/188; A45C 15/04; A45C 13/1023; A45C 2003/005; A45C 5/145; A45C 2200/00; A45C 7/0081; A45C 11/36; A45C 2007/0013; A45C 13/023; A45C 2200/05; A45F 3/04; A45F 3/02; A45F 5/00; A45F 4/02; A45F 2003/003; A45F 3/047; A45F 2200/0516; A45F 5/021; A45F 3/14; A45F 3/08; A45F 2003/045; A45F 5/02; A45F 2005/008; A45F 2200/0525; A45F 2005/006; A45F 2003/001; A45F 3/12; A45F 3/005; A45F 2003/142; A45F 3/10; A45F 3/00; A45F 2004/026; A45F 4/12; A45F 4/06; A45F 5/1026; A45F 3/06; A45F 5/10; A45F 2200/0575; A45F 2003/146; A45F 3/042; A45F 2003/122; A45F 3/20; A45F 5/1046; A45F 2005/1073; A45F 2005/002; A45F 2200/0508; A45F 2200/0583; A45F 3/16; A45F 2004/023; A45F 2003/166; A45F 2200/0566; A45F 2003/144; A45F 2005/1033; A45F 2200/0541; A45F 2003/002; A45F 4/00; A45F 3/46; A45F

5/004; A45F 2003/127; A45F 2003/125;  
A45F 2200/05; A45F 2200/0591; A45F  
2200/0533; A45F 4/04

See application file for complete search history.

(56)

**References Cited**

U.S. PATENT DOCUMENTS

D768,378 S	*	10/2016	Schilp .....	D3/232
D878,750 S	*	3/2020	Dehmoubed .....	D3/246
D883,047 S	*	5/2020	Kou .....	D7/607
D907,922 S		1/2021	Dooling	
D915,070 S		4/2021	Wang	
D917,164 S	*	4/2021	Zhang .....	D3/245
D926,469 S	*	8/2021	Barlier .....	D3/246
D952,336 S	*	5/2022	Piccioli .....	D3/246
D953,024 S	*	5/2022	Dumas .....	D3/246
D956,419 S	*	7/2022	Barlier .....	D3/283
D957,813 S	*	7/2022	Chen .....	D3/276

\* cited by examiner

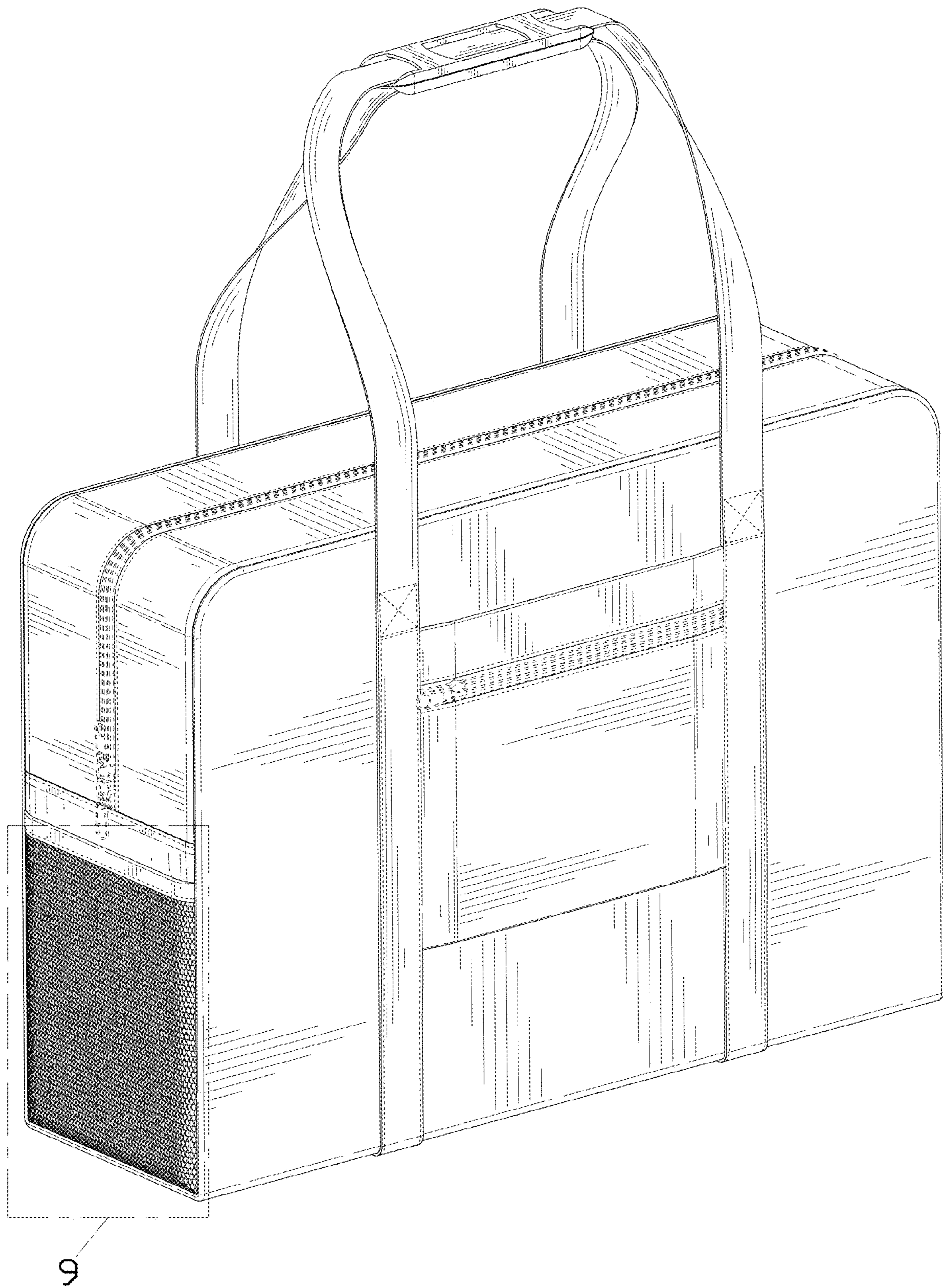

FIG. 1

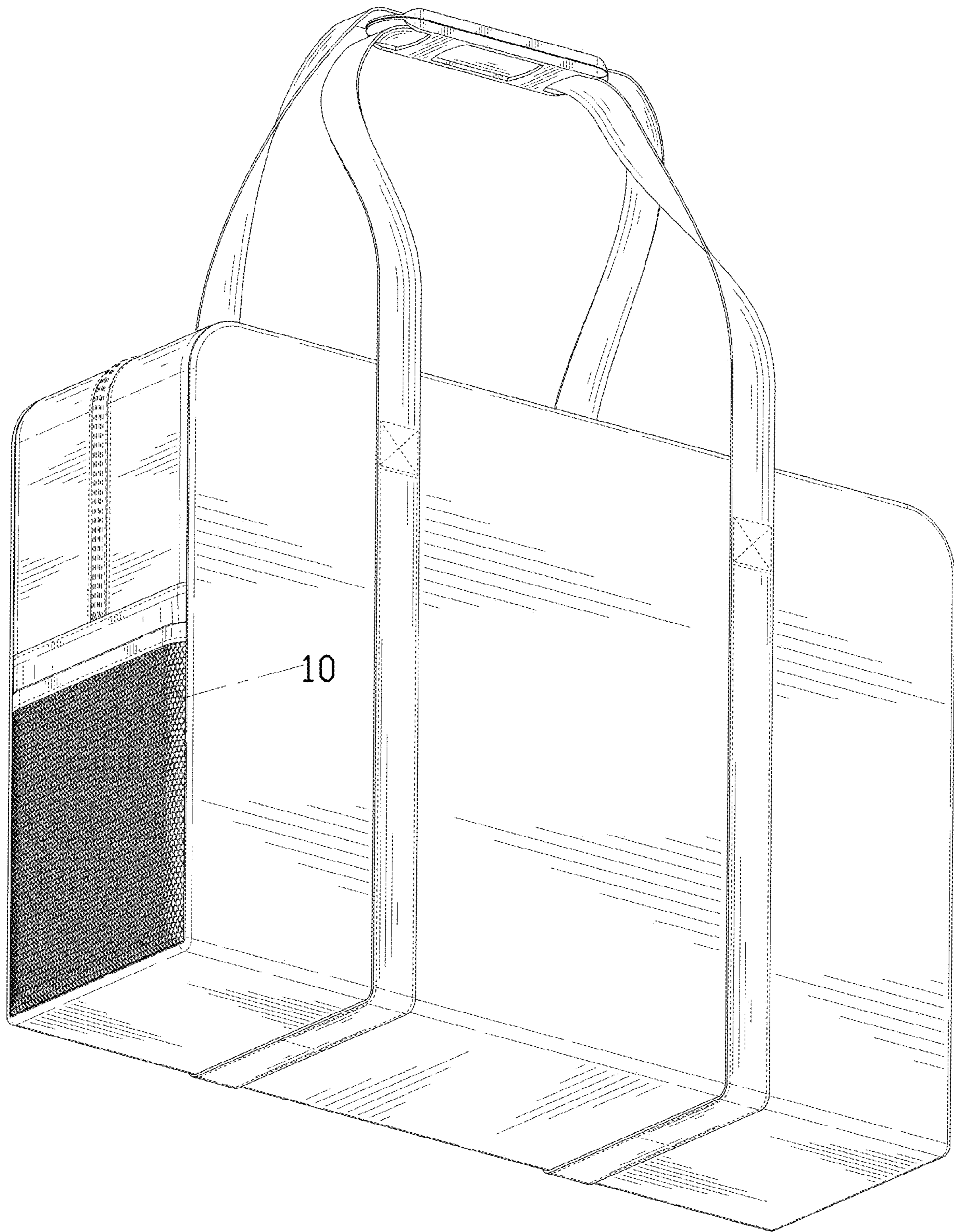

FIG. 2

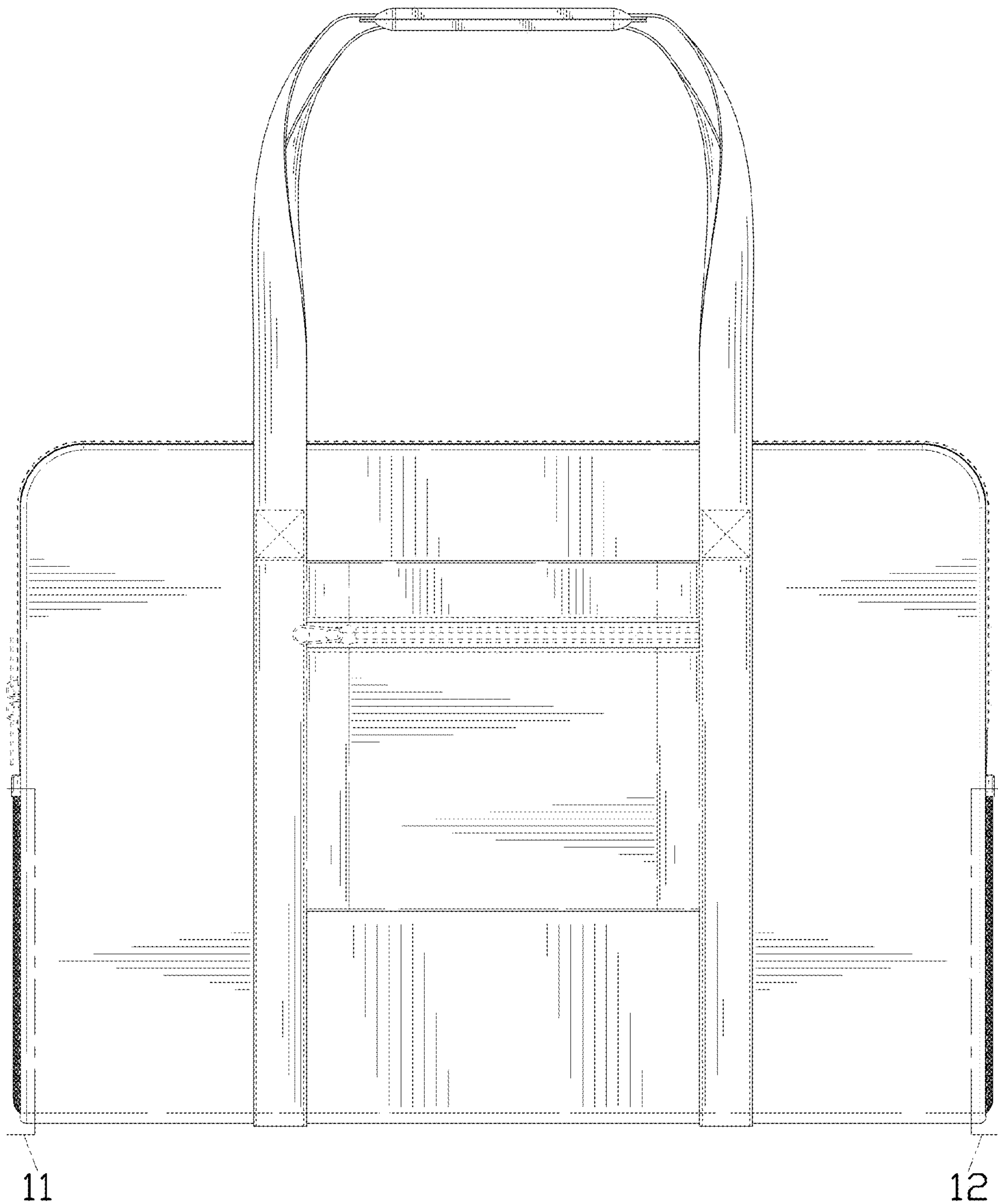

FIG. 3

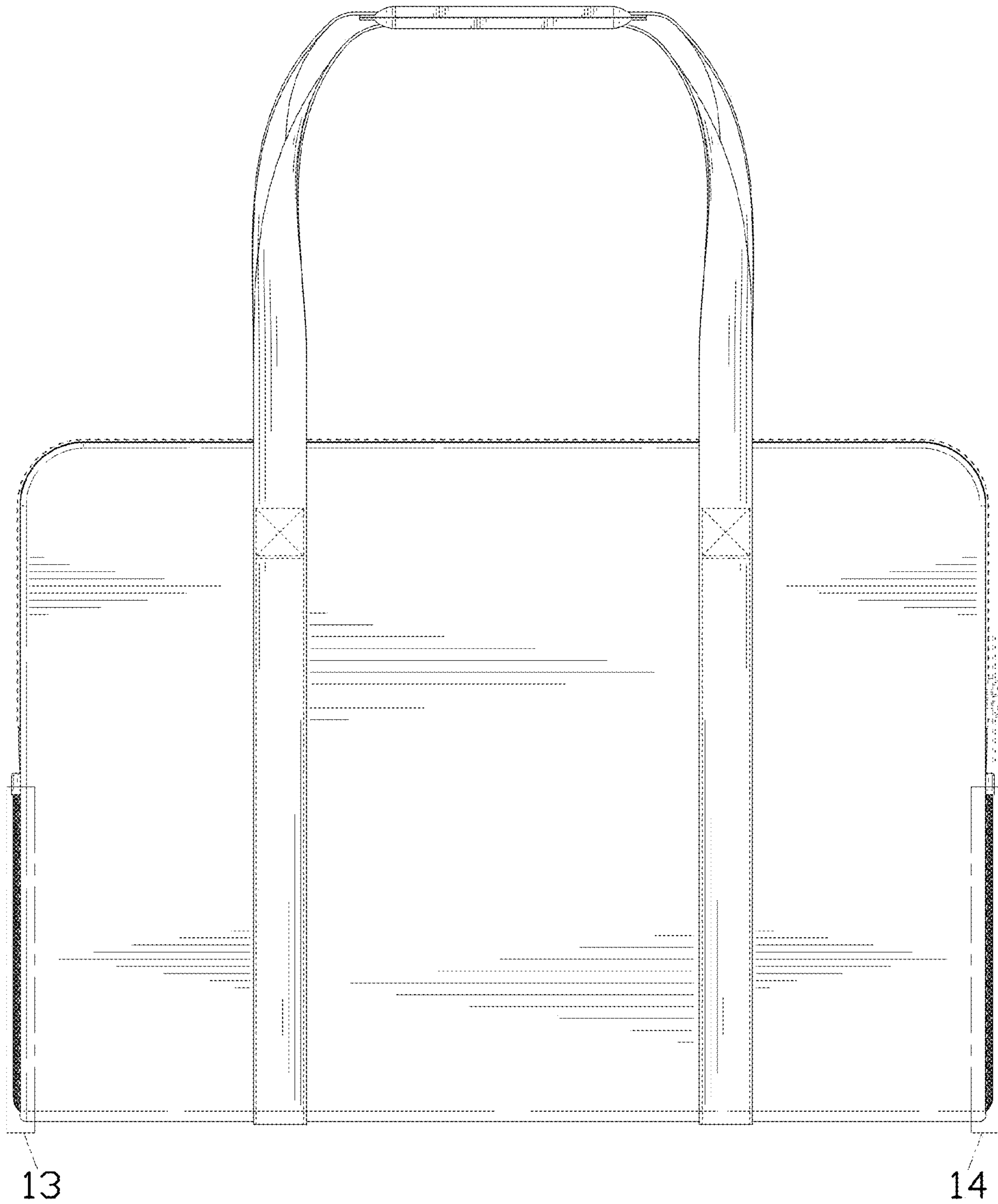

FIG. 4

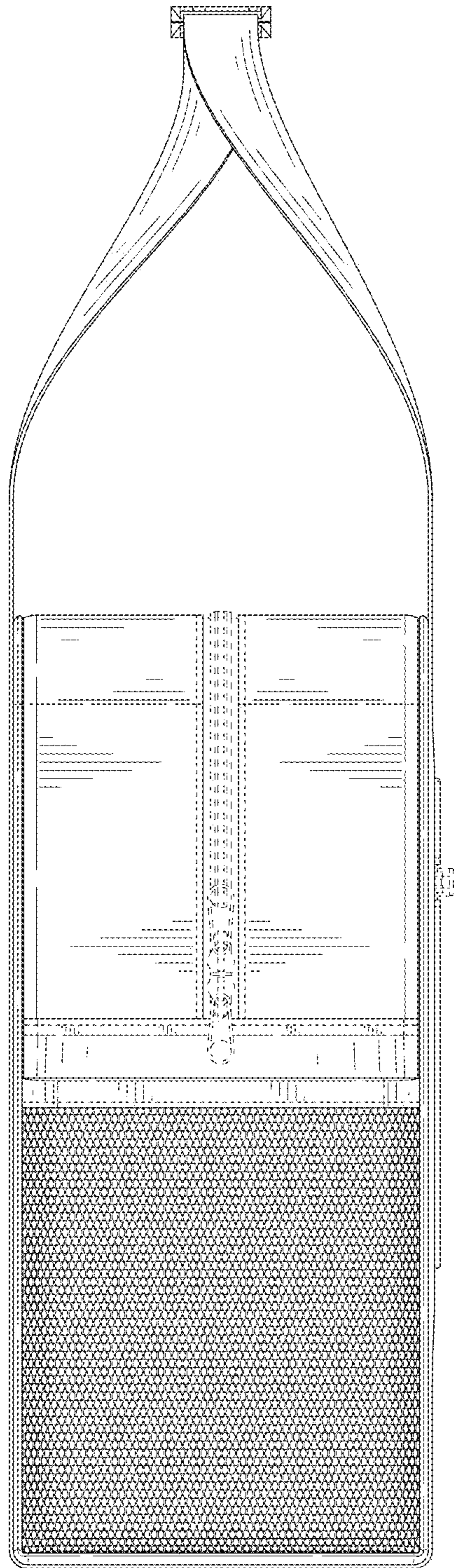

FIG. 5



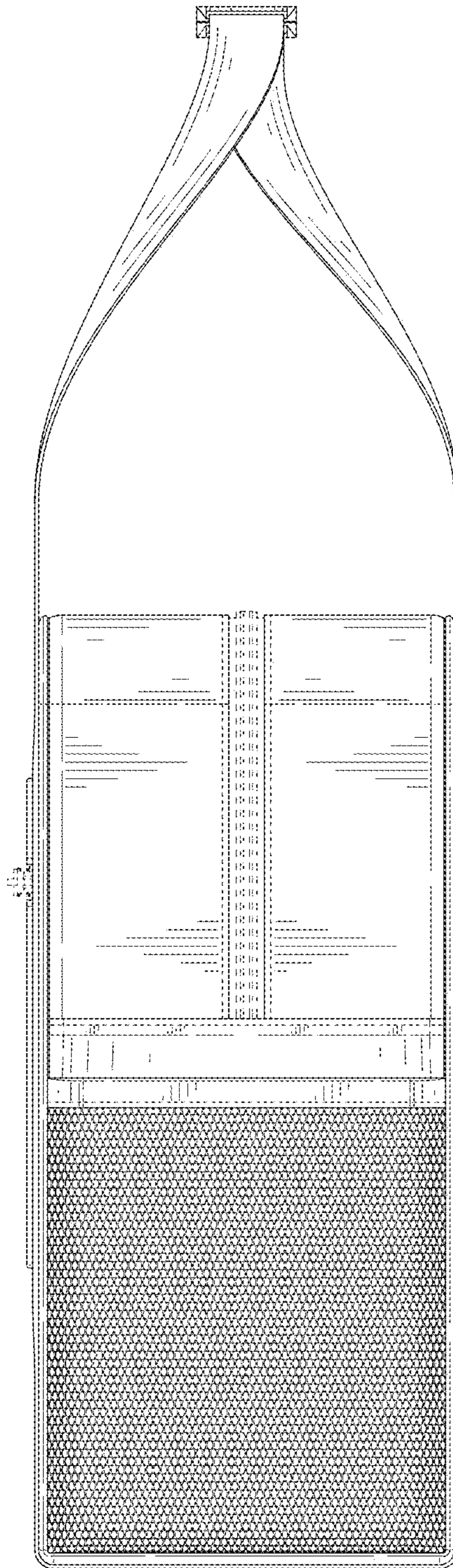

FIG. 6

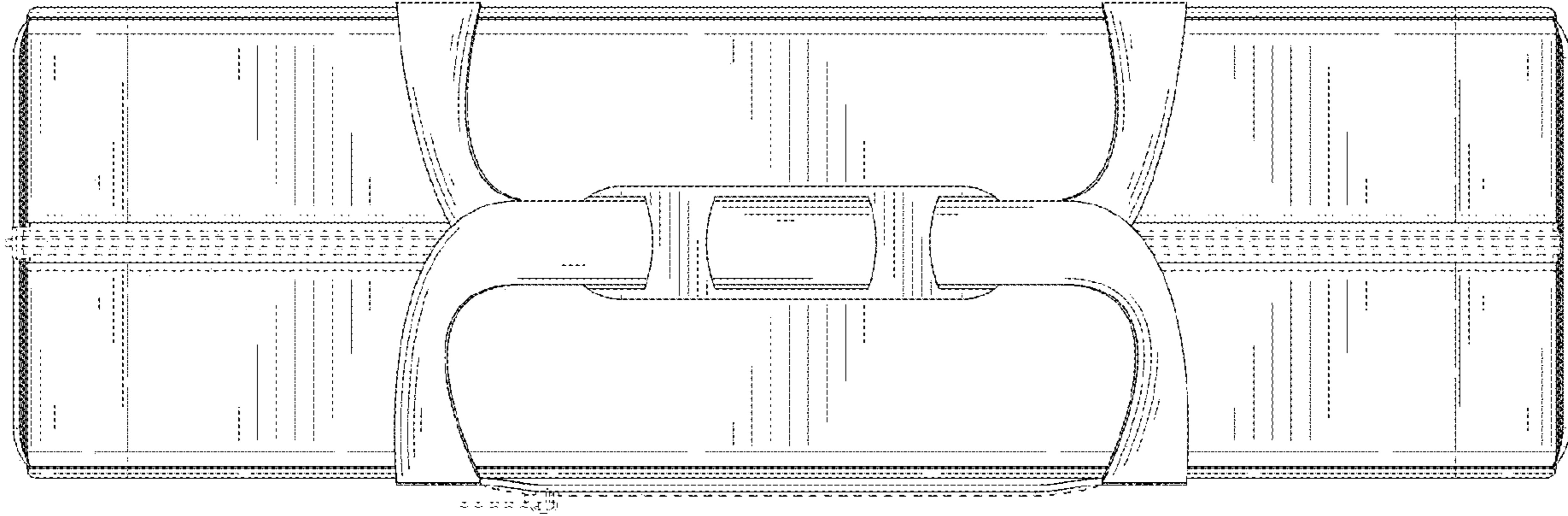

FIG. 7

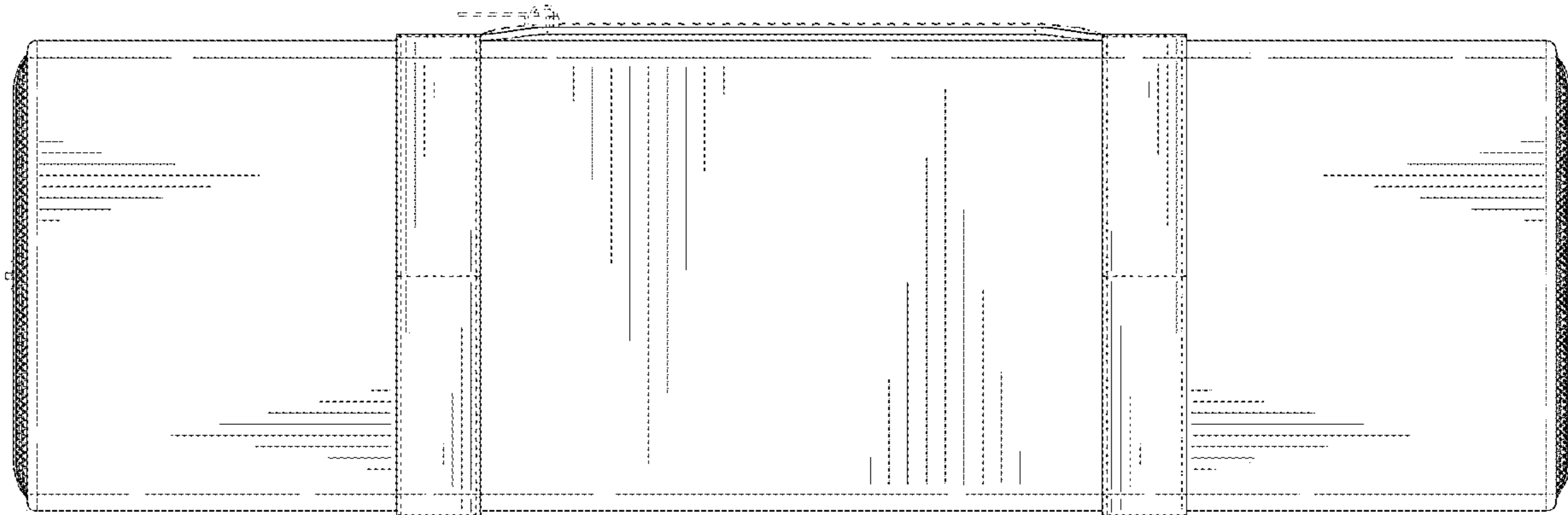

FIG. 8

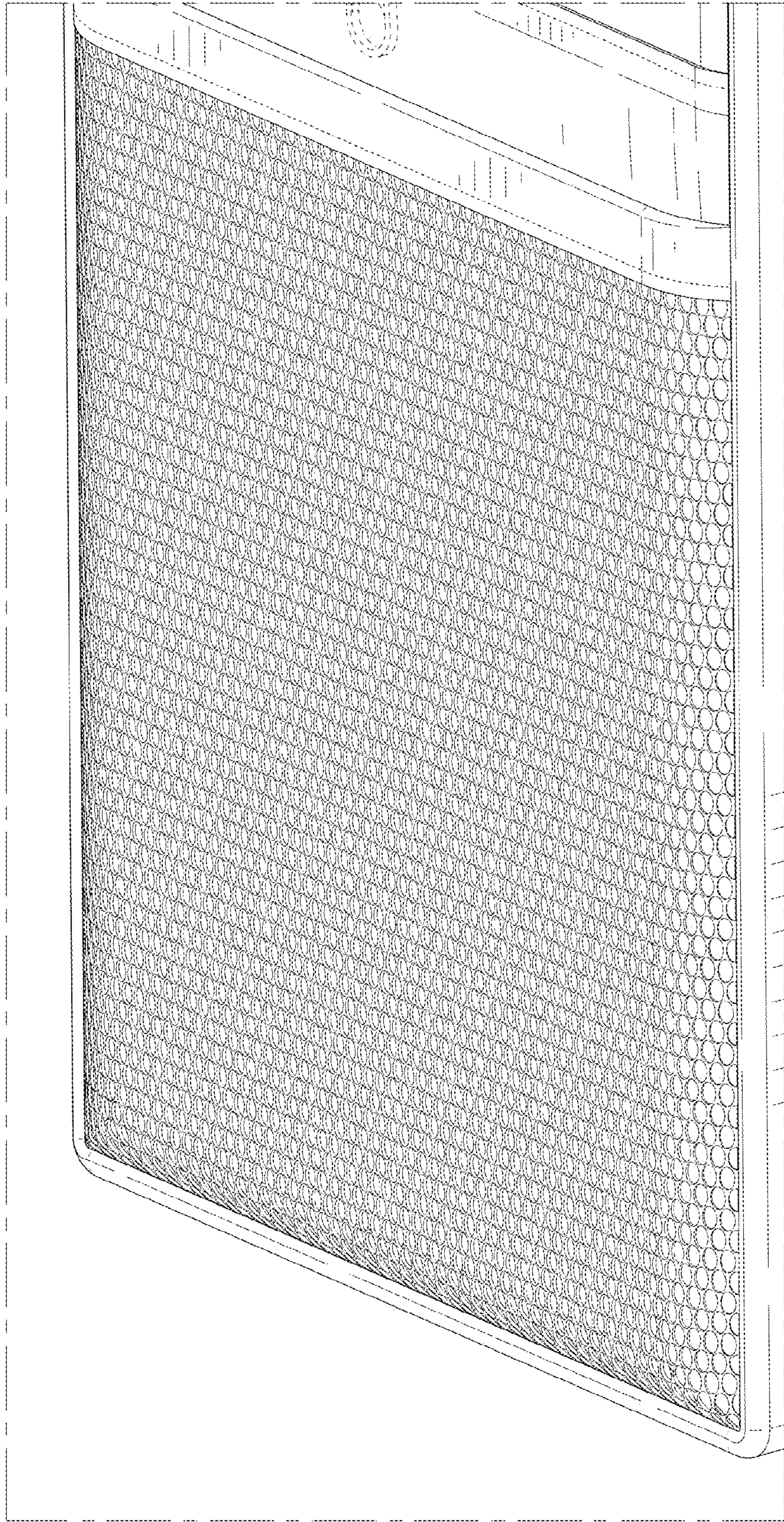

FIG. 9

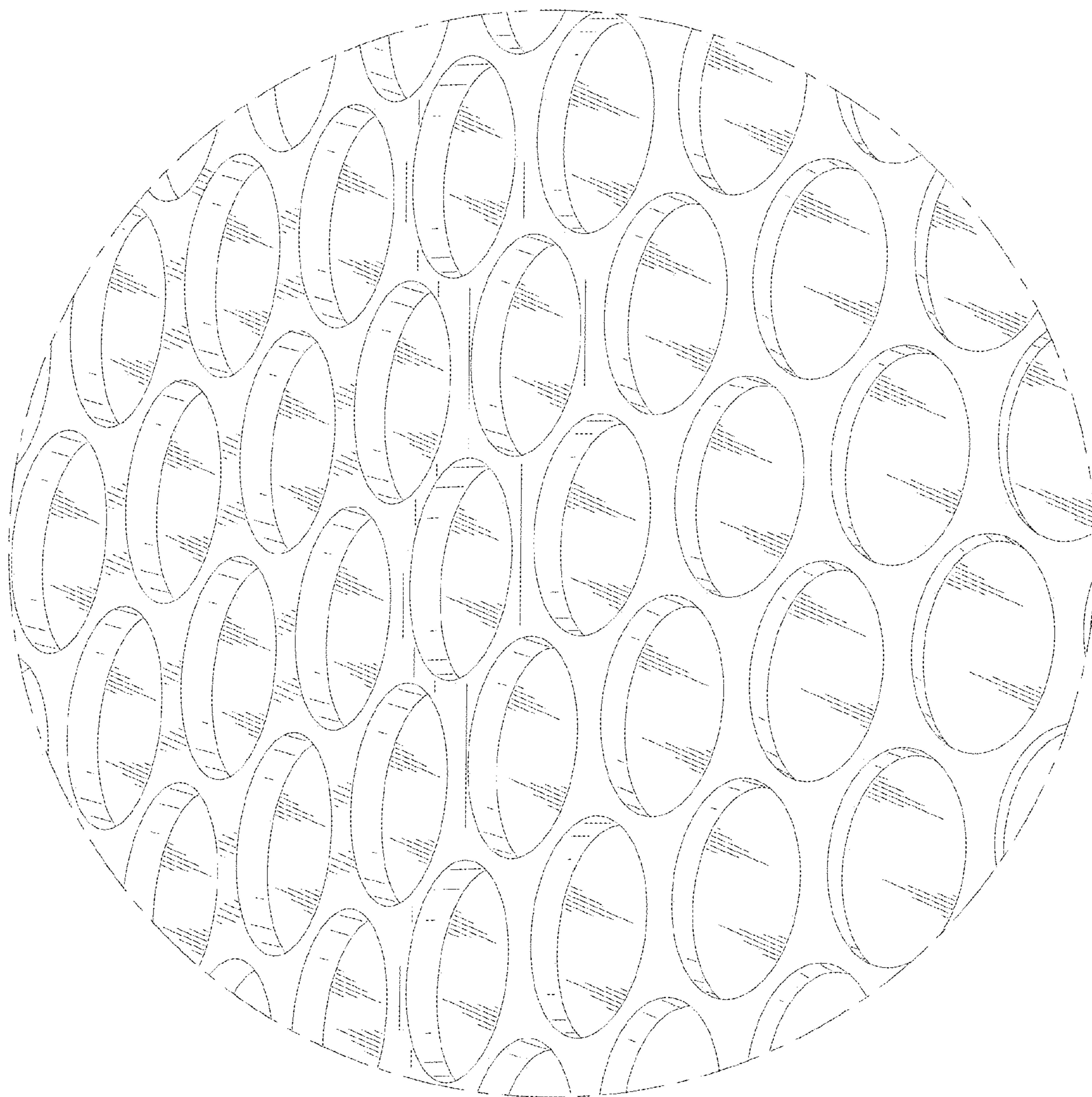

FIG. 10

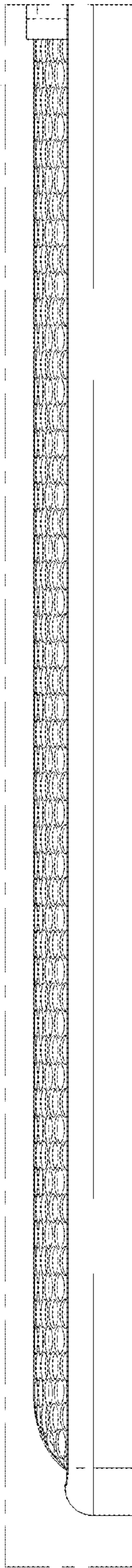

FIG. 11

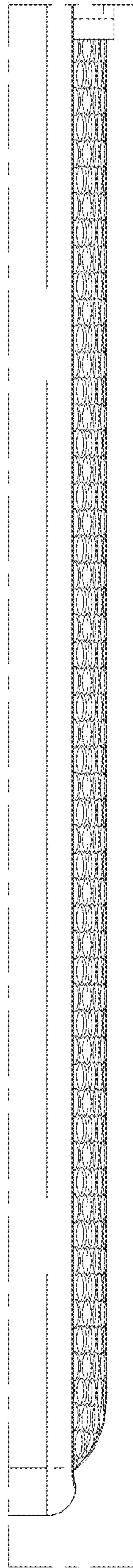

FIG. 12

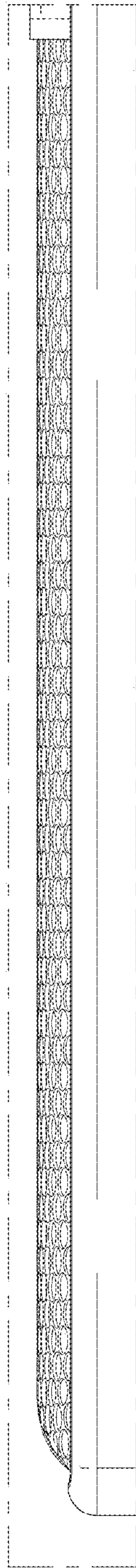

FIG. 13



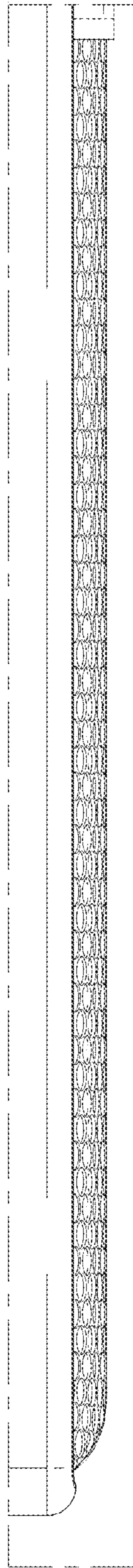

FIG. 14