



US00D987969S

(12) **United States Design Patent** (10) **Patent No.:** **US D987,969 S**
Esperse (45) **Date of Patent:** **** Jun. 6, 2023**

(54) **HEEL FOR FOOTWEAR**

(71) Applicant: **L'ATELIER DE CHAUSSURES, S.L.**,
Elda (ES)

(72) Inventor: **Valerie Esperse**, Elche (ES)

(**) Term: **15 Years**

(21) Appl. No.: **35/513,857**

(22) Filed: **Feb. 24, 2022**

(80) **Hague Agreement Data**

Int. Filing Date: **Feb. 24, 2022**

Int. Reg. No.: **DM/219346**

Int. Reg. Date: **Feb. 24, 2022**

Int. Reg. Pub. Date: **Mar. 18, 2022**

(51) **LOC (14) Cl.** **02-04**

(52) **U.S. Cl.**

USPC **D2/965**

(58) **Field of Classification Search**

USPC D2/897, 915, 918, 922, 925-942, 948,
D2/950, 964-968, 971, 972

CPC A43B 21/00; A43B 21/02; A43B 21/025;
A43B 21/03; A43B 21/04; A43B 21/06;
A43B 21/08; A43B 21/18; A43B 21/20;
A43B 21/24; A43B 1/10; A43B 1/14

See application file for complete search history.

(56) **References Cited**

U.S. PATENT DOCUMENTS

- D112,258 S * 11/1938 Levin 36/34 R
- D112,968 S * 1/1939 Squire D2/965
- D119,381 S * 3/1940 Calderazzo D2/950
- D127,514 S * 5/1941 Bergman D2/918
- D153,222 S * 3/1949 Huston D2/950
- D262,750 S * 1/1982 Melzi D2/918
- D675,417 S * 2/2013 Cheifetz D2/965
- D793,056 S * 8/2017 Venturi D2/965
- D820,574 S * 6/2018 Kirkwood D2/965
- D836,307 S * 12/2018 Larian D2/965
- D932,759 S * 10/2021 Roth D2/898

- D972,827 S * 12/2022 Neroni D2/965
- 2002/0133980 A1 * 9/2002 Pan A43B 21/24
36/100
- 2007/0062066 A1 * 3/2007 Cirolia A43B 21/025
36/34 R

FOREIGN PATENT DOCUMENTS

KR 3020180000339 * 3/2018

OTHER PUBLICATIONS

Give Some Much Needed Attention To Your Shoe Collection With Help From L'Atelier announced Jul. 27, 2022 [online], [site visited Oct. 28, 2022]. Available from internet, URL: <https://www.thecoolhour.com/2022/07/give-some-much-needed-attention-to-your-shoe-collection-with-help-from-latelier-de-charlotte/> (Year: 2022).
Fashion Mansion, ramon tenza flower heels, announced Feb. 19, 2020 [online], [site visited Jan. 3, 2023]. Available from internet, URL: <https://www.facebook.com/102525604438331/posts/ramon-tenza-flower-heels-are-the-new-stilettos/188517492505808/> (Year: 2020).*

* cited by examiner

Primary Examiner — Leanne Was-Englehart

Assistant Examiner — Yelizaveta Y Masalimova

(57) **CLAIM**

The ornamental design for a heel for footwear, as shown and described.

DESCRIPTION

- 1.1 is a top, front, right perspective view showing my new design;
- 1.2 is a right view thereof;
- 1.3 is a top view thereof;
- 1.4 is a front view thereof;
- 1.5 is a left view thereof;
- 1.6 is a bottom view thereof; and,
- 1.7 is a rear view thereof.

(Continued)

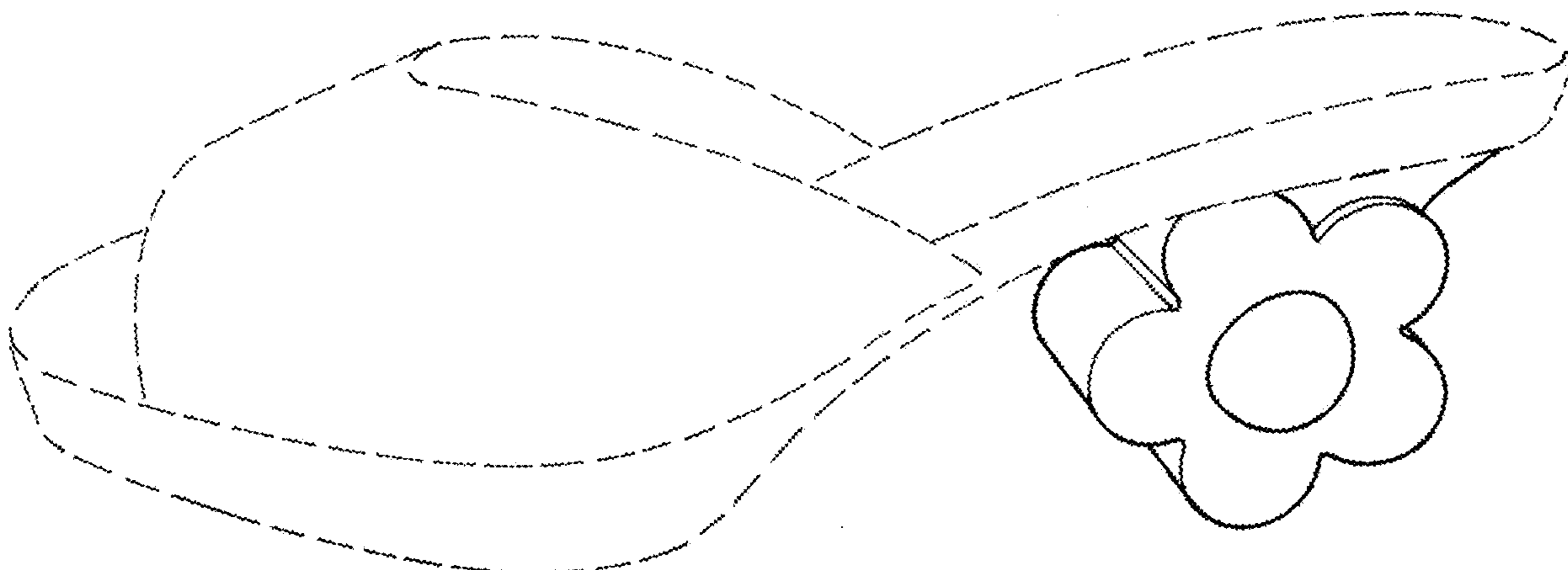

The broken lines shown are for the purpose of illustrating the environmental structure and forms no part of the claimed design.

1 Claim, 7 Drawing Sheets

1.1

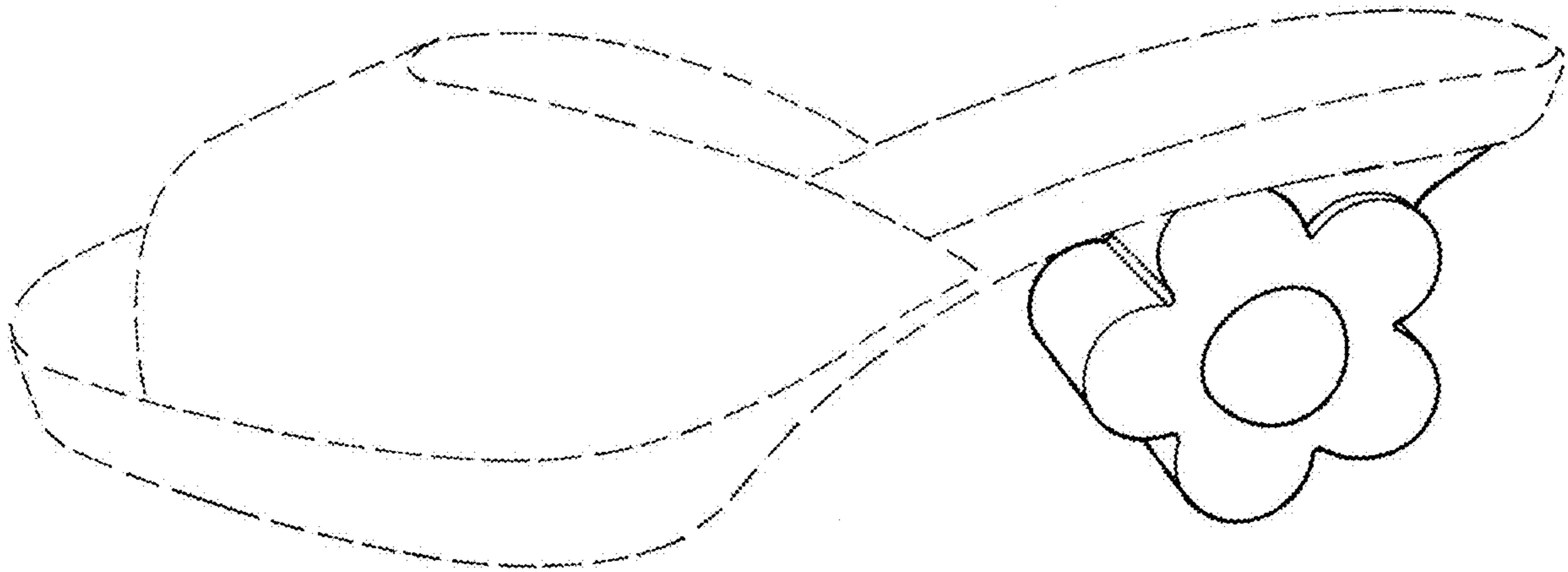

1.2

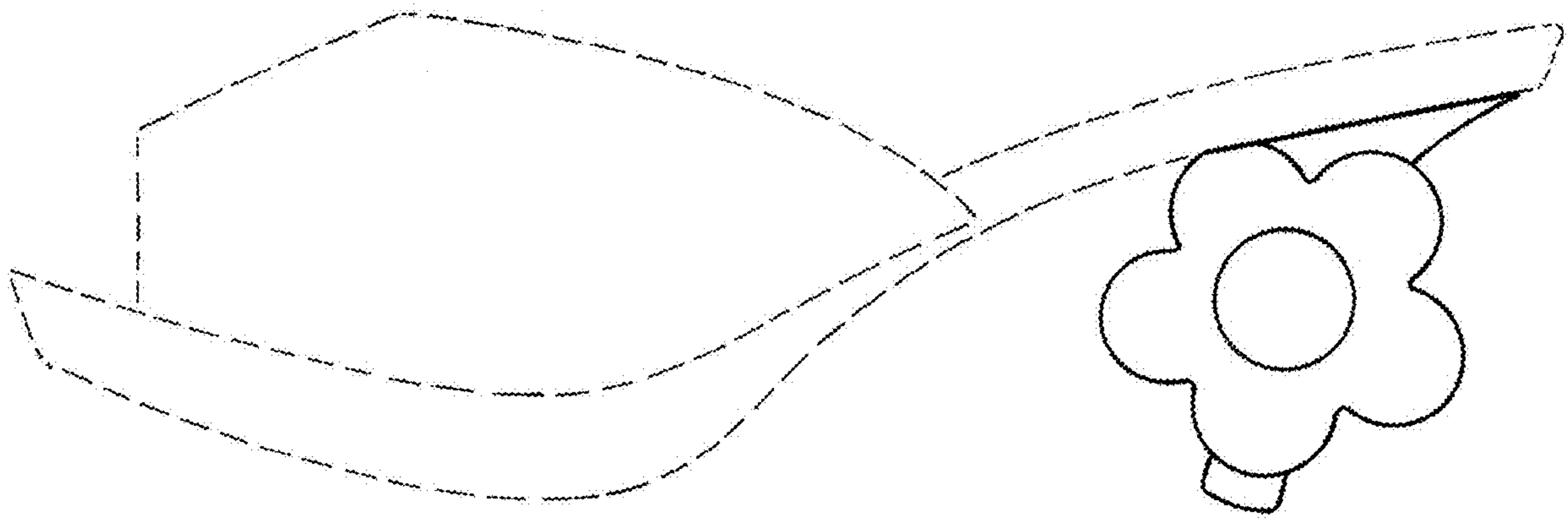

1.3

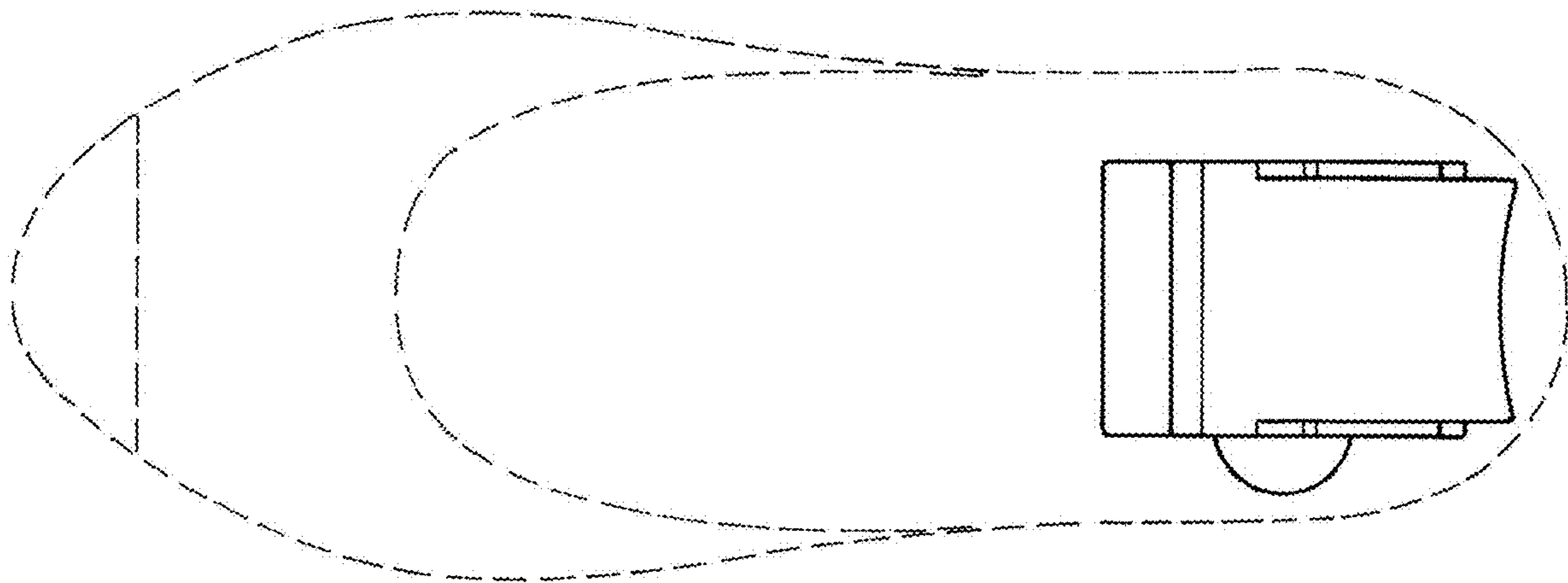

1.4

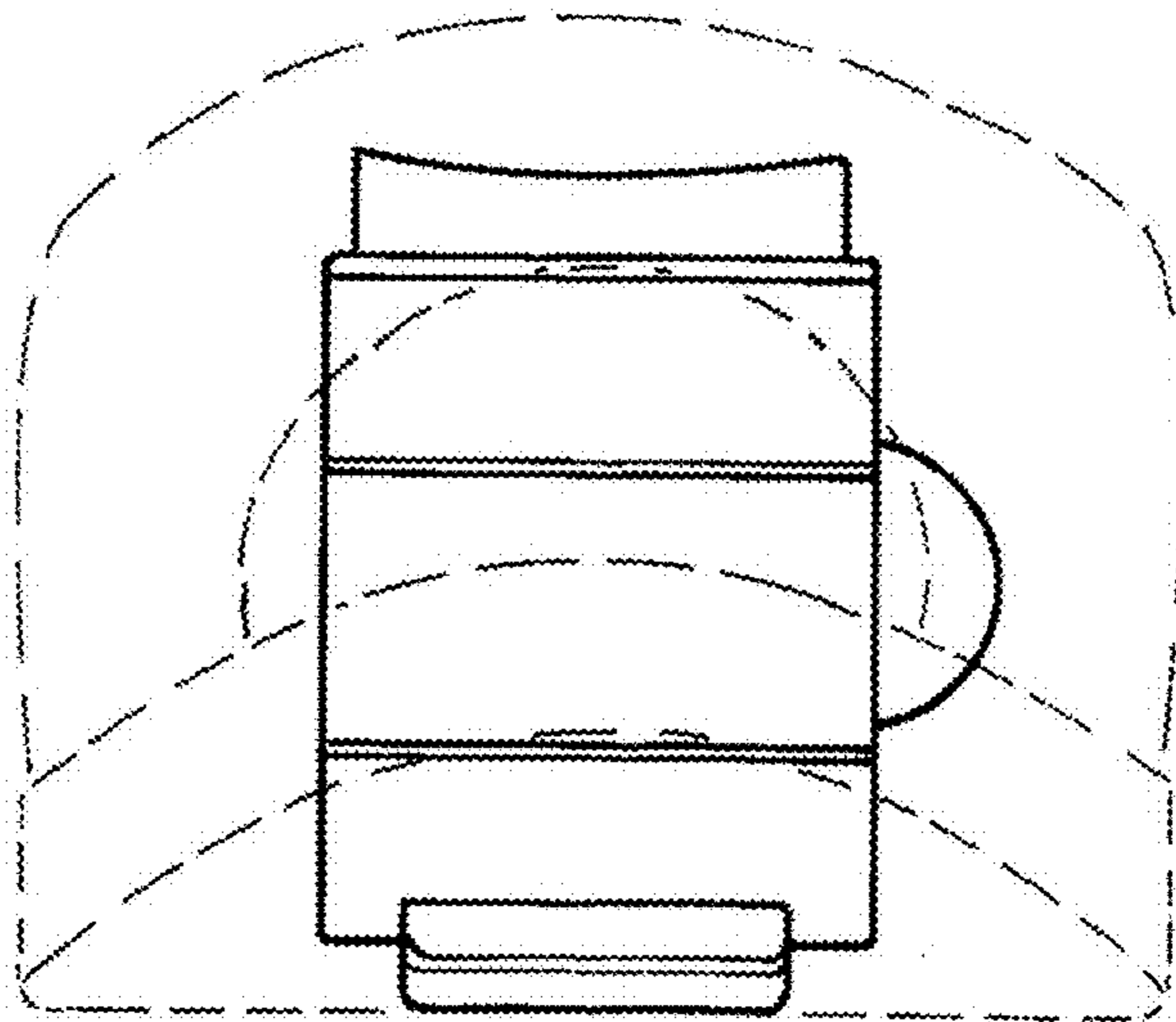

1.5

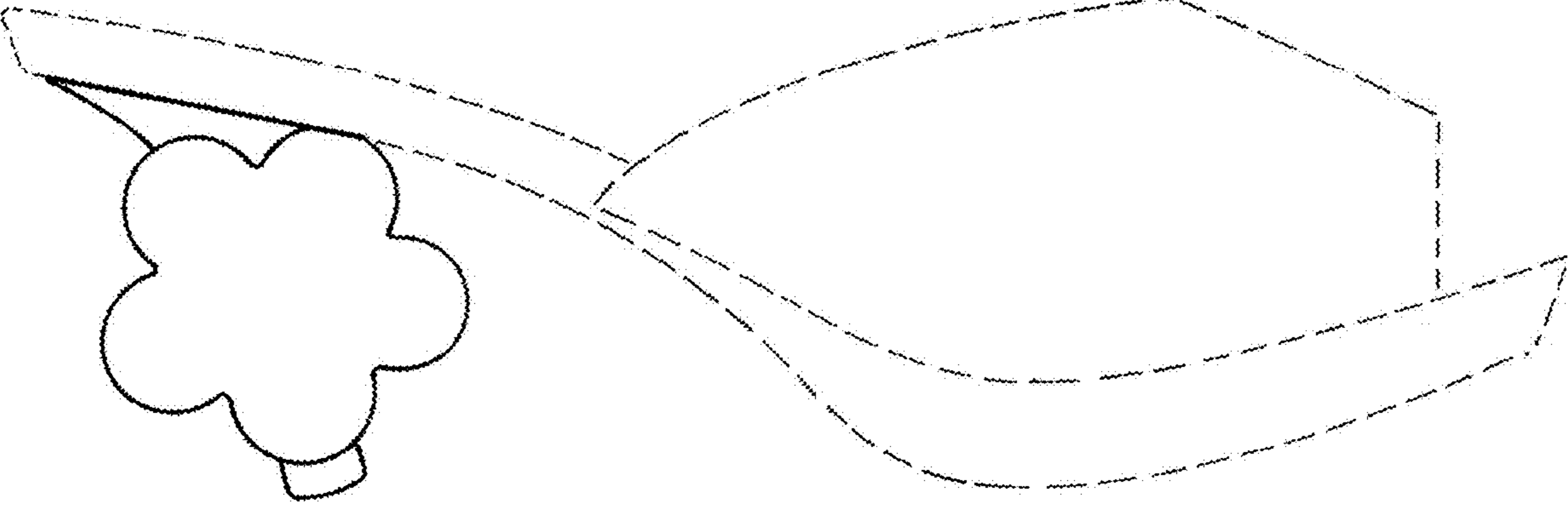

1.6

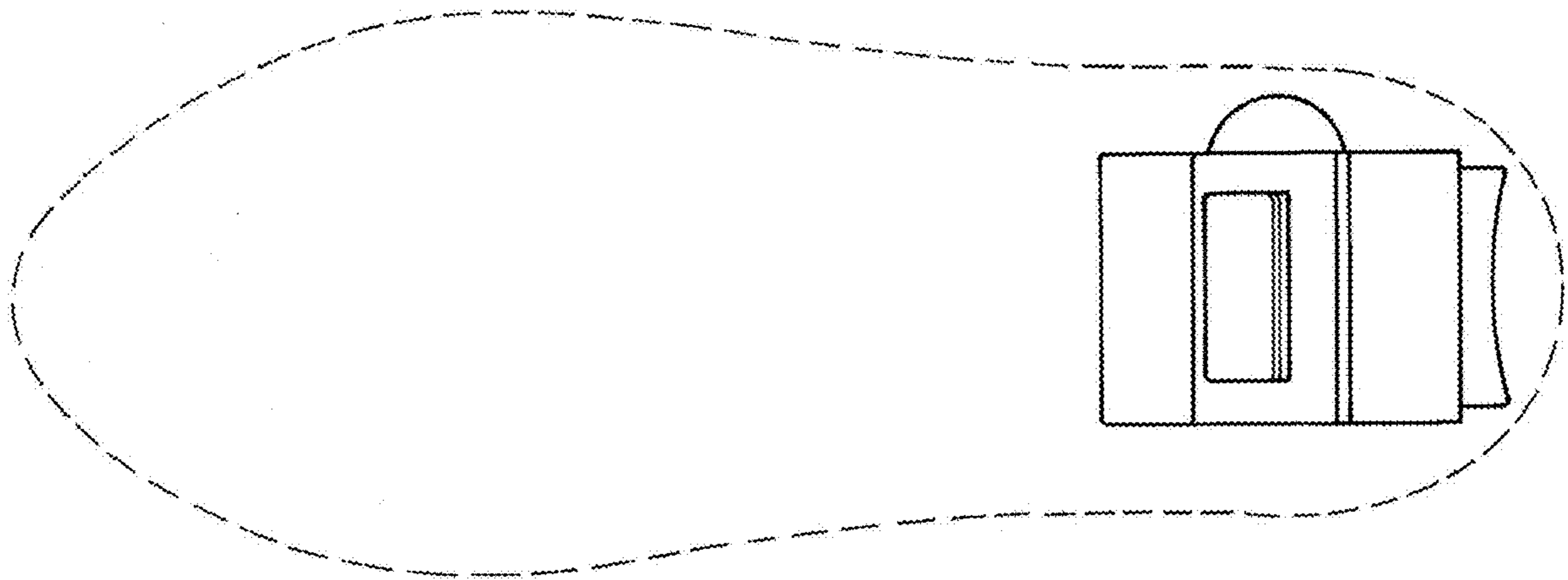

1.7

