



US00D987911S

(12) **United States Design Patent** (10) **Patent No.:** **US D987,911 S**  
**Pan** (45) **Date of Patent:** **\*\* May 30, 2023**

(54) **PET LIFE JACKET**

FOREIGN PATENT DOCUMENTS

(71) Applicant: **Min Pan**, Hangzhou (CN)

CA 108744 10/2004  
EM 002431189 3/2014

(72) Inventor: **Min Pan**, Hangzhou (CN)

(Continued)

(\*\*) Term: **15 Years**

OTHER PUBLICATIONS

(21) Appl. No.: **29/736,568**

“VivaGlory: Neoprene Life Vest”. Found online Sep. 1, 2022 at amazon.co.uk. Reference dated Aug. 29, 2019. Retrieved from <https://www.amazon.co.uk/VIVAGLORY-Sports-Style-Neoprene-Jacket/dp/B07X571MR3/>.\*

(22) Filed: **Jun. 1, 2020**

(Continued)

(51) **LOC (14) Cl.** ..... **30-01**

(52) **U.S. Cl.**

USPC ..... **D30/145**; D21/805

(58) **Field of Classification Search**

USPC ..... D30/144, 145, 151, 199; D21/801, 803, D21/804, 805; D2/828, 829, 830, 835, D2/838

CPC ..... A01K 13/006

See application file for complete search history.

*Primary Examiner* — Kendra Leslie Hamilton

(74) *Attorney, Agent, or Firm* — Fogarty LLP

(57)

**CLAIM**

The ornamental design for a pet life jacket, as shown and described.

(56)

**References Cited**

**DESCRIPTION**

U.S. PATENT DOCUMENTS

4,385,592 A	5/1983	Goldstein	
4,871,338 A	10/1989	Hoffman	
D313,676 S	1/1991	Indursky et al.	
5,193,486 A	3/1993	Kitchens	
D361,115 S *	8/1995	Lucius	D21/805
D363,572 S	10/1995	Obenchain	
D383,255 S	9/1997	Caditz	
D422,666 S	4/2000	Wagner	
D427,734 S	7/2000	Balzarini	
D429,390 S	8/2000	Grady et al.	
D429,391 S	8/2000	Grady et al.	
6,123,049 A	9/2000	Slater	
D443,910 S	6/2001	Wilbanks	
D459,842 S	7/2002	Kaplan	
6,447,353 B1	9/2002	Henry	
D480,843 S	10/2003	Sullivan	
D486,275 S	2/2004	Grubb	
D507,084 S	7/2005	Sabeh-Azar	
D510,160 S	9/2005	Rominger	

(Continued)

FIG. 1 is a top, front, left perspective view of a pet life jacket, showing my new design in a first configuration; FIG. 2 is a front elevation view thereof; FIG. 3 is a rear elevation view thereof; FIG. 4 is a right-side elevation view thereof; FIG. 5 is a left-side elevation view thereof; FIG. 6 is a top plan view thereof; FIG. 7 is a bottom plan view thereof; FIG. 8 is a top plan view thereof of the pet life jacket of FIG. 1, shown flat in a second configuration; and, FIG. 9 is a bottom plan view thereof.

The drawings are shaded to indicate contrasting surfaces. The broken lines showing of life jacket hardware (fasteners and clips) depict environmental subject matter only and forms no part of the claimed design. The broken lines showing on the life jacket depicts stitching and forms no part of the claimed design.

**1 Claim, 9 Drawing Sheets**

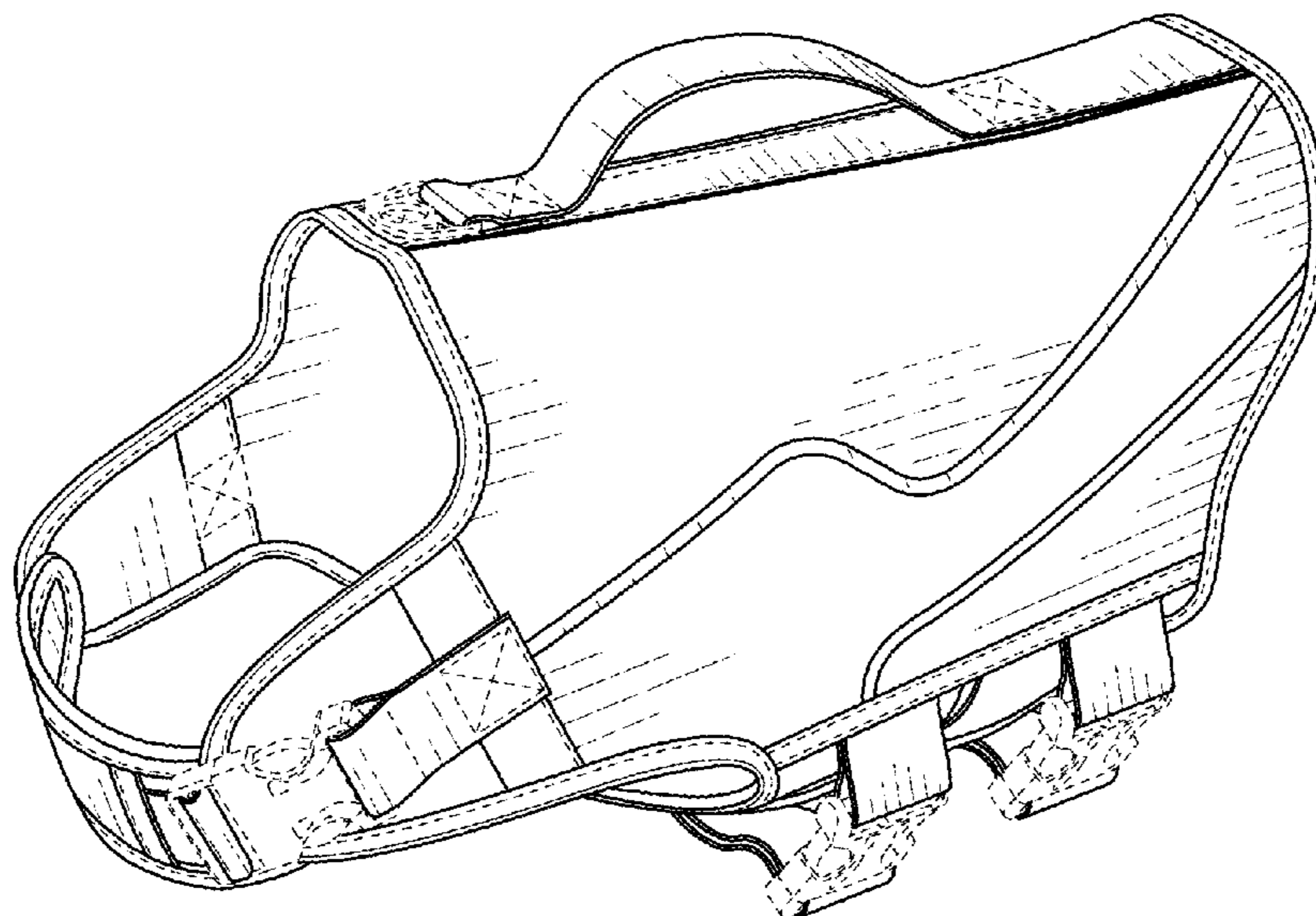

(56)

References Cited

U.S. PATENT DOCUMENTS

7,052,345	B1	5/2006	Rowan	
D526,452	S	8/2006	Crain	
D554,225	S *	10/2007	Peterson	D21/805
D585,606	S	1/2009	Kennedy	
7,559,817	B2	7/2009	Von Zell	
D633,257	S	2/2011	Trias	
D653,409	S	1/2012	Elliott	
D656,681	S *	3/2012	Reisler	D29/101.4
D728,051	S *	4/2015	Rhind	D21/805
D736,482	S	8/2015	Lapresca	
D776,287	S *	1/2017	Leonard	D29/101.1
D814,717	S	4/2018	Puljujarvi et al.	
D828,964	S	9/2018	Pan	
D861,999	S *	10/2019	Yun	D30/145
D885,689	S *	5/2020	Xu	D30/152
D896,449	S *	9/2020	Dang	D30/152
D931,553	S *	9/2021	Yu	D30/152
D948,809	S *	4/2022	Pan	D30/145
2007/0272170	A1	11/2007	Milson	
2008/0223310	A1	9/2008	Remick et al.	
2010/0199927	A1	8/2010	Cigard et al.	
2010/0240272	A1 *	9/2010	Cosson	A01K 13/006 441/106
2012/0024239	A1	2/2012	Forbes	
2013/0025542	A1 *	1/2013	Gutierrez	A01K 13/006 119/600
2014/0041599	A1	2/2014	Sebo	
2014/0045395	A1	2/2014	Cannici	
2014/0069351	A1	3/2014	Stratton et al.	
2016/0015003	A1	1/2016	Watson et al.	
2017/0099807	A1 *	4/2017	Northrop	A01K 13/006

FOREIGN PATENT DOCUMENTS

JP	2008178332	1/2007
KR	20140001217	8/2015
WO	D084238	8/2014

OTHER PUBLICATIONS

“Guardian Gear: Aquatic Dog Preserver”. Found online Jul. 13, 2017 at amazon.com. Reference dated Feb. 3, 2007. Retrieved from <https://www.amazon.com/Guardian-Gear-Aquatic-Preserver-Orange/dp/B000N6J7DW/>. \*

“Julius-K9: Multifunctional Swim Vest”. Found online Feb. 4, 2020 at amazon.co.uk. Reference dated Sep. 1, 2014. Retrieved from <https://www.amazon.co.uk/Julius-K9-16SWM-IDC-M-Multifunctional-Vest-Medium/dp/B00E3X0K00/>. \*

“Thinkpet: Life Jacket”. Found online Sep. 1, 2022 at amazon.co.uk. Reference dated Jul. 19, 2018. Retrieved from <https://www.amazon.co.uk/ThinkPet-Reflective-Lifesaver-Floating-Adjustable/dp/B07FMR7MVH/>. \*

Juliette Morgan, “Dog Life Jacket”, Mar. 4, 2011, 2 pages.

Zstar-China Ltd, “Dog Life Jacket Pet Life Vest Outward Hound Saver Dog Swimming Preserver Safety clothing swimwear swimsuit”, downloaded Jul. 22, 2016, 11 pages.

Outward Hound, “Outward Hound Dog Lifejacket”, Feb. 22, 2014, 1 page, available at <http://www.petsmart.com/supplies-training/life-jackets-swimsuits/outwar> . . . .

Earth Doggy, “Dog Flotation Jacket”, Nov. 16, 2010, 2 pages.

Cross Peak Products, “Doggles Dog Life Jacket with Attachable Head Support for Swimming” downloaded Oct. 14, 2016, 7 pages, available at <http://www.crosspeakproducts.com/collections/dog-life-jackets/products/life-jacket-with-attachable-head-support>.

Aliexpress, “Dog Life Jacket Pet Life Vest Outward Hound Saver Dog Swimming Preserver Safety clothing swimwear swimsuit”, downloaded Oct. 14, 2016, 3 pages, available at [http://www.aliexpress.com/store/product/Dog-Life-Jacket-Pet-Life-Vest-Outward-Hound-Saver-Dog-Swimming-Preserver-Safety-clothing-swimwear/106599\\_32362508238.html](http://www.aliexpress.com/store/product/Dog-Life-Jacket-Pet-Life-Vest-Outward-Hound-Saver-Dog-Swimming-Preserver-Safety-clothing-swimwear/106599_32362508238.html).

Cross Peak Products, “Guardian Gear Deluxe Dog Life Jacket with Pillow Head Support”, downloaded Oct. 14, 2016, 7 pages, available at <http://www.crosspeakproducts.com/collections/dog-life-jackets/products/deluxe-dog-life-jacket-with-head-support>.

Henry and Clemmies, “Large Green Life Jacket”, downloaded Oct. 14, 2016, 2 pages, available at <http://www.petgiftsonline.com/Large-Green-Henry-and-Clemmie-s-Dog-Life-Jacket-p/lj-hc-green-1.htm>.

Kong, “AquaFloat Dog Flotation Vest, Pink, Small”, downloaded Oct. 14, 2016, 4 pages, available at [https://www.chewy.com/...&utm\\_content=KONG&utm\\_term=&gclid=CjwKEAjwhILABRDwo8mlqt6ug38SJACNSq\\_ktrNsowaV2EKKL9BVE8wUWFCEQtU62kSP1oFn698RUxoCGx\\_w\\_wcB&gclsrc=aw.ds](https://www.chewy.com/...&utm_content=KONG&utm_term=&gclid=CjwKEAjwhILABRDwo8mlqt6ug38SJACNSq_ktrNsowaV2EKKL9BVE8wUWFCEQtU62kSP1oFn698RUxoCGx_w_wcB&gclsrc=aw.ds).

Kong, “AquaPro Dog Flotation Vest, Green”, downloaded Oct. 14, 2016, 4 pages, available at [https://www.chewy.com/...utm\\_content=KONG&utm\\_term=&gclid=CjwKEAjwhILABRDwo8mlqt6ug38SJACNSq\\_kLqY4\\_-XYyp06NYcV4MohDPOZ7tiAFY3Bo\\_SUxmA-mRoC2nHw\\_wcB&gclsrc=aw.ds](https://www.chewy.com/...utm_content=KONG&utm_term=&gclid=CjwKEAjwhILABRDwo8mlqt6ug38SJACNSq_kLqY4_-XYyp06NYcV4MohDPOZ7tiAFY3Bo_SUxmA-mRoC2nHw_wcB&gclsrc=aw.ds).

Liopard, “Dog Life Jacket”, downloaded Oct. 14, 2016, 2 pages, available at [http://elegant-pet.com/goods-87-Dog-Life-Jacket-%E7%8B%97%E6%95%91%E7%94% . . . .](http://elegant-pet.com/goods-87-Dog-Life-Jacket-%E7%8B%97%E6%95%91%E7%94%...)

Outward Hound, “Lifejacket for Dogs, Orange Fish” downloaded Oct. 14, 2016, 4 pages, available at [https://www.chewy.com/...tent=Outward%20Hound&utm\\_term=&gclid=CjwKEAjwhILABRDwo8mlqt6ug38SJACNSq\\_kFiYoID\\_rWrx3g98hyaPjx4BL3qXjELdLqkPz-m9E3xoCMDHw\\_wcB&gclsrc=aw.ds](https://www.chewy.com/...tent=Outward%20Hound&utm_term=&gclid=CjwKEAjwhILABRDwo8mlqt6ug38SJACNSq_kFiYoID_rWrx3g98hyaPjx4BL3qXjELdLqkPz-m9E3xoCMDHw_wcB&gclsrc=aw.ds).

Outward Hound, “PupSaver Ripstop Dog Life Jacket” downloaded Oct. 14, 2016, 5 pages, available at [https://www.chewy.com/...tent=Outward%20Hound&utm\\_term=&gclid=CjwKEAjwhILABRDwo8mlqt6ug38SJACNSq\\_kVpwNoEoPcWOLwMrOzuMR96K8215ylJ8XA1wtll1aTxoCwFzw\\_wcB&gclsrc=aw](https://www.chewy.com/...tent=Outward%20Hound&utm_term=&gclid=CjwKEAjwhILABRDwo8mlqt6ug38SJACNSq_kVpwNoEoPcWOLwMrOzuMR96K8215ylJ8XA1wtll1aTxoCwFzw_wcB&gclsrc=aw).

Ruffwear, “K-9 Float Coat™”, downloaded Oct. 14, 2016, 4 pages, available at [http://www.cabelas.com/...993&rid=208gclid=CjwKEAjwhILABRDwo8mlqt6ug38SJACNSq\\_kqlaT01ikMVB87qYhsMXntk3jRfBraqrRE6xfSiaQBoCe63w\\_wcB&gclsrc=aw.ds](http://www.cabelas.com/...993&rid=208gclid=CjwKEAjwhILABRDwo8mlqt6ug38SJACNSq_kqlaT01ikMVB87qYhsMXntk3jRfBraqrRE6xfSiaQBoCe63w_wcB&gclsrc=aw.ds).

“Vivaglory Dog Life Jackets with Extra Padding for Dogs”. Found online Jul. 13, 2017 at amazon.com. Page dated Feb. 26, 2016. Retrieved from [https://www.amazon.com/Nivaglory-Jackets-Extra-Padding-X-Large/dp/B01ABQ318K/ref=cm\\_cr\\_arp\\_d\\_product\\_top?ie=UTF8](https://www.amazon.com/Nivaglory-Jackets-Extra-Padding-X-Large/dp/B01ABQ318K/ref=cm_cr_arp_d_product_top?ie=UTF8).

“Dog Life Vests: Our Top 5 Picks”. Found online Jul. 13, 2017 at k9ofmine.com. Page dated May 26, 2015. Retrieved from <https://www.k9ofmine.com/best-dog-life-vests/>.

“PetCee Dog Life Jacket Quick Release Easy-Fit”. Found online Jul. 13, 2017 at amazon.com. Page dated Jul. 24, 2015. Retrieved from [https://www.amazon.com/Jacket-Adjustable-Jackets-Dogs-PetCee/dp/B00YG73HV2/ref=cm\\_cr\\_arp\\_d\\_product\\_top?ie=UTF8](https://www.amazon.com/Jacket-Adjustable-Jackets-Dogs-PetCee/dp/B00YG73HV2/ref=cm_cr_arp_d_product_top?ie=UTF8).

“Hurtta Collection, Life Jacket for Dogs”. Found online Aug. 24, 2017 at amazon.com. Page dated Jun. 5, 2013. Retrieved from [https://www.amazon.com/Hurtta-Collection-20-40-Pound-17-20-Inch-21-28-Inch/dp/B004UQNX9K/ref=cm\\_cr\\_arp\\_d\\_product\\_top?ie=UTF8](https://www.amazon.com/Hurtta-Collection-20-40-Pound-17-20-Inch-21-28-Inch/dp/B004UQNX9K/ref=cm_cr_arp_d_product_top?ie=UTF8).

“Vivaglory Dog Life Jacket” Found online Jul. 18, 2018 at amazon.com. Retrieved from [https://www.amazon.com/Vivaglory-Neoprene-Skin-friendly-Reflective-Adjustable/dp/B076J3KQLG/ref=sr\\_1\\_1\\_sspa?ie=UTF8&qid=1531948851&sr=8-1-spons&keywords=vivaglory+dog+life+jacket&psc=1](https://www.amazon.com/Vivaglory-Neoprene-Skin-friendly-Reflective-Adjustable/dp/B076J3KQLG/ref=sr_1_1_sspa?ie=UTF8&qid=1531948851&sr=8-1-spons&keywords=vivaglory+dog+life+jacket&psc=1).

“Outward Hound Dawson Dog Life Jacket” Found online Jul. 18, 2018 at amazon.com. Retrieved from [https://www.amazon.com/Outward-Hound-Dawson-Life-Jacket/dp/B01N4CG5BY/ref=sr\\_1\\_1\\_sspa?s-pet-supplies&ie=UTF8&qid=1531949289&sr=1-1-spons&keywords=vivaglory+dog+life+jacket+xl&psc=1](https://www.amazon.com/Outward-Hound-Dawson-Life-Jacket/dp/B01N4CG5BY/ref=sr_1_1_sspa?s-pet-supplies&ie=UTF8&qid=1531949289&sr=1-1-spons&keywords=vivaglory+dog+life+jacket+xl&psc=1).

“Vivaglory Neoprene Dog Life Jacket.” Found on line Sep. 25, 2019 at www.amazon.com. Product reviewed May 9, 2018. Retrieved from URL: <https://www.amazon.com/Nivaglory-Neoprene-Reflective-Skin-Friendly-Superior/dp/B076J5CZ7T> (Year: 2018).

“Facebook—Vivaglory added a new photo.” Found online Sep. 25, 2019 at www.facebook.com. Page dated Jun. 21, 2018. Retrieved

(56)

**References Cited**

OTHER PUBLICATIONS

from URL: <https://www.facebook.com/Nivaglorypet/photos/a.1686085198106627/1686085254773288/?type=3&theater> (Year: 2018).  
“Outward Hound Dawson Dog Life Jacket.” Found on line Sep. 25, 2019 at [www.amazon.com](http://www.amazon.com). Page dated Jul. 23, 2015. Retrieved from URL: <https://tinyurl.com/yx93gabk> (Year: 2015).  
“Haocoo Dog Life Jacket.” Found on line Sep. 25, 2019 at [www.amazon.com](http://www.amazon.com). Product reviewed Mar. 14, 2017. Retrieved from URL: [https://www.amazon.com/dp/B01HJACGDM/ref=psdc\\_3024173011\\_t2\\_B076J5GDMJ](https://www.amazon.com/dp/B01HJACGDM/ref=psdc_3024173011_t2_B076J5GDMJ) (Year: 2017).

\* cited by examiner

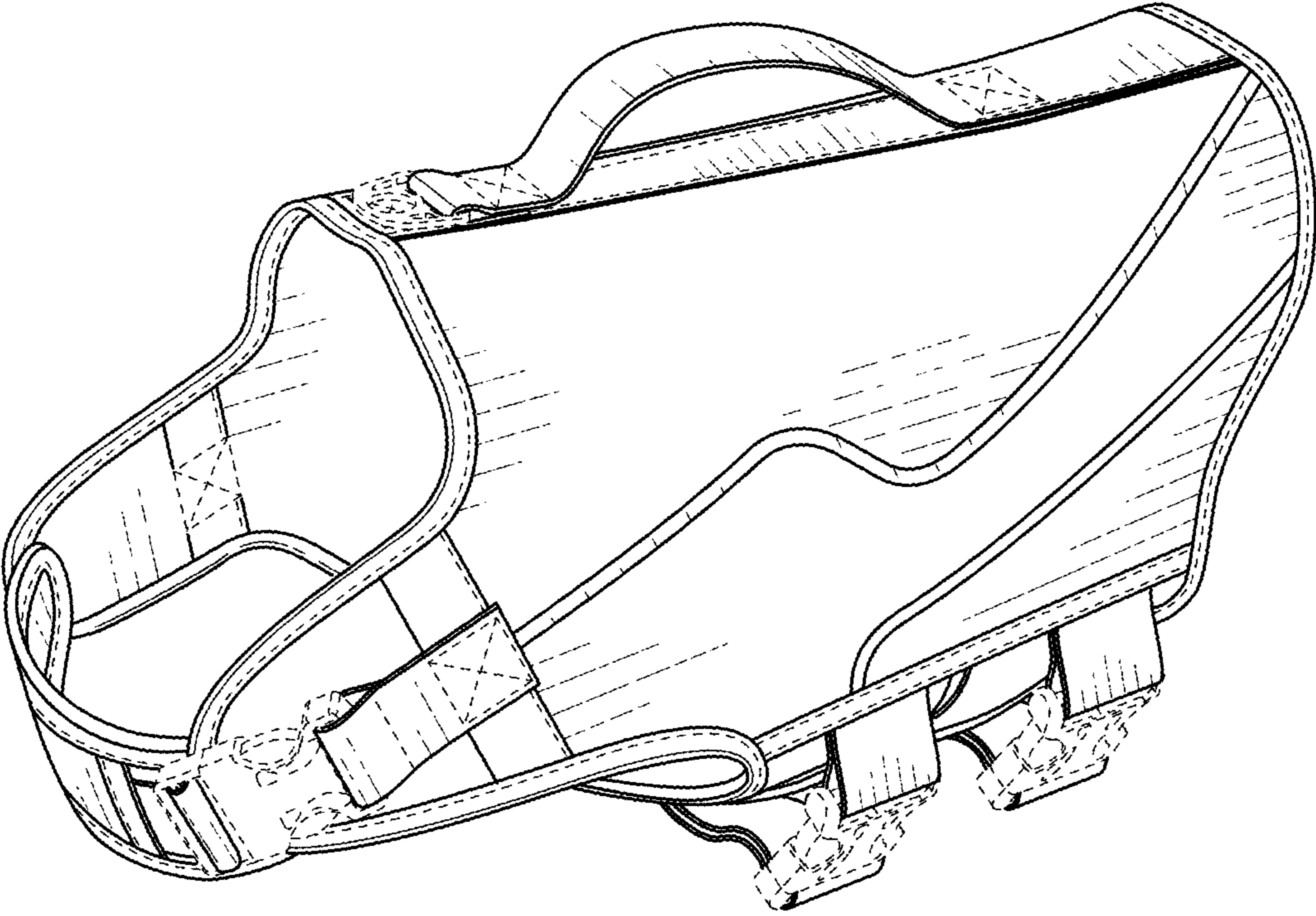

FIG. 1

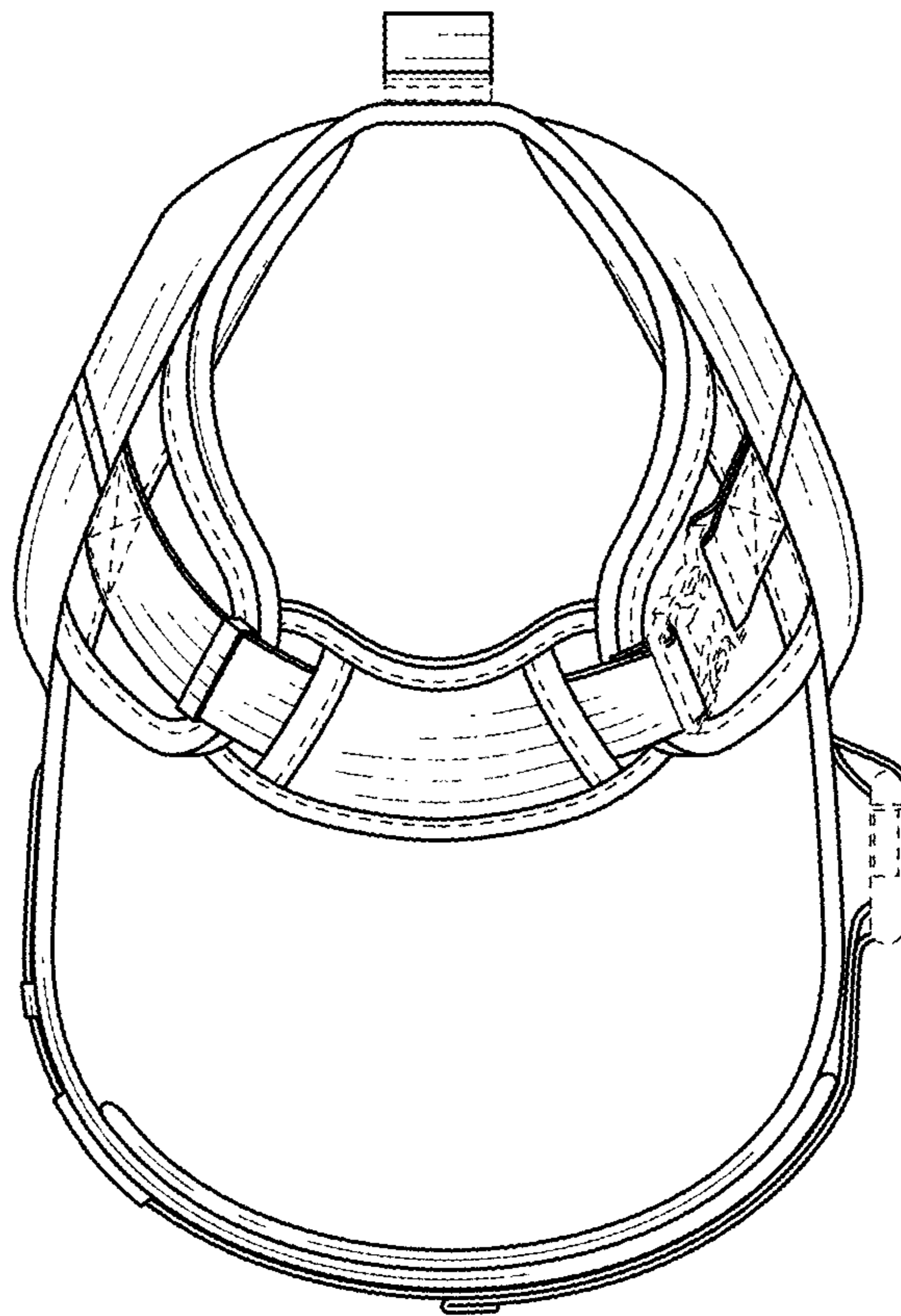

FIG. 2

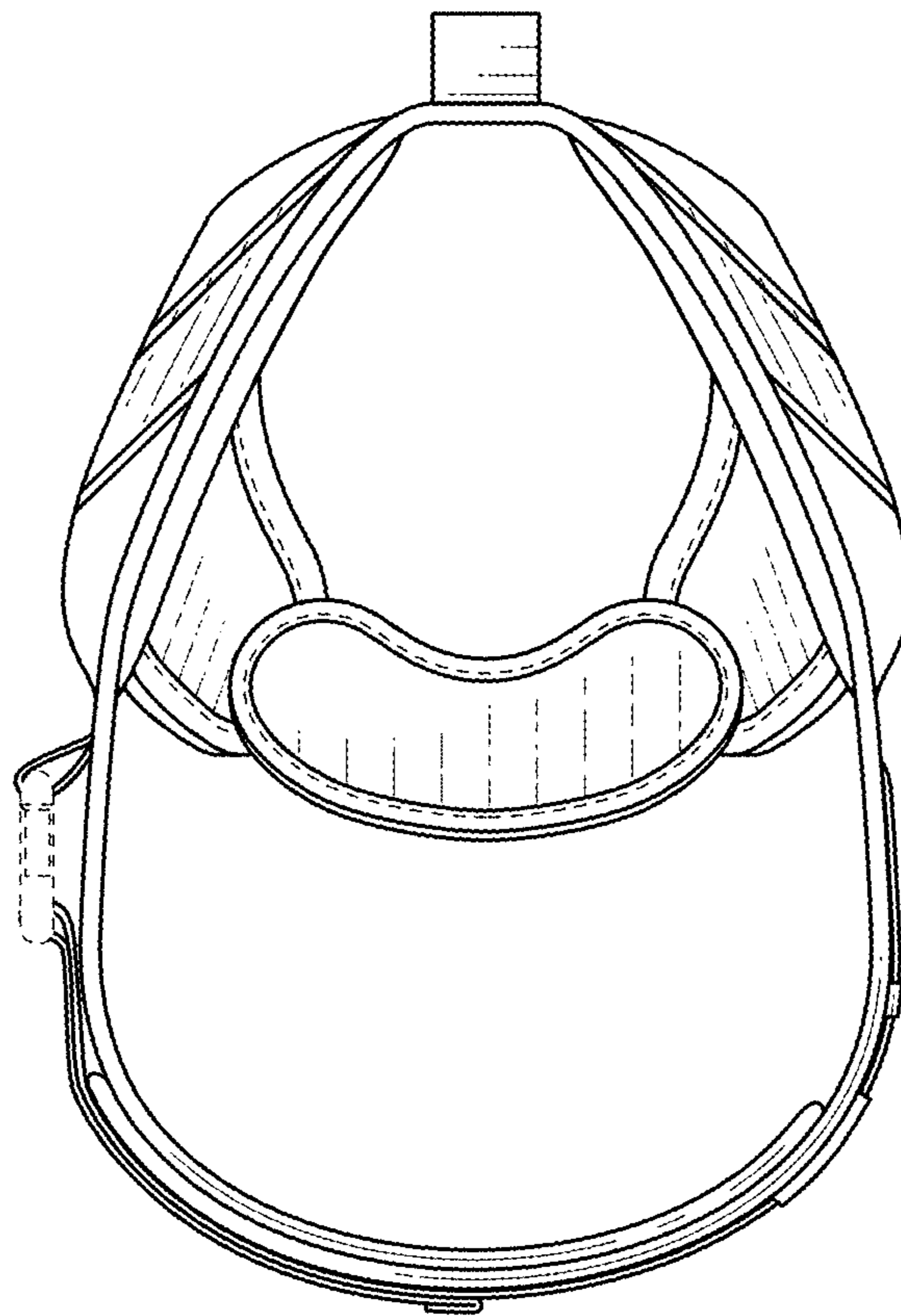

FIG. 3

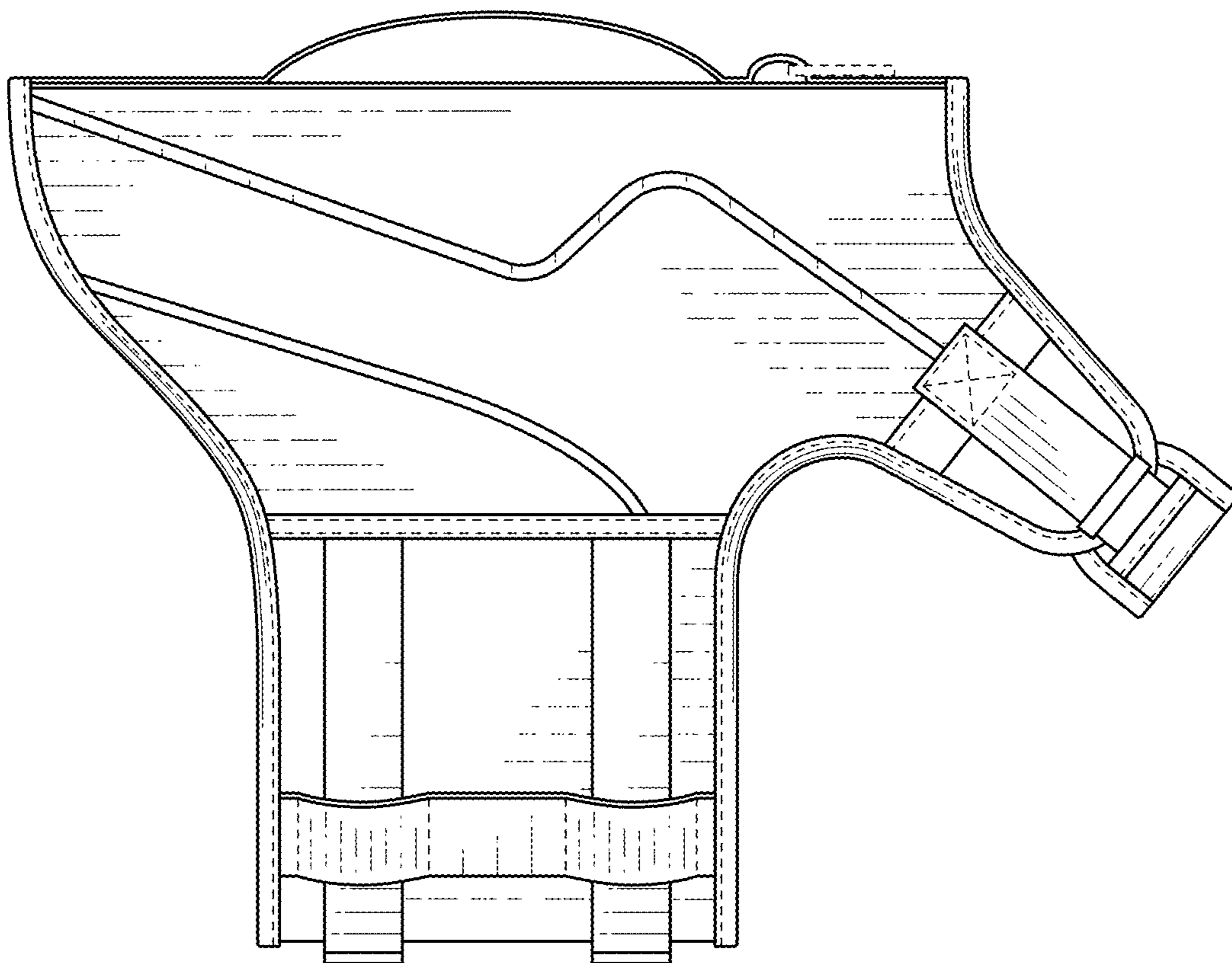

FIG. 4

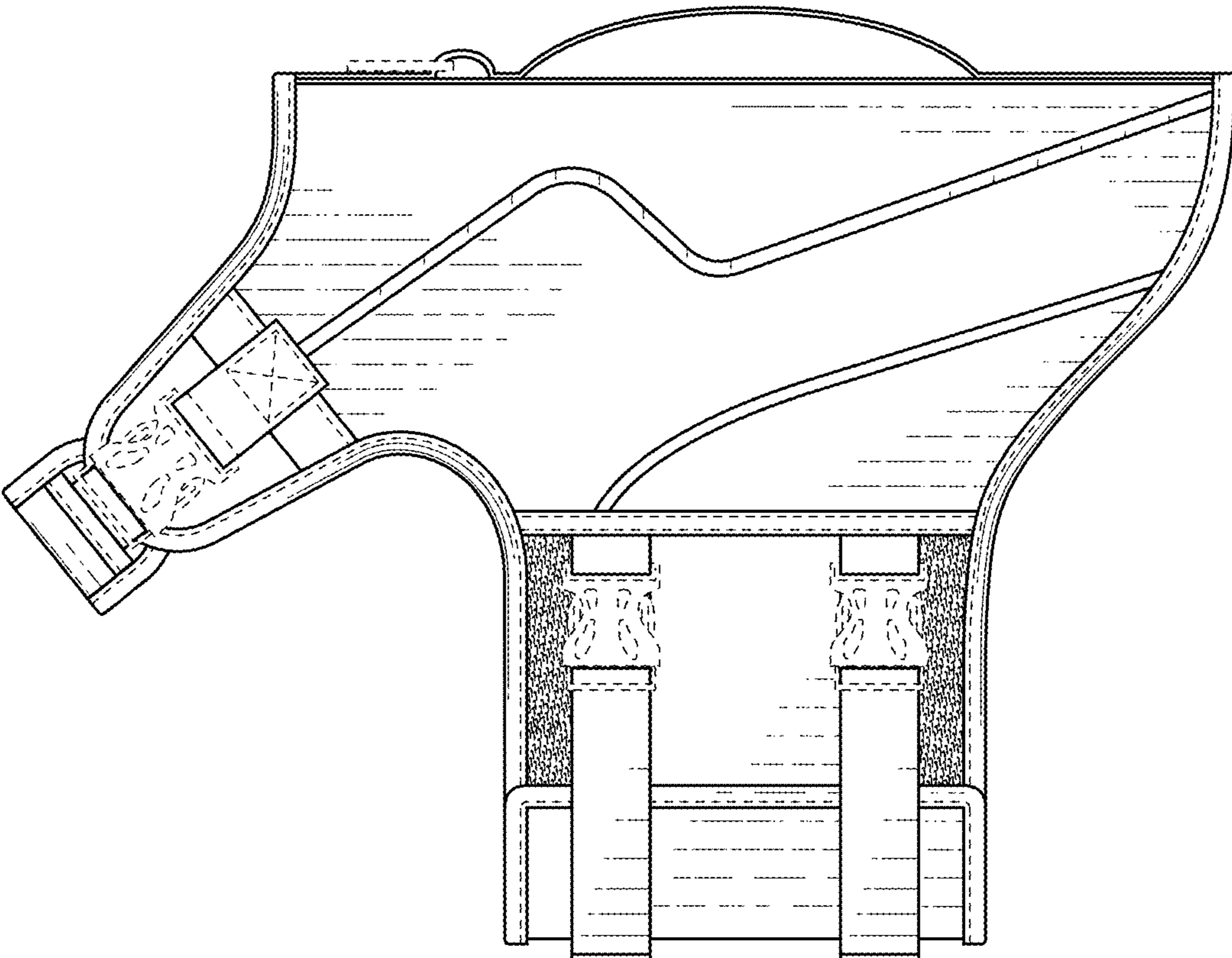

FIG. 5



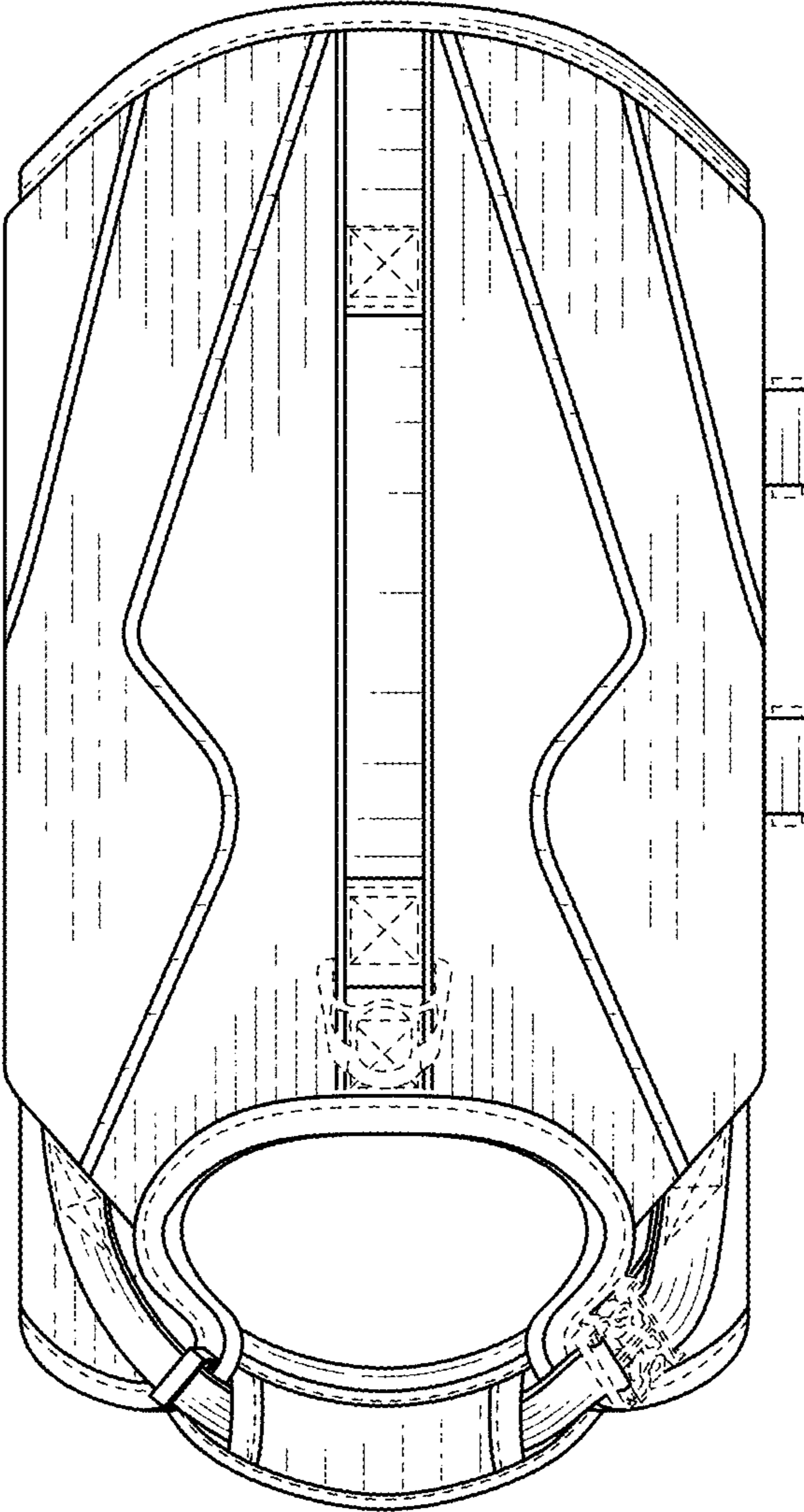

FIG. 6

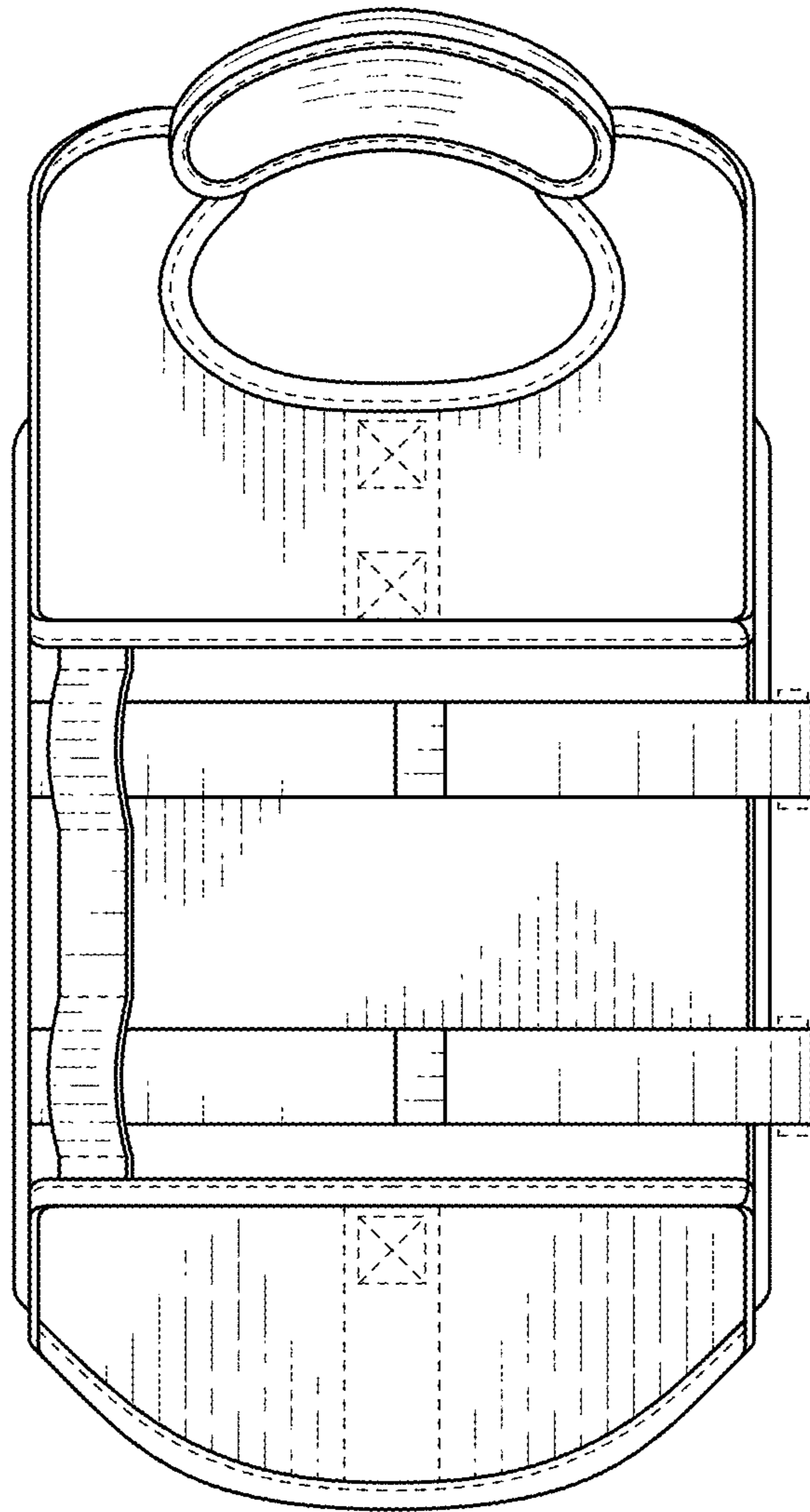

FIG. 7

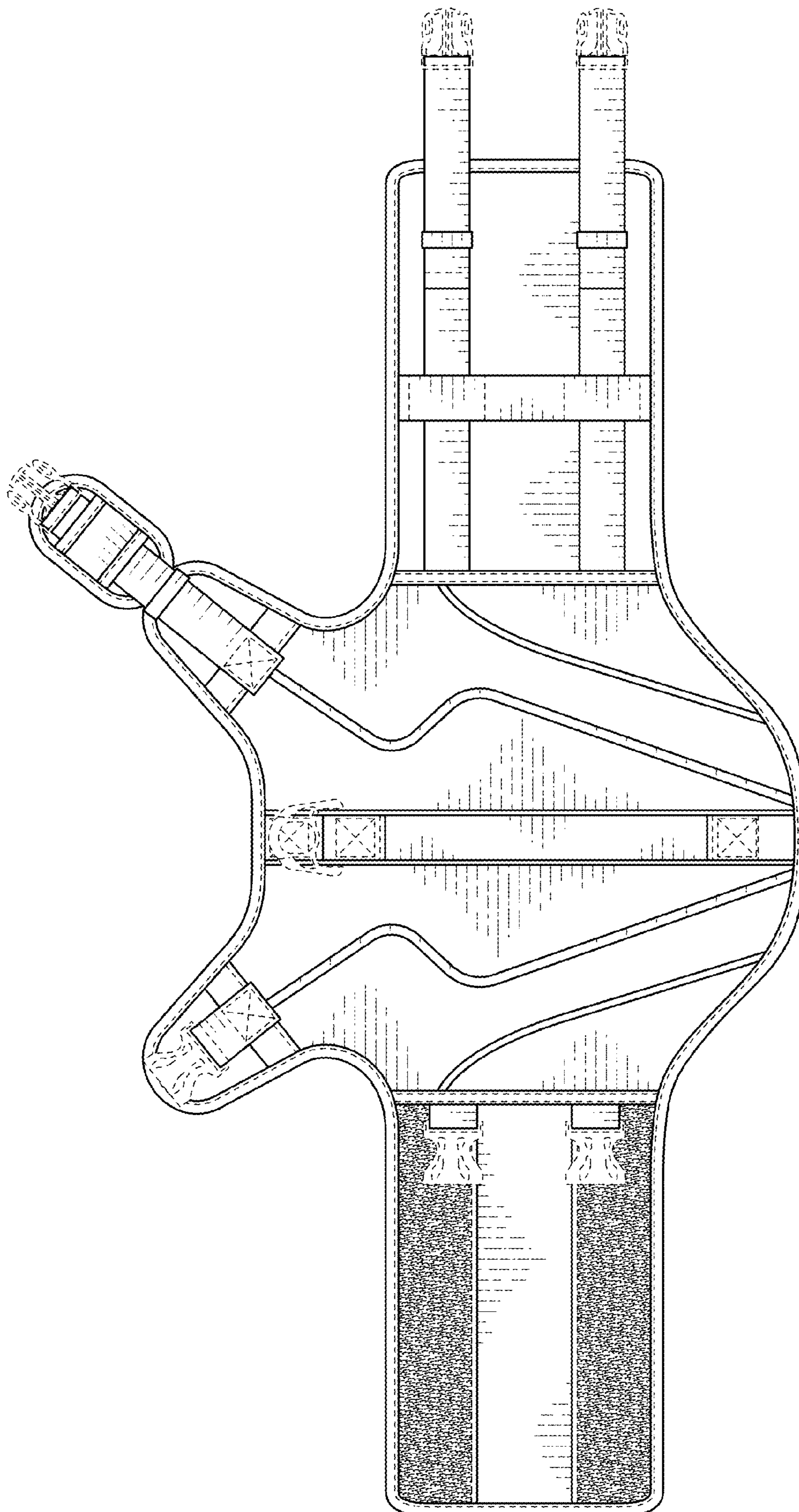

FIG. 8

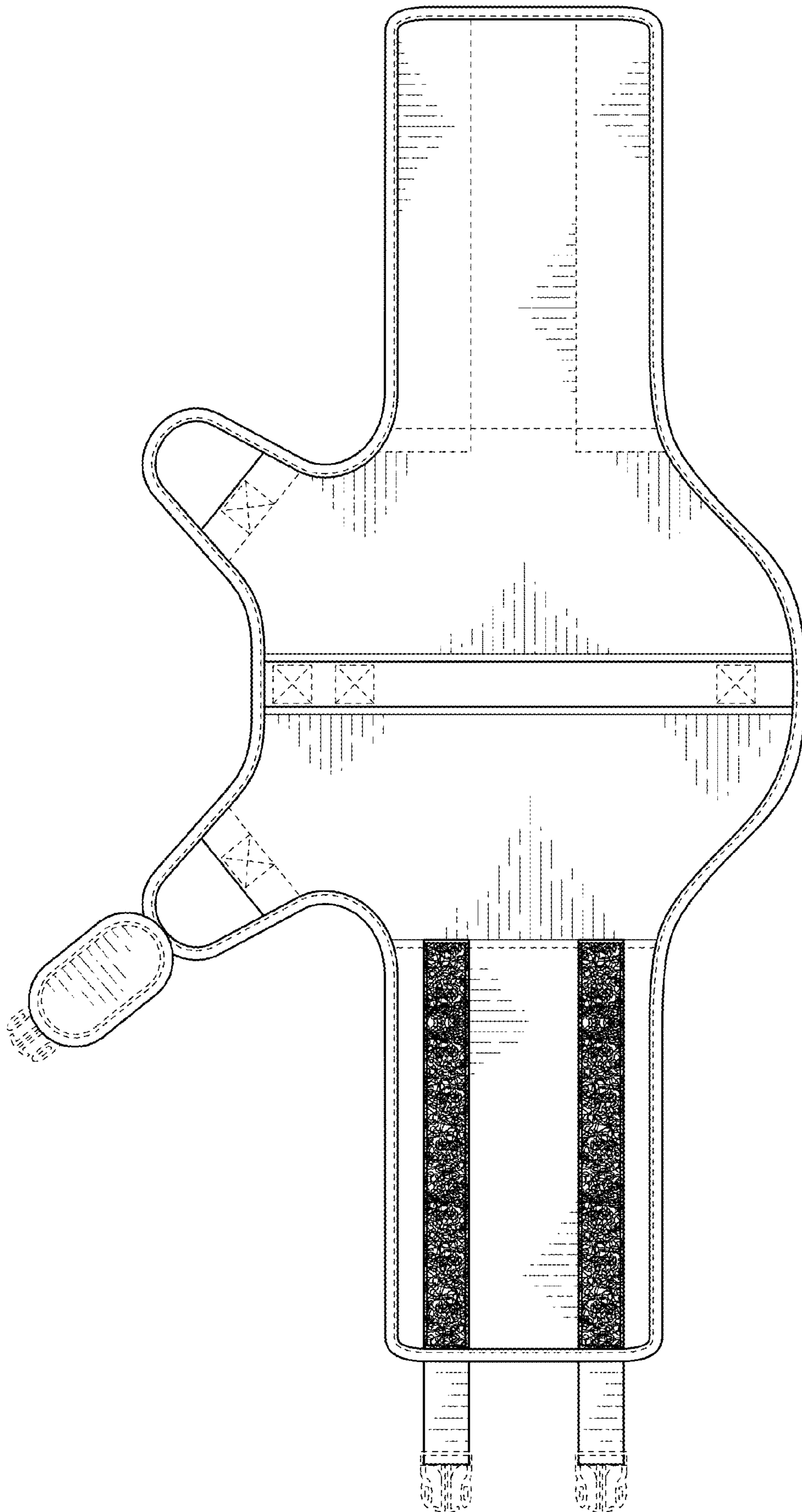

FIG. 9