



US00D987875S

(12) **United States Design Patent** (10) **Patent No.:** **US D987,875 S**  
**Peng** (45) **Date of Patent:** **\*\* May 30, 2023**

(54) **SOLAR LAMP**

(71) Applicant: **Wen Peng**, Shaoshan (CN)

(72) Inventor: **Wen Peng**, Shaoshan (CN)

(73) Assignee: **Wen Peng**, Shaoshan (CN)

(\*\*) Term: **15 Years**

(21) Appl. No.: **29/777,373**

(22) Filed: **Apr. 6, 2021**

(51) **LOC (14) Cl.** ..... **25-03**

(52) **U.S. Cl.**  
USPC ..... **D26/67**

(58) **Field of Classification Search**  
USPC ..... D26/63, 67-70, 85  
CPC .. F21S 8/081; F21S 8/083; F21S 8/088; F21S  
9/03; F21S 9/035; F21S 9/037; F21V  
21/0824; F21V 21/26; F21W 2111/02;  
F21W 2111/023; F21W 2131/109  
See application file for complete search history.

(56) **References Cited**

**U.S. PATENT DOCUMENTS**

- 1,668,799 A \* 5/1928 Bergan ..... G09F 13/06  
362/812
- D463,826 S \* 10/2002 Garcia ..... D20/17
- D496,485 S \* 9/2004 Stekelenburg ..... D20/42
- D529,217 S \* 9/2006 Wood ..... G09F 13/04  
D26/67
- D553,784 S \* 10/2007 Estes ..... D26/92
- D631,514 S \* 1/2011 Baker ..... D20/17
- D825,450 S \* 8/2018 Felder ..... D13/102
- D901,742 S \* 11/2020 Fu ..... D26/67
- D902,465 S \* 11/2020 Harders ..... D26/67
- D918,435 S \* 5/2021 Liang ..... D26/24
- D920,228 S \* 5/2021 He ..... D13/102
- D932,930 S \* 10/2021 Smith ..... D10/111

- D938,083 S \* 12/2021 Cai ..... D26/67
- D945,667 S \* 3/2022 Yang ..... D13/102
- 2005/0076551 A1\* 4/2005 Silverstone ..... G09F 13/04  
40/568

**OTHER PUBLICATIONS**

Deerdance, Solar Illuminated Outdoor Address Plaque. First Available May 10, 2021. Searched on Jan. 9, 2023. [<https://www.amazon.com/dp/B094HNWP53/>] (Year: 2021).\*

Nex, Solar Powered Light. First available unknown. Searched on Oct. 12, 2022. [<https://www.lowes.com/pd/NEX-Waterproof-Solar-Powered-House-Numbers-Light-for-Outside-Home-Yard-Street/5013084429>] (Year: 2022).\*

MAXvolador, Solar Illuminated Address Plaque. First available Jul. 29, 2021. Searched on Jan. 9, 2023. [<https://www.amazon.com/Address-Lighted-Waterproof-Illuminated-Driveway/dp/B0928Z4GPM/>] (Year: 2021).\*

\* cited by examiner

*Primary Examiner* — W. A. Teddy Falloway  
*Assistant Examiner* — Melissa Adriane Santos  
 (74) *Attorney, Agent, or Firm* — Nitin Kaushik

(57) **CLAIM**

The ornamental design for a solar lamp, as shown and described.

**DESCRIPTION**

FIG. 1 is a perspective view of a solar lamp showing my new design;  
 FIG. 2 is another perspective view thereof;  
 FIG. 3 is a front elevational view thereof;  
 FIG. 4 is a rear elevational view thereof;  
 FIG. 5 is a left side elevational view thereof;  
 FIG. 6 is a right side elevational view thereof;  
 FIG. 7 is a top plan view thereof; and,  
 FIG. 8 is a bottom plan view thereof.  
 The broken lines in the drawings depict portions of the solar lamp that form no part of the claimed design.

**1 Claim, 8 Drawing Sheets**

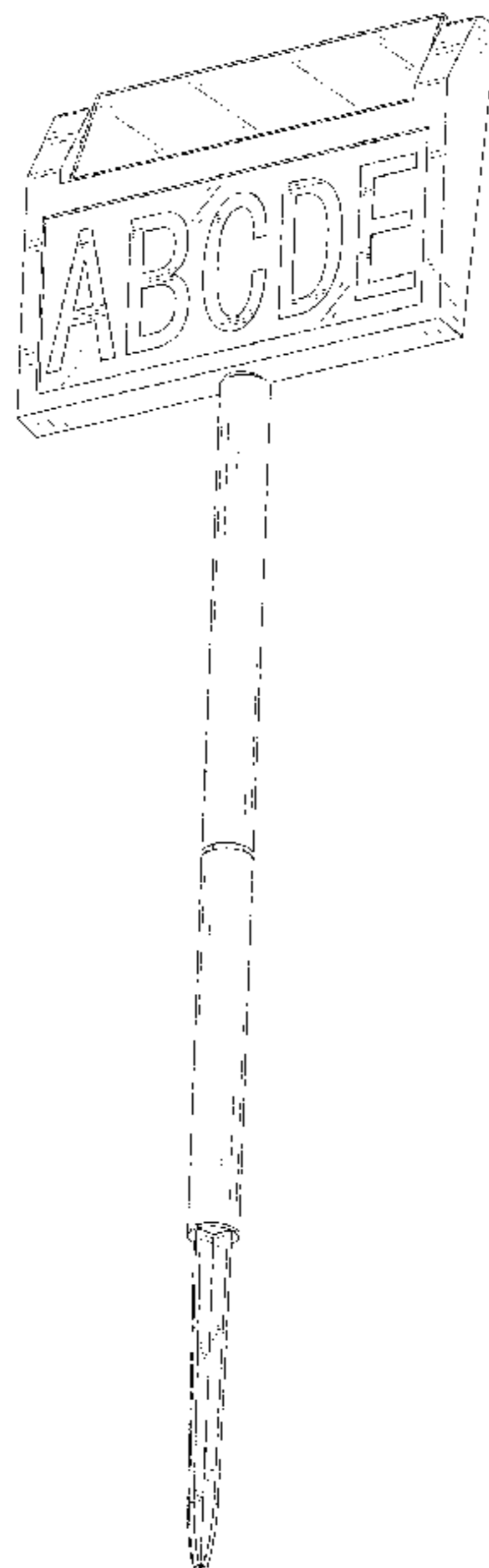

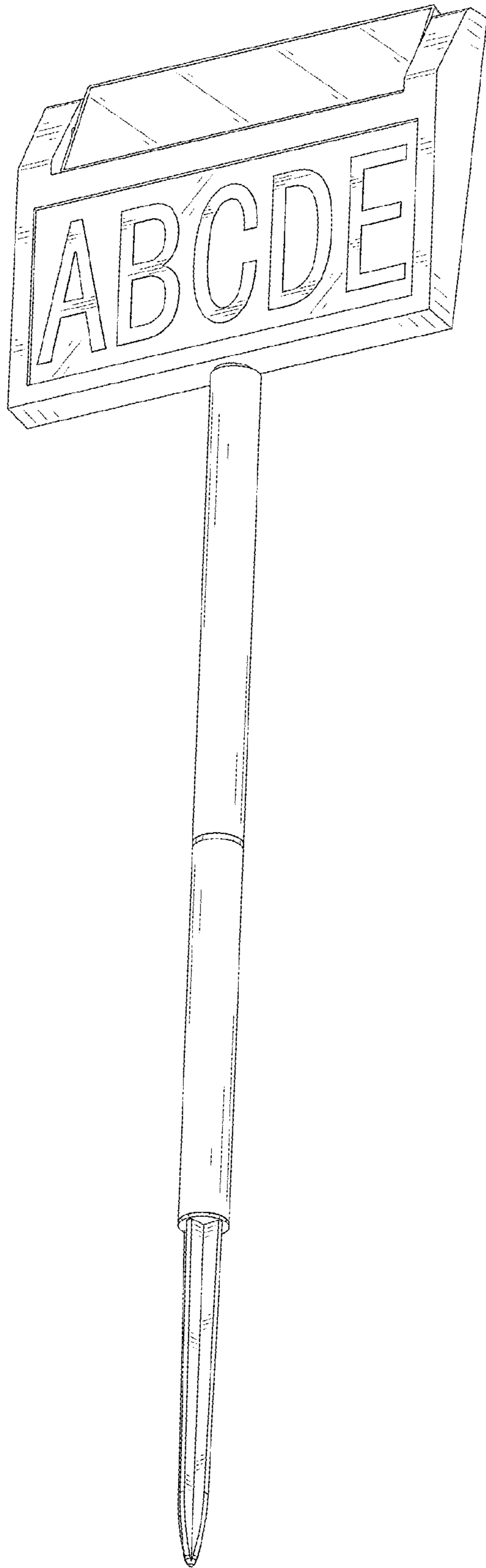

FIG. 1

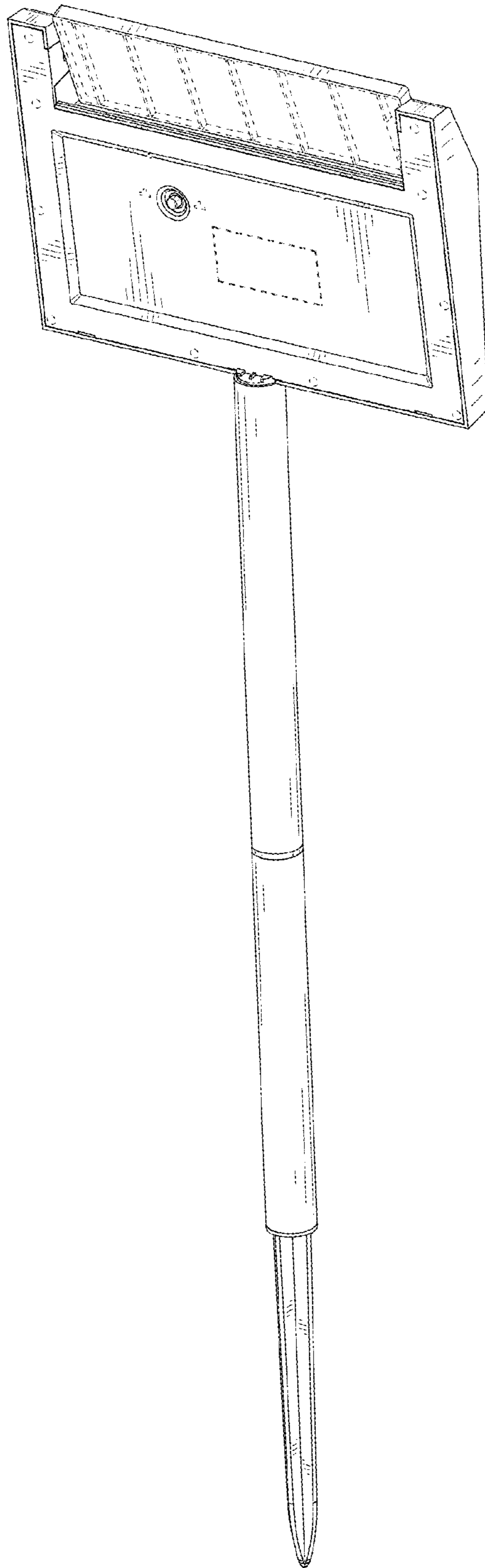

FIG. 2

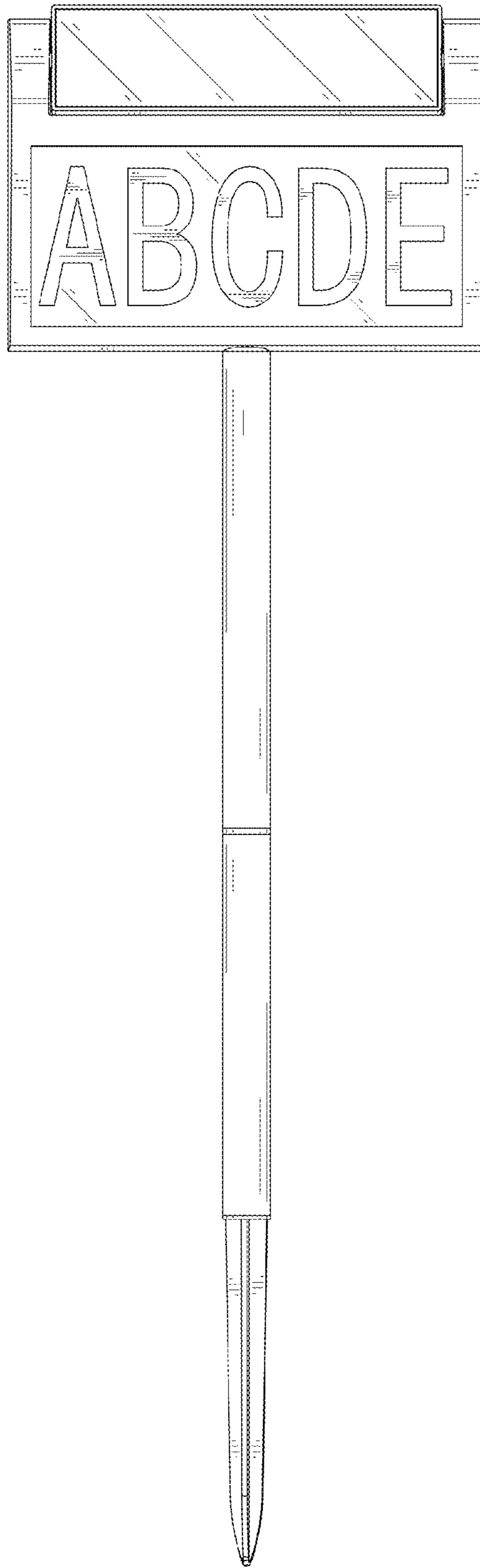

FIG. 3

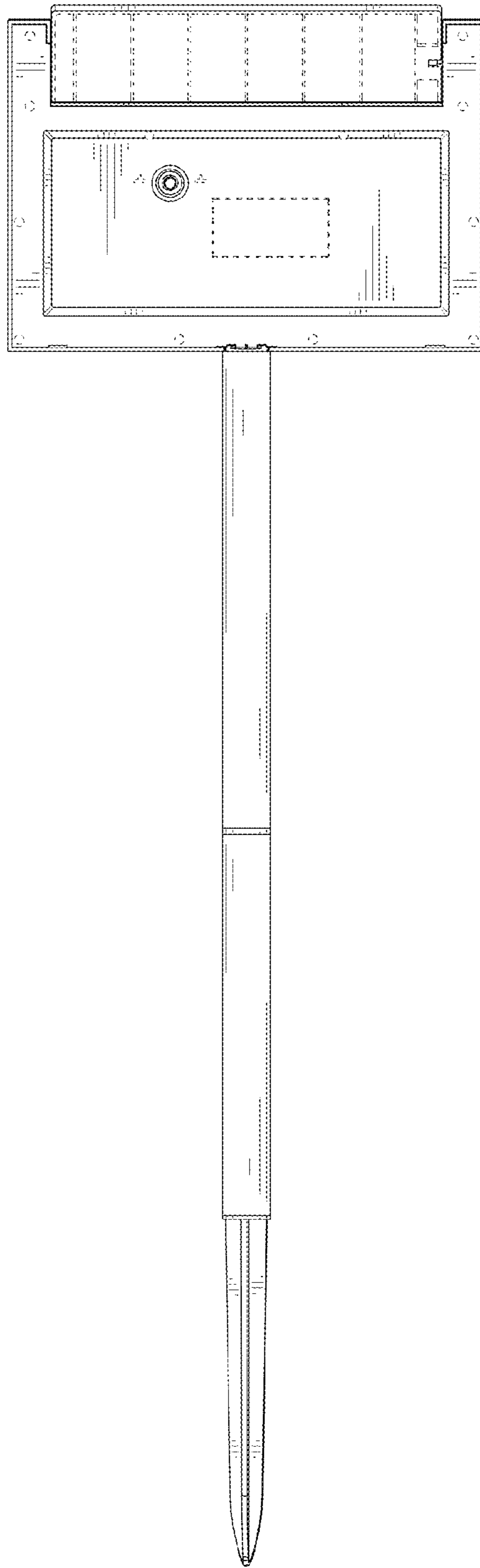

FIG. 4

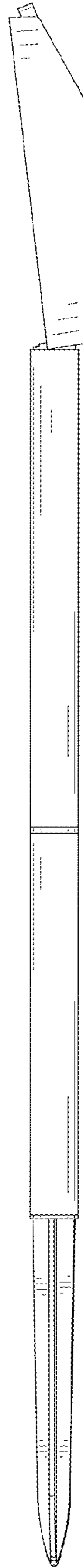

FIG. 5

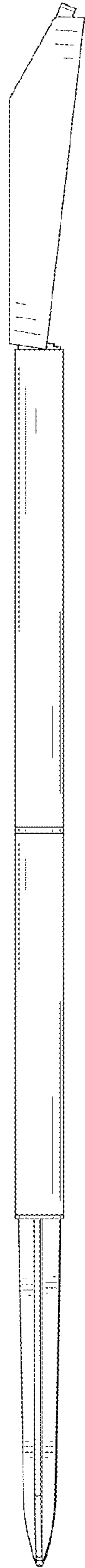

FIG. 6

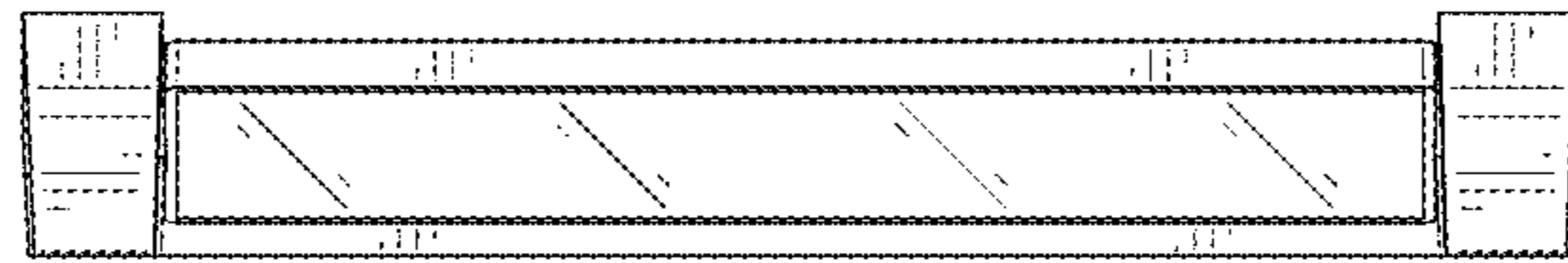

FIG. 7



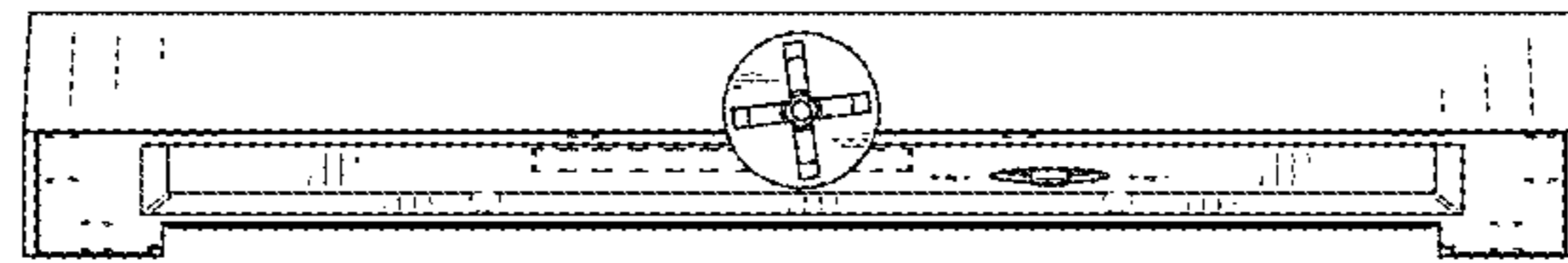

FIG. 8