



US00D987813S

(12) **United States Design Patent**  
**Bornholdt et al.**

(10) **Patent No.:** **US D987,813 S**  
(45) **Date of Patent:** **\*\* May 30, 2023**

(54) **FACE MASK FRAME FOR A RESPIRATORY INTERFACE**

(71) Applicant: **Fisher & Paykel Healthcare Limited**,  
Auckland (NZ)

(72) Inventors: **Melissa Catherine Bornholdt**,  
Auckland (NZ); **Max Leon Betteridge**,  
Auckland (NZ); **Hamish Joshua Rose**,  
Auckland (NZ)

(73) Assignee: **Fisher & Paykel Healthcare Limited**,  
Auckland (NZ)

(\*\*) Term: **15 Years**

(21) Appl. No.: **29/670,741**

(22) Filed: **Nov. 19, 2018**

**Related U.S. Application Data**

(63) Continuation of application No. 29/648,933, filed on  
May 24, 2018, now Pat. No. Des. 837,972, which is  
a continuation of application No. 29/576,701, filed on  
Sep. 6, 2016, now Pat. No. Des. 821,569.

(51) **LOC (14) Cl.** ..... **29-02**

(52) **U.S. Cl.**  
USPC ..... **D24/110.4**

(58) **Field of Classification Search**  
USPC ..... D24/110, 110.1–110.4, 110.6, 127;  
D29/108, 122  
CPC ..... A61M 16/06; A61M 16/0605; A61M  
16/0616; A61M 16/0622; A61M 16/0633;  
A61M 16/0644; A61M 16/0666; A61M  
16/0672; A61M 16/0683

See application file for complete search history.

(56) **References Cited**

**U.S. PATENT DOCUMENTS**

5,662,101 A 9/1997 Ogden et al.  
D586,906 S 2/2009 Stallard et al.

D635,661 S 4/2011 Stallard et al.  
D639,420 S 6/2011 D’Souza et al.  
D652,914 S 1/2012 D’Souza et al.  
D681,192 S 4/2013 D’Souza et al.  
D683,447 S 5/2013 Olsen et al.  
D693,459 S 11/2013 Prentice et al.  
D693,461 S 11/2013 Rothermel

(Continued)

**OTHER PUBLICATIONS**

“Cleaning your F&P Vitera Full Face Mask—AU” posted by F&P  
Healthcare. Youtube. Posting date: Nov. 7, 2019. Retrieval date:  
Feb. 2, 2022. Retrieved from internet: [https://www.youtube.com/watch?v=rJTd\\_xLReqY](https://www.youtube.com/watch?v=rJTd_xLReqY) (Year: 2019).\*

(Continued)

*Primary Examiner* — Daniel J Domino

*Assistant Examiner* — Lee D. Starr

(74) *Attorney, Agent, or Firm* — Knobbe, Martens, Olson  
& Bear, LLP

(57) **CLAIM**

The ornamental design for a face mask frame for a respira-  
tory interface, as shown and described.

**DESCRIPTION**

FIG. 1 is a front perspective view of a face mask frame for  
a respiratory interface.

FIG. 2 is a rear perspective view thereof.

FIG. 3 is a front view thereof.

FIG. 4 is a rear view of thereof.

FIG. 5 is a left side view thereof.

FIG. 6 is a right side view thereof.

FIG. 7 is a top view thereof; and,

FIG. 8 is a bottom view thereof.

The broken lines in the drawings illustrate portions of the  
face mask frame for a respiratory interface which form no  
part of the claimed design.

**1 Claim, 8 Drawing Sheets**

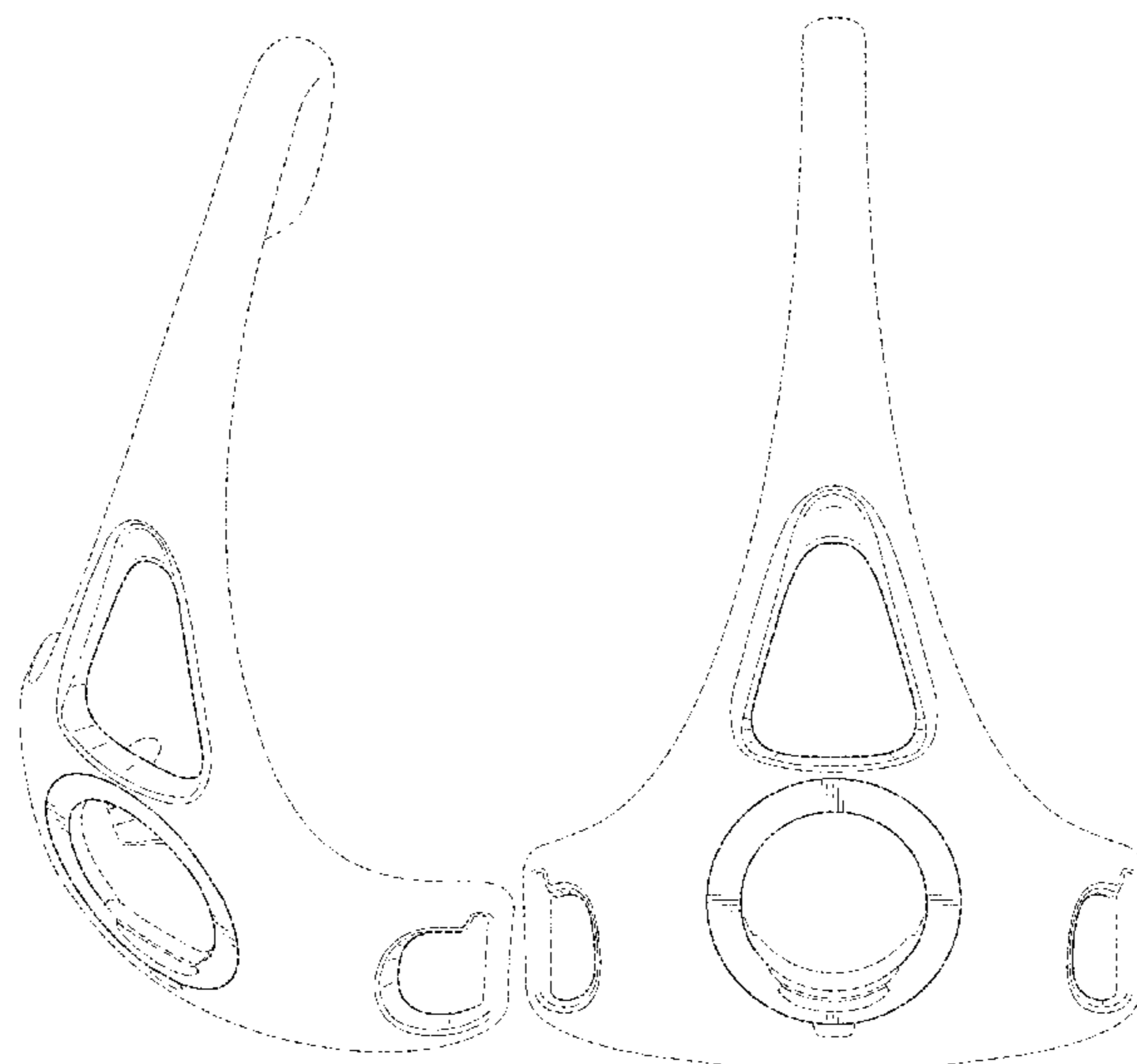

(56)

**References Cited**

U.S. PATENT DOCUMENTS

D716,440 S 10/2014 D'Souza et al.  
 D753,813 S 4/2016 Ozolins et al.  
 D782,030 S 3/2017 Prentice et al.  
 D782,031 S 3/2017 Prentice et al.  
 D784,516 S 4/2017 Prentice et al.  
 D809,132 S 1/2018 Bornholdt et al.  
 D809,649 S 2/2018 Bornholdt et al.  
 D814,020 S 3/2018 Bornholdt et al.  
 D821,569 S 6/2018 Bornholdt et al.  
 D824,021 S 7/2018 Prentice et al.  
 D824,511 S 7/2018 Prentice et al.  
 D837,972 S \* 1/2019 Bornholdt ..... D24/110.4  
 D882,066 S \* 4/2020 Niccol ..... D24/110.4  
 D892,307 S \* 8/2020 Wang ..... D24/110.4  
 D958,969 S \* 7/2022 Prentice ..... D24/110.4  
 2004/0134497 A1 7/2004 Gunaratnam et al.  
 2007/0044804 A1 3/2007 Matula, Jr. et al.  
 2014/0305433 A1 10/2014 Rothermel  
 2016/0008558 A1 1/2016 Huddart et al.

2016/0067442 A1 3/2016 Salmon et al.  
 2016/0220781 A1 8/2016 Arrowsmith et al.  
 2016/0354572 A1 12/2016 Lim et al.  
 2017/0065786 A1 3/2017 Stephenson et al.  
 2017/0157353 A1 6/2017 Olsen et al.  
 2018/0185598 A1 7/2018 Olsen et al.  
 2018/0207384 A1 7/2018 Zhou et al.  
 2018/0207389 A1 7/2018 Fyfe et al.  
 2018/0214656 A1 8/2018 McLaren  
 2019/0160249 A1 \* 5/2019 Rose ..... A61M 16/0683  
 2020/0108989 A1 \* 4/2020 Hammer ..... B65D 5/5021  
 2020/0324150 A1 \* 10/2020 Nelson ..... A61M 16/0825  
 2021/0001072 A1 \* 1/2021 Lim ..... A61M 16/0622  
 2021/0106780 A1 \* 4/2021 Nelson ..... A61M 16/0683  
 2021/0187234 A1 \* 6/2021 Tebbutt ..... A61M 16/0683

OTHER PUBLICATIONS

U.S. Appl. No. 29/576,701, filed Sep. 6, 2016, Bornholdt.  
 Fisher & Paykel Healthcare Limited, Simplus Full Face Mask,  
 185048005 REVA, 2012.

\* cited by examiner

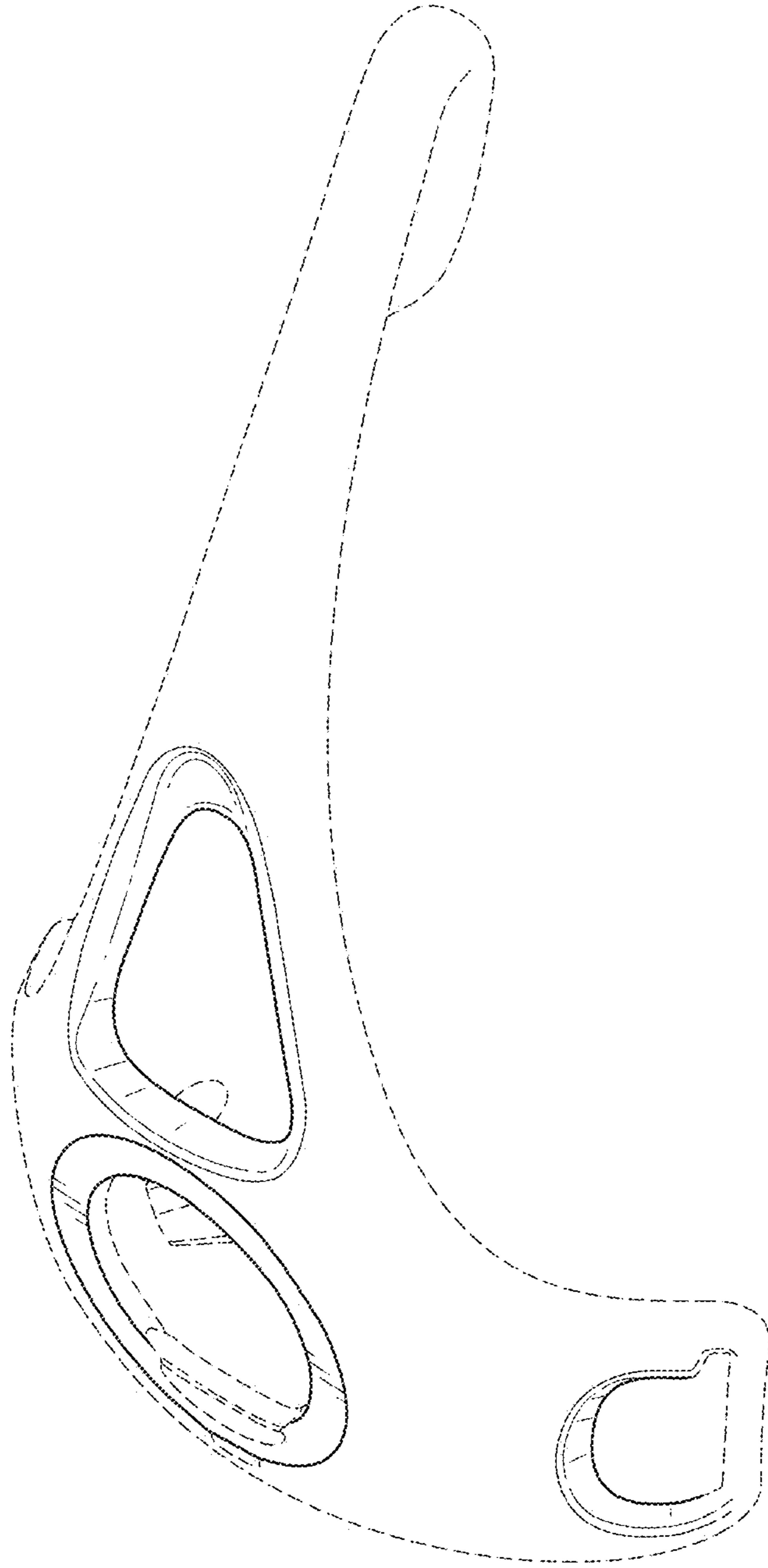
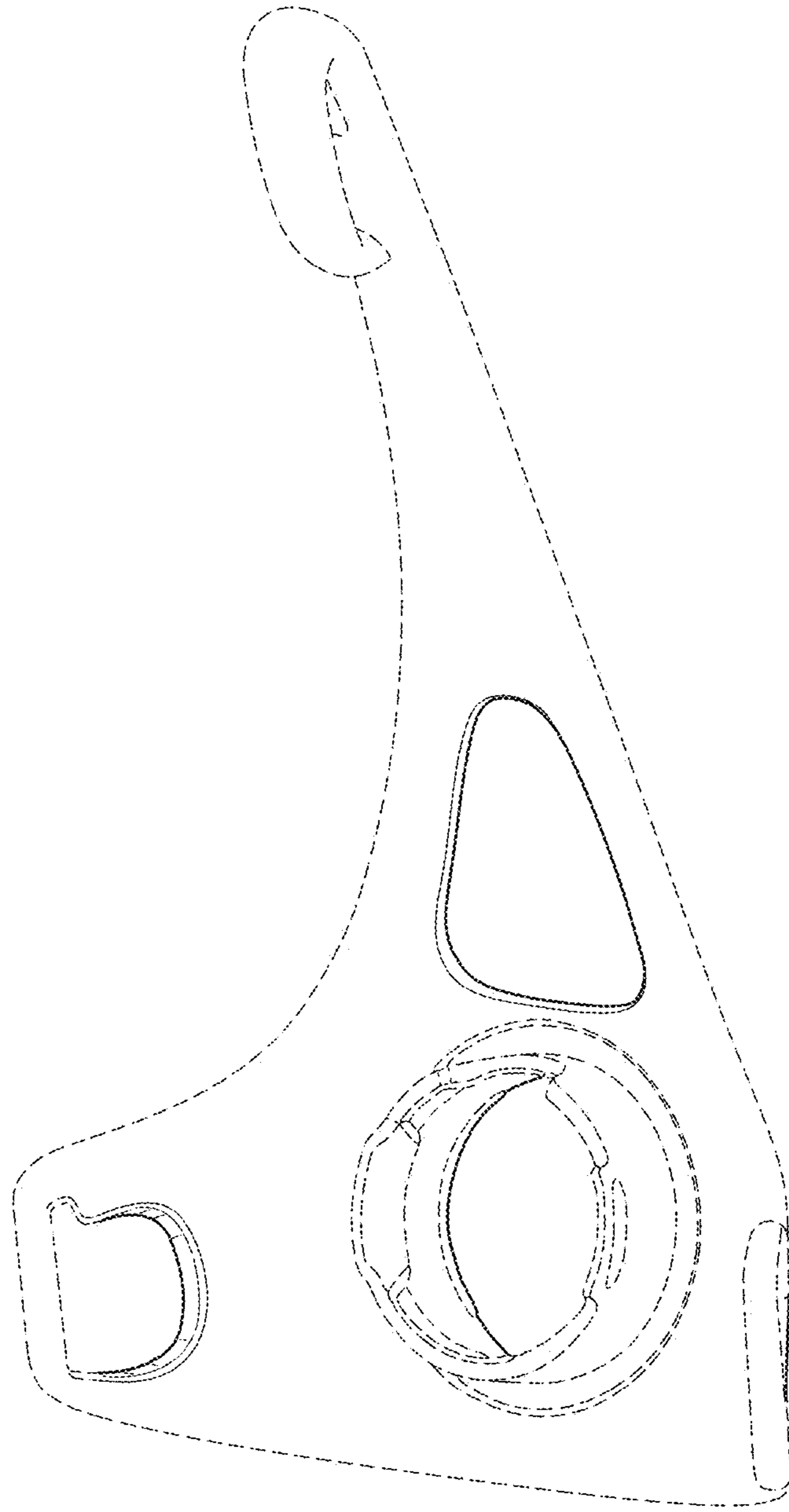

FIG. 1



*FIG. 2*

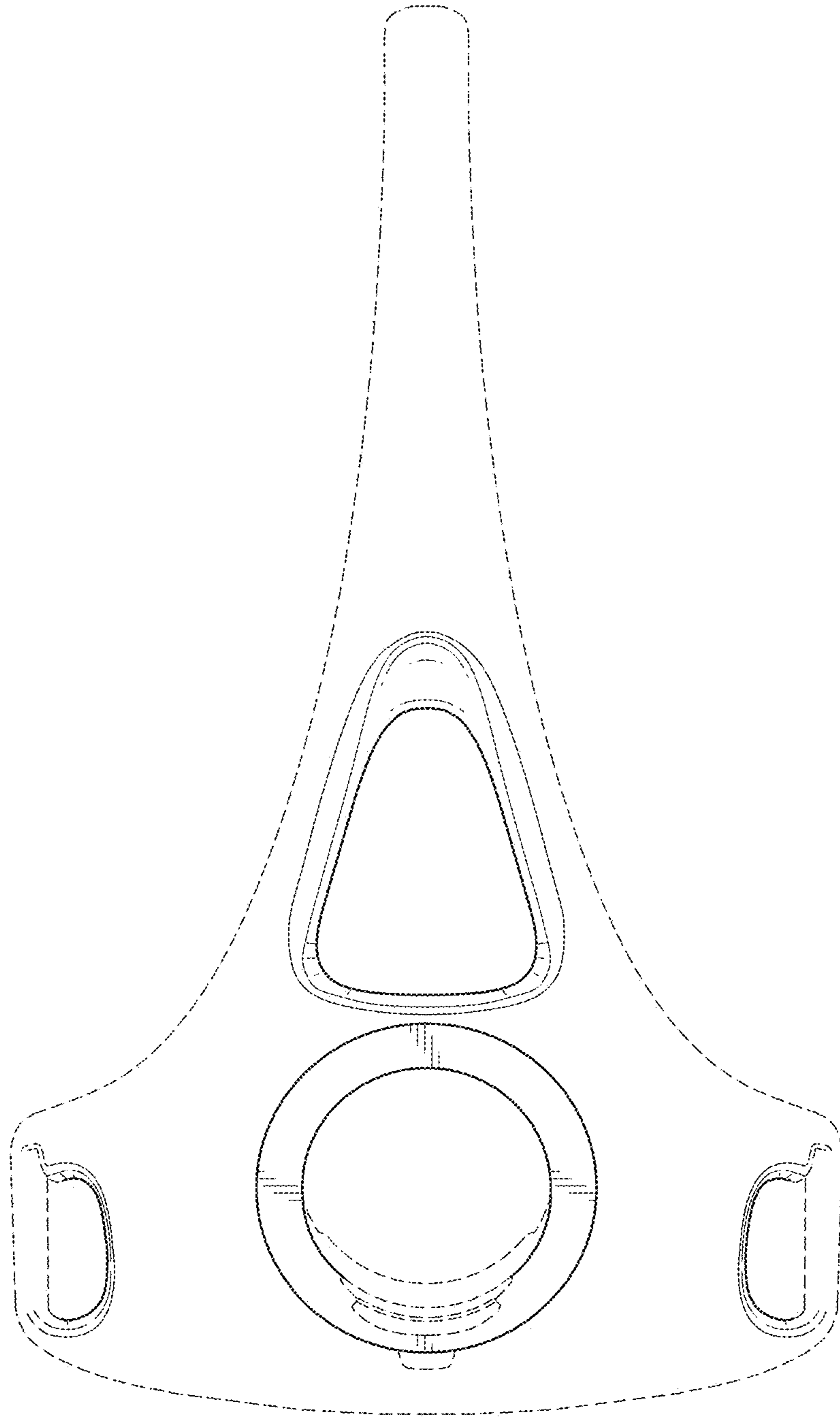

FIG. 3

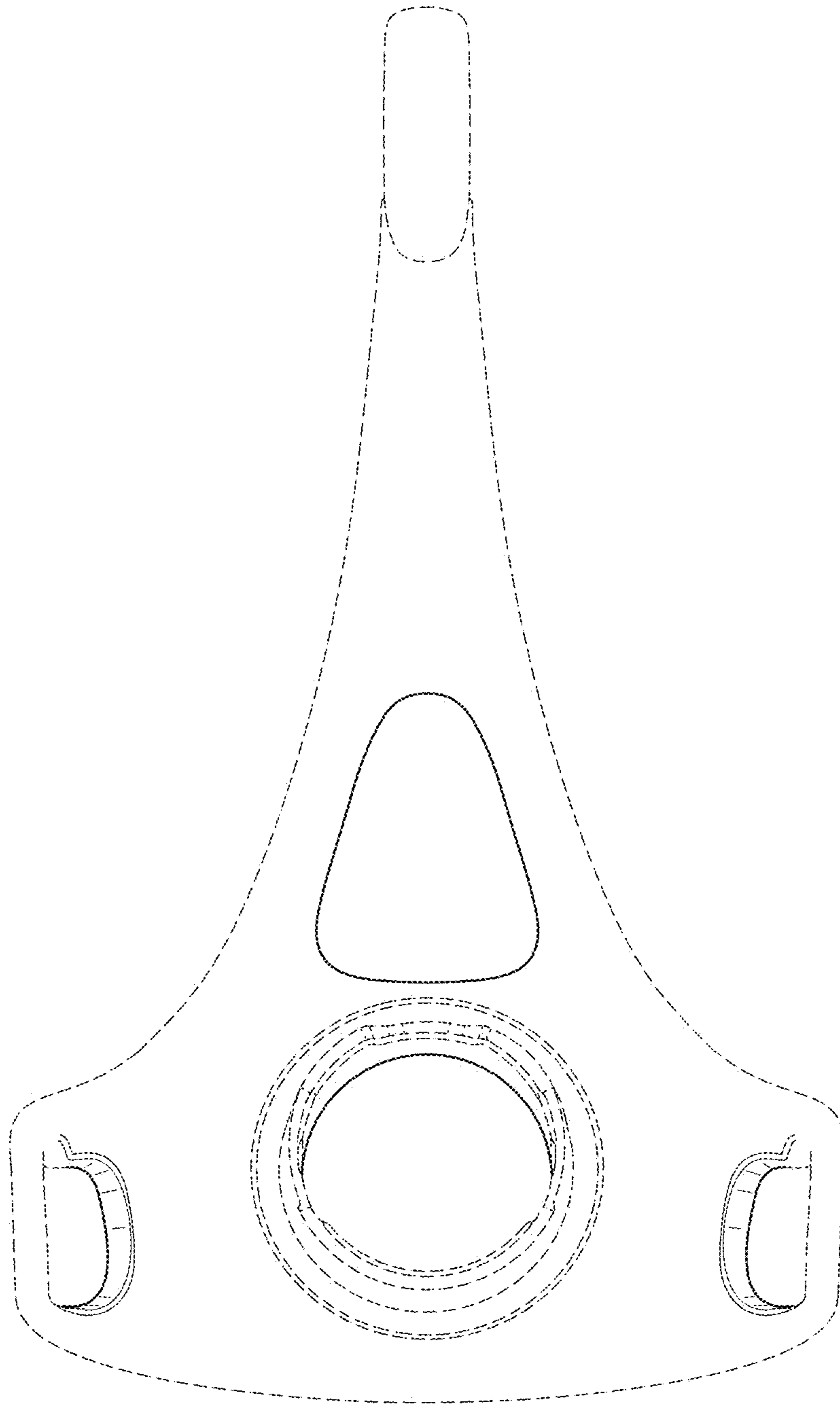
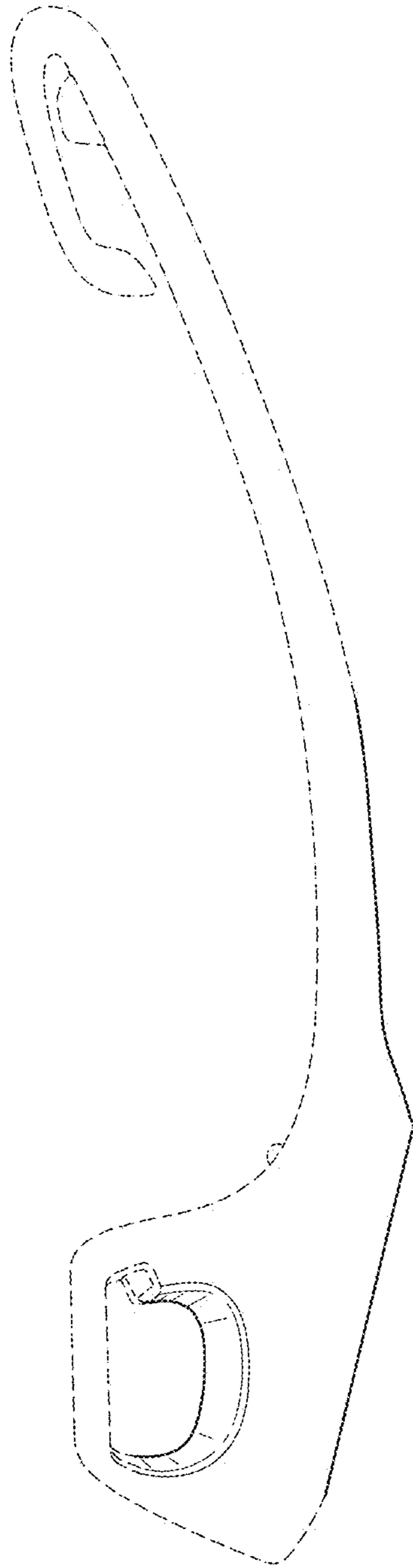

FIG. 4



*FIG. 5*

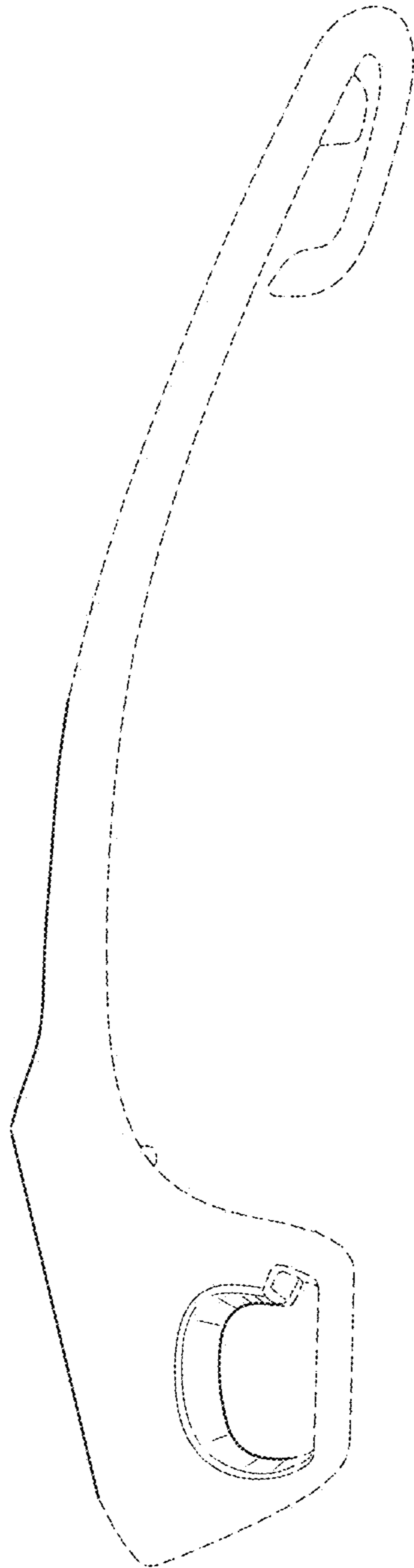
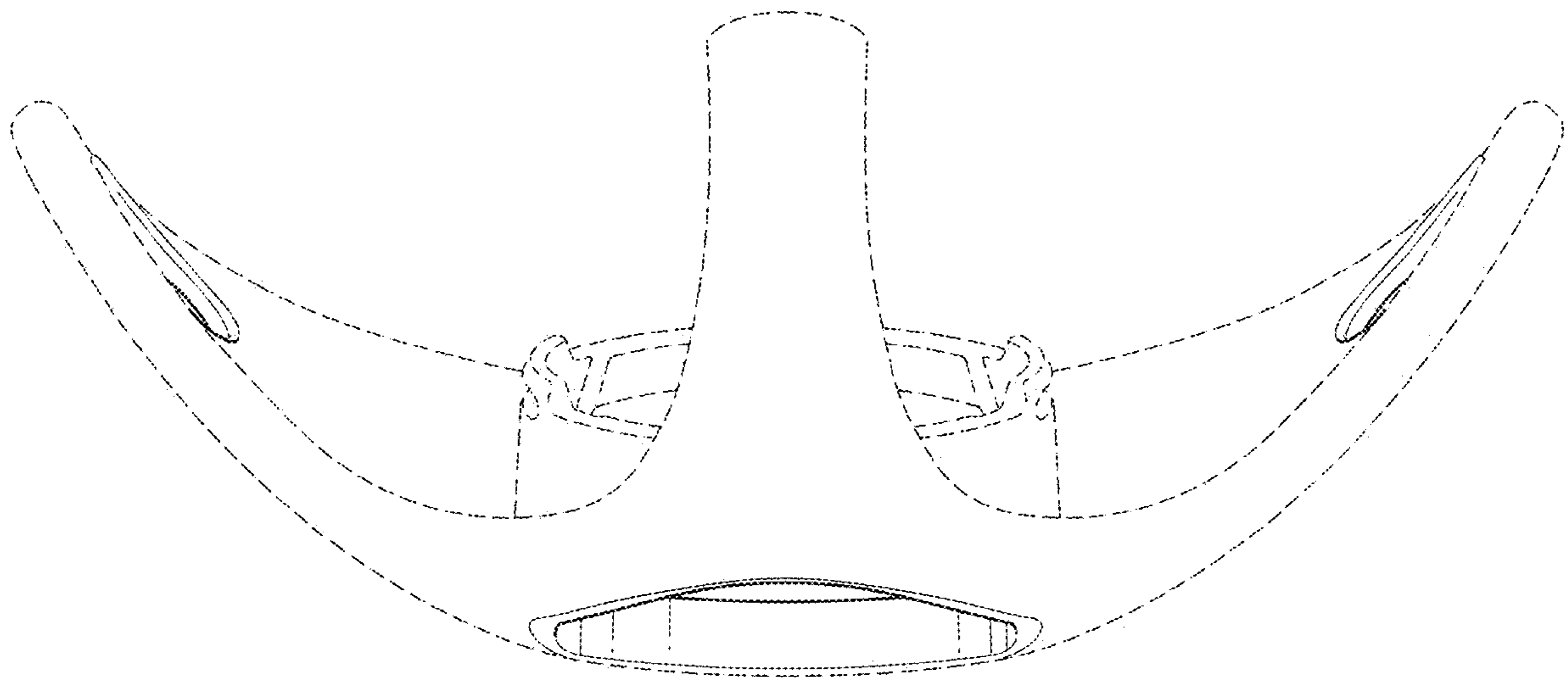
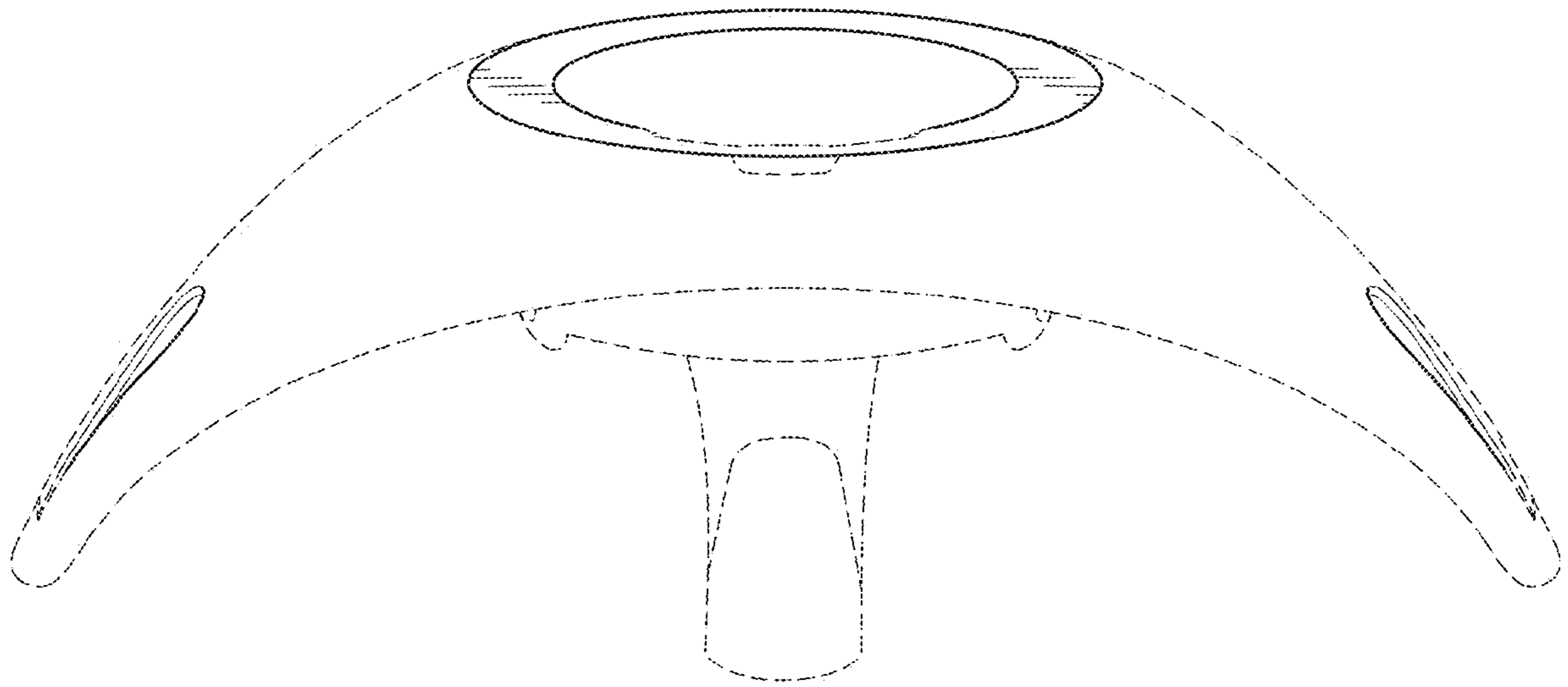

FIG. 6





*FIG. 7*



*FIG. 8*