



US00D987804S

(12) **United States Design Patent**
Chen et al.

(10) **Patent No.:** **US D987,804 S**
(45) **Date of Patent:** **** May 30, 2023**

(54) **AIR PURIFIER**

FOREIGN PATENT DOCUMENTS

(71) Applicant: **Healthlead Corporation Limited**,
Shenzhen (CN)

CN 202130290551.7 * 9/2021
CN 202130694080.6 * 3/2022

(72) Inventors: **Yaogang Chen**, Shenzhen (CN);
Zhixue Zou, Shenzhen (CN);
Hongzeng Zhang, Shenzhen (CN)

OTHER PUBLICATIONS

(73) Assignee: **Healthlead Corporation Limited**,
Shenzhen (CN)

Yiou HY3800 Air Purifier. Catalogue [Online]. Amazon Standard ID# B08RK4BT6D. Amazon.com 2020. [Date First Available {Apr. 5, 2020}][Retrieved on Jan. 31, 2023]. Retrieved from the Internet: <URL:https://www.amazon.com/Purifiers-Premium-Desktop-Purifier-Filtration/dp/B0BKLL3DXB> (Year: 2020).*

(**) Term: **15 Years**

Afloia Q10 Air Purifier. Catalogue [Online]. Amazon Standard ID# B08BBYPZQJ. Amazon.com 2020. [Date First Available {Jun. 17, 2020}][Retrieved on Jan. 31, 2023]. Retrieved from the Internet: <URL:https://www.amazon.com/Afloia-Purifier-Dehumidifier-Allergies-Basements/dp/B08BBYPZQJ?th=1B> (Year: 2020).*

(21) Appl. No.: **29/795,983**

(Continued)

(22) Filed: **Jun. 22, 2021**

(30) **Foreign Application Priority Data**

Primary Examiner — Janice Hallmark

Assistant Examiner — Adedoyin Taiwo Odeyale

Feb. 2, 2021 (CN) 202130075316.8

(74) *Attorney, Agent, or Firm* — Westbridge IP LLC

(51) **LOC (14) Cl.** **23-04**

(57) **CLAIM**

(52) **U.S. Cl.**
USPC **D23/364**

The ornamental design for an air purifier, as shown and described.

(58) **Field of Classification Search**
USPC D23/314, 332, 333, 335, 336, 355, 356,
D23/364, 365, 366, 378
CPC F24F 1/0022; F24F 3/14; F24F 6/06; F24F
8/80; B01D 46/00281; B01D 46/0043;
A61L 2209/12; A61L 2209/14
See application file for complete search history.

DESCRIPTION

(56) **References Cited**

U.S. PATENT DOCUMENTS

D835,765 S * 12/2018 Chen D23/364
D918,371 S * 5/2021 Zeng D23/364
D948,018 S * 4/2022 Li D23/364
D953,509 S * 5/2022 Yan D23/364
D961,751 S * 8/2022 Li D23/364

FIG. 1 is a front perspective view of an air purifier showing our new design;
FIG. 2 is a rear perspective view thereof;
FIG. 3 is a front elevation view thereof;
FIG. 4 is a rear elevation view thereof;
FIG. 5 is a left side elevation view thereof;
FIG. 6 is a right side elevation view thereof;
FIG. 7 is a top plan view thereof;
FIG. 8 is a bottom plan view thereof; and,
FIG. 9 is an enlarged view of portion 9 in FIG. 1.
The evenly spaced broken lines illustrate portions of the air purifier that form no part of the claimed design.

1 Claim, 9 Drawing Sheets

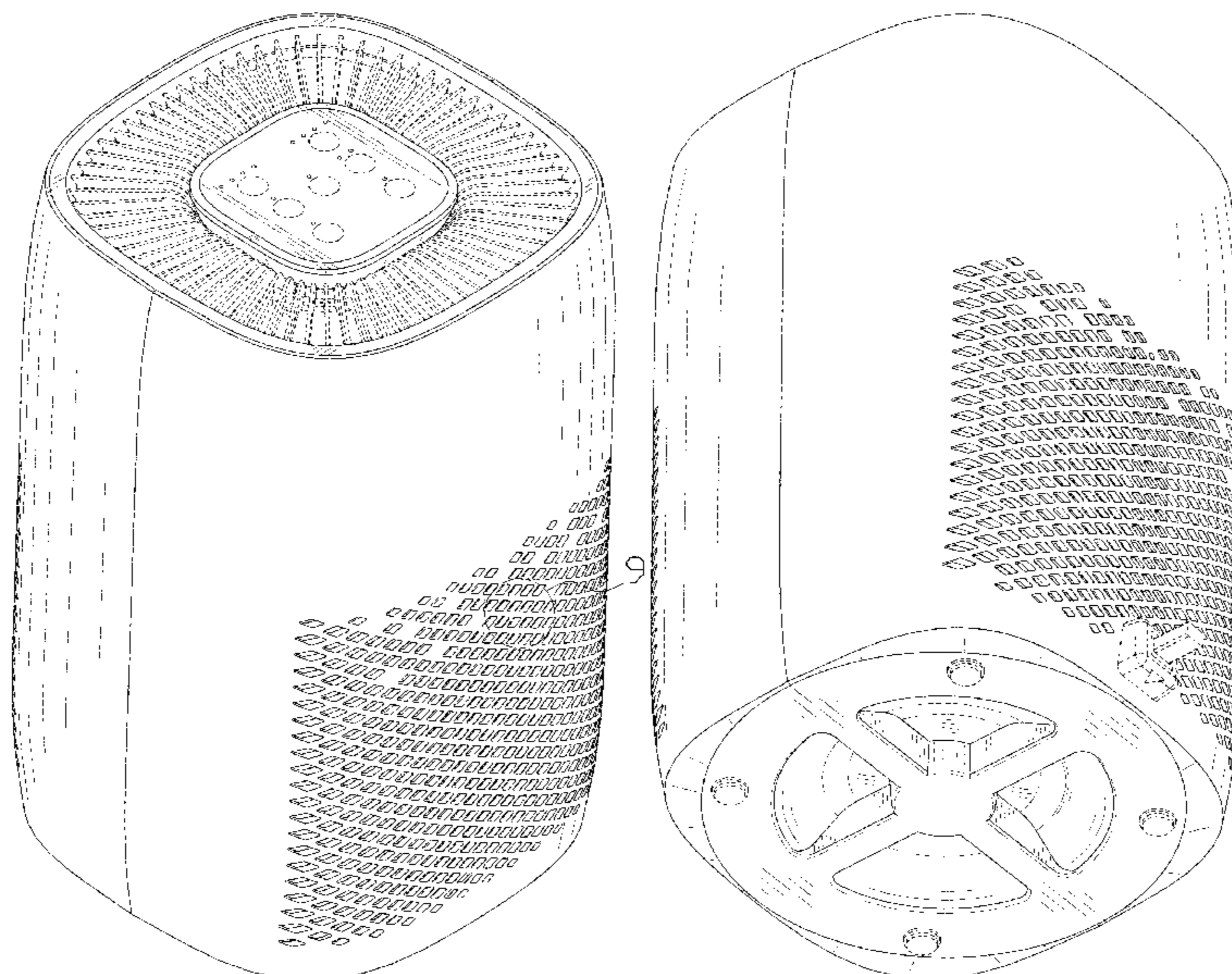

(56)

References Cited

OTHER PUBLICATIONS

Neiyidaren AP2000 Air Purifier. Catalogue [Online]. Amazon Standard ID# B0BKLL3DXB. Amazon.com 2022. [Date First Available {Oct. 26, 2022}][Retrieved on Jan. 31, 2023]. Retrieved from the Internet: <URL:https://www.amazon.com/Purifiers-Premium-Desktop-Purifier-Filtration/dp/B0BKLL3DXB> (Year: 2022).*

* cited by examiner

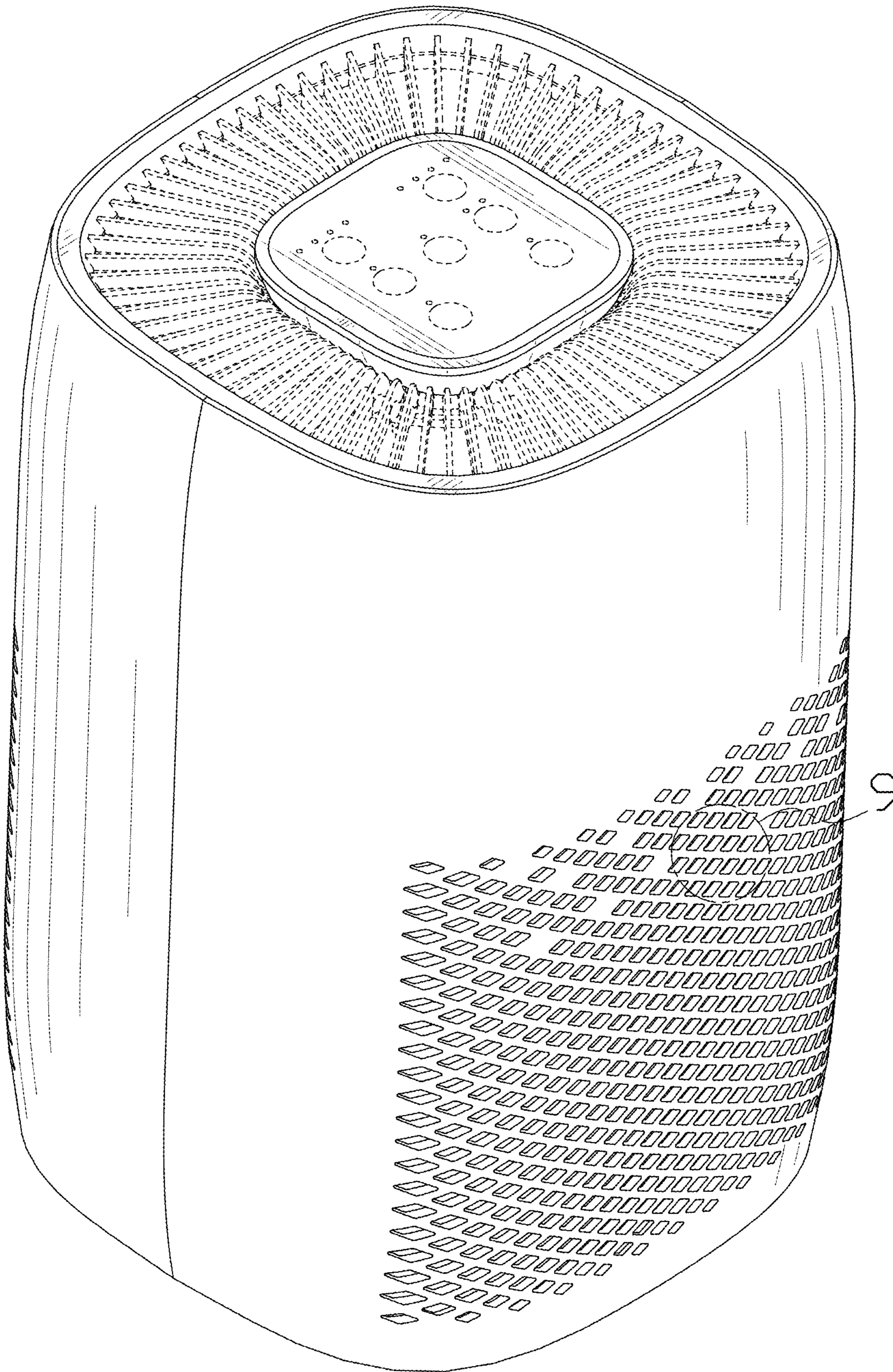

FIG. 1

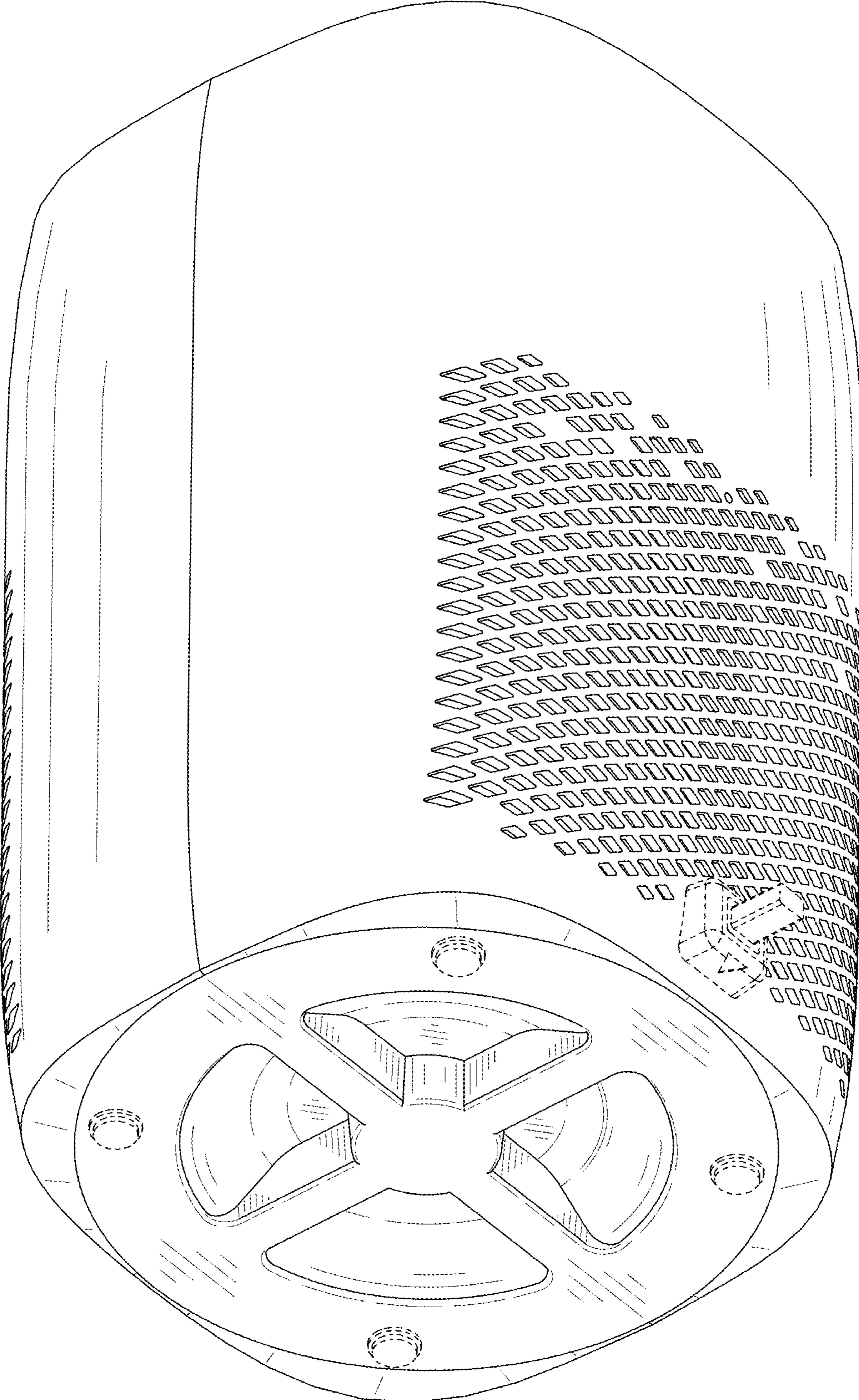

FIG. 2

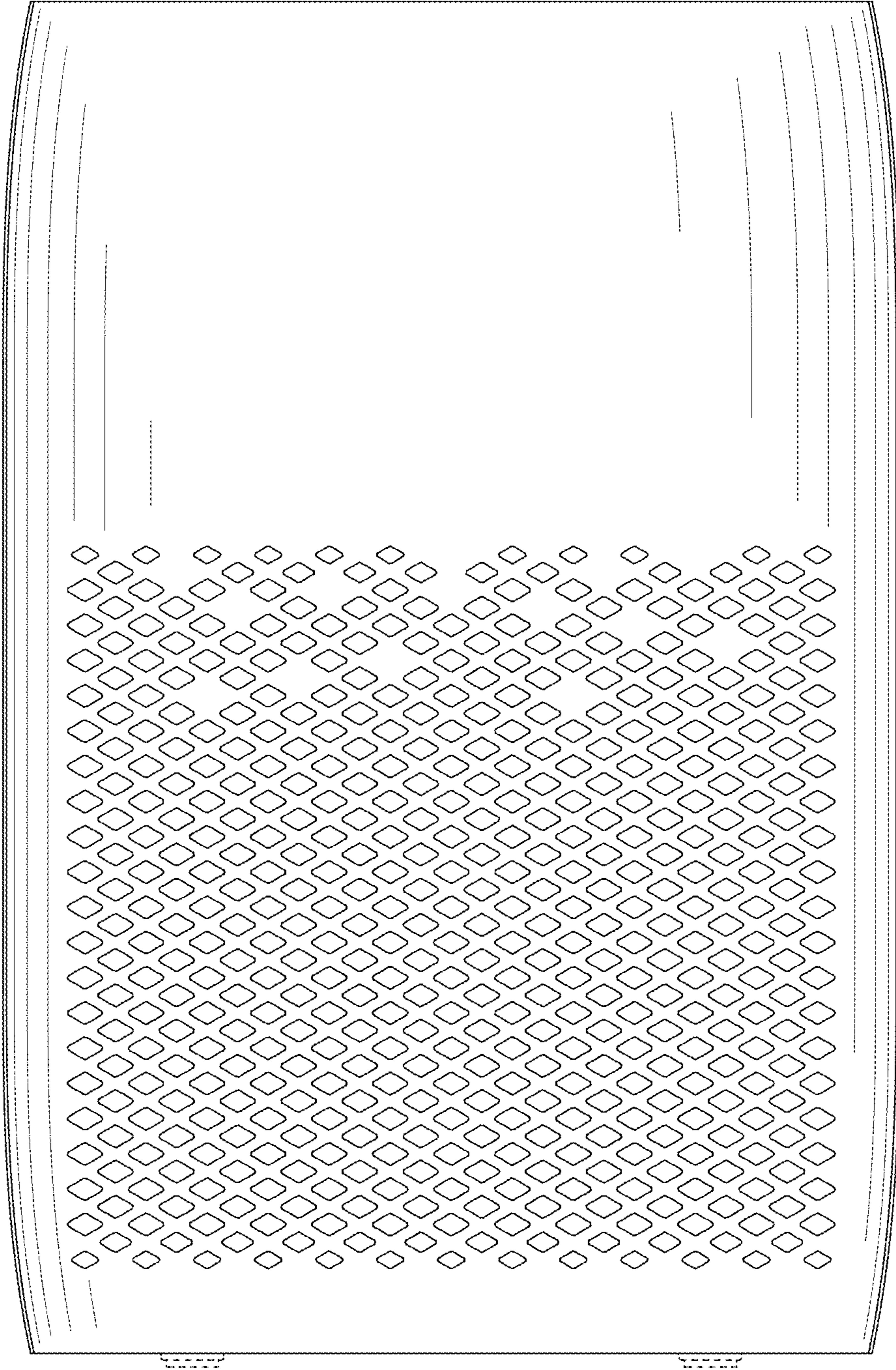

FIG. 3

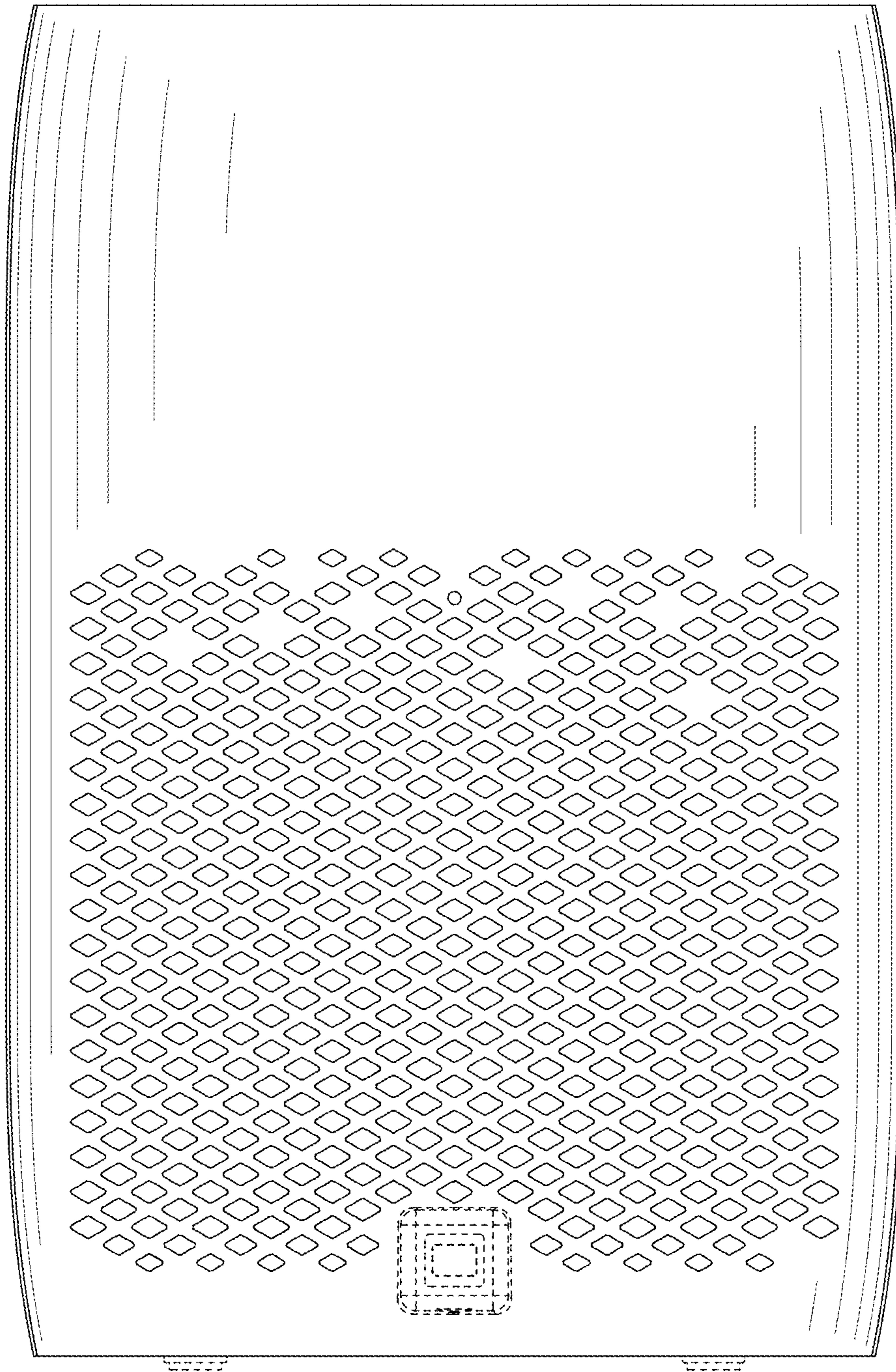

FIG. 4

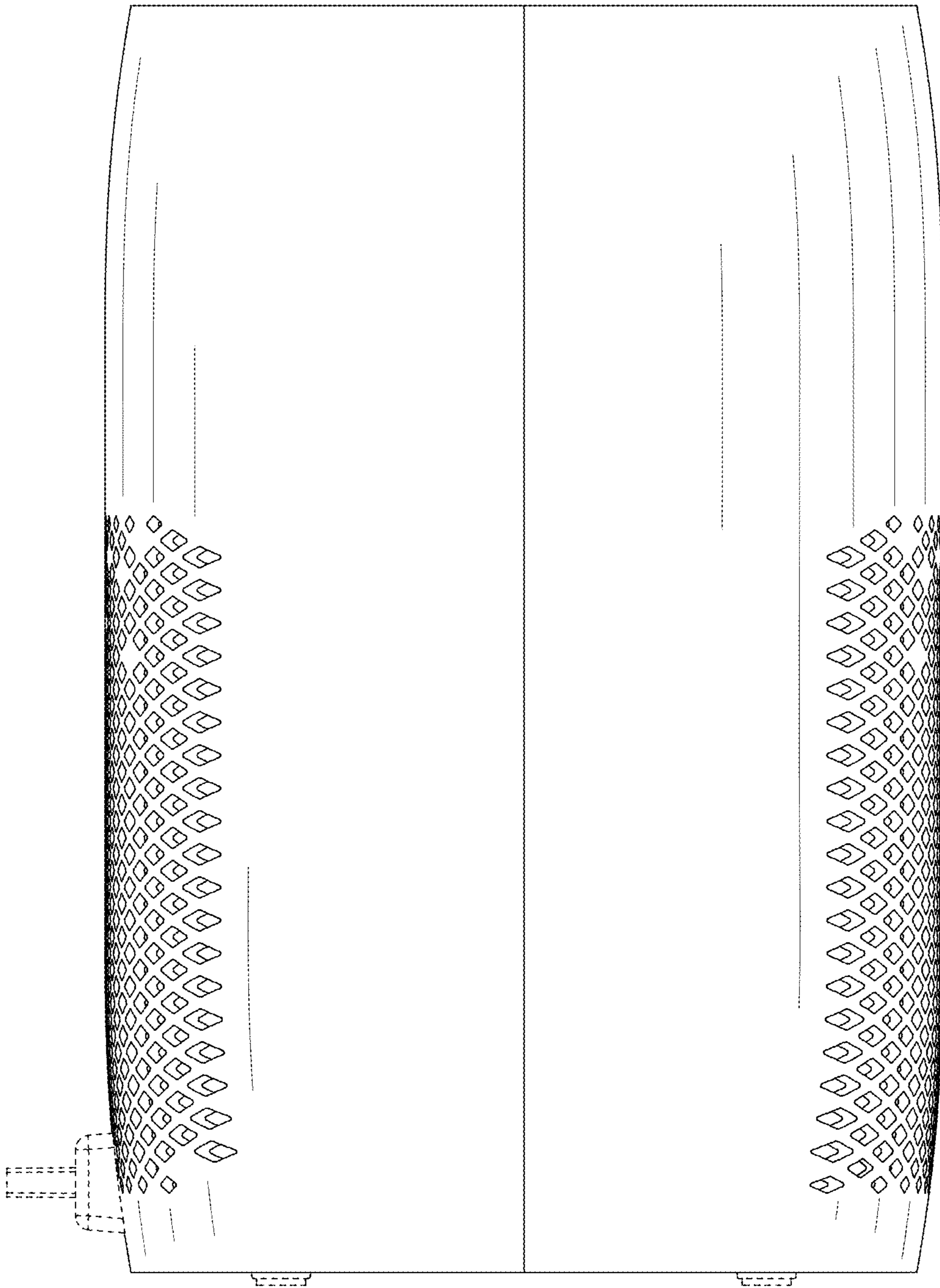

FIG. 5

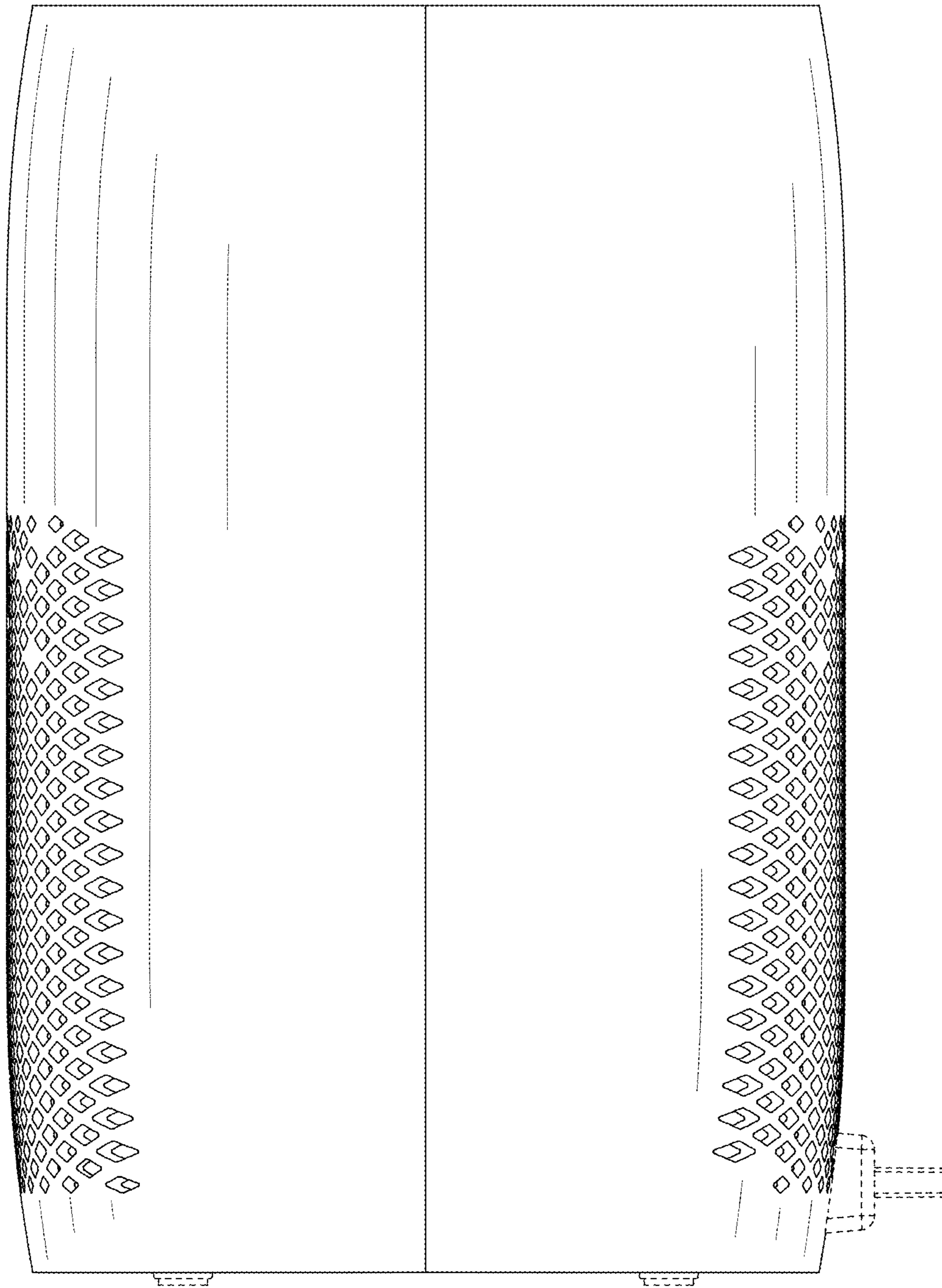

FIG. 6

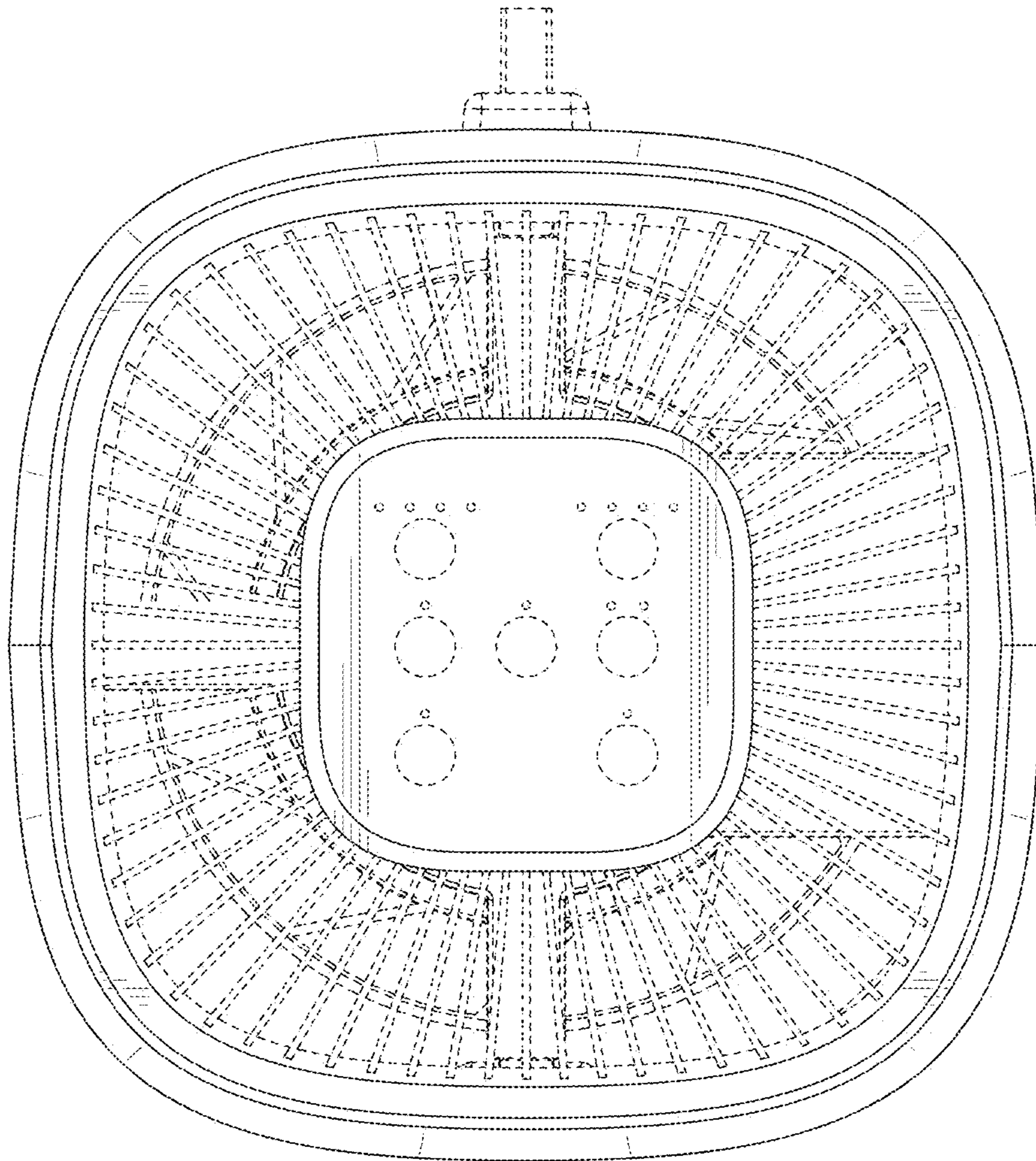

FIG. 7

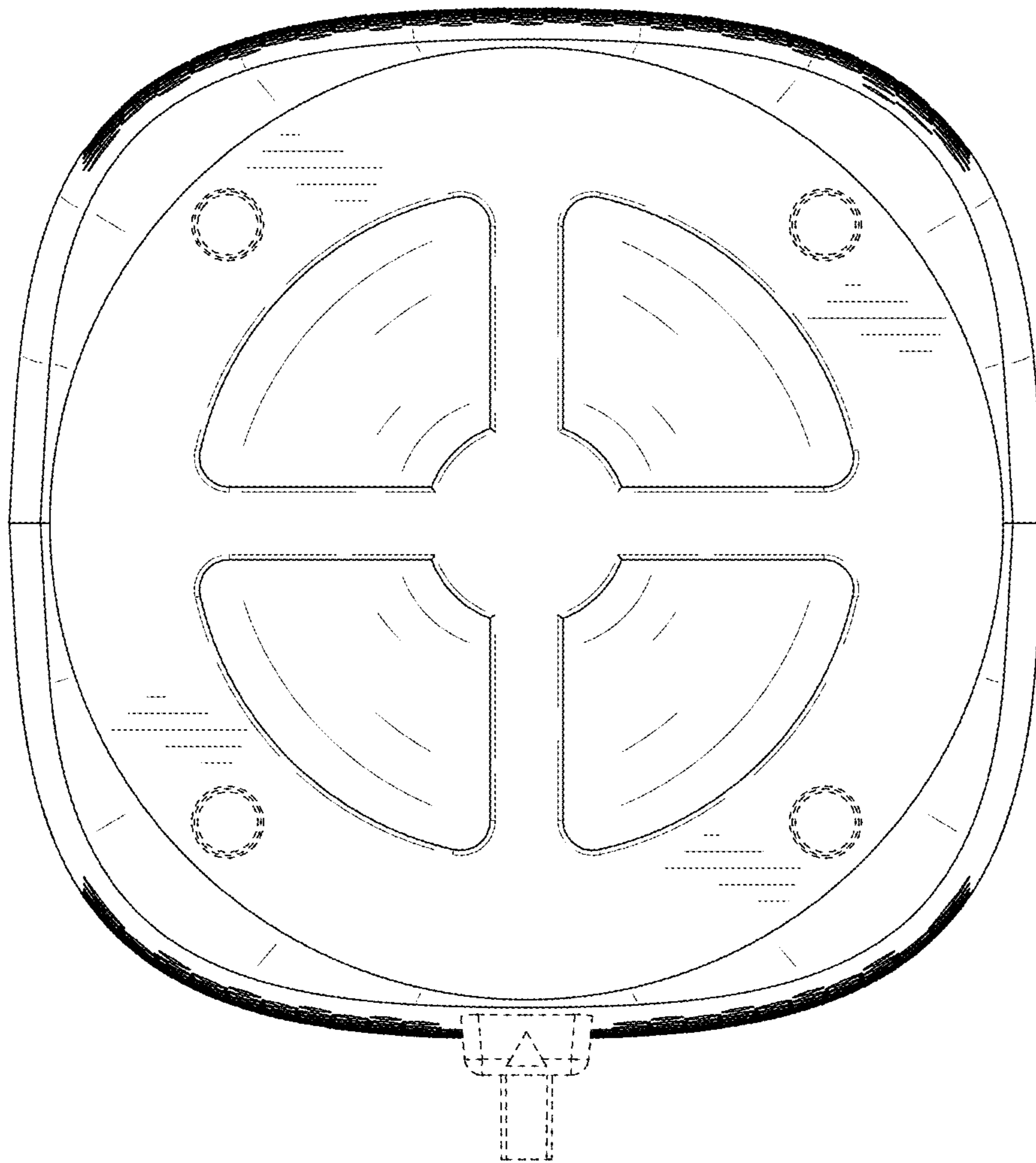

FIG. 8

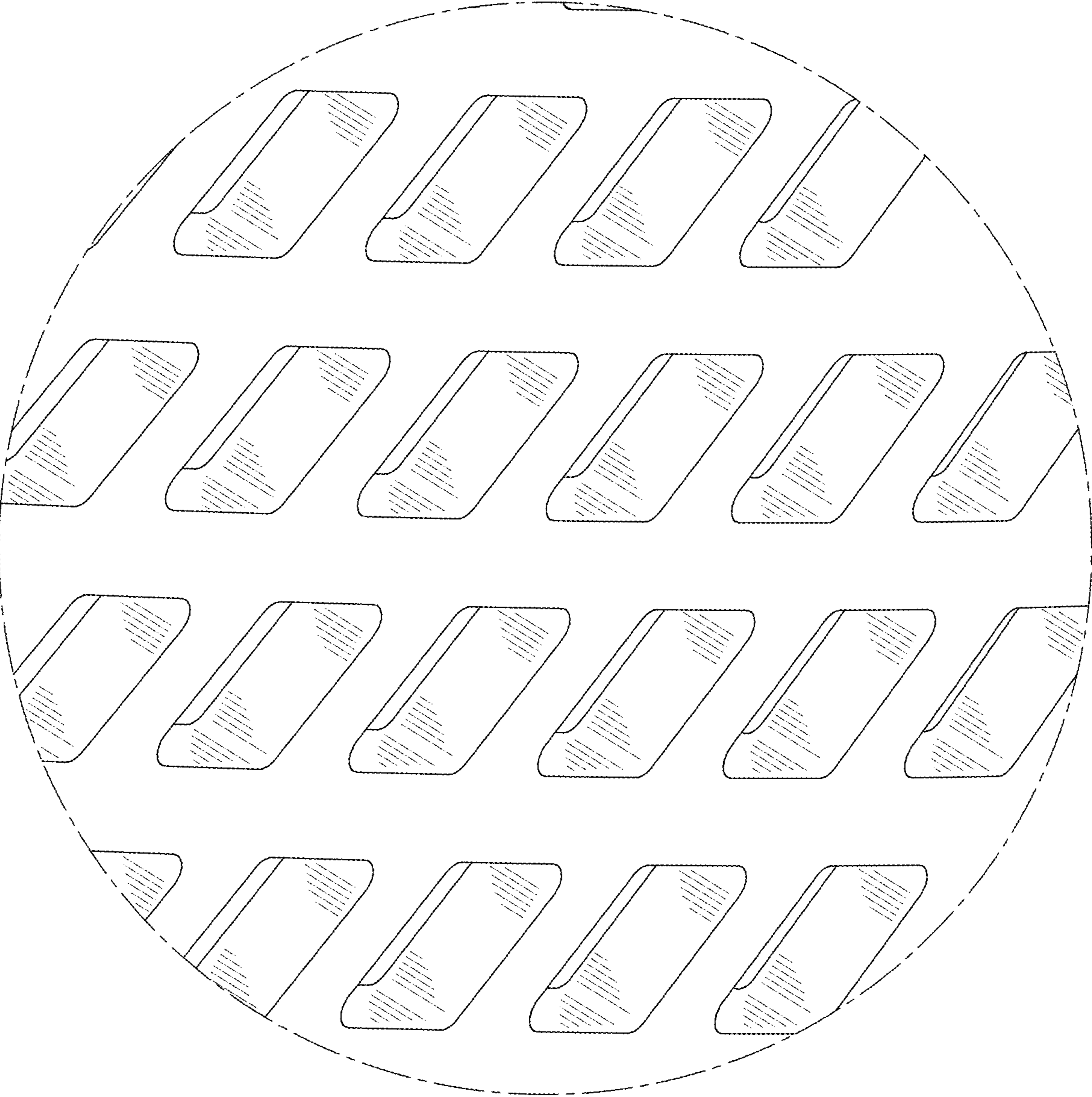

FIG. 9