



US00D987800S

(12) **United States Design Patent**  
**Chen et al.**

(10) **Patent No.:** **US D987,800 S**  
(45) **Date of Patent:** **\*\* May 30, 2023**

(54) **AIR PURIFIER**

(71) Applicant: **Healthlead Corporation Limited**,  
Shenzhen (CN)

(72) Inventors: **Yaogang Chen**, Shenzhen (CN);  
**Zhixue Zou**, Shenzhen (CN);  
**Hongzeng Zhang**, Shenzhen (CN)

(73) Assignee: **Healthlead Corporation Limited**,  
Shenzhen (CN)

(\*\*) Term: **15 Years**

(21) Appl. No.: **29/794,475**

(22) Filed: **Jun. 12, 2021**

(30) **Foreign Application Priority Data**

Feb. 2, 2021 (CN) ..... 202130076544.7

(51) **LOC (14) Cl.** ..... **23-04**

(52) **U.S. Cl.**  
USPC ..... **D23/364**

(58) **Field of Classification Search**  
USPC ..... D23/314, 332, 333, 335, 336, 355, 356,  
D23/364, 365, 366, 378  
CPC .... F24F 1/0022; F24F 3/14; F24F 6/06; F24F  
8/80; B01D 46/00281; B01D 46/0043;  
A61L 2209/12; A61L 2209/14  
See application file for complete search history.

(56) **References Cited**

**U.S. PATENT DOCUMENTS**

D705,410 S \* 5/2014 Terao ..... D23/364  
D799,016 S \* 10/2017 Su ..... D23/364  
D837,354 S \* 1/2019 Su ..... D23/364  
D898,889 S \* 10/2020 Yu ..... D23/364  
D912,796 S \* 3/2021 Huang ..... D23/364  
D918,367 S \* 5/2021 Li ..... D23/359  
D928,298 S \* 8/2021 Zuo ..... D23/364  
D934,837 S \* 11/2021 Huang ..... D14/214  
D942,602 S \* 2/2022 Yu ..... D23/356

D942,605 S \* 2/2022 Yu ..... D23/364  
D943,076 S \* 2/2022 Yu ..... D23/364  
D947,339 S \* 3/2022 Yu ..... D23/364  
D947,342 S \* 3/2022 Xu ..... D23/364

(Continued)

**FOREIGN PATENT DOCUMENTS**

CN 202230404595.2 \* 10/2022

**OTHER PUBLICATIONS**

FIWOTTTDA Breathe Nature 01. Catalogue [Online]. Amazon Standard ID# B09PHCC8CG. Amazon.com 2022. [Date First Available {Jan. 4, 2022}][Retrieved on Jan. 11, 2023]. Retrieved from the Internet: <URL:https://www.amazon.com/FIWOTTTDA-Purifiers-Coverage-Quality-Monitor/dp/B09PHCC8CG> (Year: 2022).\*

(Continued)

*Primary Examiner* — Janice Hallmark

*Assistant Examiner* — Adedoyin Taiwo Odeyale

(74) *Attorney, Agent, or Firm* — Westbridge IP LLC

(57) **CLAIM**

The ornamental design for an air purifier, as shown and described.

**DESCRIPTION**

FIG. 1 is a front perspective view of an air purifier showing our new design;  
FIG. 2 is a rear perspective view thereof;  
FIG. 3 is a front elevation view thereof;  
FIG. 4 is a rear elevation view thereof;  
FIG. 5 is a left side elevation view thereof;  
FIG. 6 is a right side elevation view thereof;  
FIG. 7 is a top plan view thereof;  
FIG. 8 is a bottom plan view thereof; and,  
FIG. 9 is an enlarged view of portion 9 in FIG. 1.  
The evenly spaced broken lines illustrate portions of the air purifier that form no part of the claimed design.

**1 Claim, 9 Drawing Sheets**

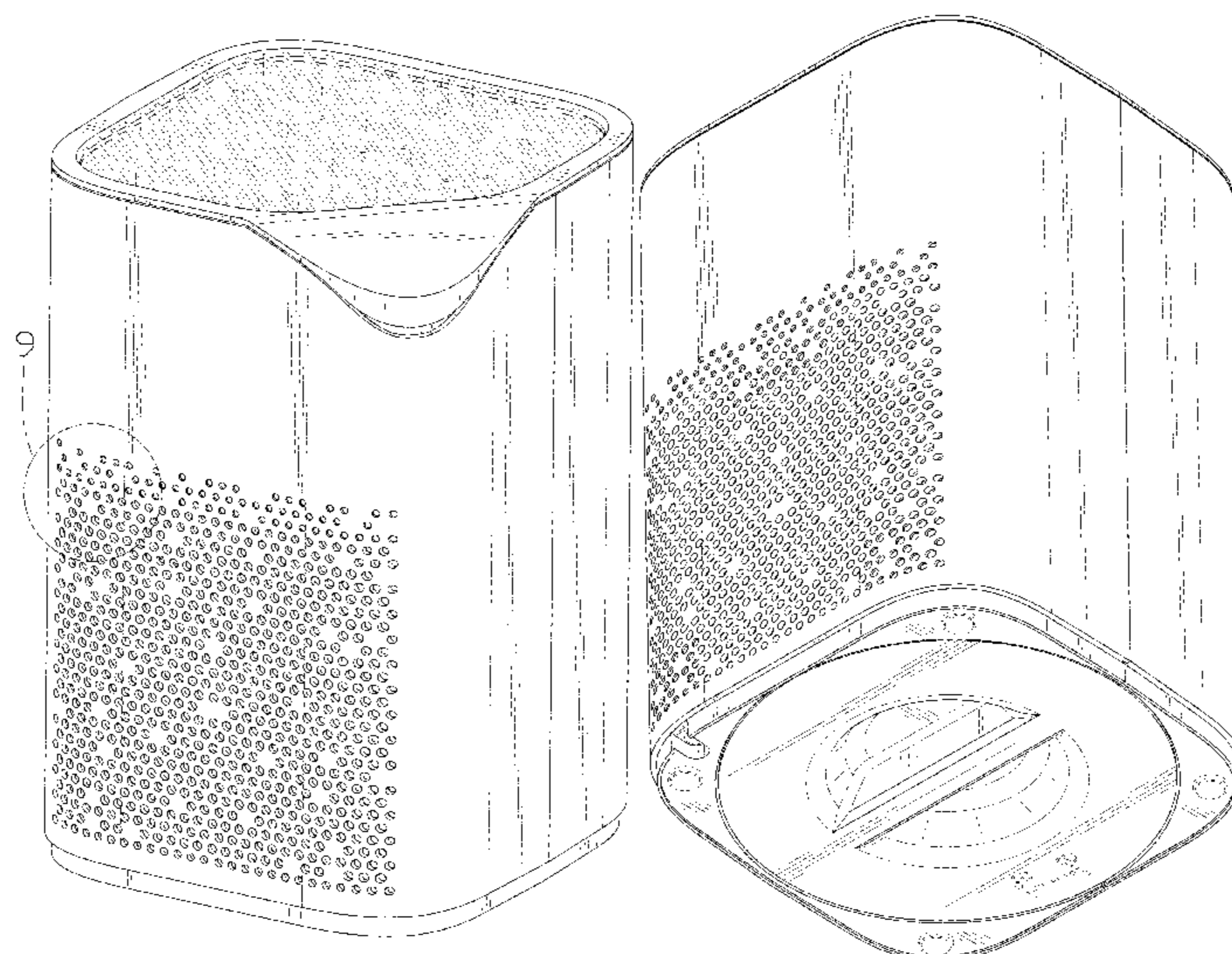

(56)

**References Cited**

U.S. PATENT DOCUMENTS

D948,017 S \* 4/2022 Chen ..... D23/364  
D952,814 S \* 5/2022 Tang ..... D23/356  
D964,534 S \* 9/2022 Yu ..... D23/364  
D970,706 S \* 11/2022 Chen ..... D23/364

OTHER PUBLICATIONS

Healthlead EPI151 Air Purifier. Product datasheet [Online].  
Healthleadairpurifier.com 2021. [Retrieved on Jan. 11, 2023]. Retrieved  
from the Internet: <URL:https://www.healthleadairpurifier.com/sale-  
32928989-desktop-smart-99-97-hepa-air-purifier-for-household-pet-  
family-bedroom.html> (Year: 2023).\*

\* cited by examiner

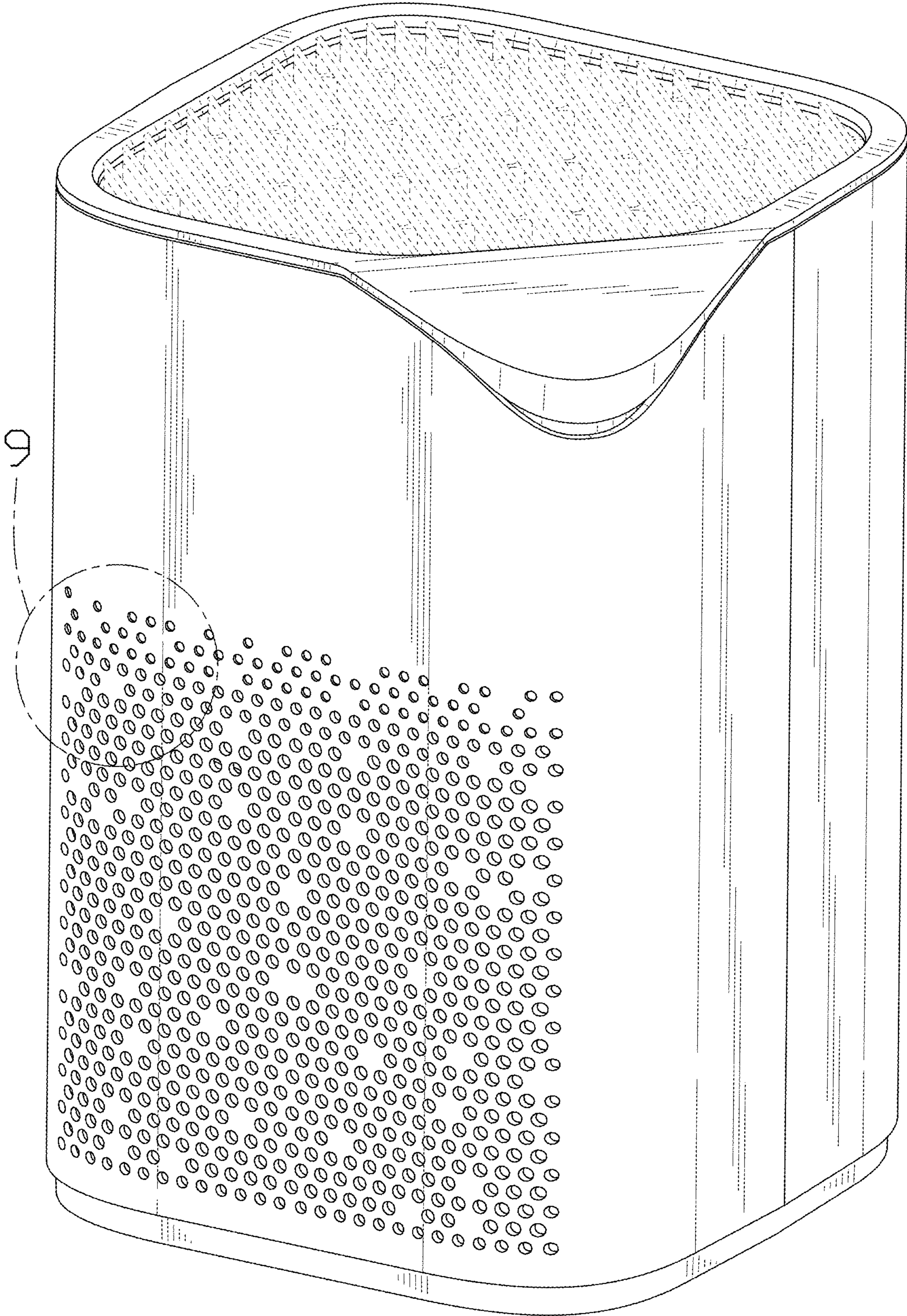

FIG. 1

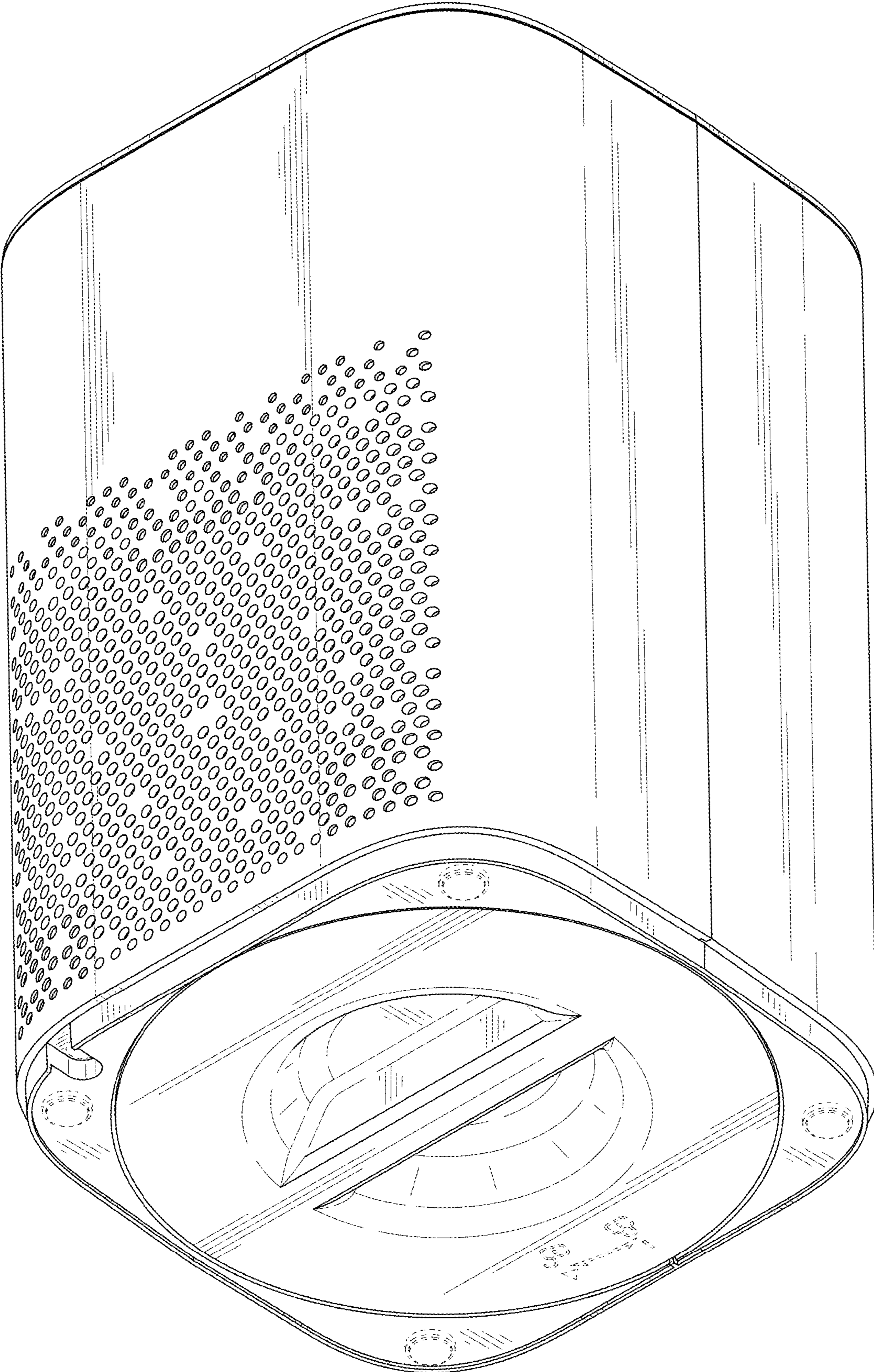

FIG. 2

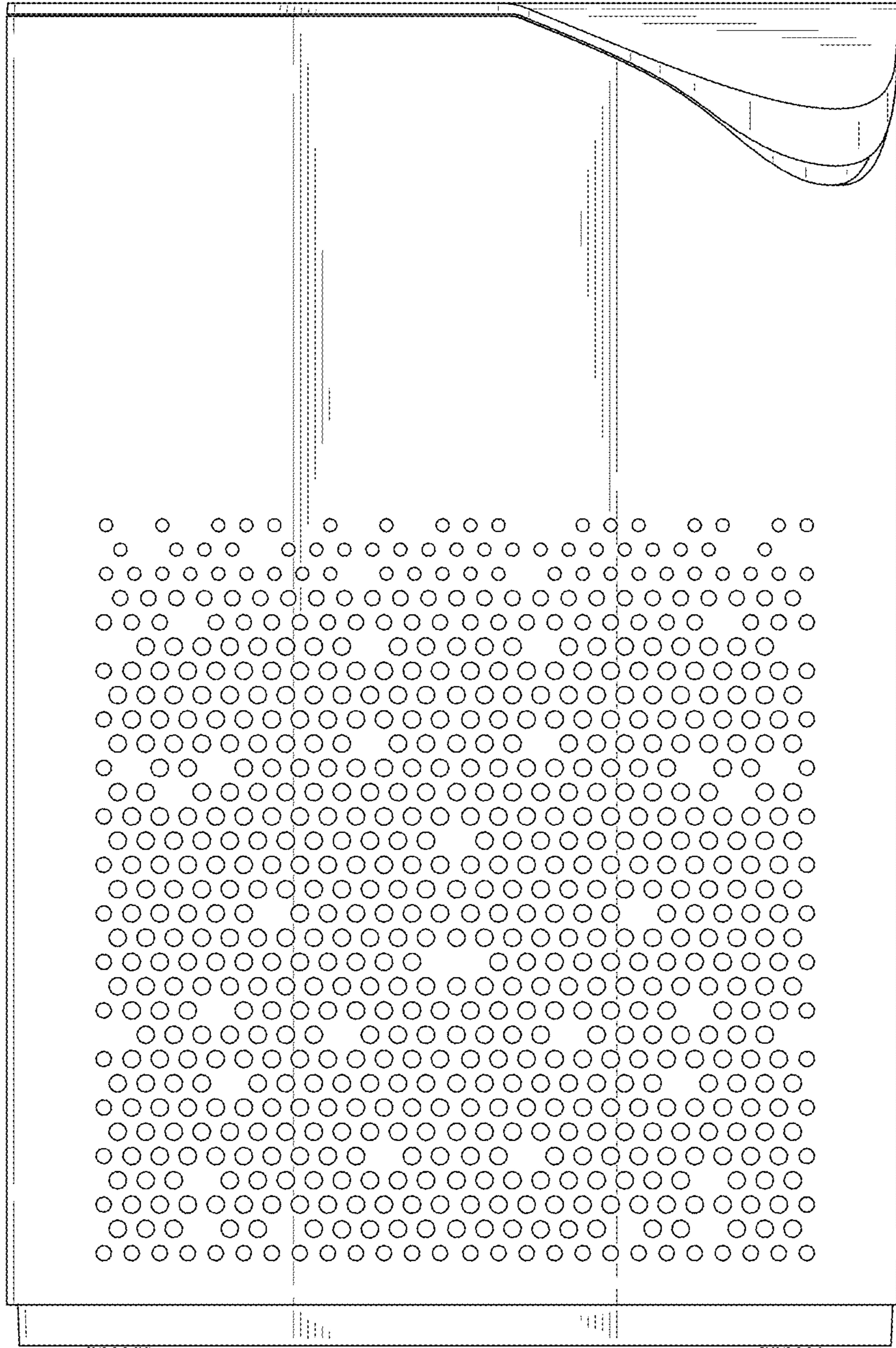

FIG. 3

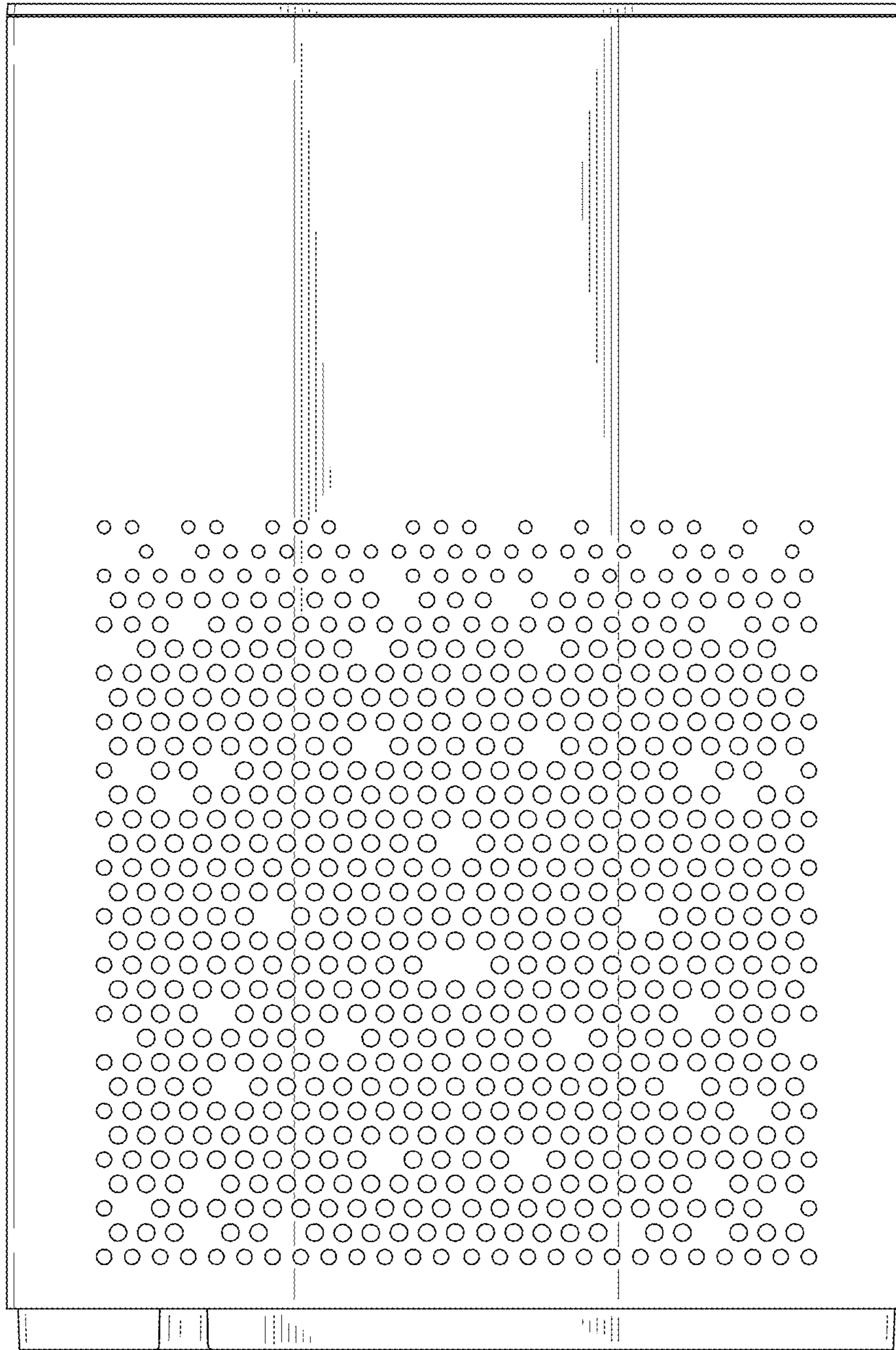

FIG. 4

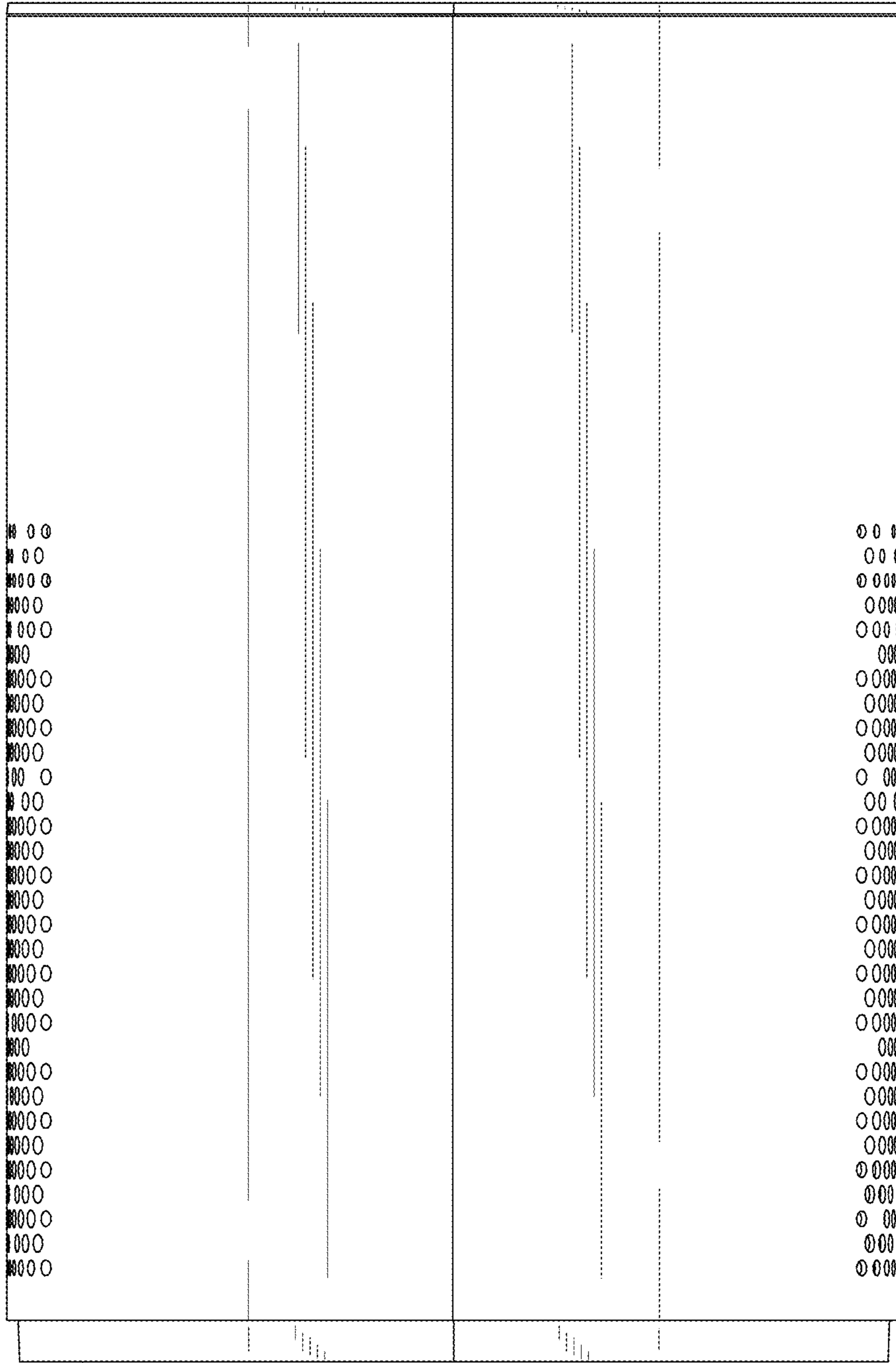

FIG. 5

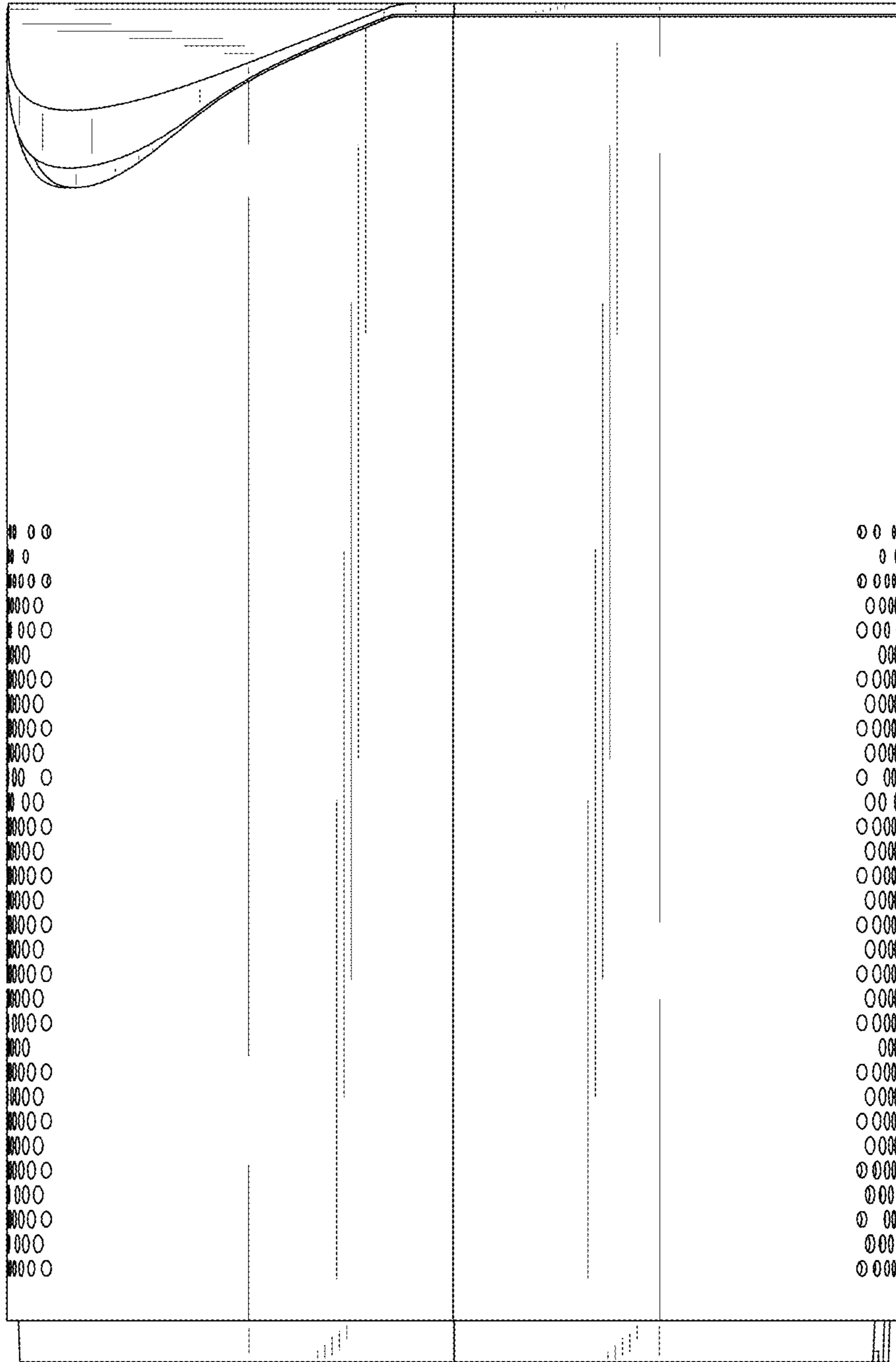

FIG. 6



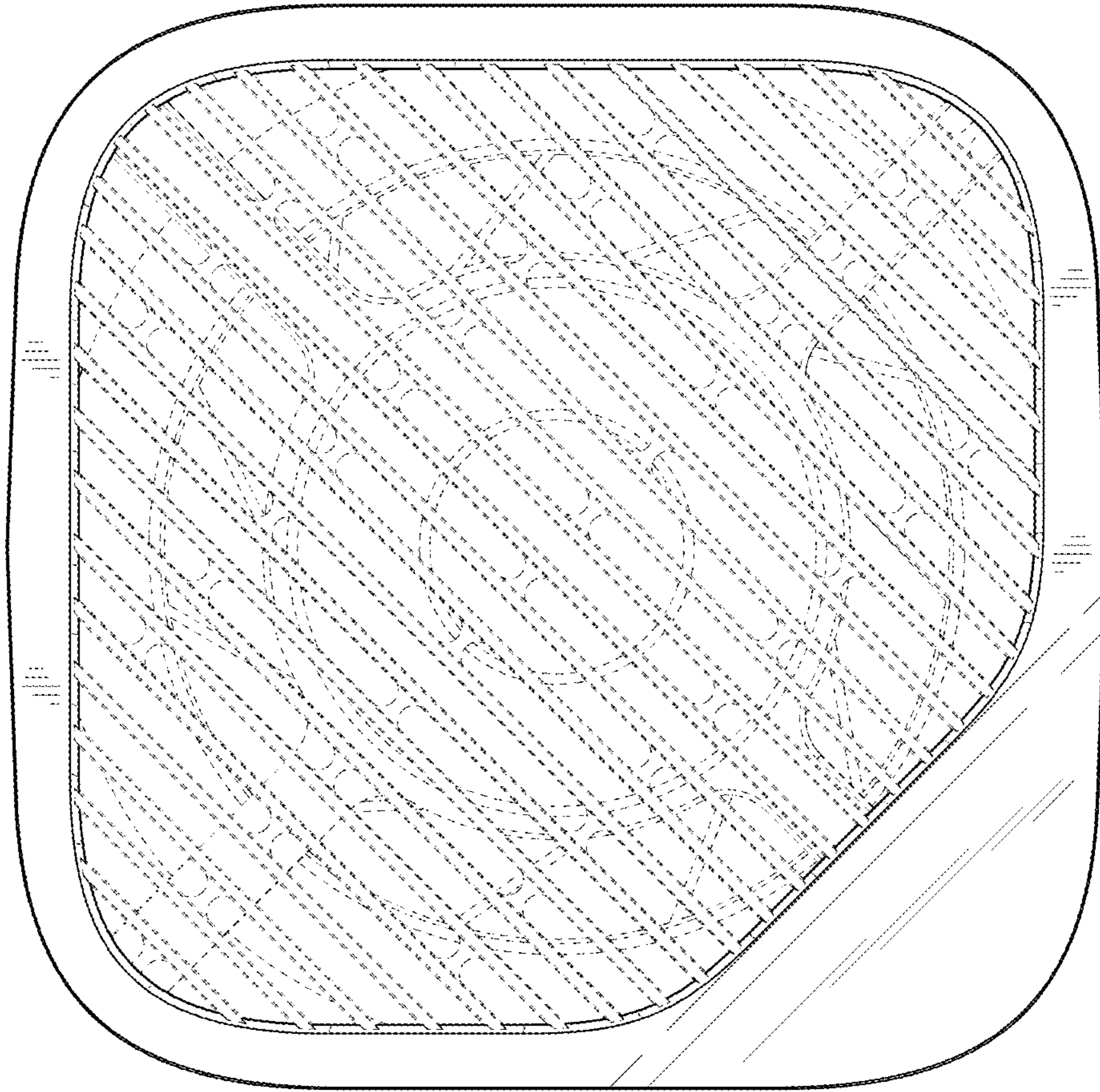

FIG. 7

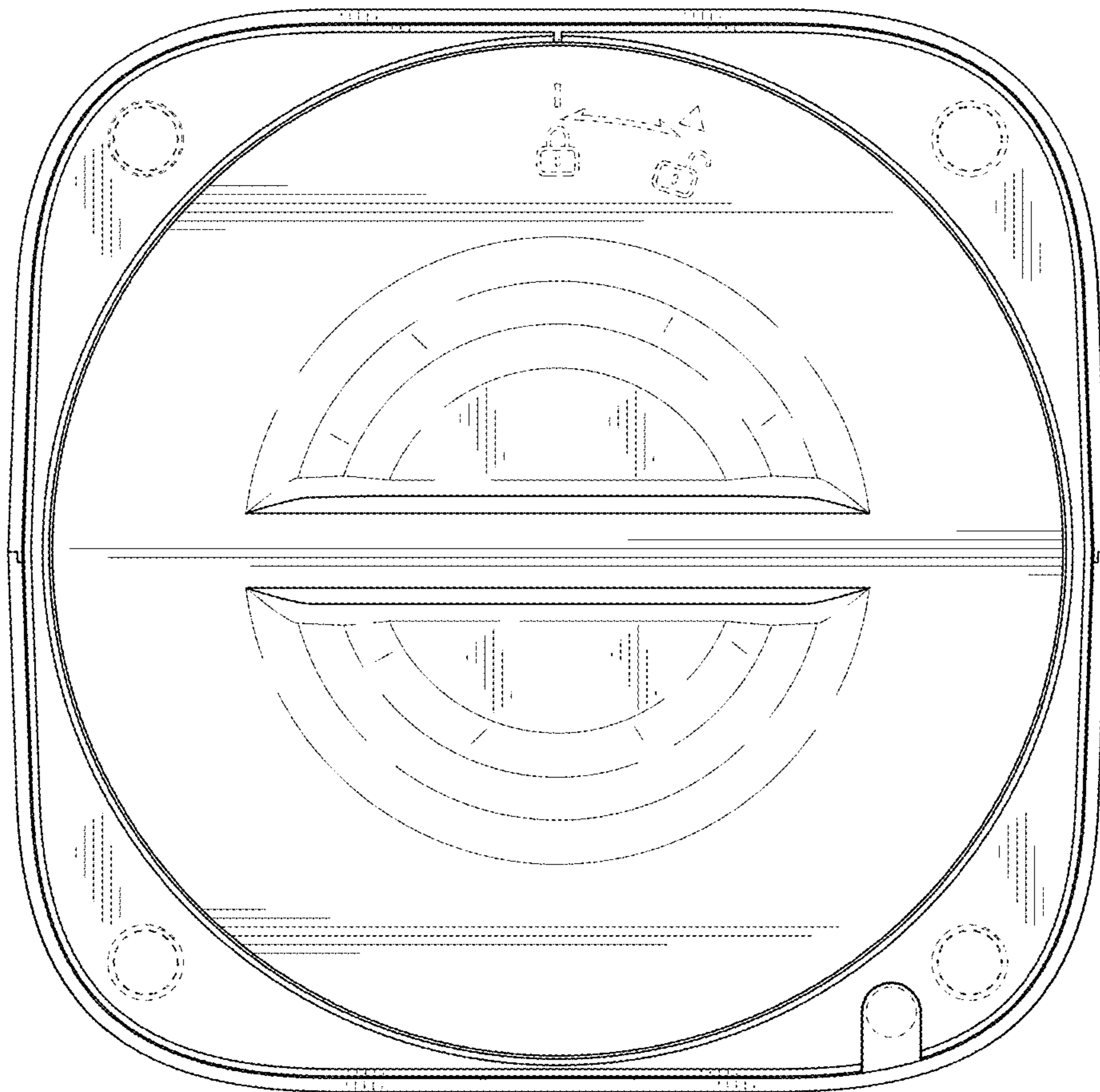

FIG. 8

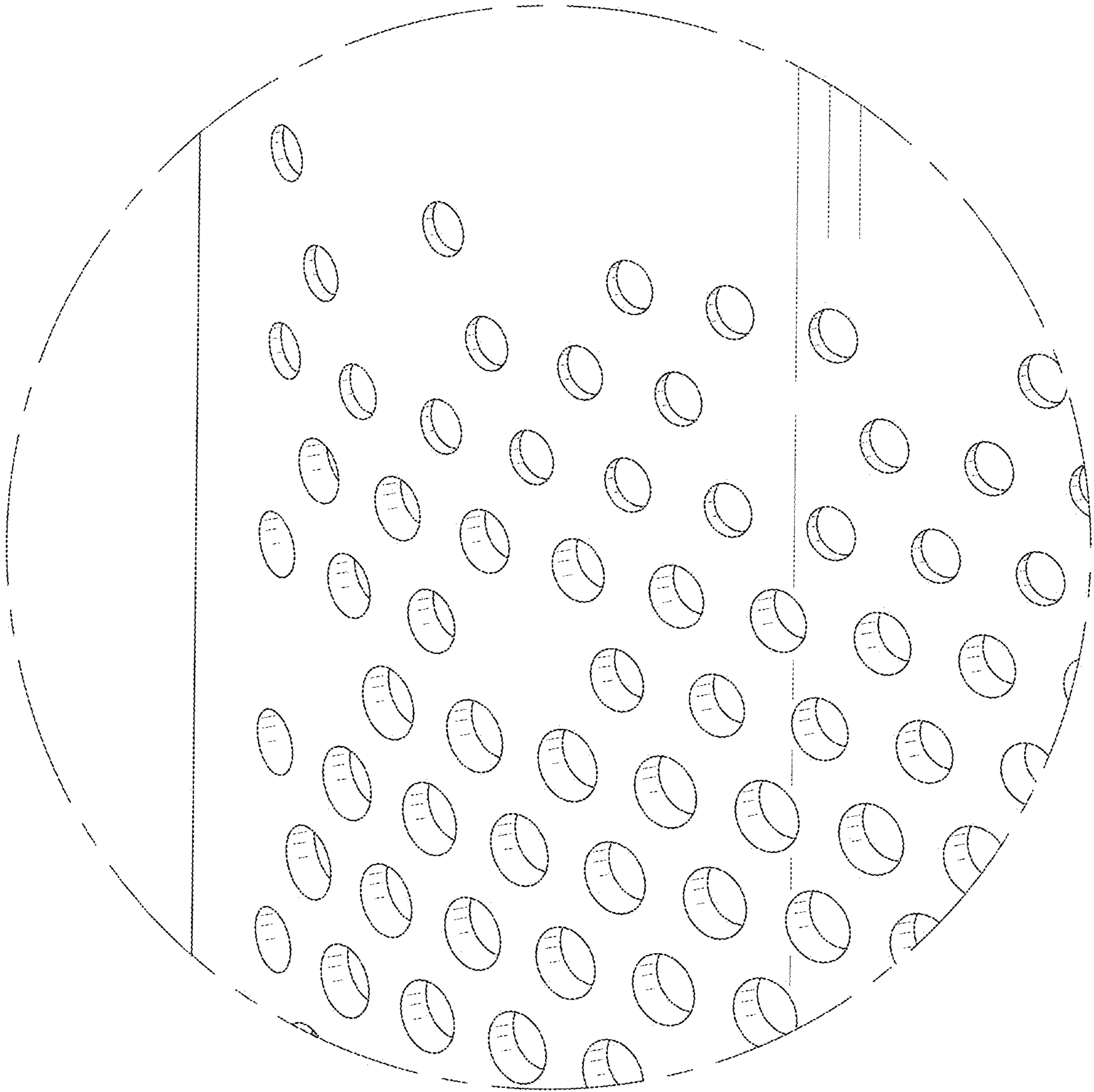

FIG. 9