



US00D987719S

(12) **United States Design Patent**
Chang Chien

(10) **Patent No.:** **US D987,719 S**

(45) **Date of Patent:** **** *May 30, 2023**

(54) **STACKABLE RACK**

(71) Applicant: **EP Family Corp.**, Walnut, CA (US)

(72) Inventor: **Peiling Chang Chien**, Walnut, CA (US)

(*) Notice: This patent is subject to a terminal disclaimer.

(**) Term: **15 Years**

(21) Appl. No.: **29/772,680**

(22) Filed: **Mar. 3, 2021**

(51) **LOC (14) Cl.** **19-02**

(52) **U.S. Cl.**
USPC **D19/92**

(58) **Field of Classification Search**

USPC D19/92, 75-91, 99, 135; D3/206, 304,
D3/306, 310, 315; D6/675.5, 683, 683.1;
D7/631, 637-641; D9/427, 432, 611;
D14/253

CPC .. B43M 99/00; B43M 99/001; B43M 99/003;
B43M 99/006; B43M 99/007; B43M
99/008; B43M 99/009; B42D 3/12; B42D
3/16; B42D 3/18; B43K 23/001; B43K
23/002; A47B 55/00; A47B 63/00

See application file for complete search history.

(56) **References Cited**

U.S. PATENT DOCUMENTS

D33,268 S * 9/1900 Rix 49/46
D33,269 S * 9/1900 Rix D19/92
D235,994 S * 7/1975 Stiene D19/92

(Continued)

FOREIGN PATENT DOCUMENTS

CN 306303537 * 9/2020
CN 306123802 * 10/2020

(Continued)

OTHER PUBLICATIONS

Modular Stacking Storage Basket posted by IRIS USA posted date unknown, © Amazon, [online], [site visited Aug. 22, 2022]. Available from Internet, <https://www.amazon.com/IRIS-Modular-Stacking-Storage-Basket/dp/B076J3CK6V?th=1#customerReviews> (Year: 2022).*

(Continued)

Primary Examiner — Garth Rademaker

Assistant Examiner — Laura H Yu

(74) *Attorney, Agent, or Firm* — Tommy S F Wang;
Wang IP Law Group, P.C.

(57) **CLAIM**

The ornamental design for a stackable rack, as shown and described.

DESCRIPTION

FIG. 1 is a perspective view of a stackable rack showing my new design;

FIG. 2 is a front view thereof;

FIG. 3 is a rear view thereof;

FIG. 4 is a left side view thereof;

FIG. 5 is a right side view thereof;

FIG. 6 is a top view thereof;

FIG. 7 is a bottom view thereof;

FIG. 8 is an enlarged view of an indicated portion of FIG. 1;

FIG. 9 is an enlarged view of an indicated portion of FIG. 4; and,

FIG. 10 is an enlarged view of an indicated portion of FIG. 6.

The dash-dash broken lines in FIGS. 1-10 illustrate portions of the stackable rack that form no part of the claimed design. The dot-dash broken lines in FIGS. 1, 4, and 6 indicate enlargement regions and the dot-dash broken lines in FIGS. 8-10 illustrate the boundaries of the figures.

1 Claim, 10 Drawing Sheets

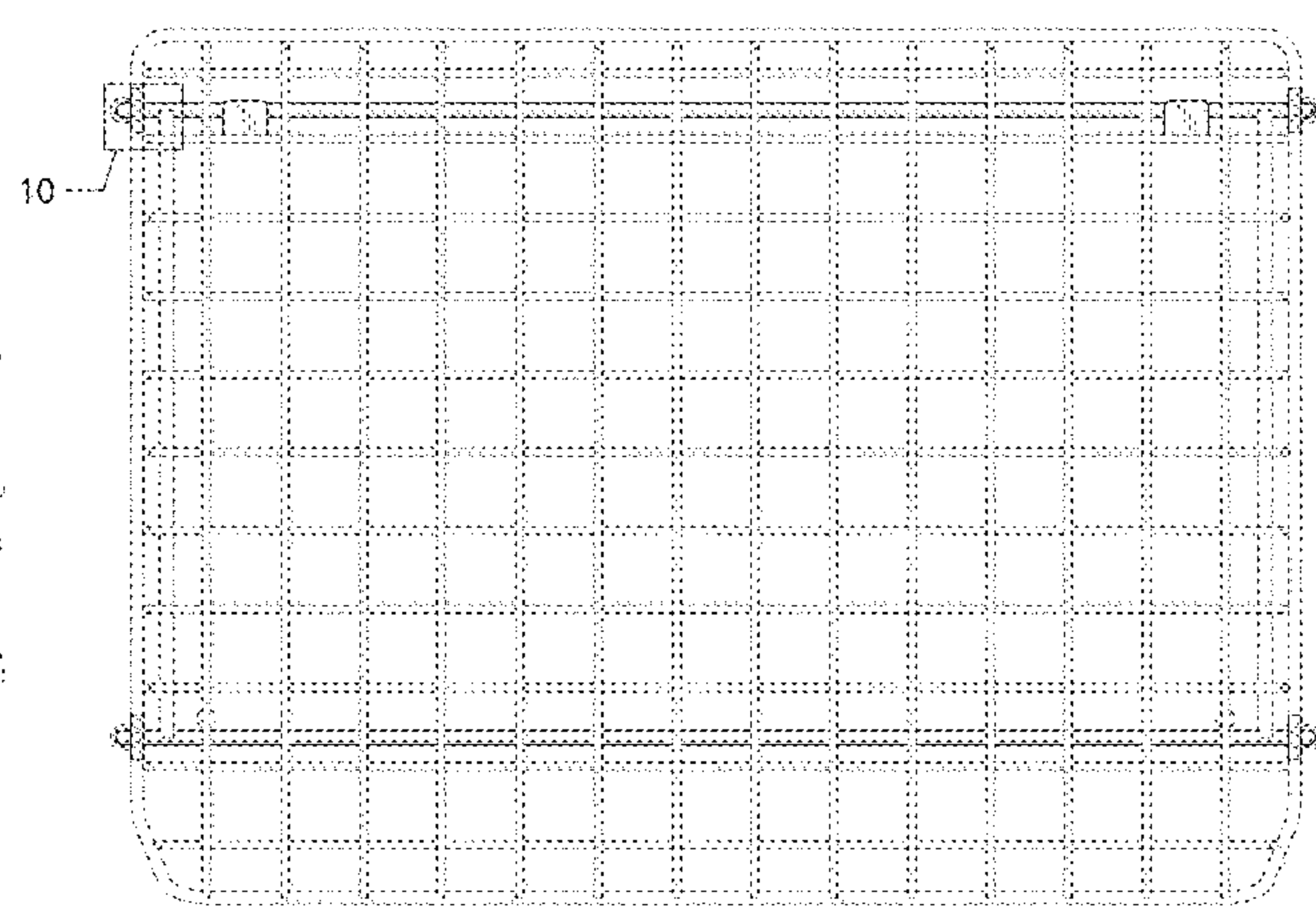
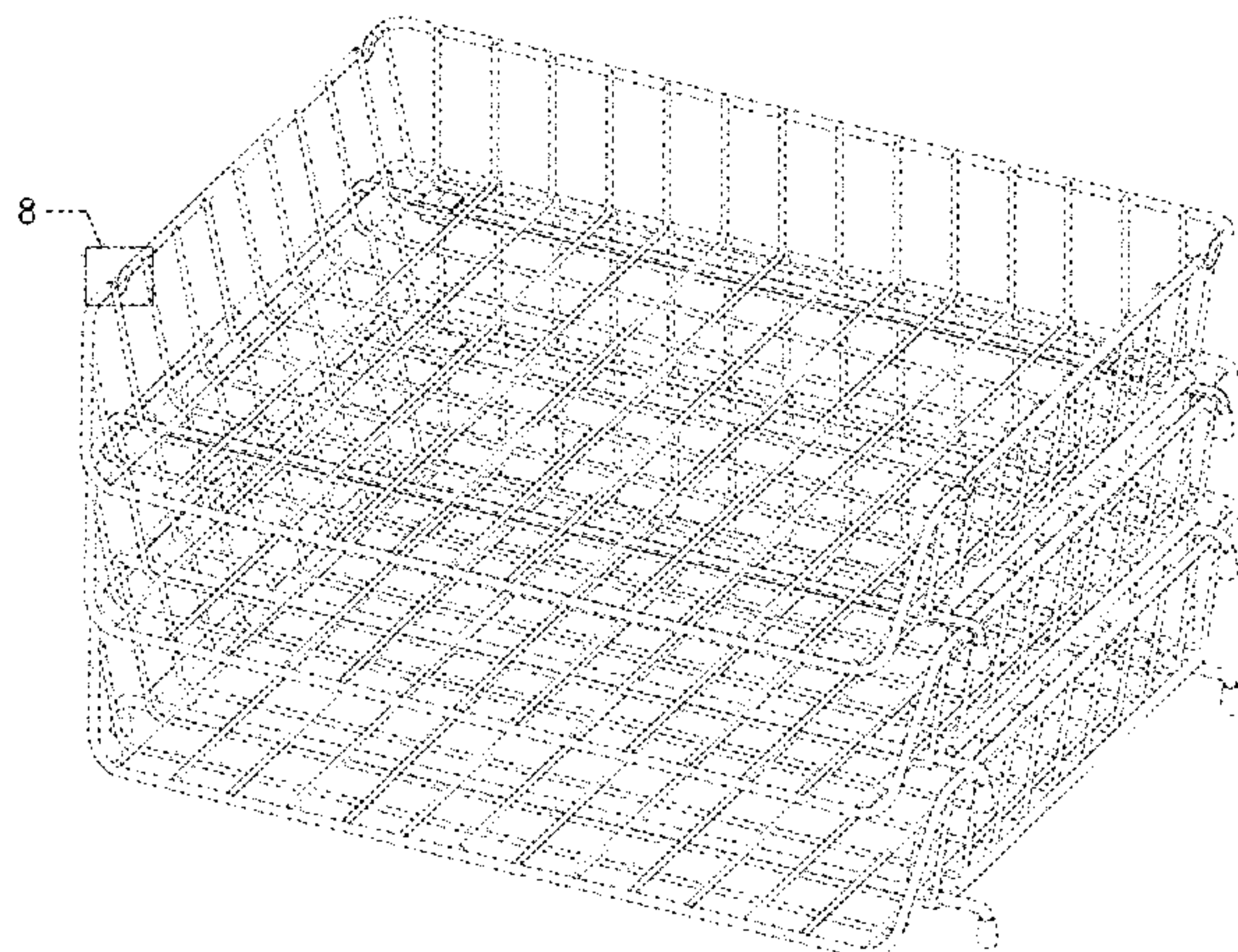

(56)

References Cited

U.S. PATENT DOCUMENTS

3,915,097 A * 10/1975 Young, Jr. A47F 5/12
 211/187
 4,943,029 A * 7/1990 Szuster A47F 5/13
 211/181.1
 D699,986 S * 2/2014 Tsai D6/675.4
 8,739,986 B2 * 6/2014 Preidt A47F 5/00
 211/188
 9,004,300 B1 * 4/2015 Morrell A47B 96/024
 248/242
 9,247,834 B1 * 2/2016 Lucht A47F 5/0018
 10,051,979 B2 * 8/2018 Kuo A47B 73/006
 10,842,263 B1 * 11/2020 Chen A47B 45/00
 D908,358 S * 1/2021 Zhai D3/306
 10,959,516 B2 * 3/2021 Cheng A47B 47/024
 D924,327 S * 7/2021 Tsai D19/92
 D928,874 S * 8/2021 Hu D19/92
 D935,524 S * 11/2021 Liu D19/90
 D935,776 S * 11/2021 Li D3/306

FOREIGN PATENT DOCUMENTS

CN 306306123 * 2/2021
 GB 6114606 * 1/2021

OTHER PUBLICATIONS

Rose Gold Tier Stackable Paper Tray Desk Organizer posted by Jolitac Store posted date Jun. 16, 2020, © Amazon, [online], [site visited Aug. 22, 2022]. Available from Internet, <https://www.amazon.com/dp/B08B86SWQ4/> (Year: 2020).*

* cited by examiner

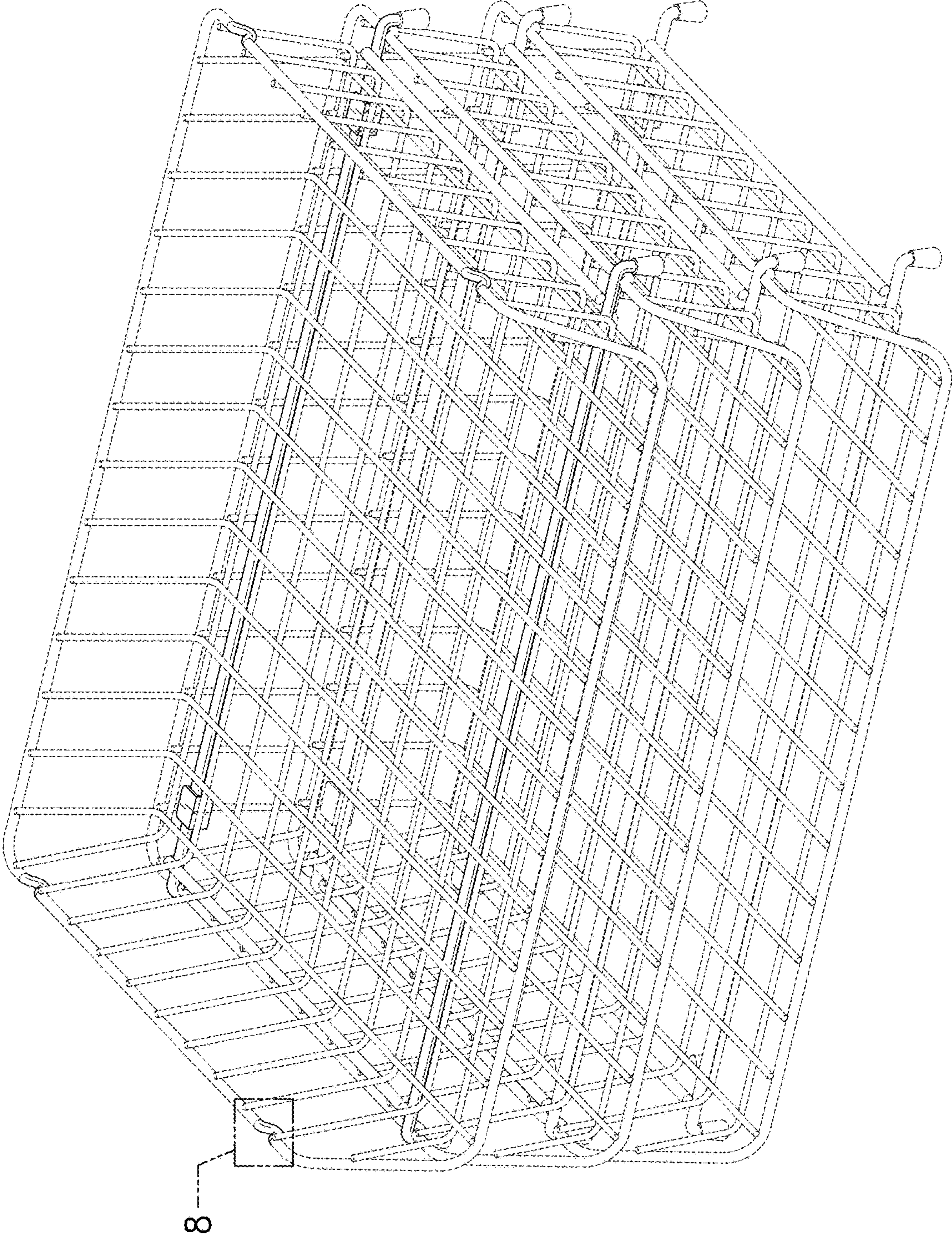

FIG. 1

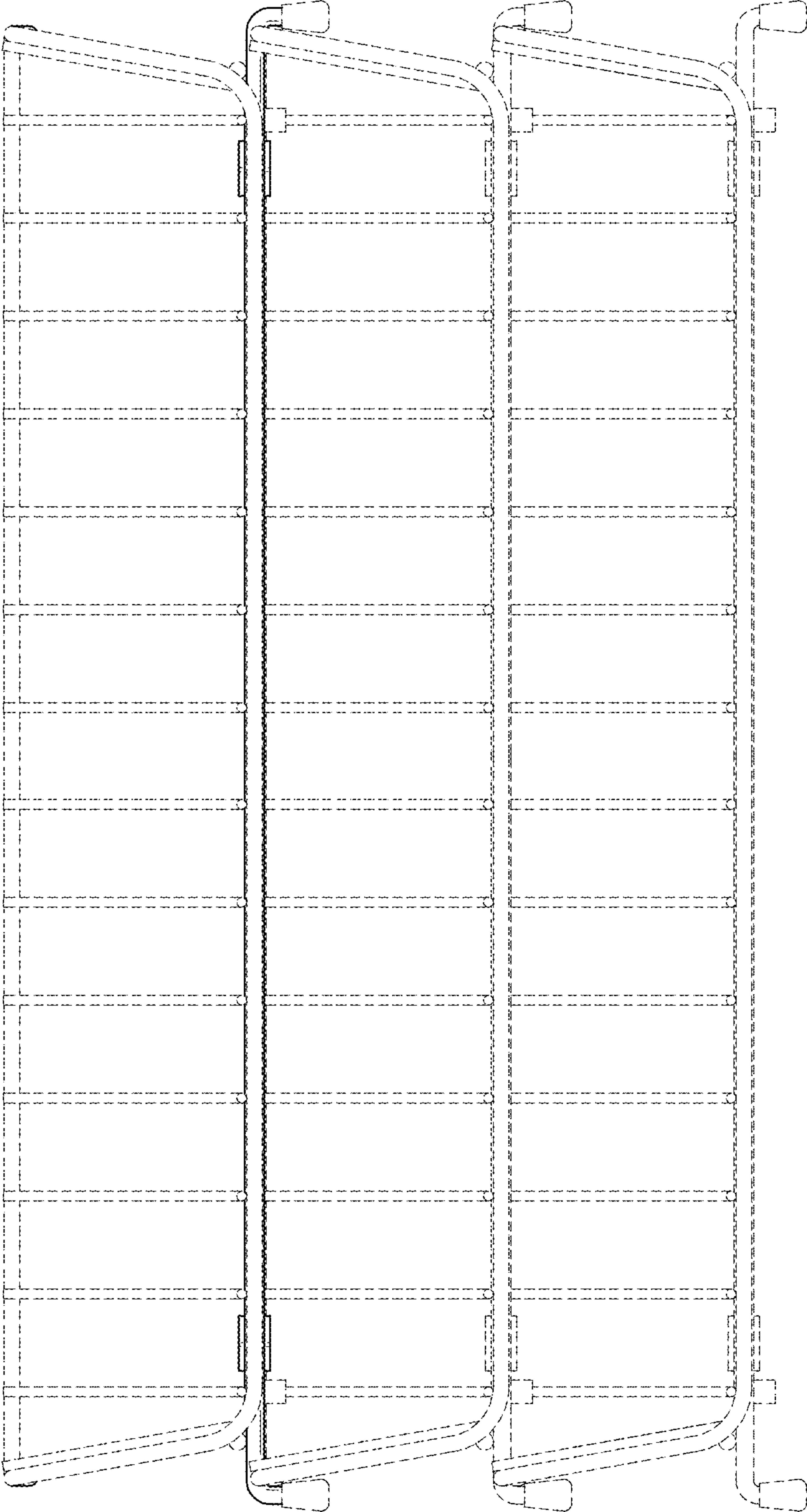

FIG. 2

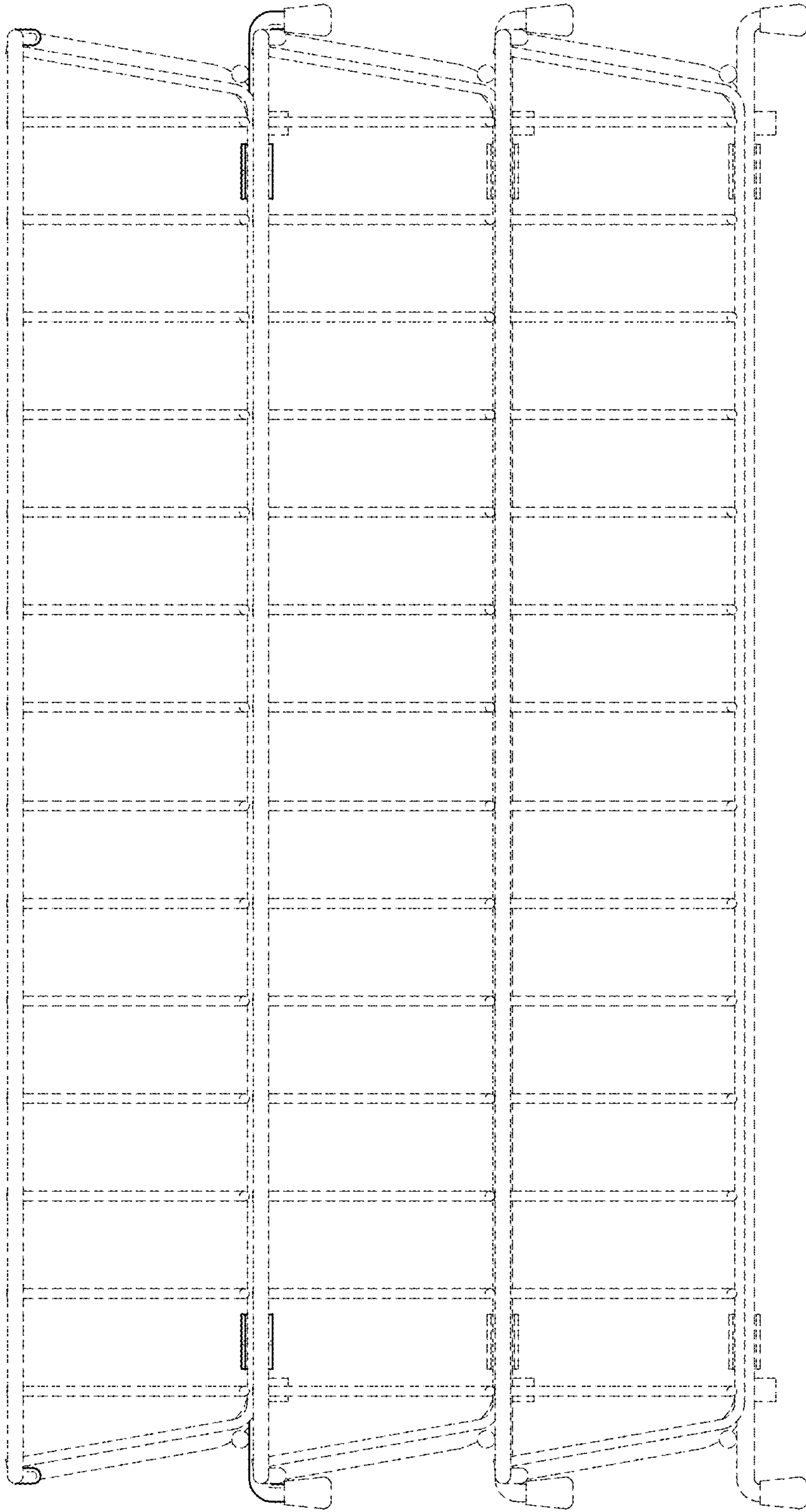

FIG. 3

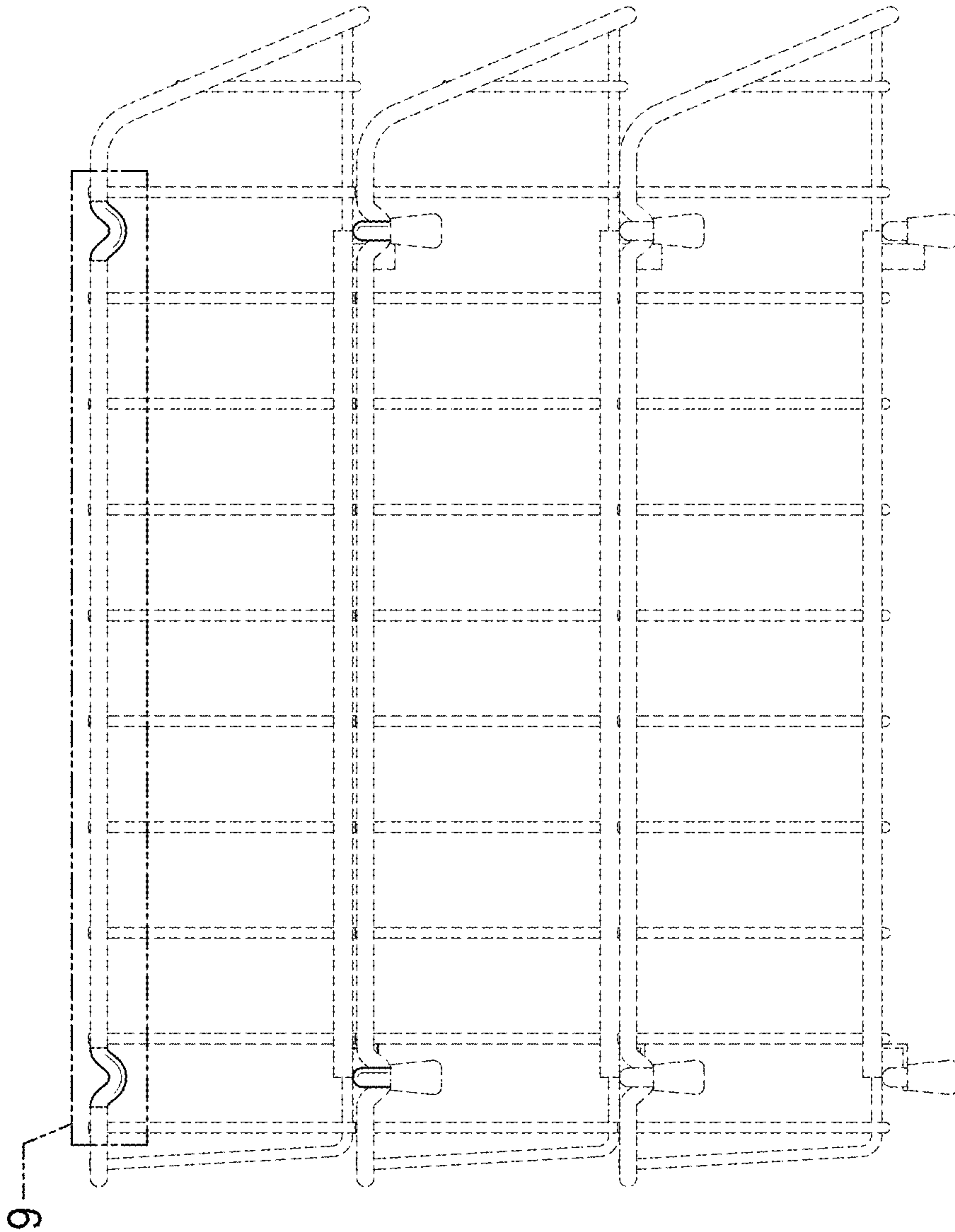

FIG. 4

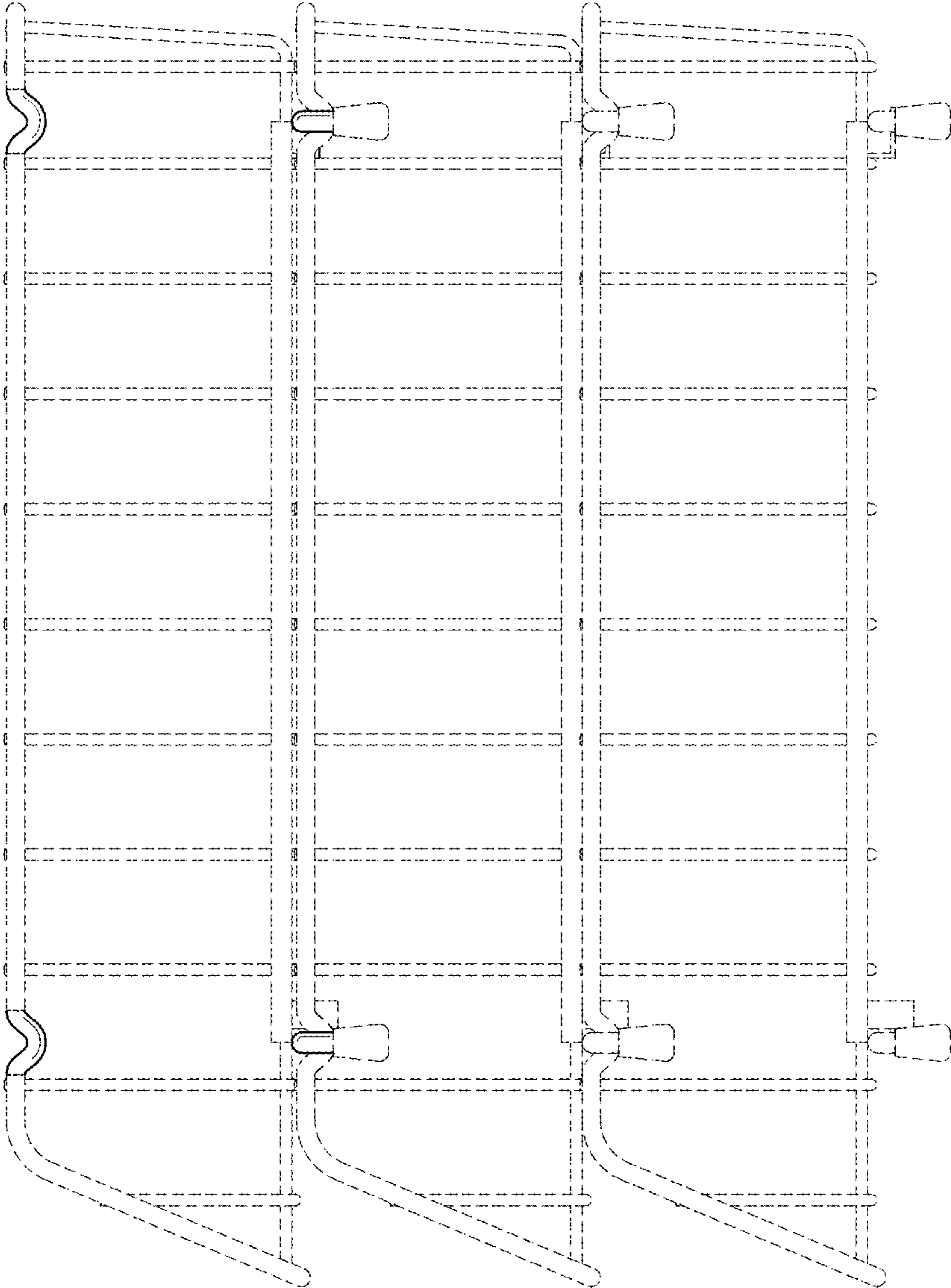

FIG. 5

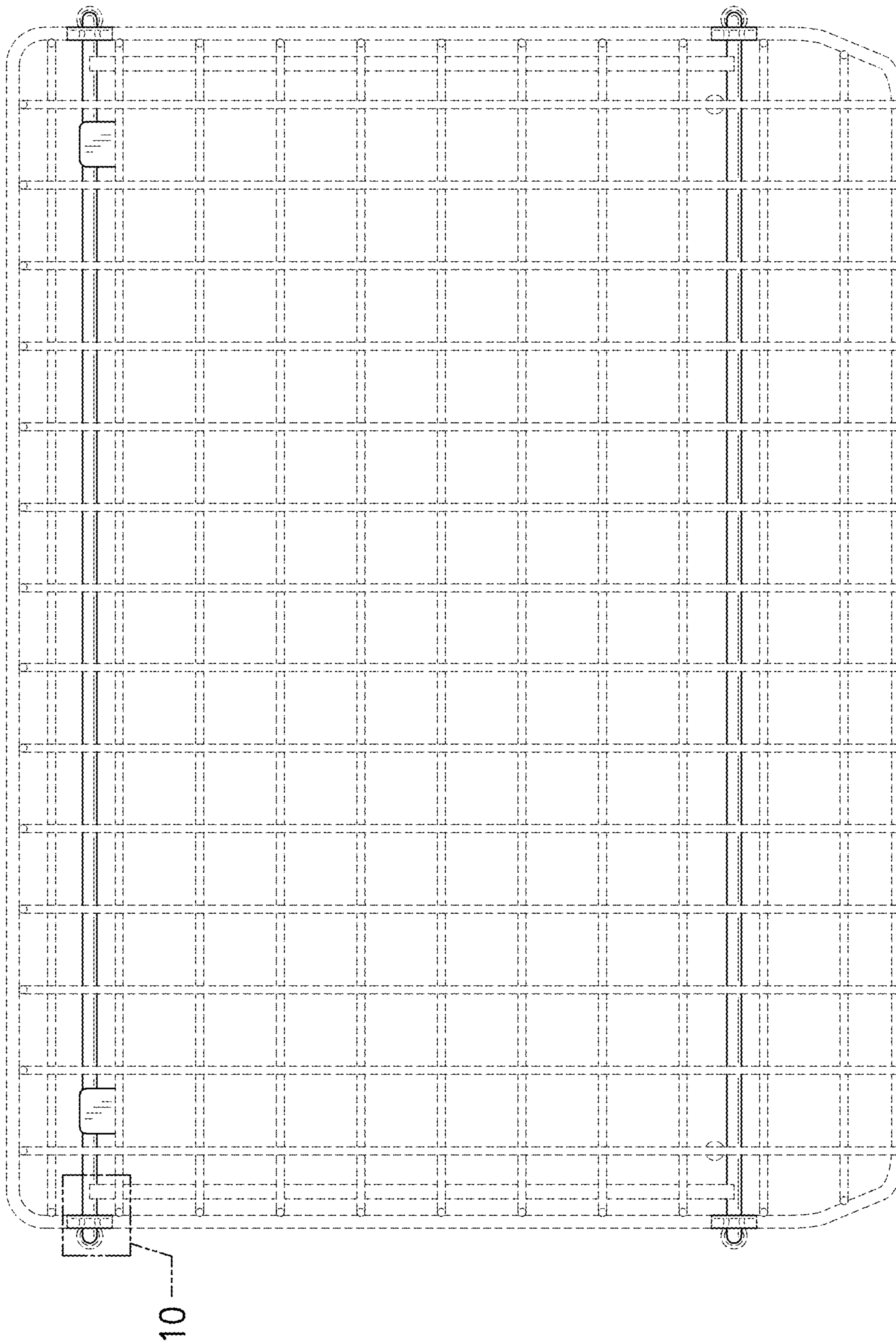

FIG. 6

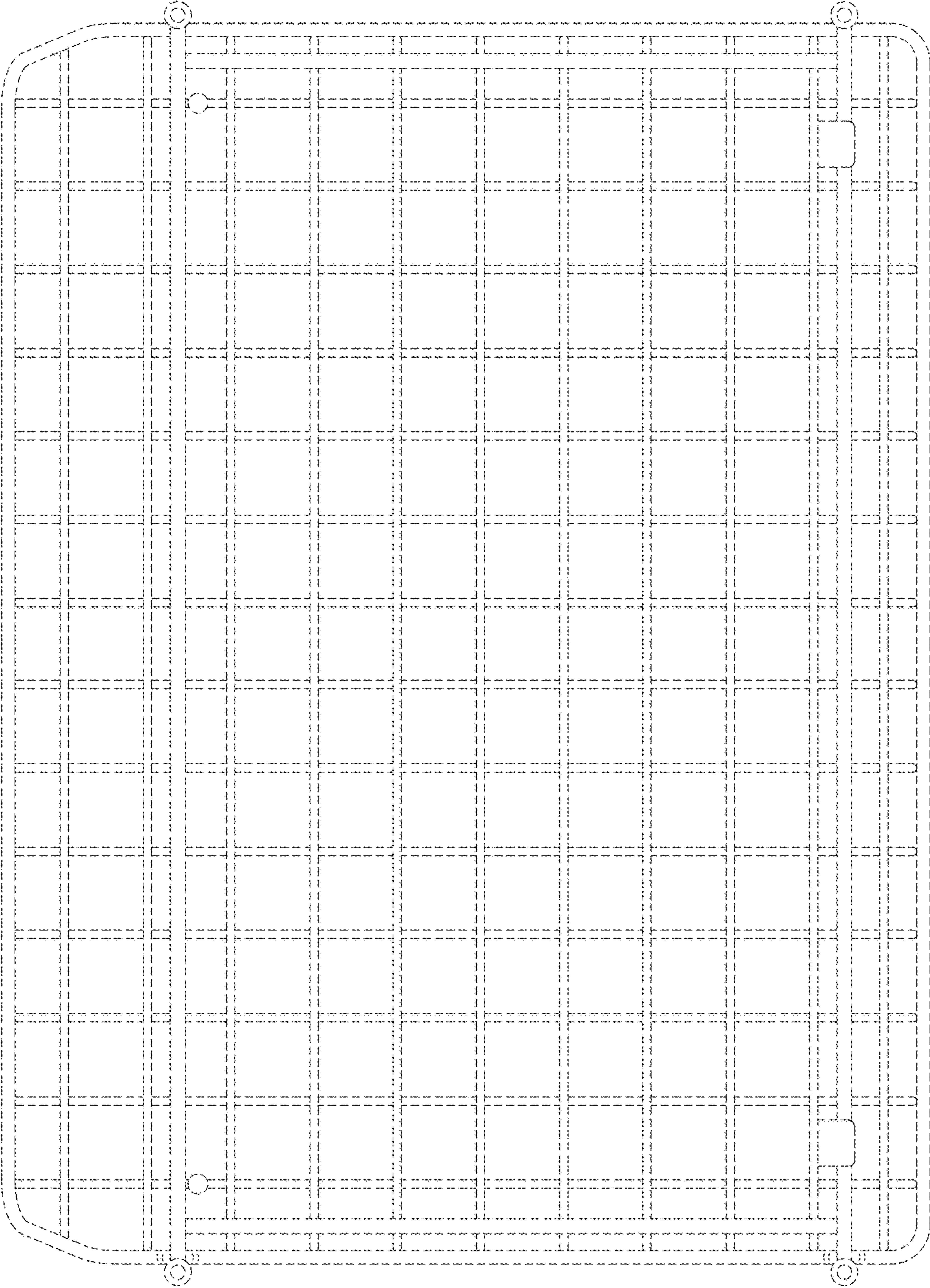

FIG. 7

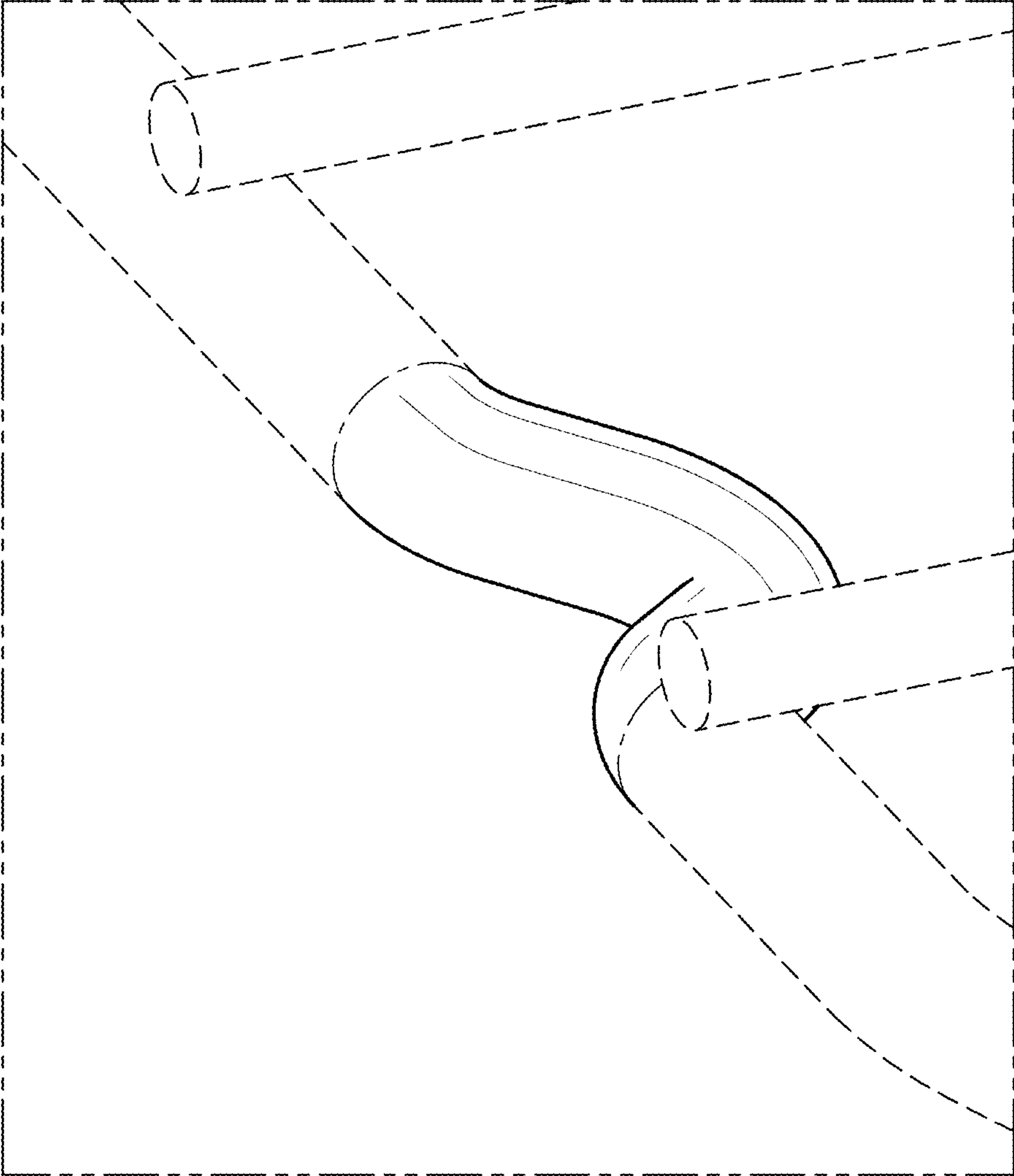

FIG. 8

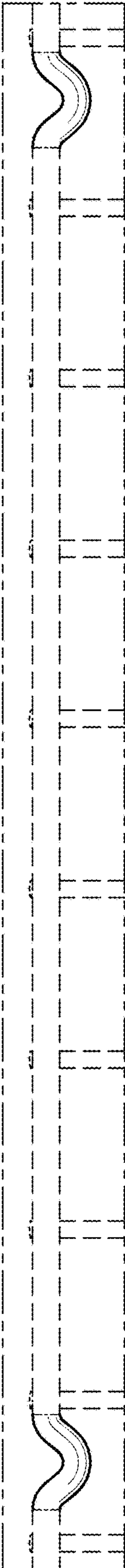

FIG. 9

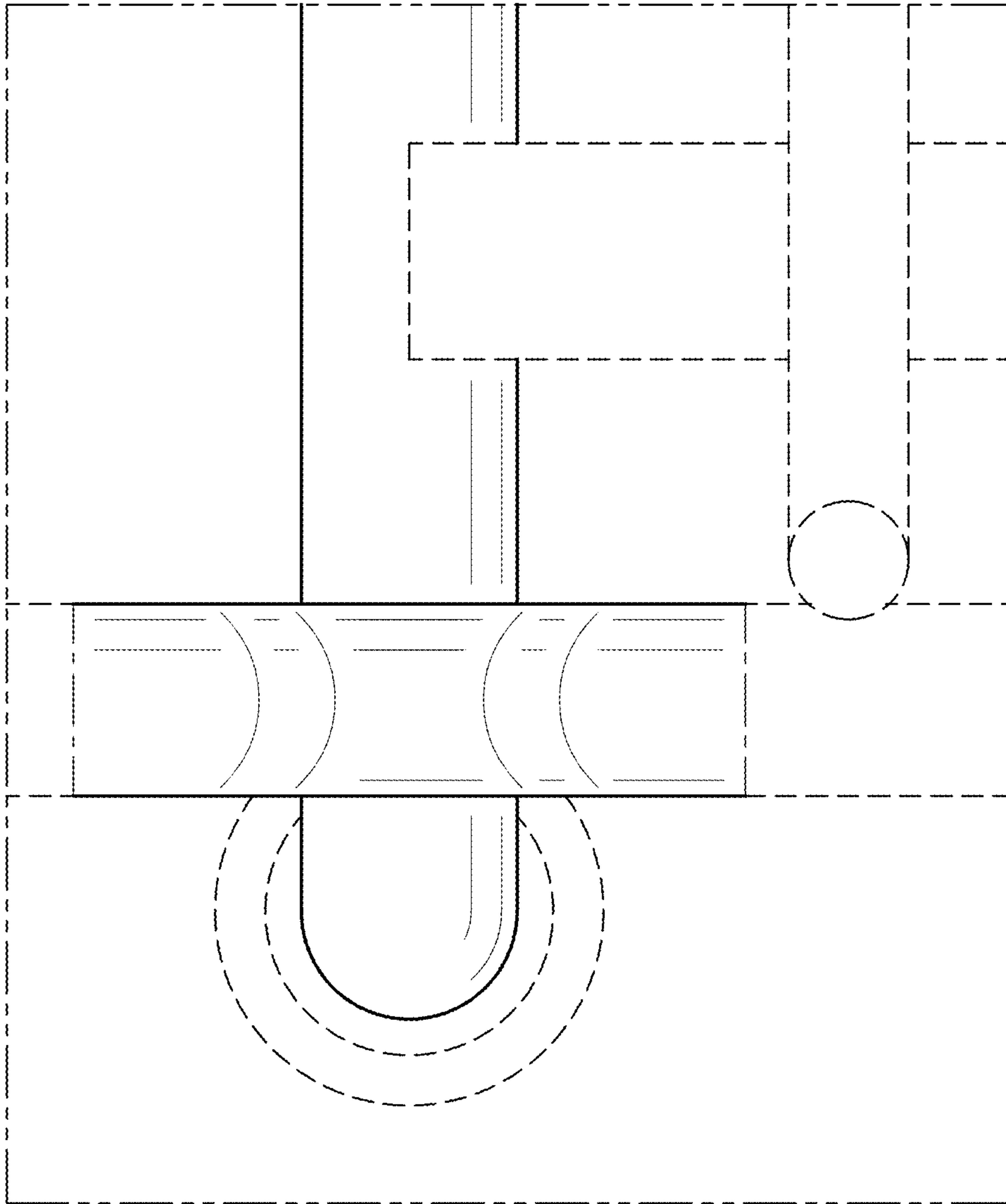

FIG. 10