



US00D987647S

(12) **United States Design Patent**
Liao et al.

(10) **Patent No.:** **US D987,647 S**
(45) **Date of Patent:** **** May 30, 2023**

(54) **KEYBOARD LEATHER SHEATH**

(71) Applicant: **HUAWEI TECHNOLOGIES CO., LTD.**, Guangdong (CN)

(72) Inventors: **Yuan Liao**, Wuhan (CN); **Jiaqi Zhou**, Shanghai (CN)

(73) Assignee: **HUAWEI TECHNOLOGIES CO., LTD.**, Shenzhen (CN)

(**) Term: **15 Years**

(21) Appl. No.: **29/807,321**

(22) Filed: **Sep. 10, 2021**

(30) **Foreign Application Priority Data**

Mar. 12, 2021 (CN) 202130134367.3

(51) **LOC (14) Cl.** **14-02**

(52) **U.S. Cl.**
USPC **D14/440**

(58) **Field of Classification Search**
USPC D14/440, 447, 250, 316; 361/679.55;
206/45.23, 320, 45.2; 294/25;

(Continued)

(56) **References Cited**

U.S. PATENT DOCUMENTS

D658,187 S * 4/2012 Diebel G06F 1/1679
D14/440

D658,188 S * 4/2012 Diebel D14/440
(Continued)

Primary Examiner — Cynthia R Underwood

(57) **CLAIM**

The ornamental design for keyboard leather sheath, as shown and described.

DESCRIPTION

FIG. 1 is a top front perspective view of a first embodiment of a keyboard leather sheath showing our new design in a closed position;

FIG. 2 is a front view thereof;
FIG. 3 is a back view thereof;
FIG. 4 is a top view thereof;
FIG. 5 is a bottom view thereof;
FIG. 6 is a right side view thereof;
FIG. 7 is a left side view thereof;
FIG. 8 is a front perspective view of the first embodiment in an open position;

FIG. 9 is a front view thereof;
FIG. 10 is a back view thereof;
FIG. 11 is a top view thereof;
FIG. 12 is a bottom view thereof;
FIG. 13 is a right view thereof;
FIG. 14 is a left view thereof;
FIG. 15 is a front perspective view thereof, shown in an environmental use;

FIG. 16 is a top front perspective view of a second embodiment of a keyboard leather sheath showing our new design in a closed position;

FIG. 17 is a front view thereof;
FIG. 18 is a back view thereof;
FIG. 19 is a top view thereof;
FIG. 20 is a bottom view thereof;
FIG. 21 is a right side view thereof;
FIG. 22 is a left side view thereof;
FIG. 23 is a front perspective view of the second embodiment in an open position;

FIG. 24 is a front view thereof;
FIG. 25 is a back view thereof;
FIG. 26 is a top view thereof;
FIG. 27 is a bottom view thereof;
FIG. 28 is a right view thereof;
FIG. 29 is a left view thereof;
FIG. 30 is a front perspective view thereof, shown in an environmental use;

FIG. 31 is a top front perspective view of a third embodiment of a keyboard leather sheath showing our new design in a closed position;

FIG. 32 is a front view thereof;
FIG. 33 is a back view thereof;
FIG. 34 is a top view thereof;
FIG. 35 is a bottom view thereof;
FIG. 36 is a right side view thereof;
FIG. 37 is a left side view thereof;

(Continued)

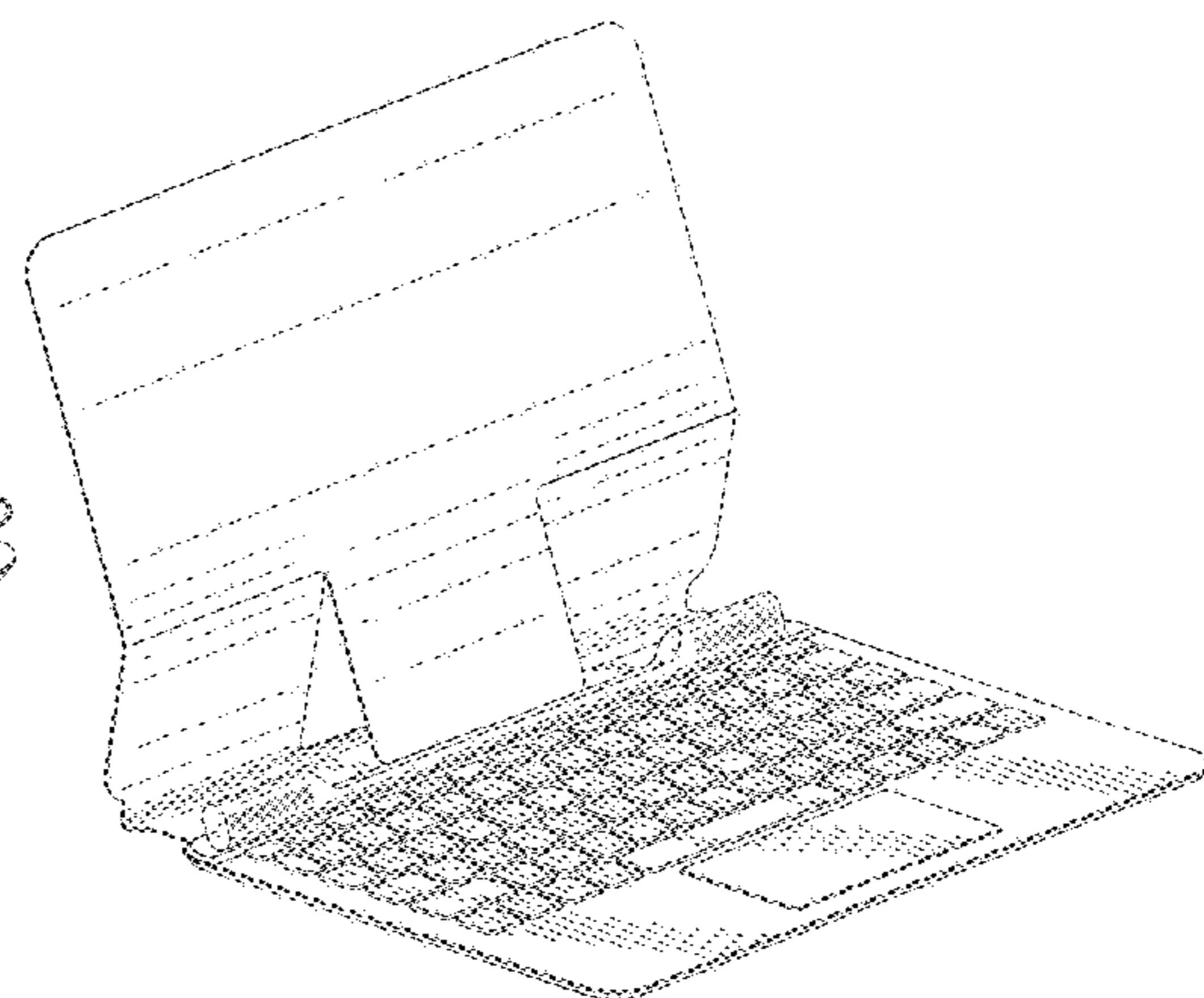
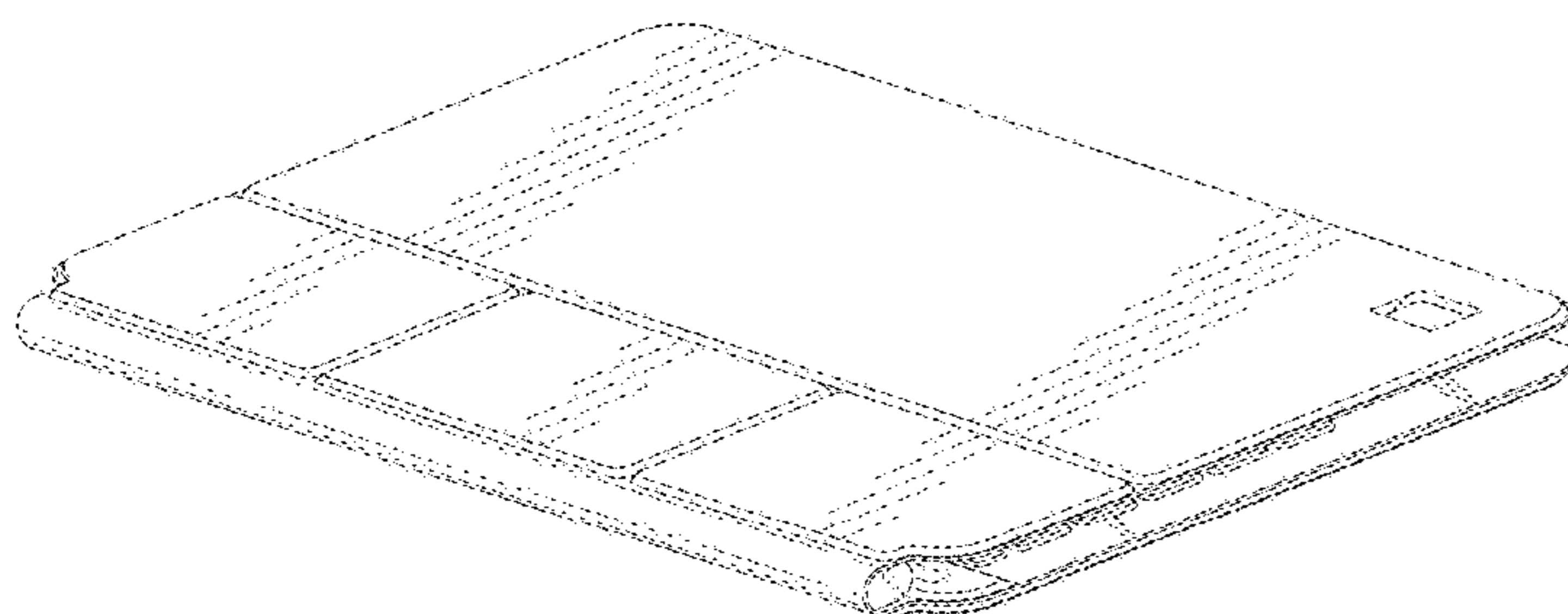

FIG. 38 is a front perspective view of the third embodiment in an open position;
 FIG. 39 is a front view thereof;
 FIG. 40 is a back view thereof;
 FIG. 41 is a top view thereof;
 FIG. 42 is a bottom view thereof;
 FIG. 43 is a right view thereof;
 FIG. 44 is a left view thereof; and,
 FIG. 45 is a front perspective view thereof, shown in an environmental use.
 The broken lines in drawings show portions of the keyboard leather sheath that form no part of the claimed design.

1 Claim, 39 Drawing Sheets

(58) **Field of Classification Search**

USPC 455/575.8; D3/289, 301, 283, 265, 243, D3/249, 294, 284, 274, 303, 266, 203.1, D3/315, 276
 CPC ... G06F 1/1628; G06F 1/1626; A47B 23/044; A45C 11/00; A45C 13/02; H04B 1/3888
 See application file for complete search history.

(56) **References Cited**

U.S. PATENT DOCUMENTS

8,245,843 B1 * 8/2012 Wu H01M 10/465
 206/320
 8,312,991 B2 * 11/2012 Diebel G06F 1/1628
 206/45.24
 D678,885 S * 3/2013 Gengler D14/447
 D684,983 S * 6/2013 Wu D14/455
 D691,142 S * 10/2013 Diebel G06F 1/1679
 D14/440
 8,640,864 B2 * 2/2014 Chen G06F 1/1626
 206/45.2
 D702,673 S * 4/2014 Murchison D14/250
 D704,689 S * 5/2014 Chang D14/250
 D706,783 S * 6/2014 Almodova D14/440
 D707,229 S * 6/2014 Almodova D14/440
 8,757,375 B2 * 6/2014 Huang A47B 23/043
 206/45.24
 D708,838 S * 7/2014 Lee D3/201
 8,763,795 B1 * 7/2014 Oten B65D 85/00
 206/45.24

8,783,458 B2 * 7/2014 Gallagher A45C 11/00
 206/320
 D710,859 S * 8/2014 Mecchella D14/440
 8,797,132 B2 * 8/2014 Childs A45C 11/00
 335/219
 D713,847 S * 9/2014 Su D14/440
 D713,848 S * 9/2014 Akana D14/440
 D730,913 S * 6/2015 Shao D14/440
 D734,760 S * 7/2015 Brunner D14/440
 9,451,818 B2 * 9/2016 Buechin A45C 13/1069
 D783,589 S * 4/2017 Tattari D14/250
 D784,995 S * 4/2017 Akana D14/440
 D807,891 S * 1/2018 Yeo D14/440
 D857,023 S * 8/2019 Hyun D14/440
 D871,415 S * 12/2019 Lin D14/440
 D886,112 S * 6/2020 Yeh D14/455
 10,905,211 B2 * 2/2021 Nyholm A45C 15/00
 D920,337 S * 5/2021 Chan D14/440
 D921,637 S * 6/2021 Cheng D14/440
 D928,788 S * 8/2021 Kang D14/440
 D942,459 S * 2/2022 Akana D14/440
 D942,460 S * 2/2022 Akana D14/440
 D944,804 S * 3/2022 Diebel G06F 1/1628
 D14/440
 D949,867 S * 4/2022 Wu D14/440
 D960,154 S * 8/2022 Akana D14/345
 2003/0034263 A1 * 2/2003 D'Hoste A45C 9/00
 206/320
 2008/0302687 A1 * 12/2008 Sirichai A45C 11/00
 206/320
 2011/0266194 A1 * 11/2011 Bau H04B 1/3888
 206/736
 2012/0194448 A1 * 8/2012 Rothkopf G06F 1/1643
 361/679.01
 2012/0211377 A1 * 8/2012 Sajid G06F 1/1628
 206/216
 2012/0211613 A1 * 8/2012 Yang A45C 11/00
 248/174
 2012/0305413 A1 * 12/2012 Chung A45C 11/00
 206/45.23
 2013/0093304 A1 * 4/2013 Childs F16M 11/10
 312/240
 2013/0140203 A1 * 6/2013 Chiang G06F 1/1628
 206/320
 2015/0151871 A1 * 6/2015 Huang H05K 5/0086
 206/45.23
 2015/0237979 A1 * 8/2015 Huang A45C 11/00
 206/45.25

* cited by examiner

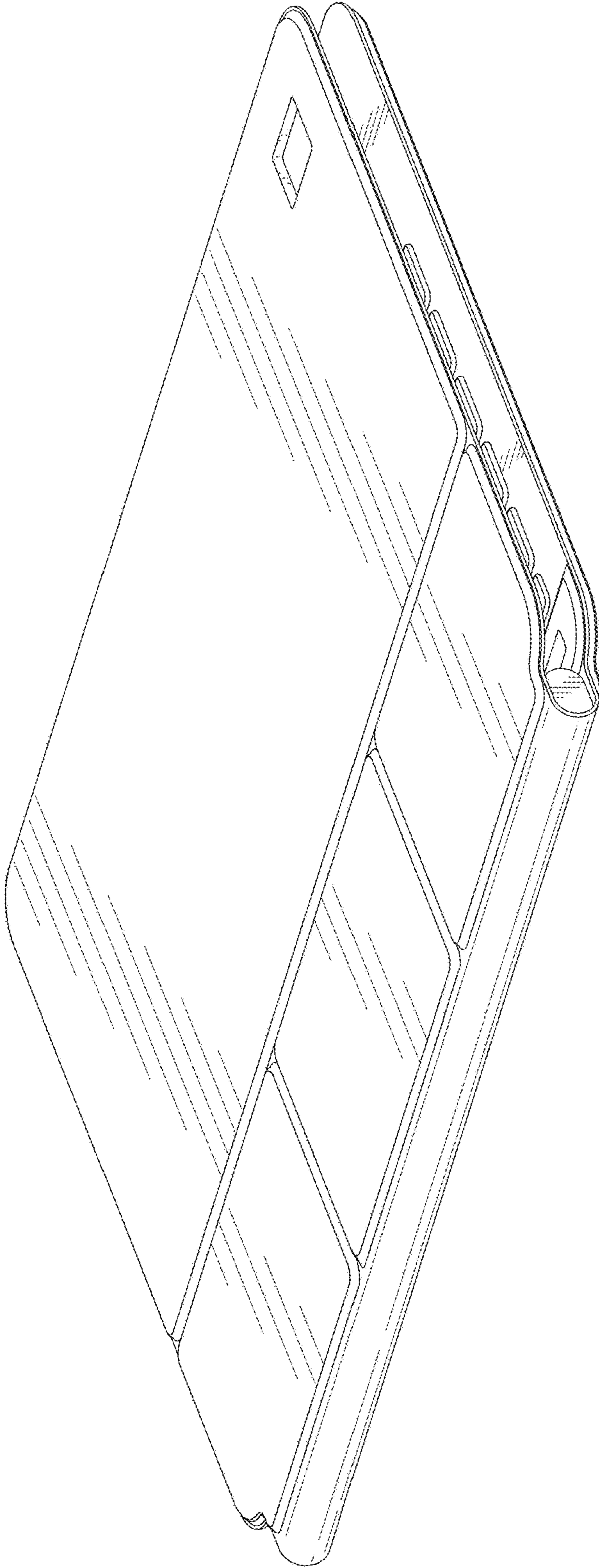

FIG. 1

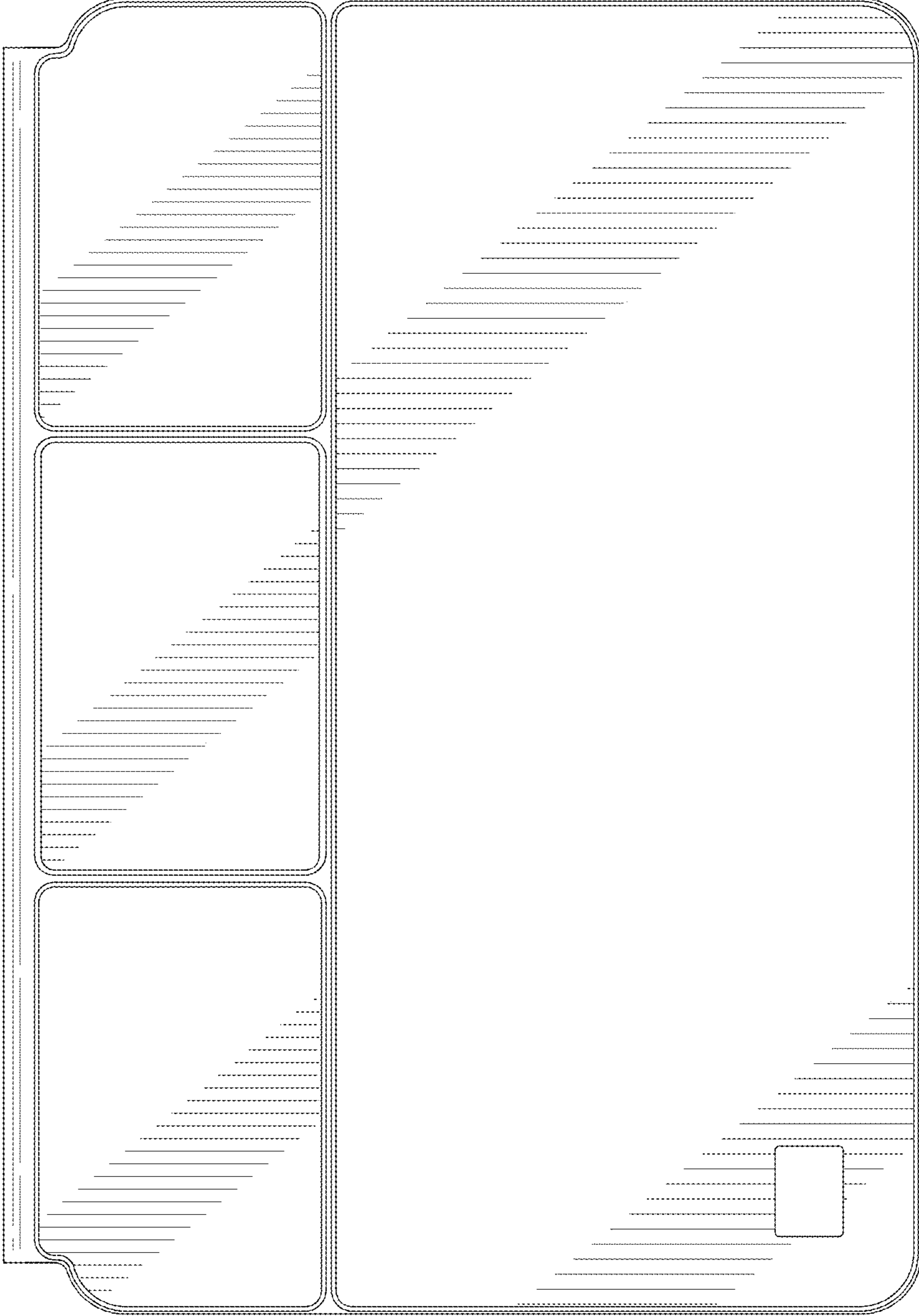

FIG. 2

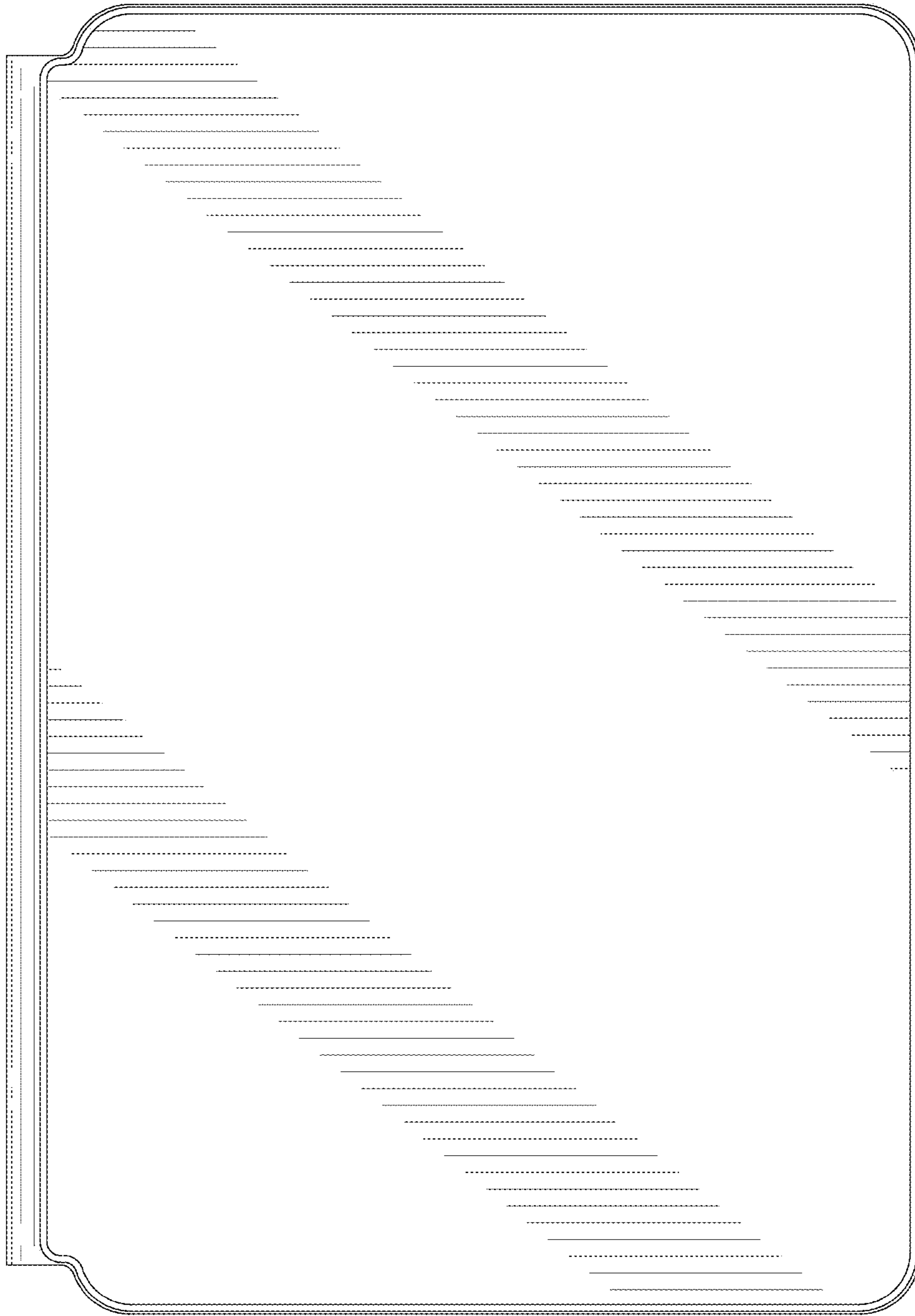

FIG. 3

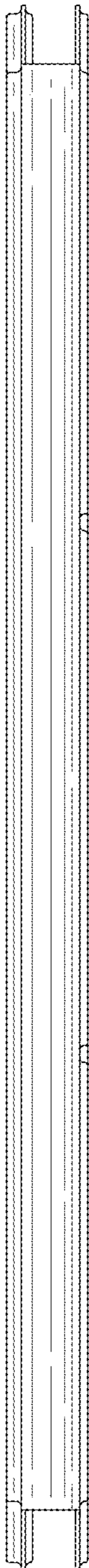

FIG. 4

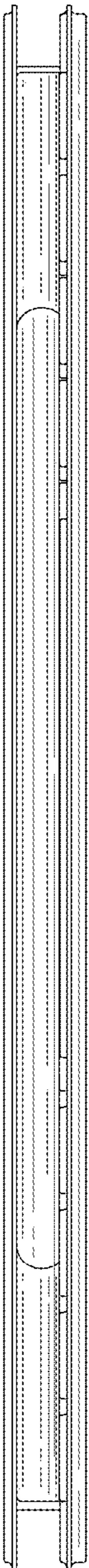

FIG. 5



FIG. 7

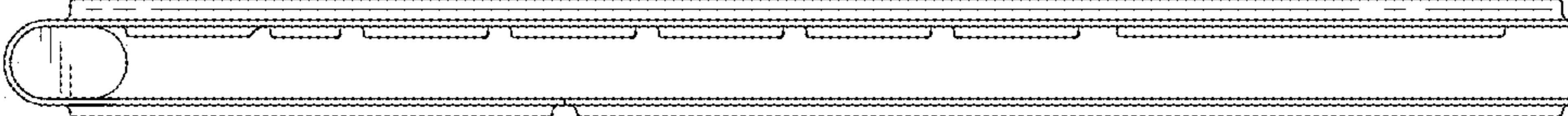

FIG. 6

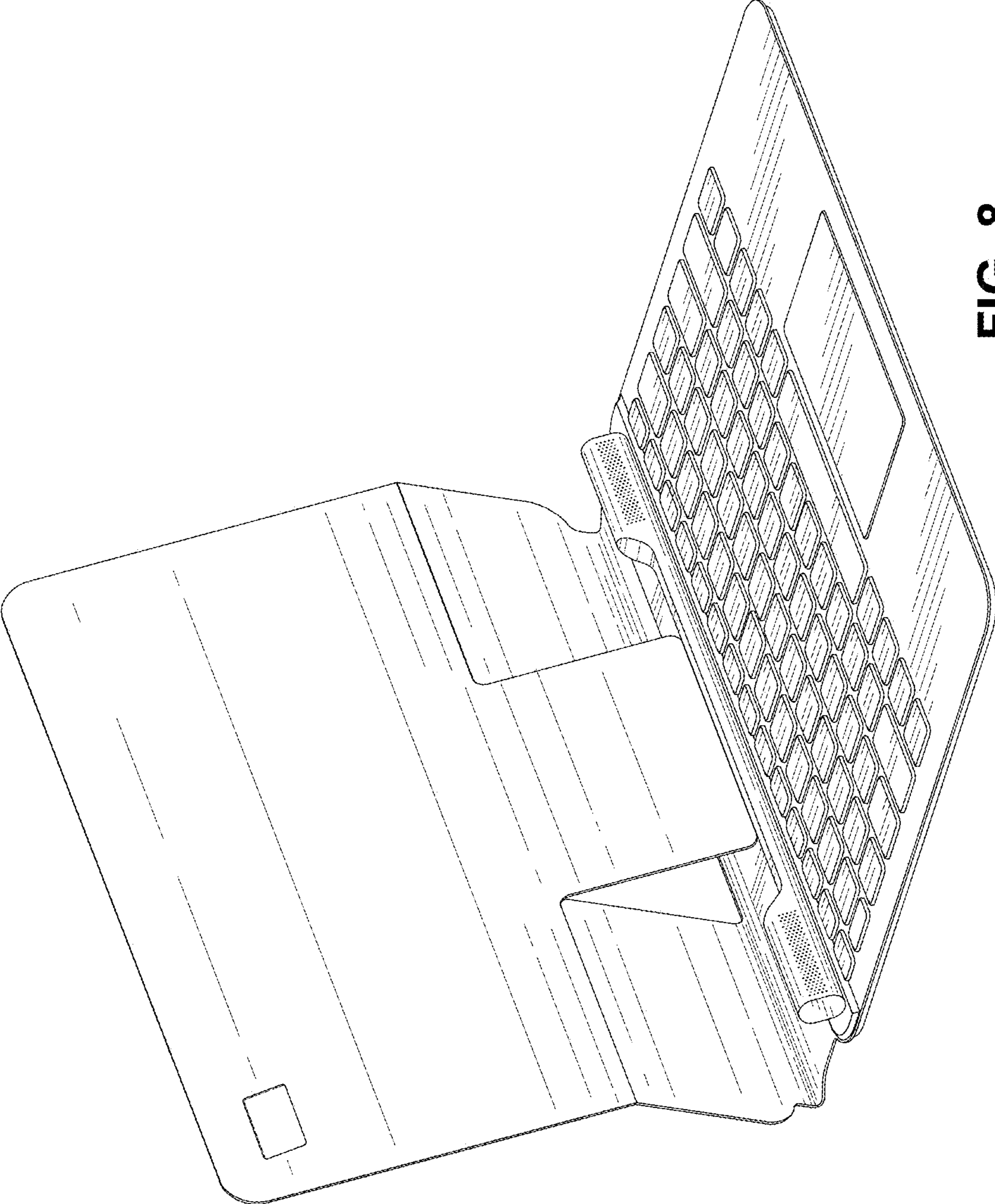

FIG. 8

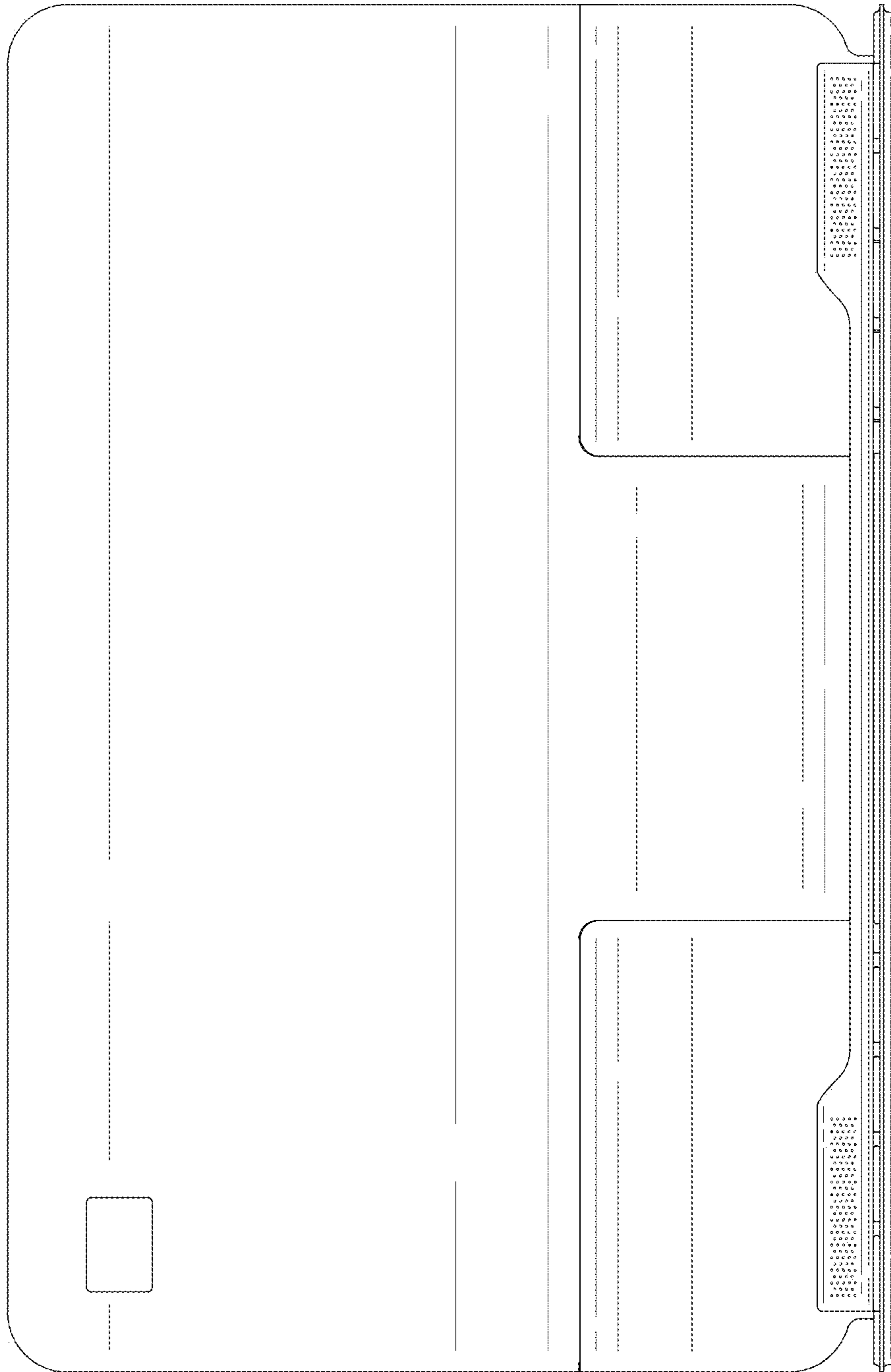

FIG. 9

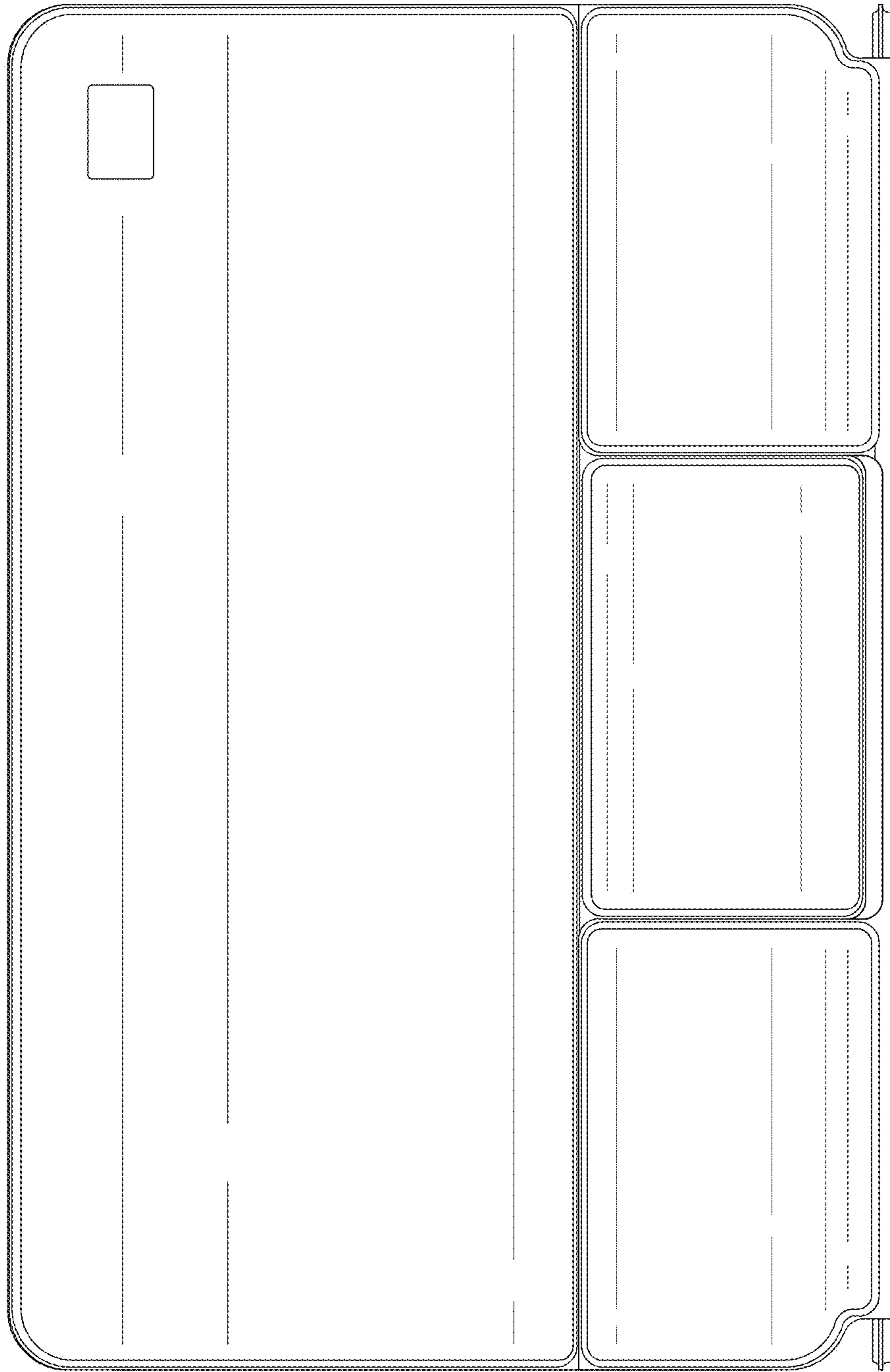

FIG. 10

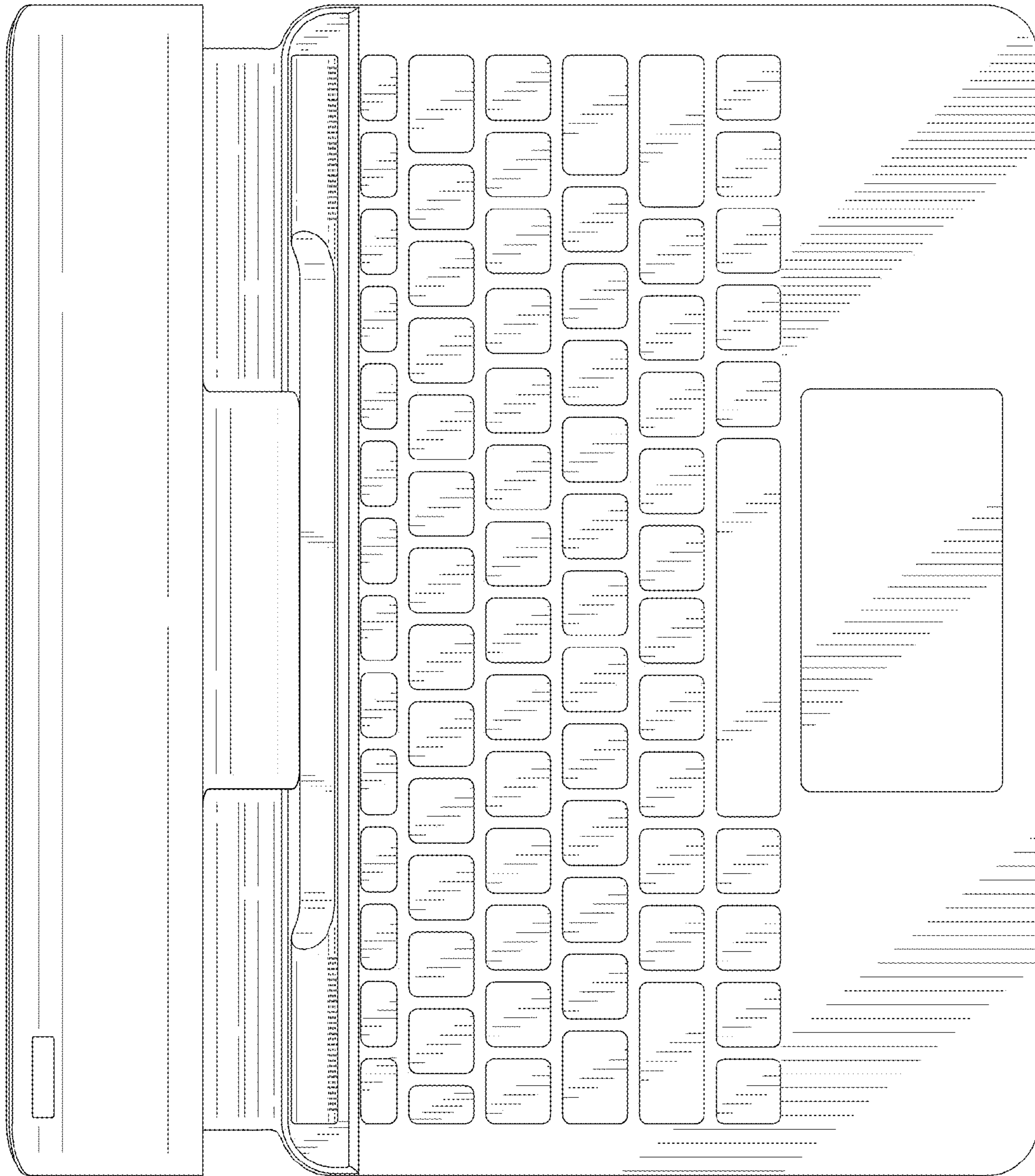

FIG. 11

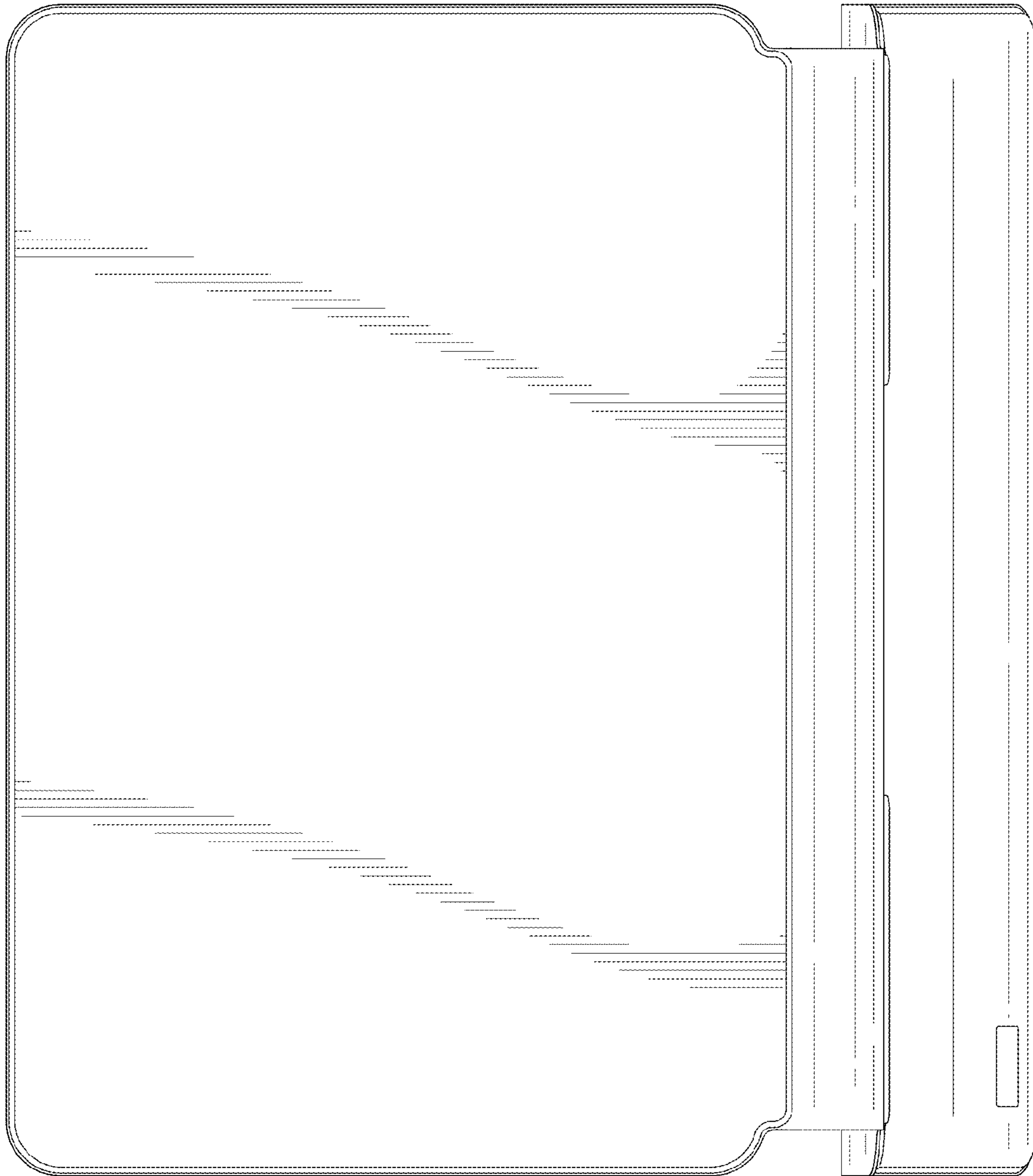

FIG. 12

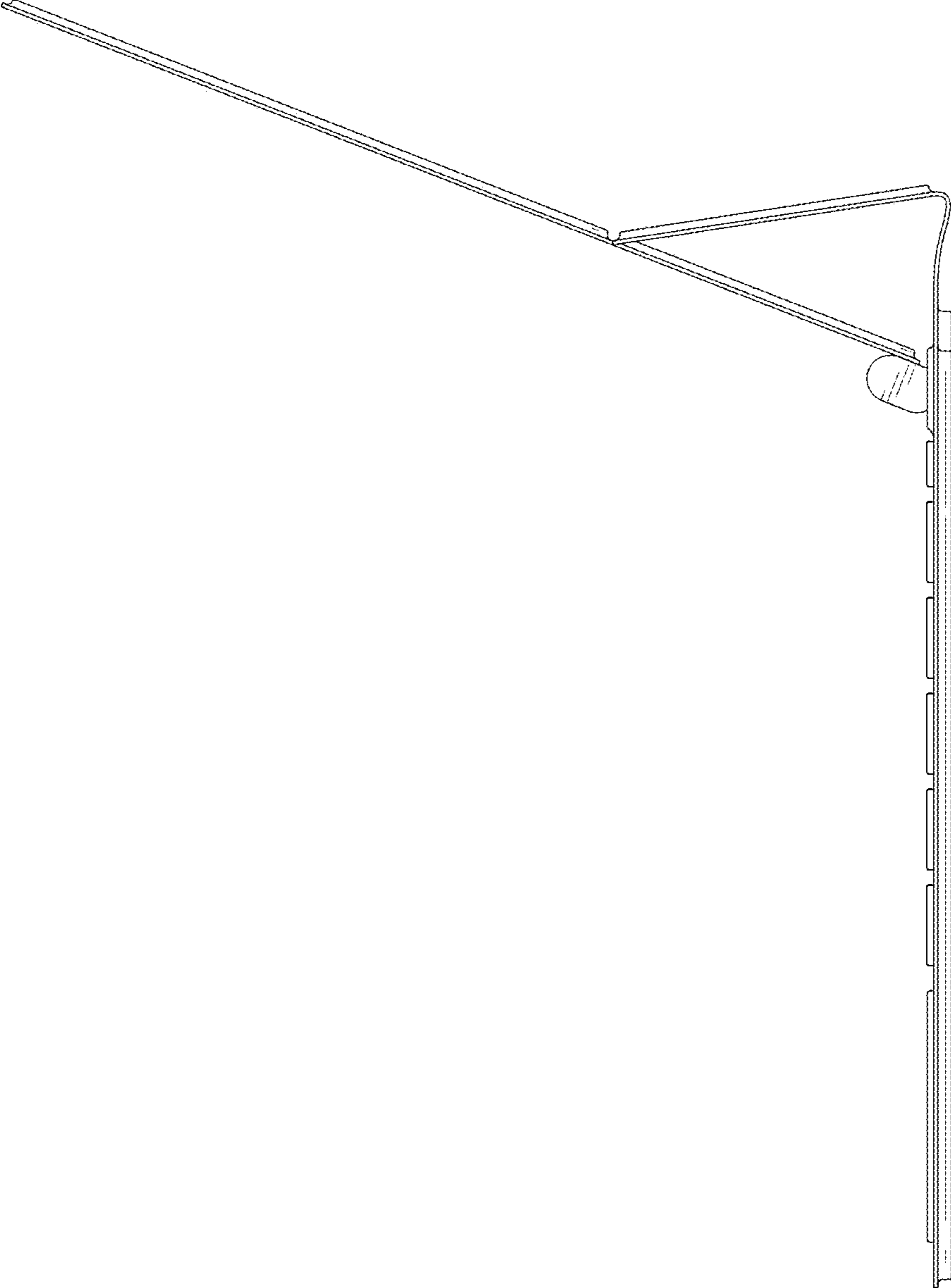

FIG. 13

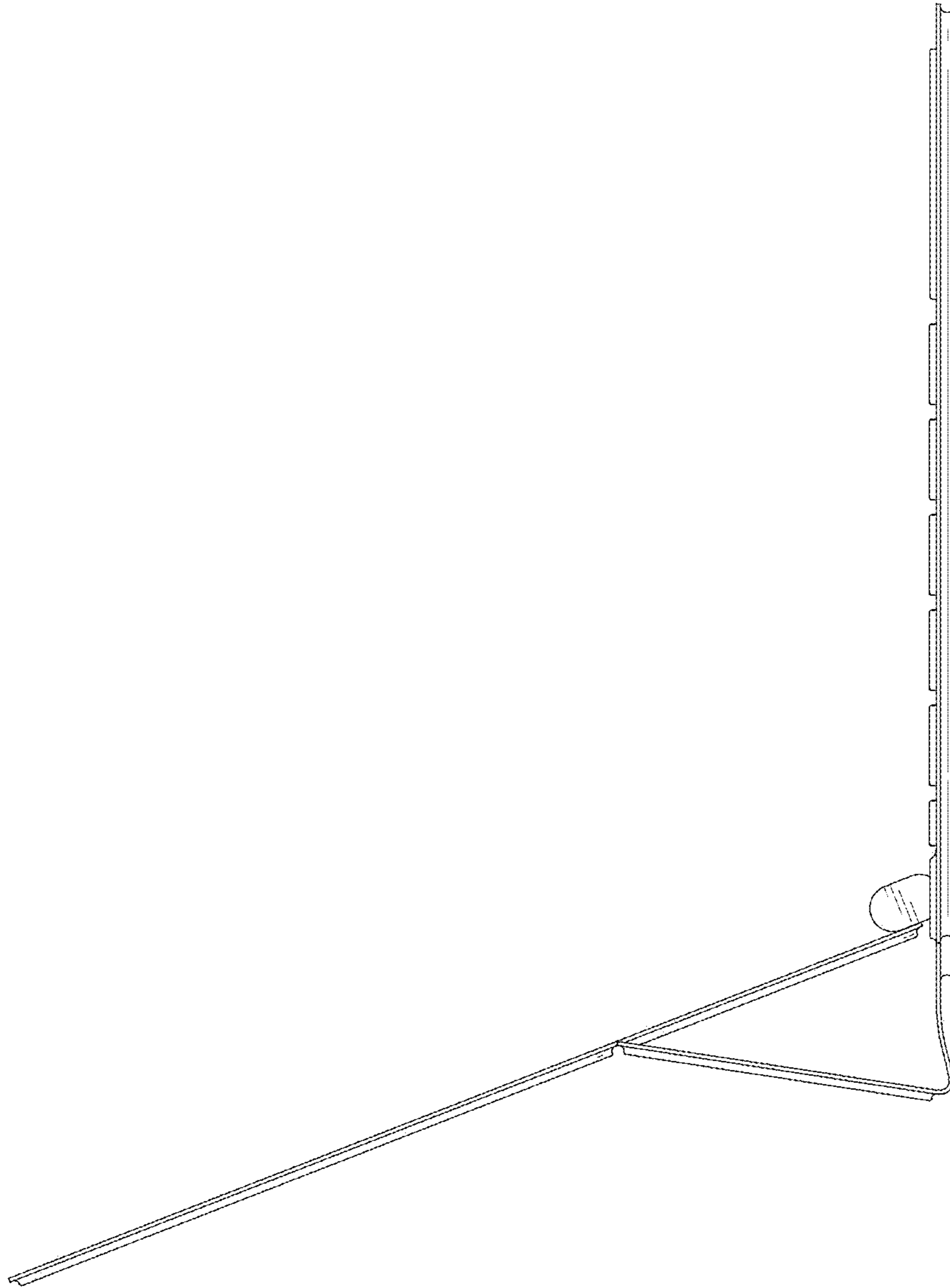

FIG. 14

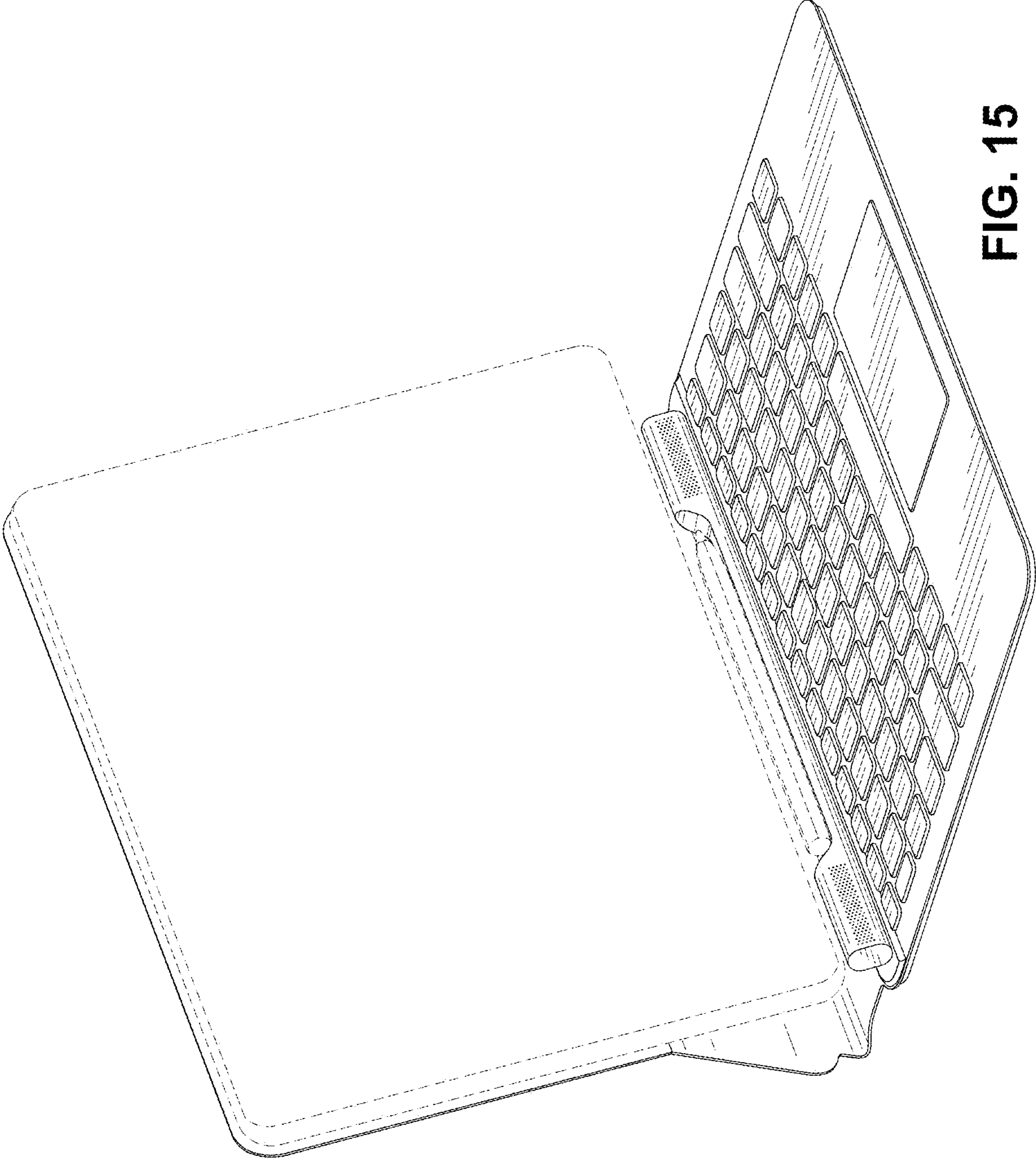

FIG. 15

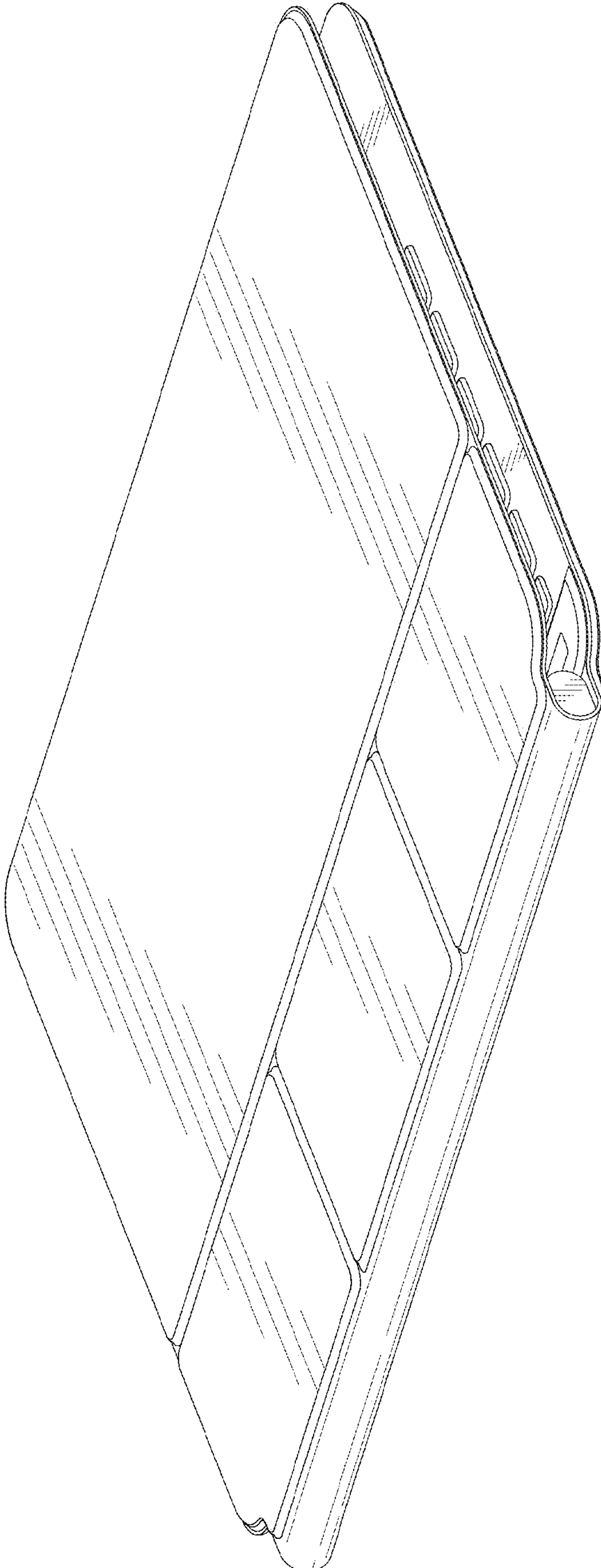

FIG. 16

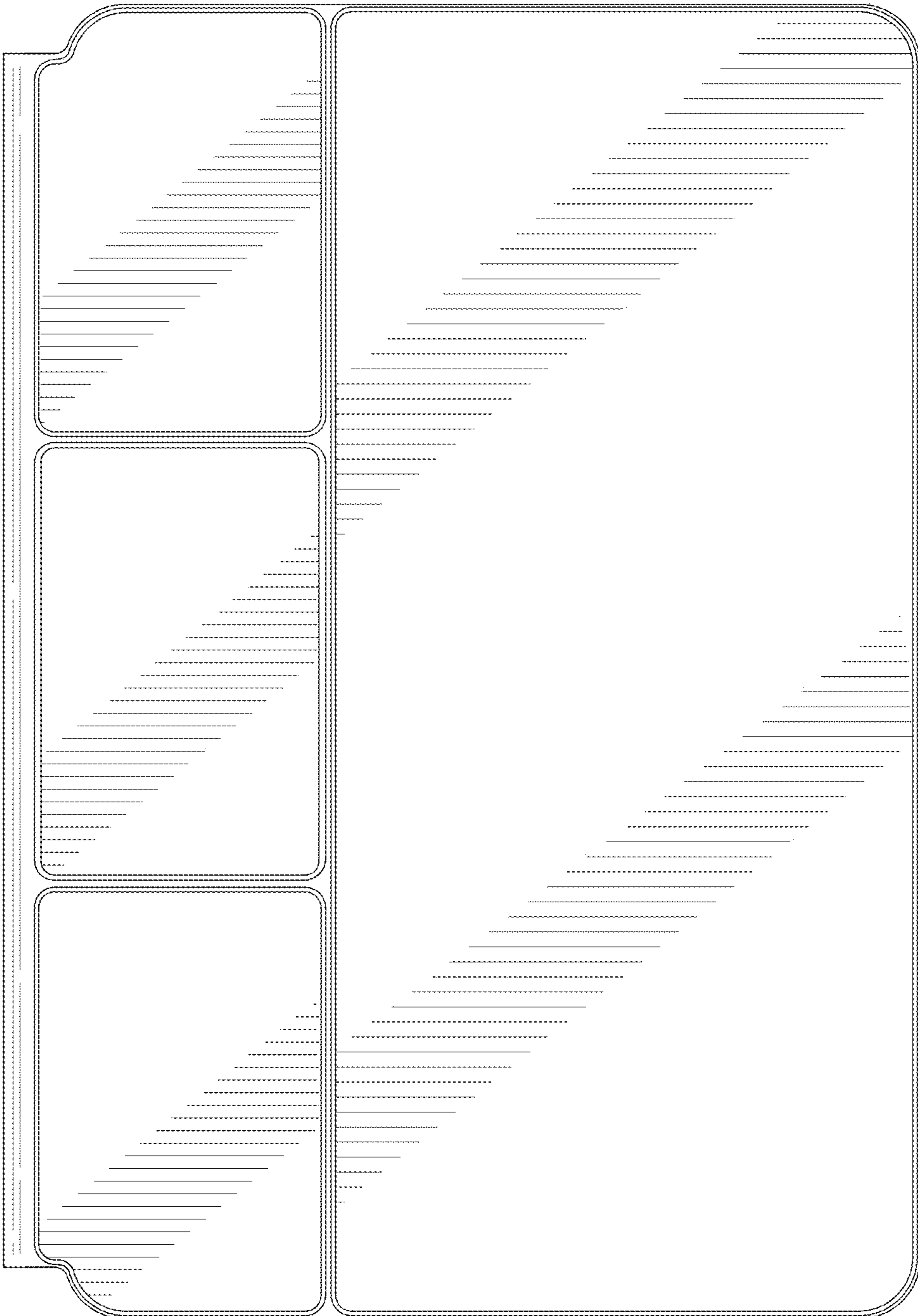

FIG. 17

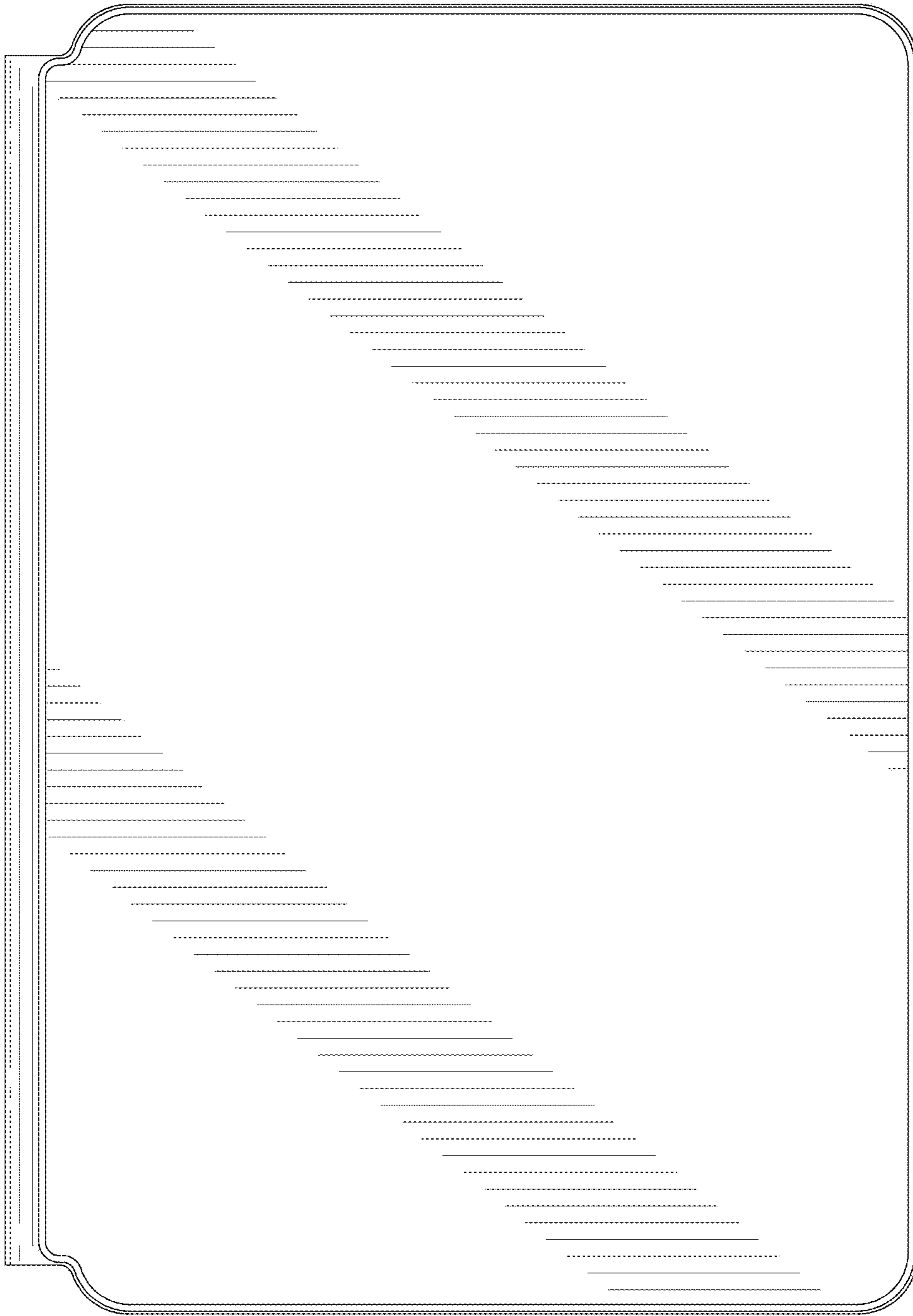

FIG. 18

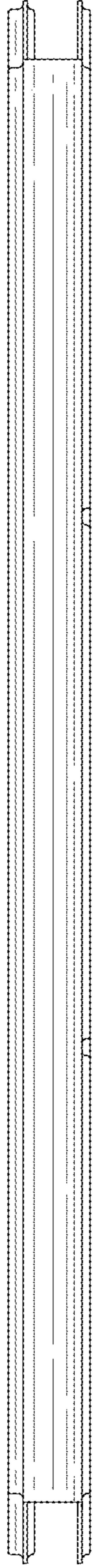

FIG. 19

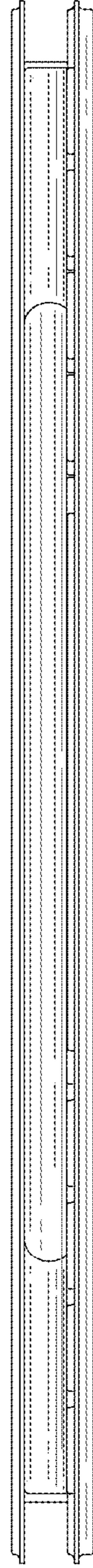

FIG. 20

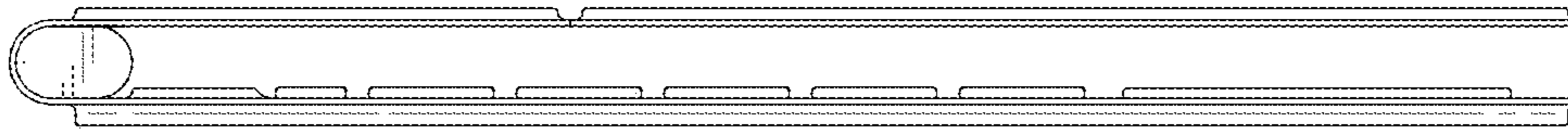

FIG. 22

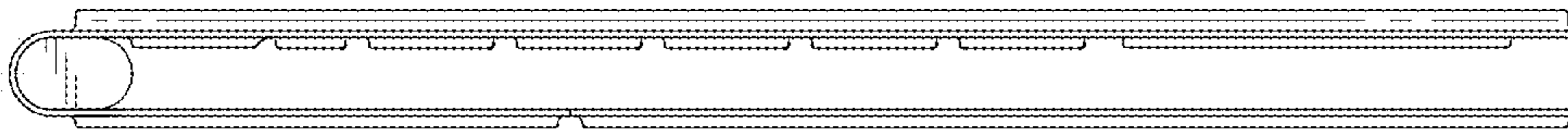

FIG. 21

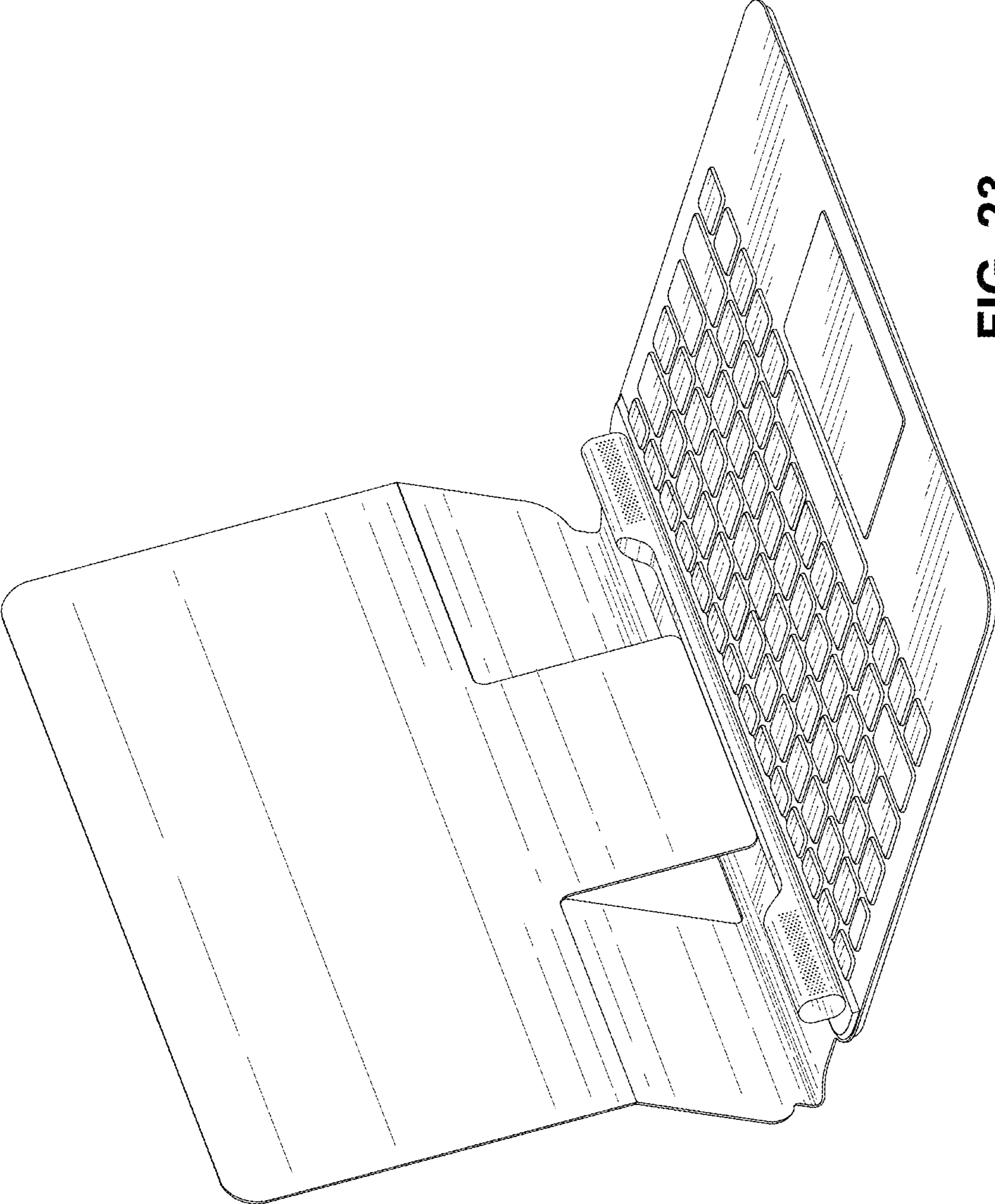

FIG. 23

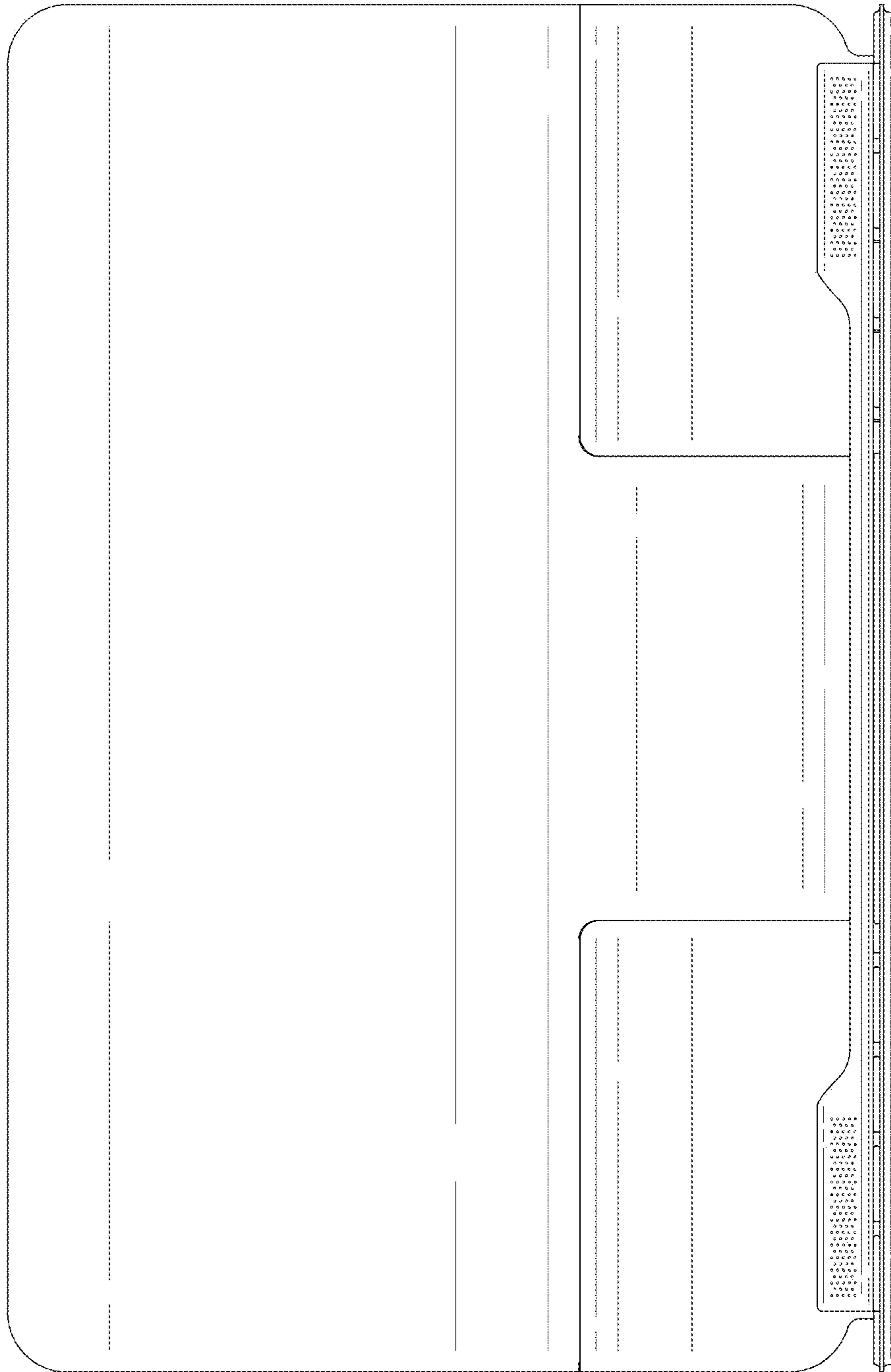

FIG. 24

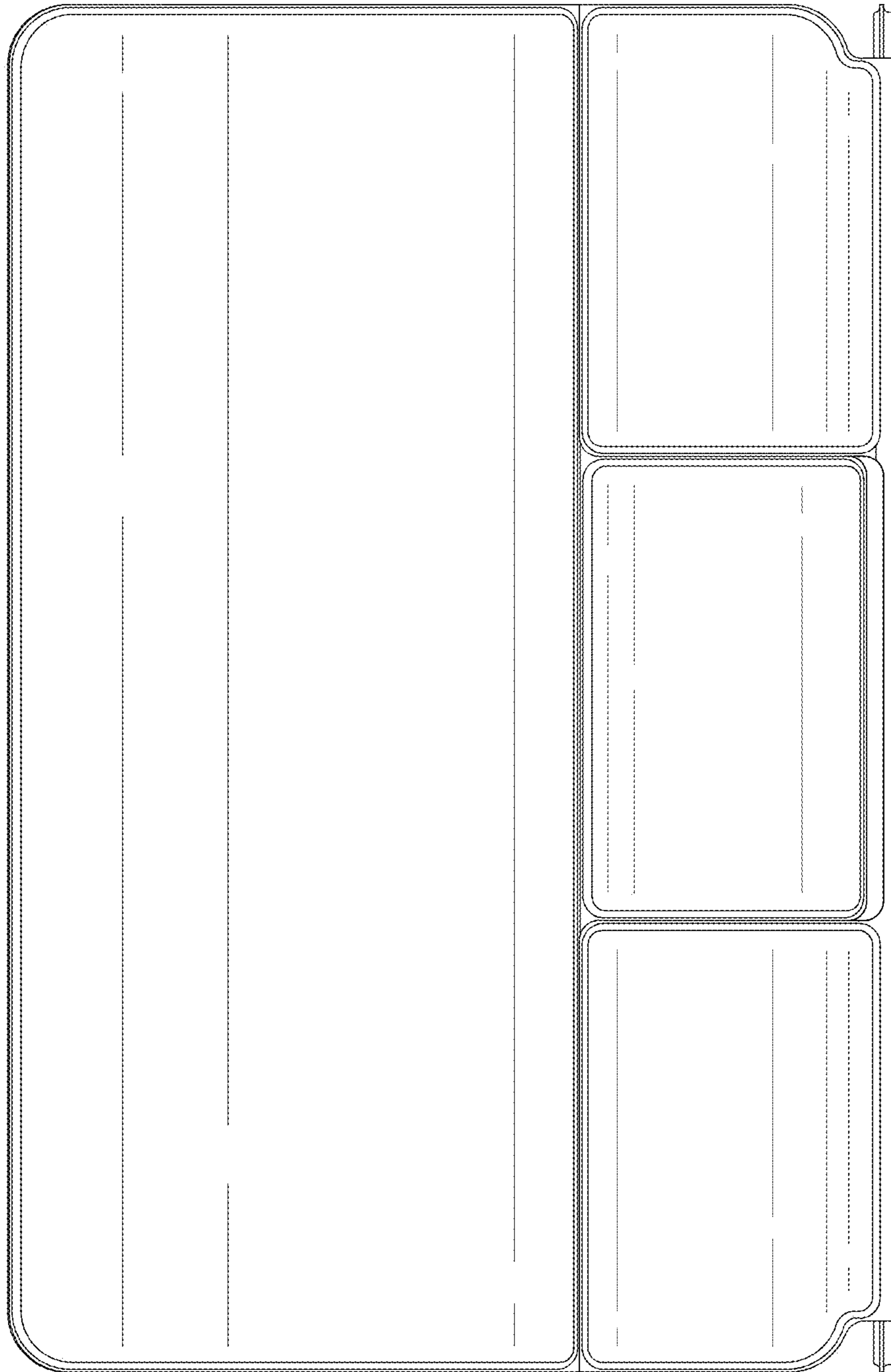

FIG. 25

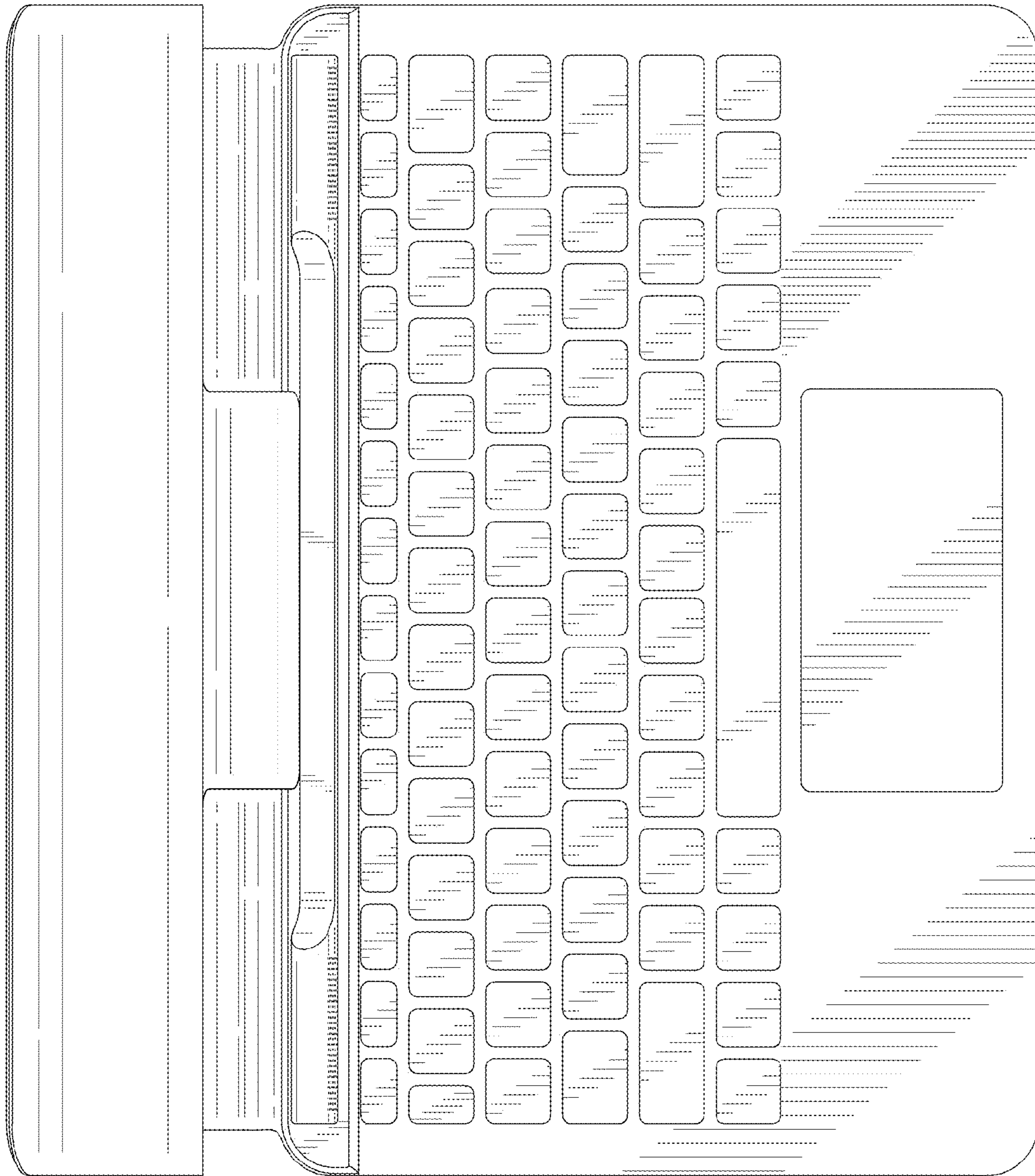

FIG. 26

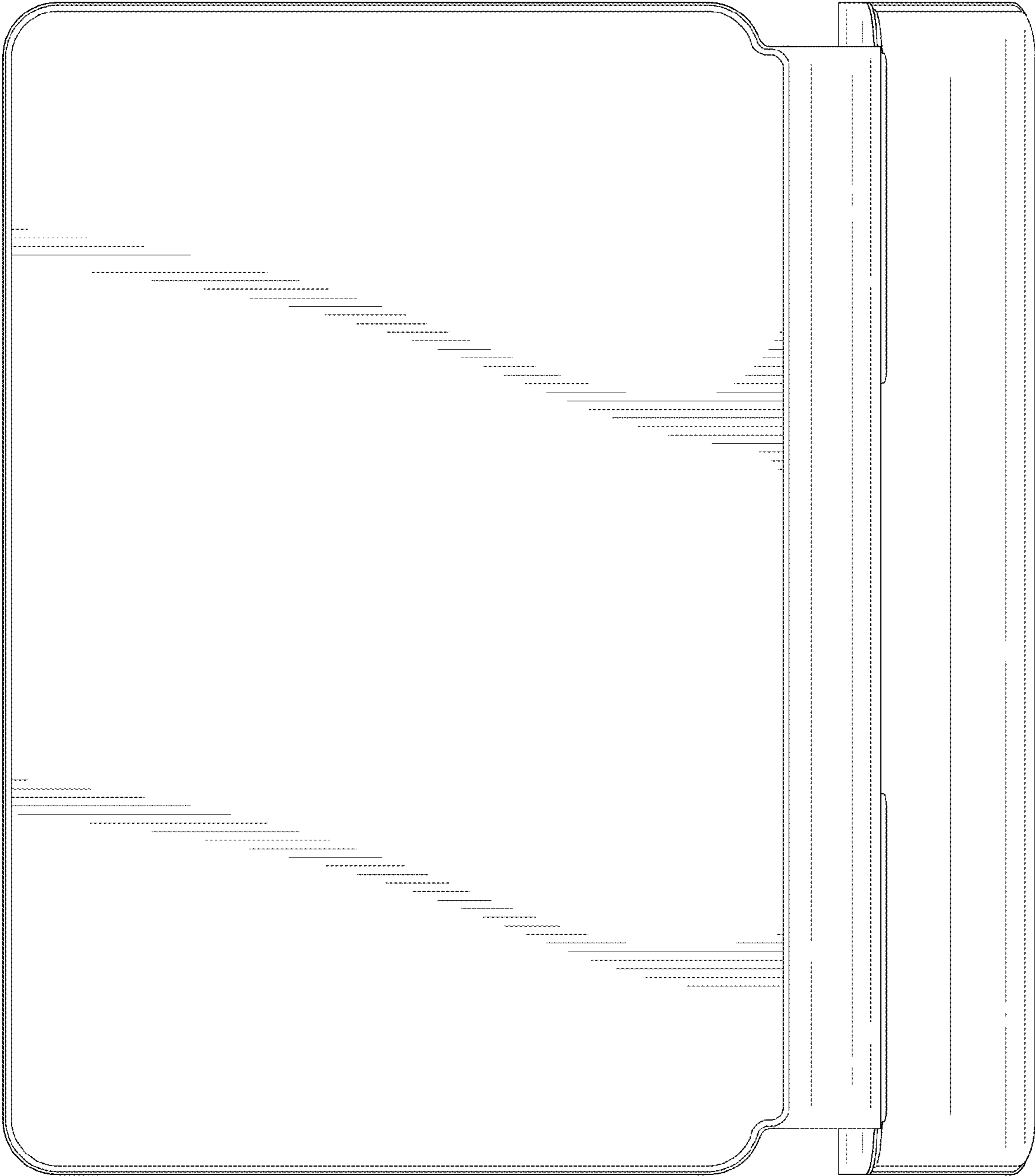

FIG. 27

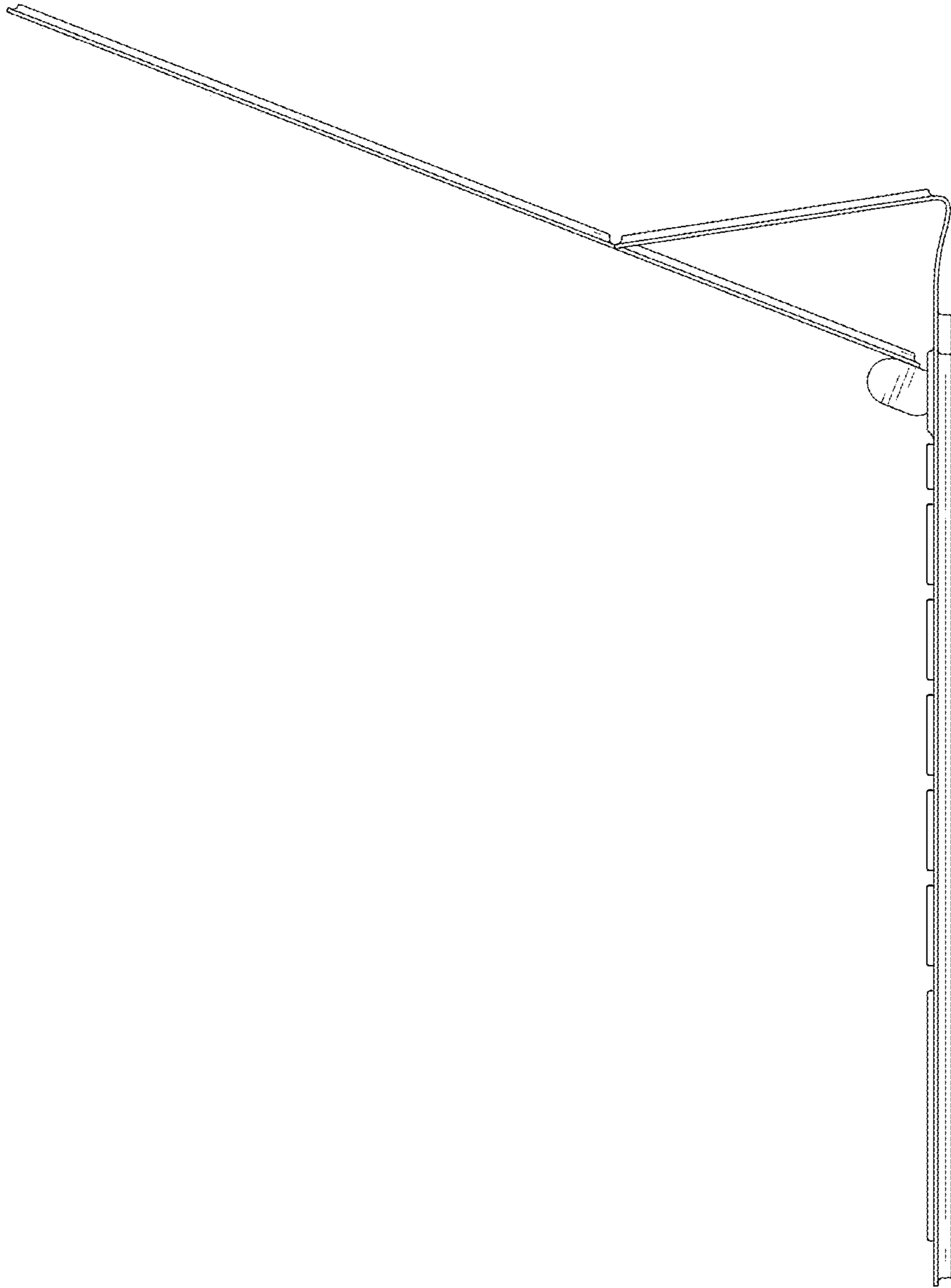

FIG. 28

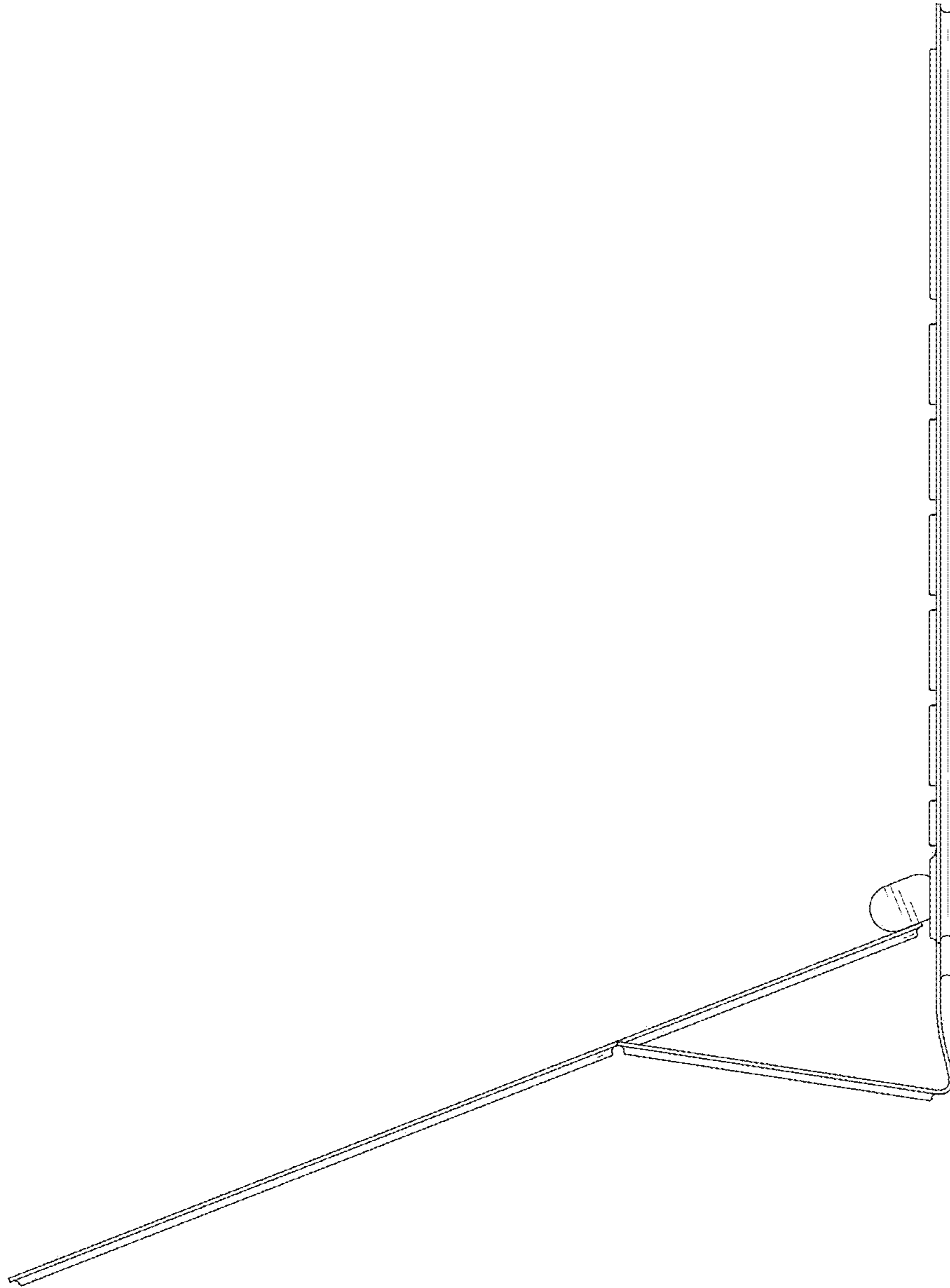

FIG. 29

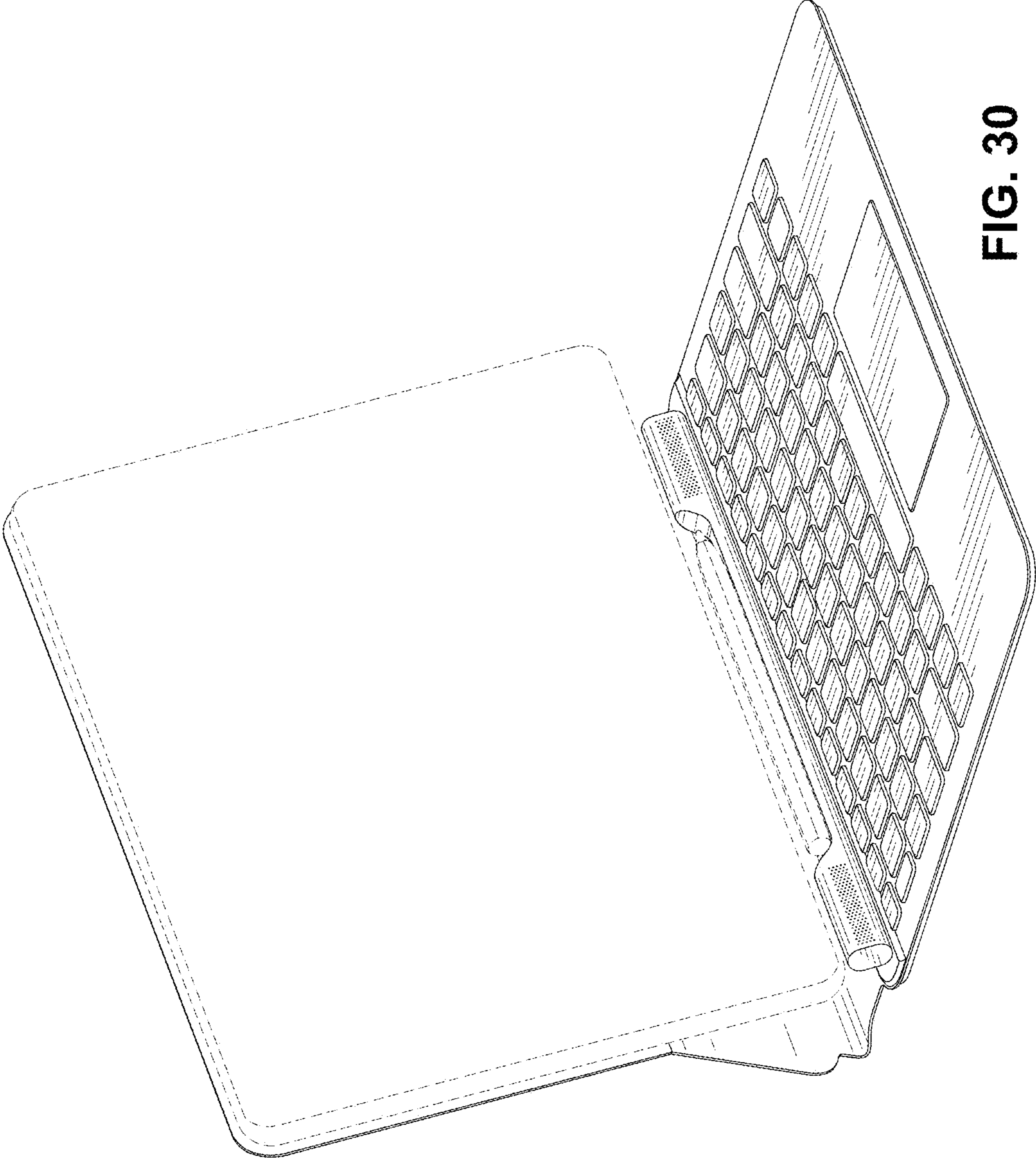

FIG. 30

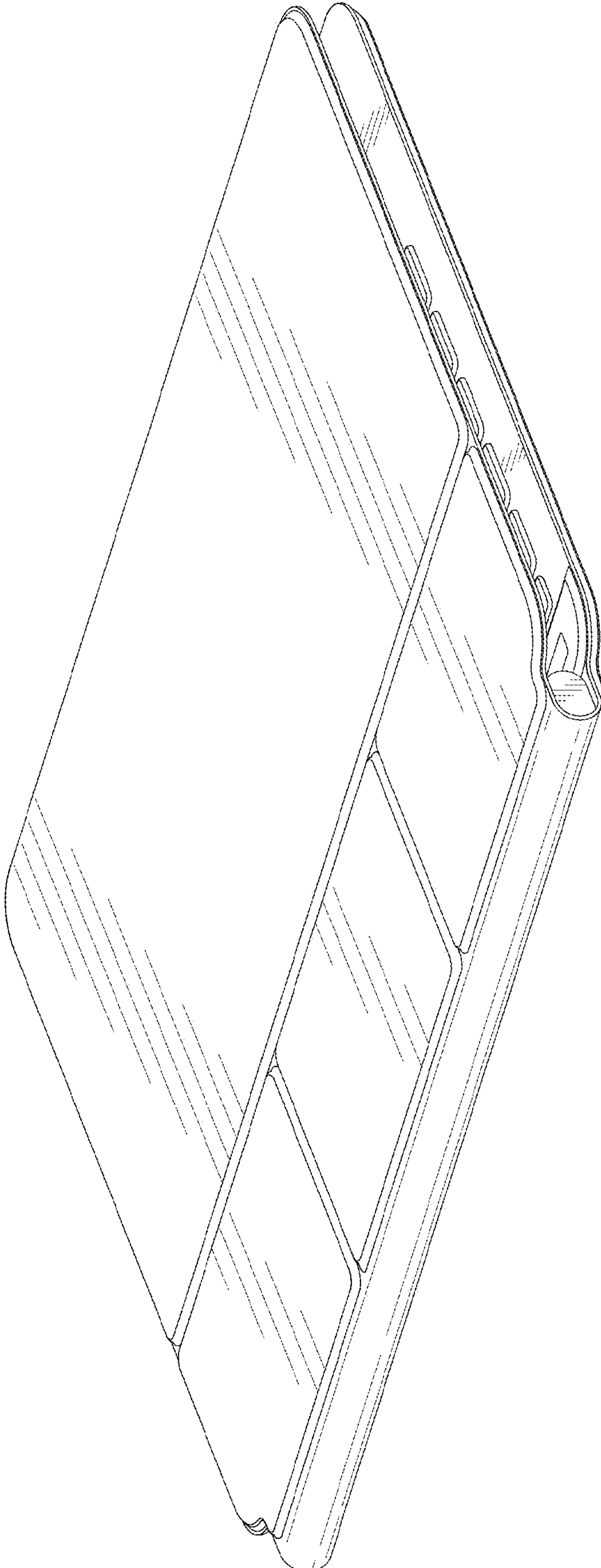

FIG. 31

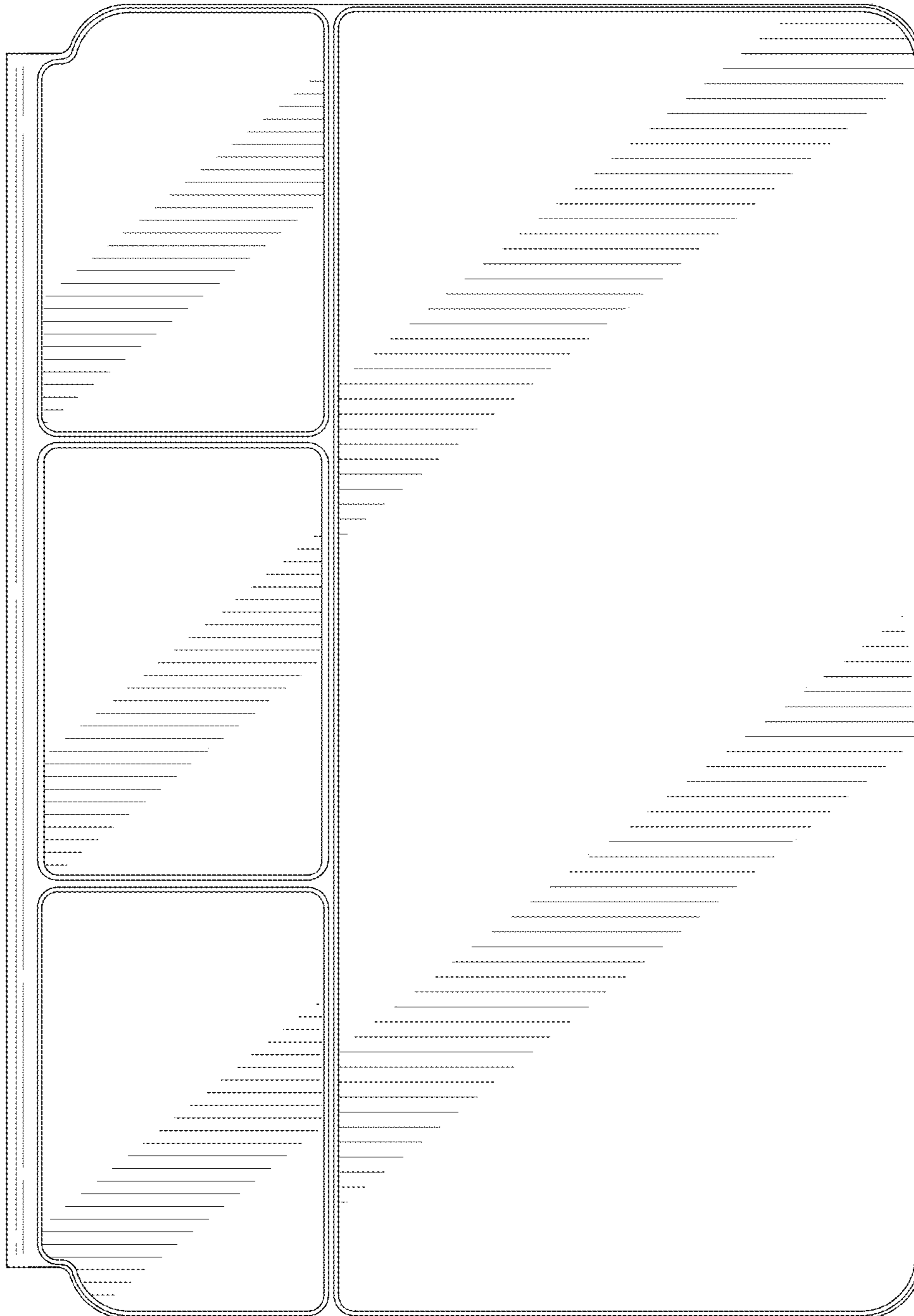

FIG. 32

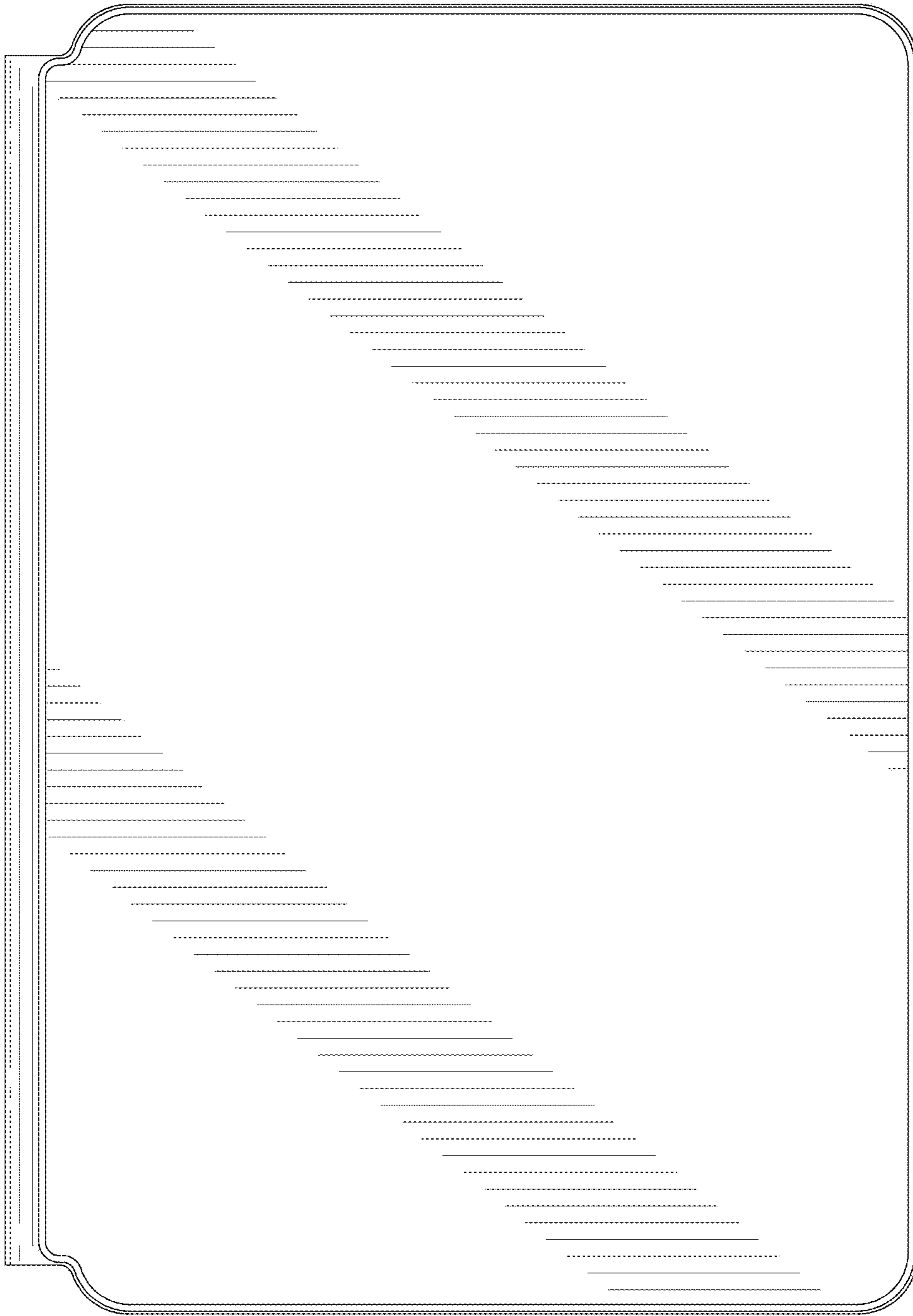

FIG. 33

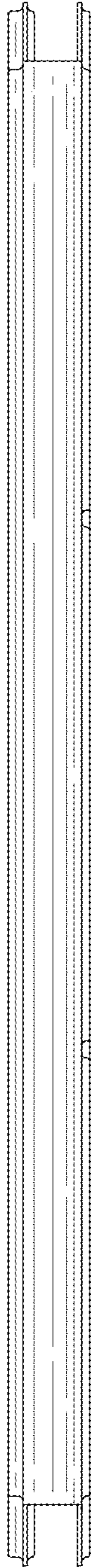

FIG. 34

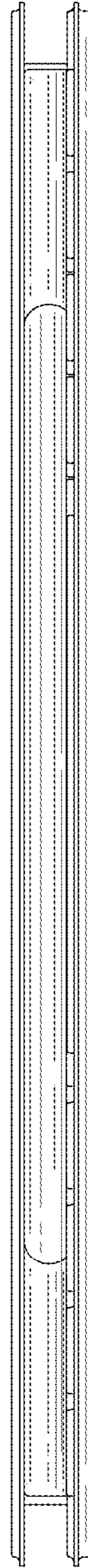

FIG. 35

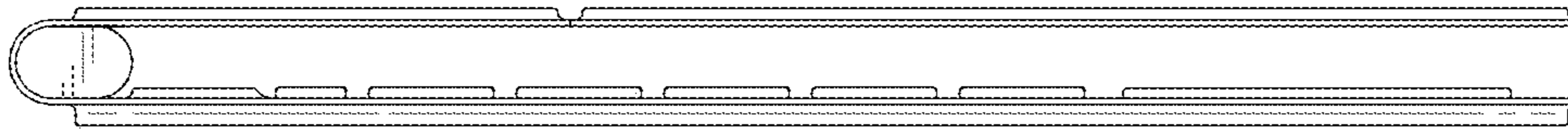

FIG. 37

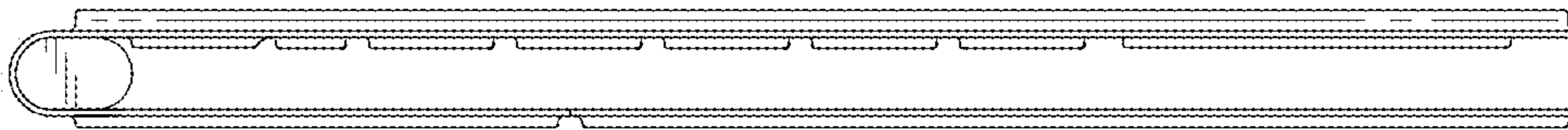

FIG. 36

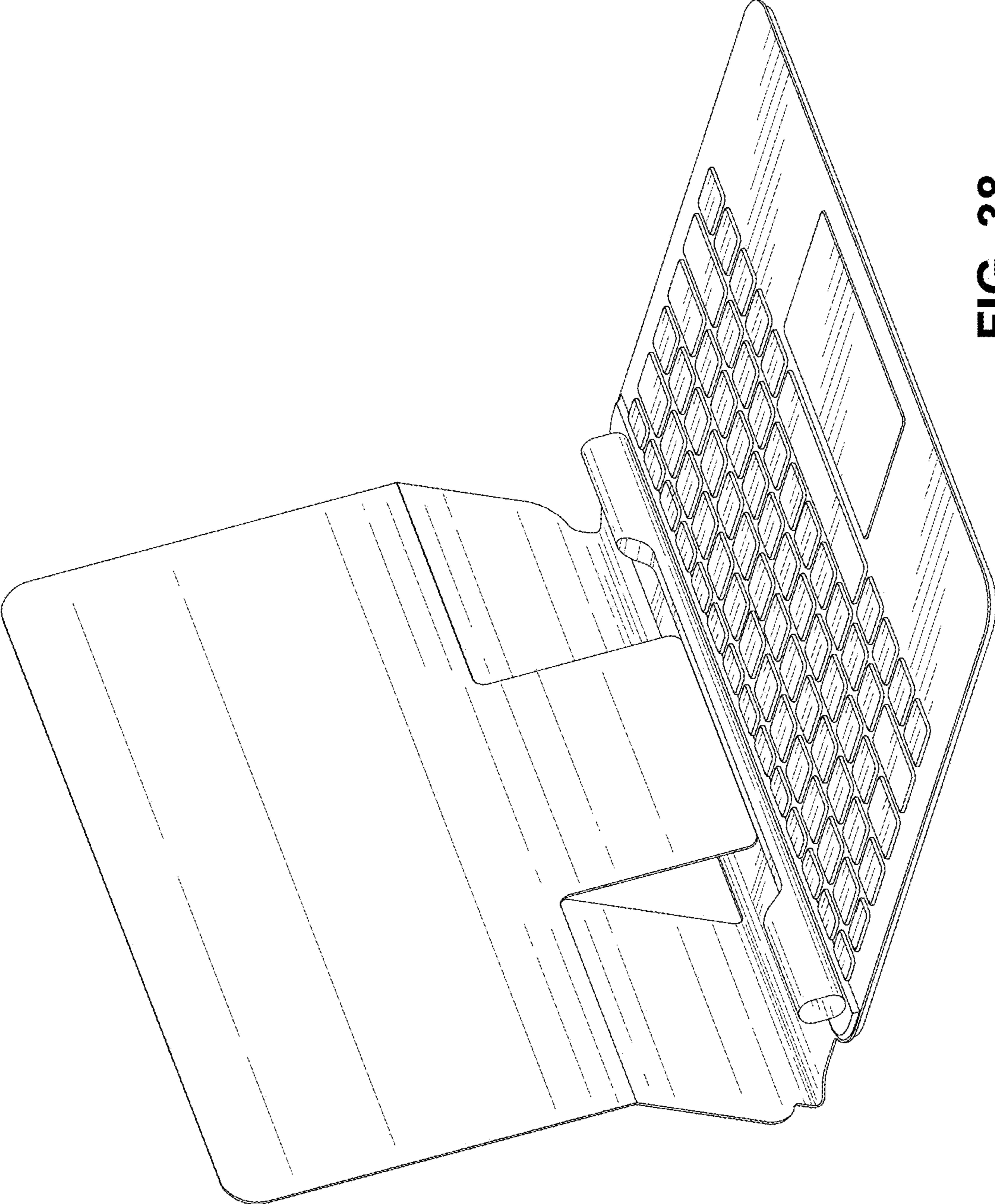

FIG. 38

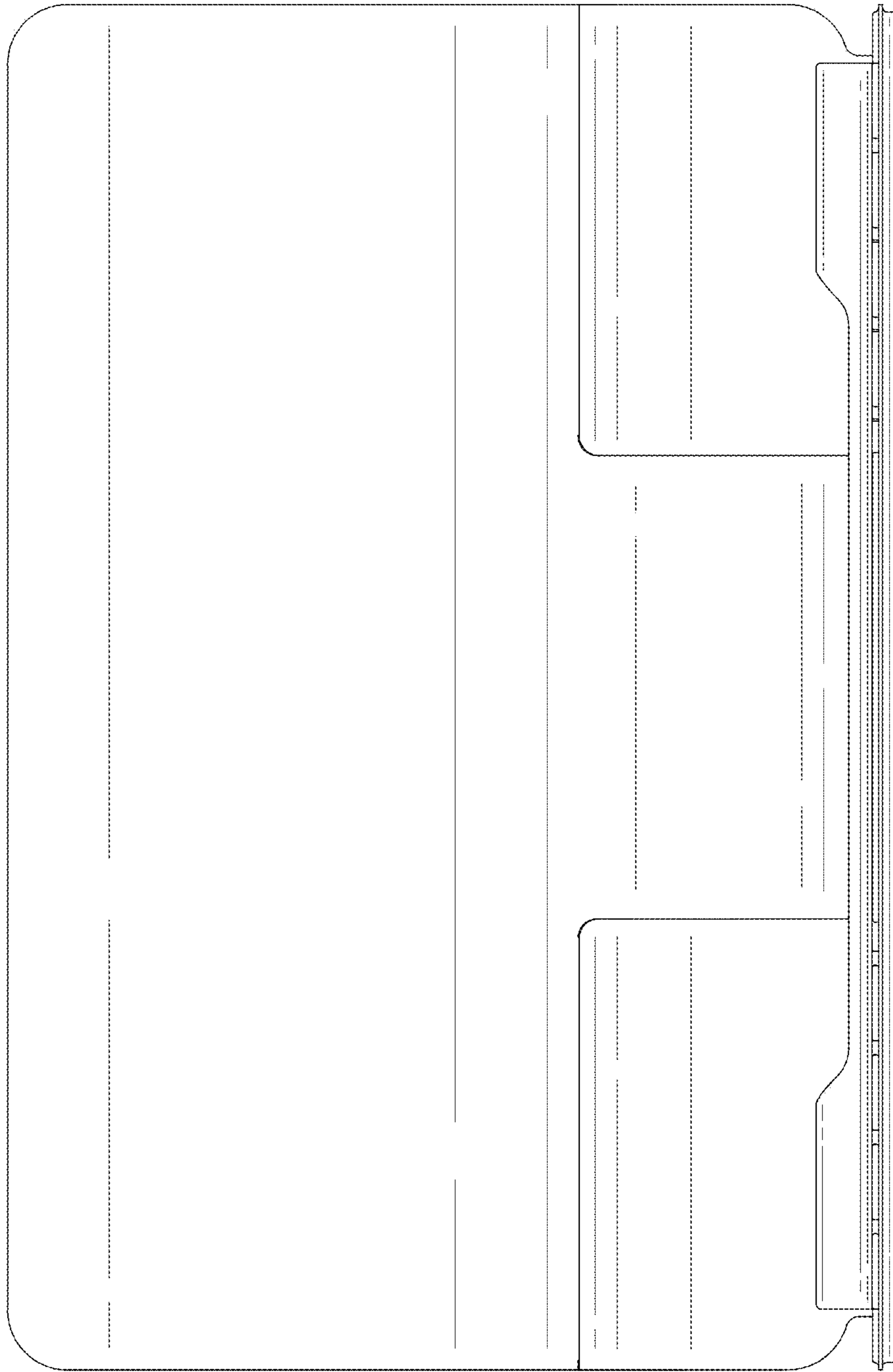

FIG. 39

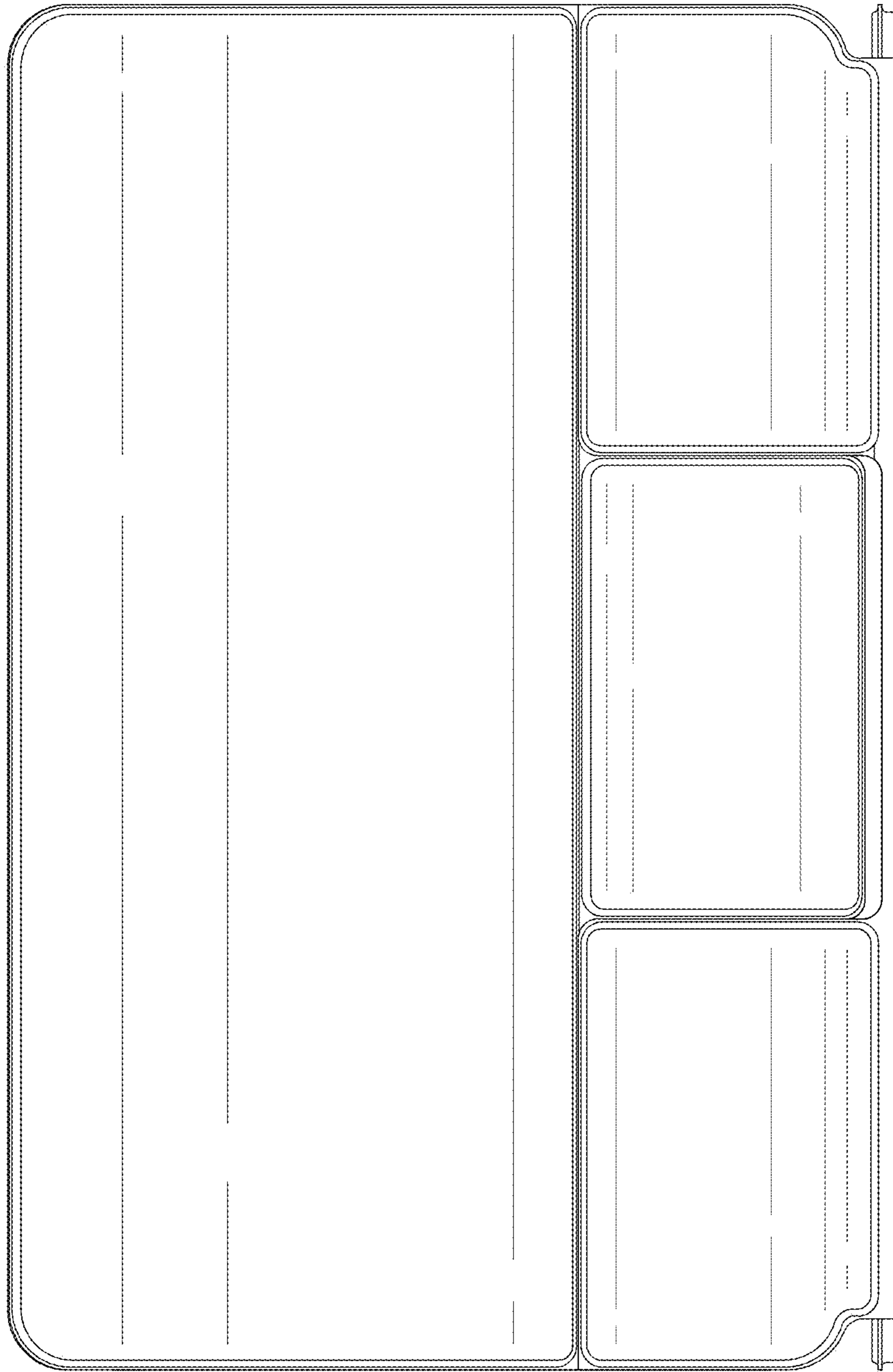

FIG. 40

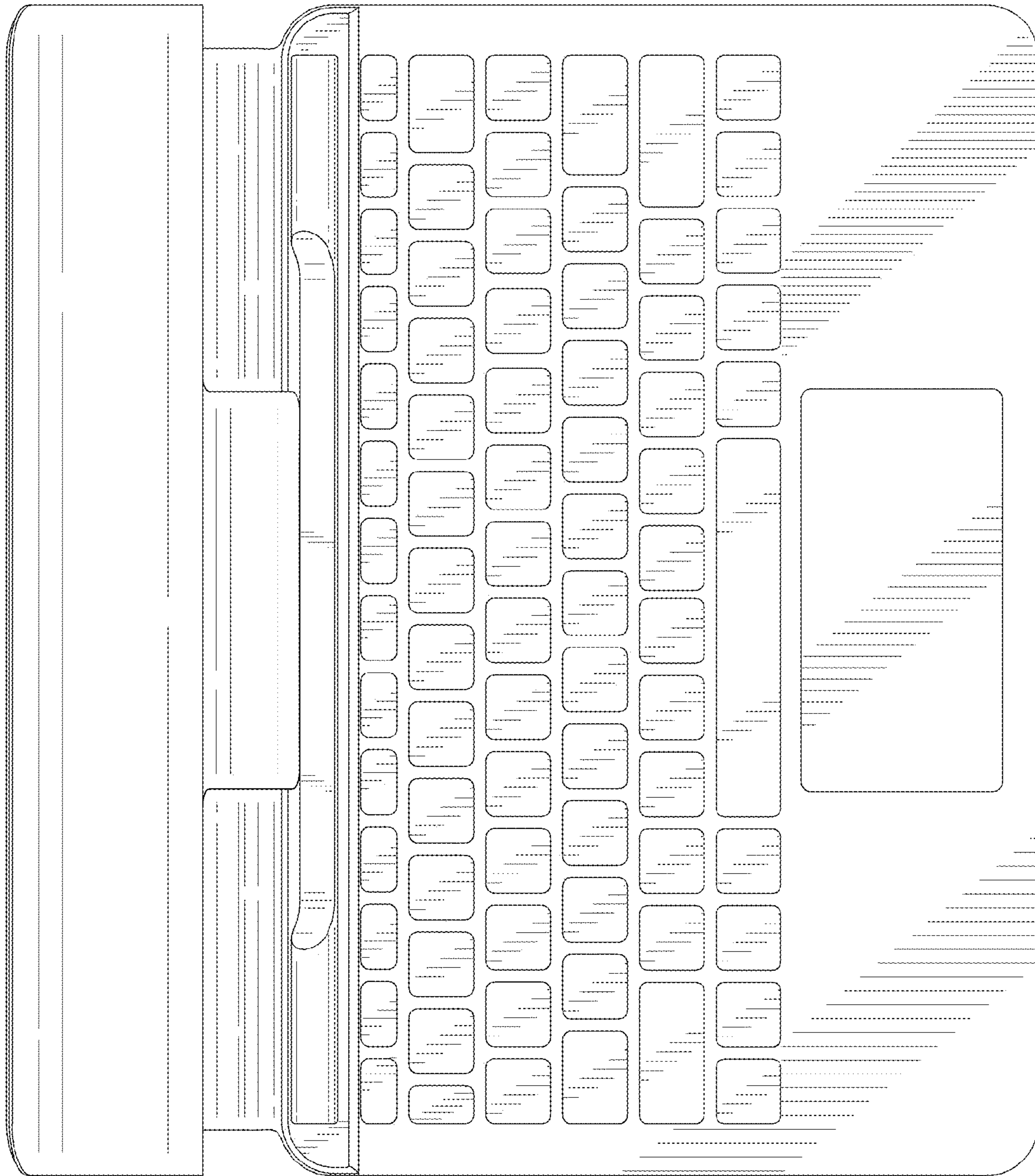

FIG. 41

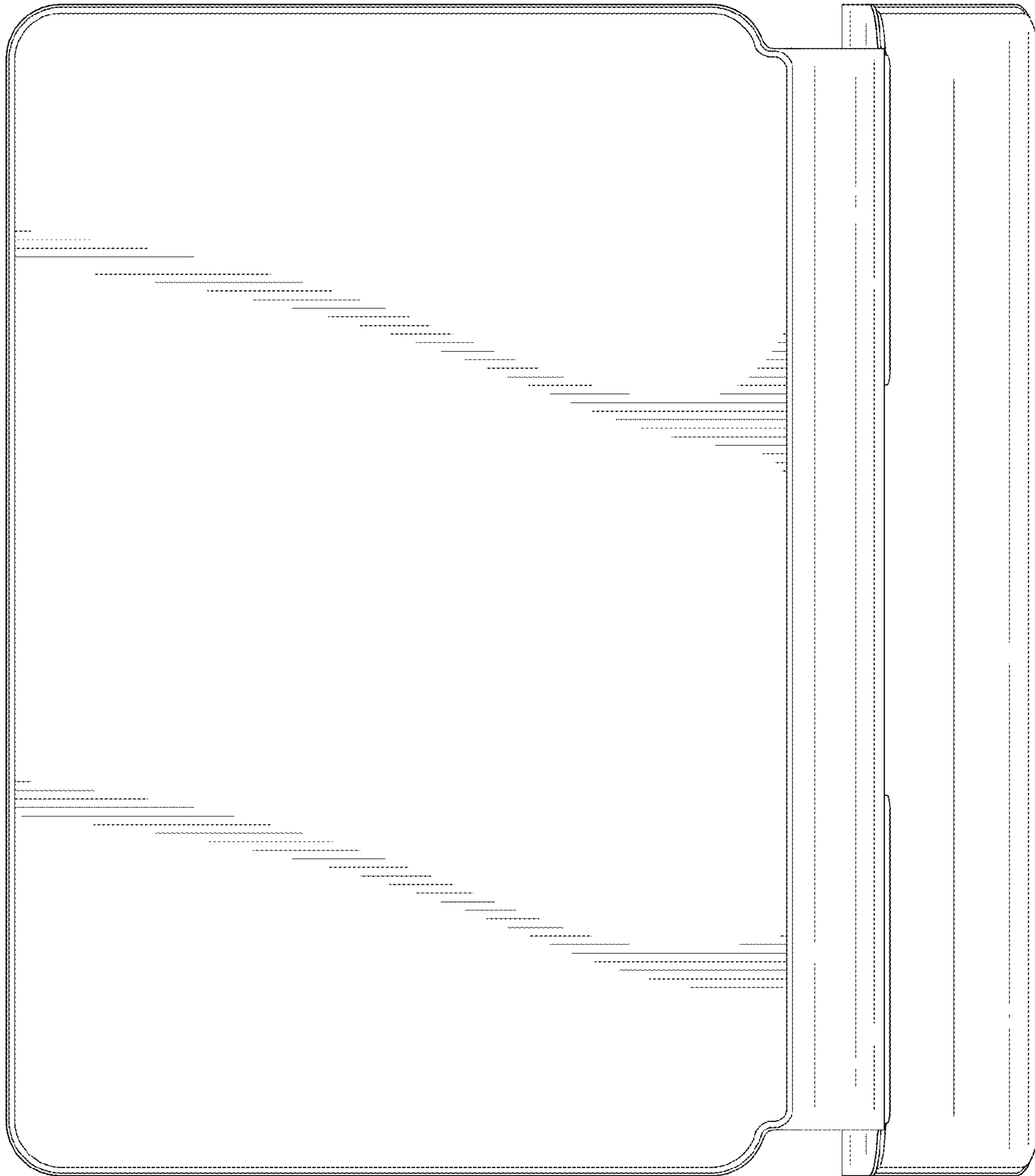

FIG. 42

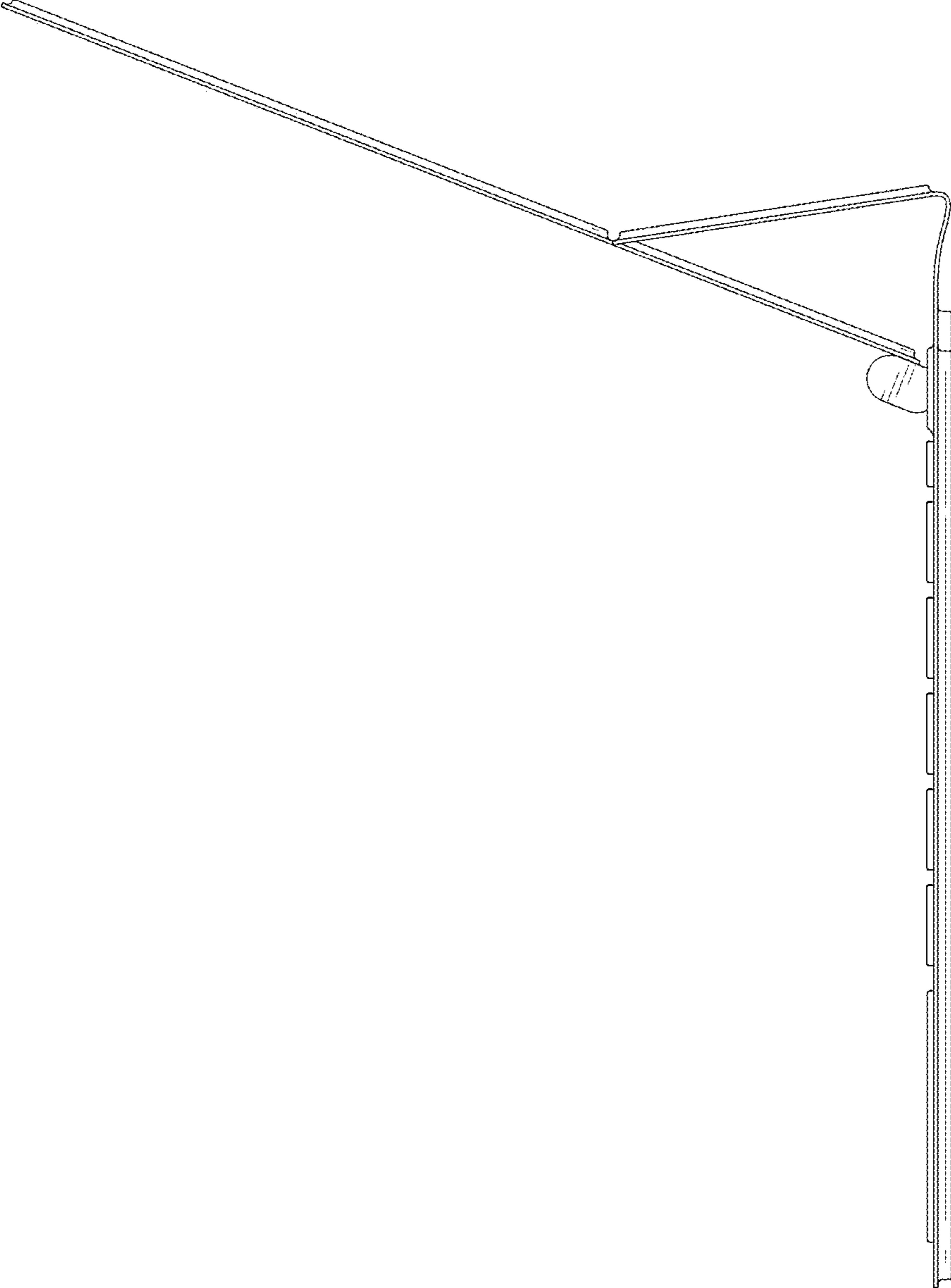

FIG. 43

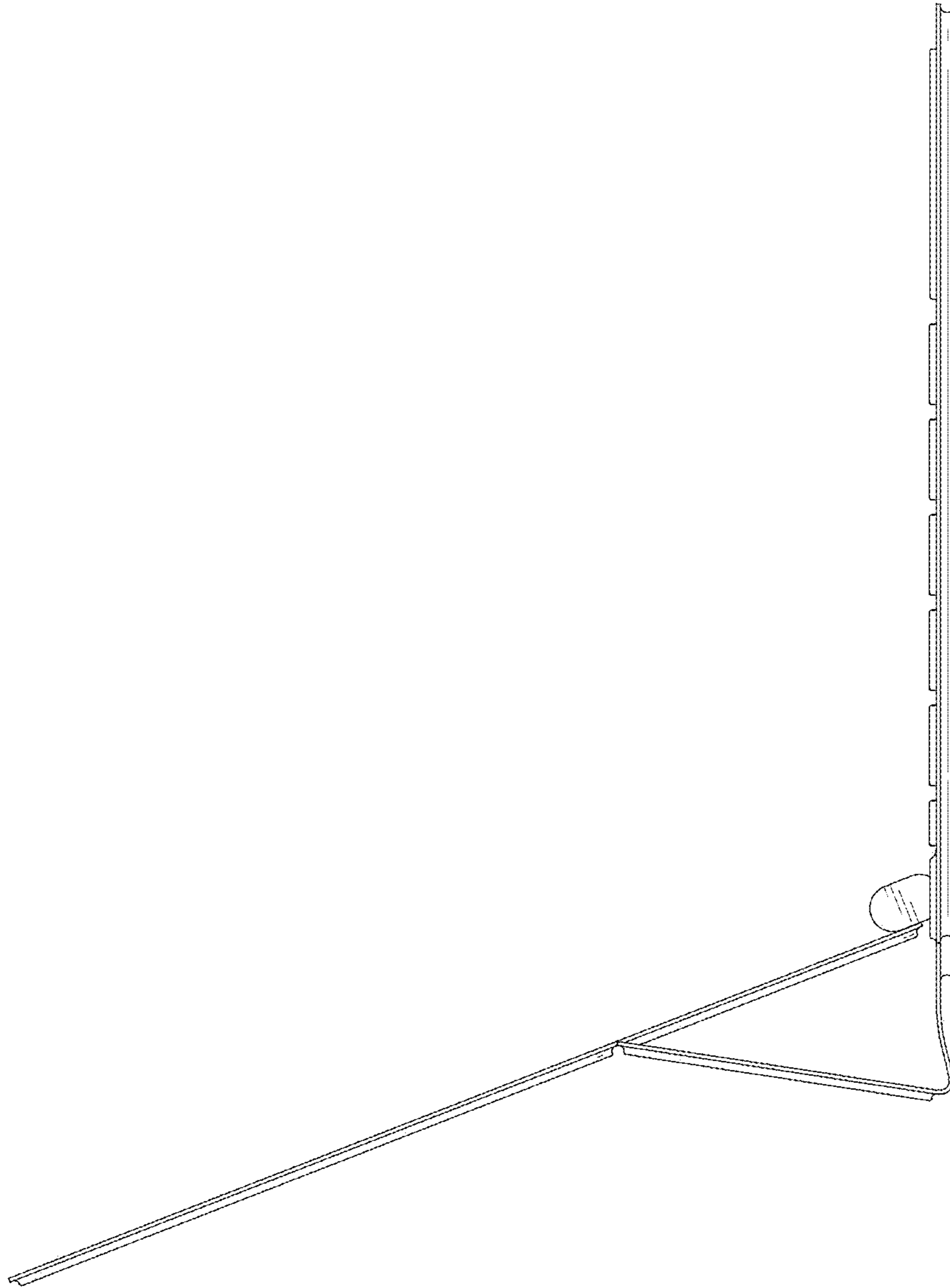

FIG. 44

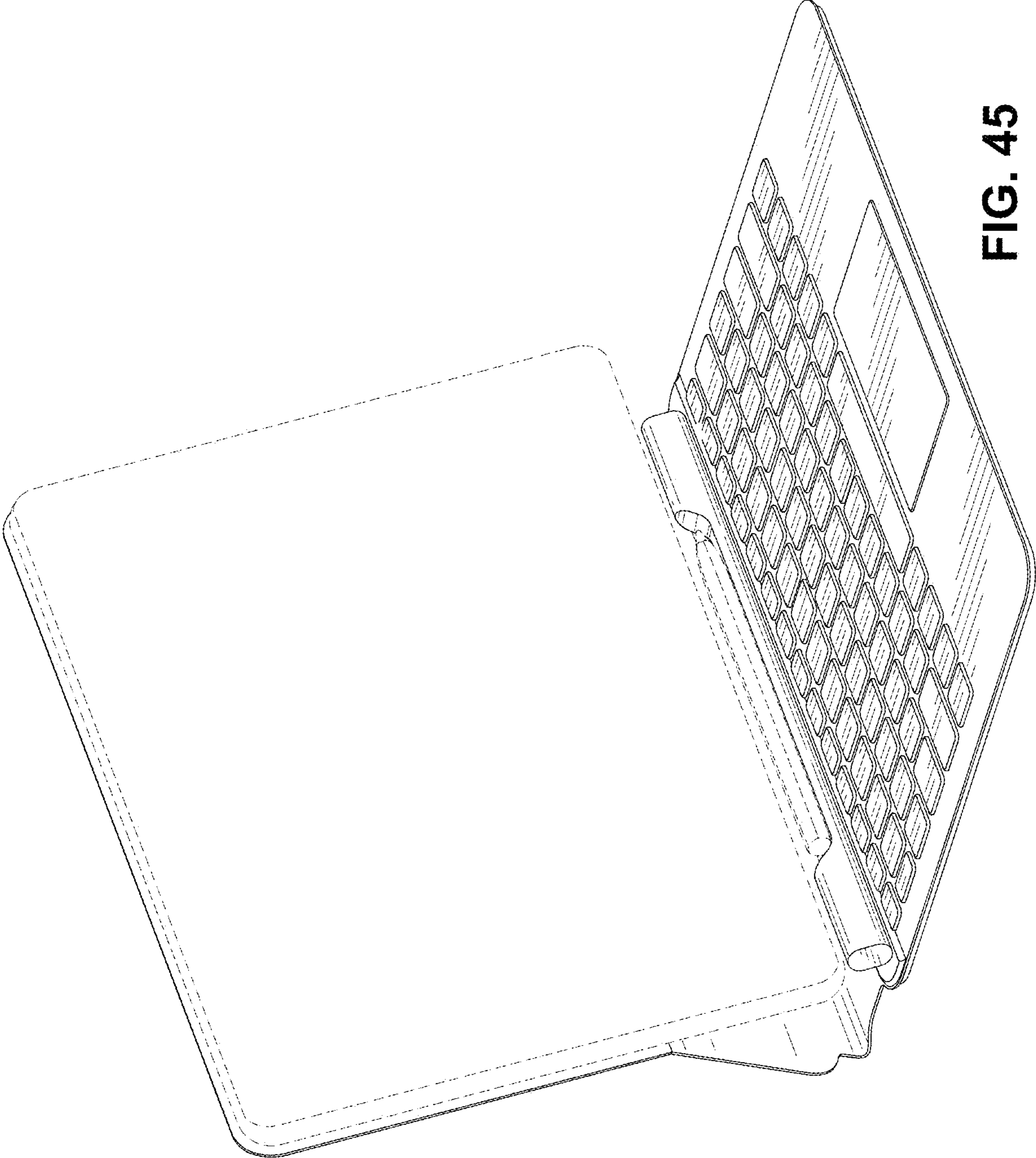

FIG. 45