



US00D987636S

(12) **United States Design Patent** (10) **Patent No.:** **US D987,636 S**
Morris (45) **Date of Patent:** **** May 30, 2023**

(54) **STYLUS**
 (71) Applicant: **Kent Displays, Inc.**, Kent, OH (US)
 (72) Inventor: **Hunter Morris**, Kent, OH (US)
 (73) Assignee: **Kent Displays, Inc.**, Kent, OH (US)
 (**) Term: **15 Years**
 (21) Appl. No.: **35/002,202**
 (22) Filed: **Dec. 23, 2021**

D921,630 S * 6/2021 Liu D14/411
 D936,652 S * 11/2021 Cen D14/411
 D936,655 S * 11/2021 Wu D14/411
 D941,292 S * 1/2022 Kanno D14/411
 D941,293 S * 1/2022 Zhao D14/411
 D943,583 S * 2/2022 Mo D14/411
 D944,799 S * 3/2022 Huang D14/411
 D947,193 S * 3/2022 Tang D14/411
 D951,947 S * 5/2022 Jin D14/411
 D956,050 S * 6/2022 Liu D14/411
 D967,102 S * 10/2022 Lee D14/411
 D970,505 S * 11/2022 Cai D14/411
 D972,562 S * 12/2022 Wu D14/411

* cited by examiner

(80) **Hague Agreement Data**
 Int. Filing Date: **Dec. 23, 2021**
 Int. Reg. No.: **DM/219780**
 Int. Reg. Date: **Dec. 23, 2021**
 Int. Reg. Pub. Date: **Jun. 24, 2022**

Primary Examiner — Austin Murphy
 (74) *Attorney, Agent, or Firm* — Serbinowski PLLC

(51) **LOC (14) Cl.** **14-02**
 (52) **U.S. Cl.**
 USPC **D14/411**

(57) **CLAIM**

The ornamental design for a stylus, as shown and described.

(58) **Field of Classification Search**
 USPC D14/372, 496, 432, 371, 125, 126, 129,
 D14/299, 411; D16/300–342; 351/158,
 351/153, 144; 345/7–9, 905; 455/344;
 348/115, 53, 121, 739
 CPC G02B 27/017; G06F 3/016; G06F 3/033;
 G06F 3/0317; G06F 3/03545; G06F
 3/041; G06K 9/222
 See application file for complete search history.

DESCRIPTION

- 1. Stylus
- 1.1 : Back Perspective
- 1.2 : Front Perspective
- 1.3 : Back
- 1.4 : Left
- 1.5 : Front
- 1.6 : Right
- 1.7 : Top
- 1.8 : Bottom

A stylus of which the following is a specification, reference being made to the accompanying drawings, forming a part hereof.

(56) **References Cited**
 U.S. PATENT DOCUMENTS

D921,628 S * 6/2021 Huang D14/411
 D921,629 S * 6/2021 Liu D14/411

1 Claim, 8 Drawing Sheets

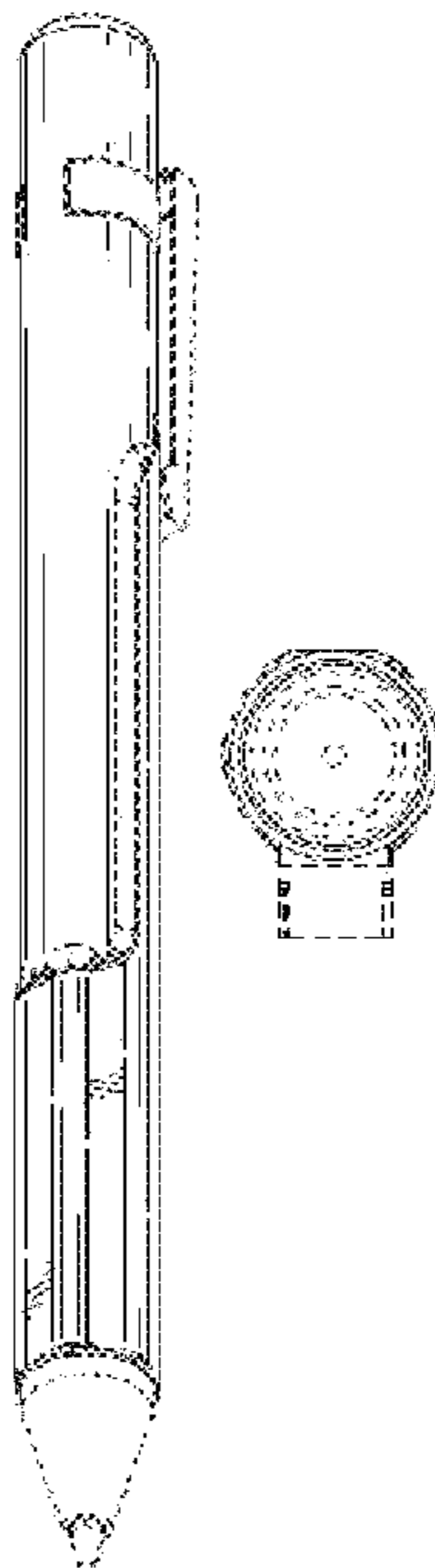

1.1

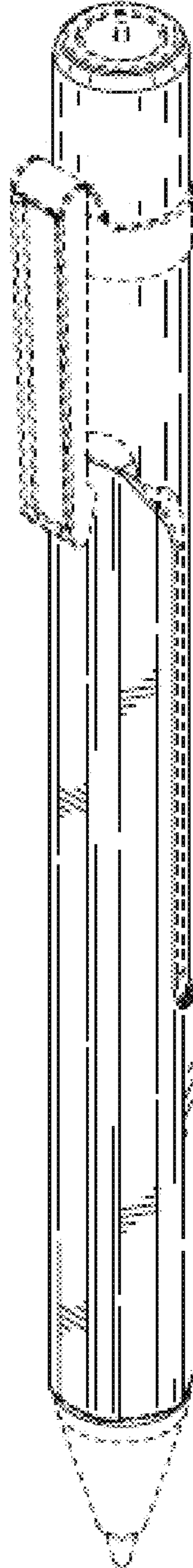

1.2

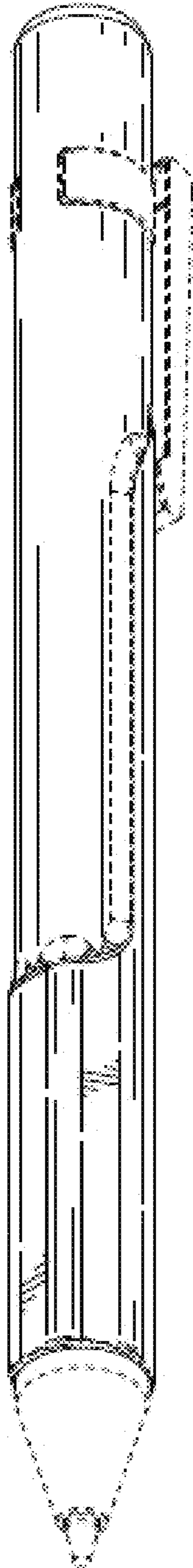

1.3

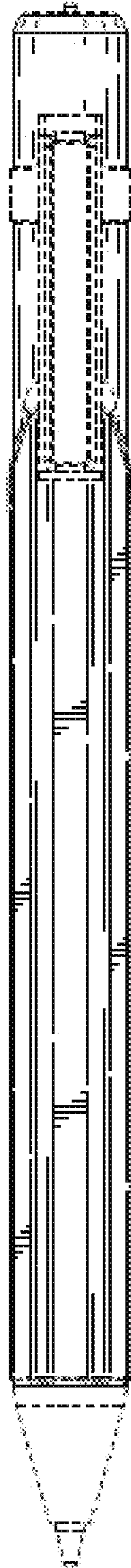

1.4

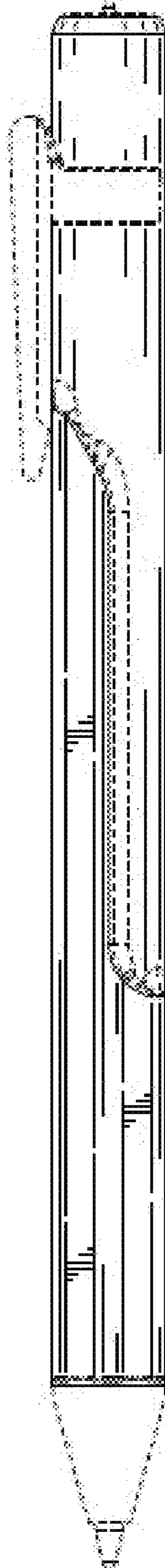

1.5

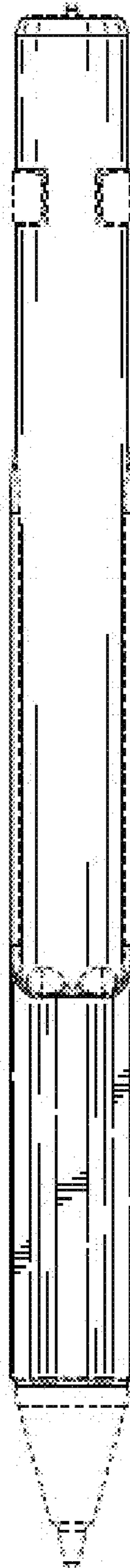

1.6

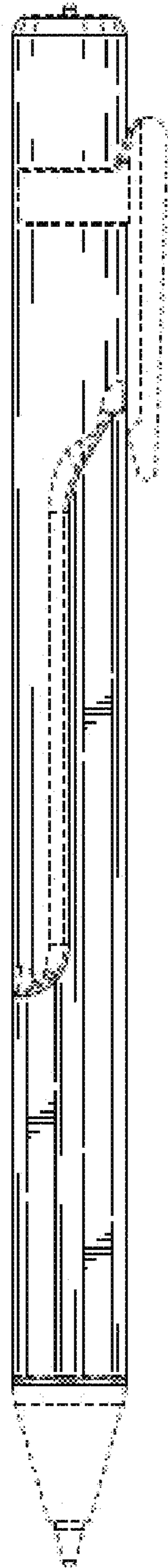

1.7

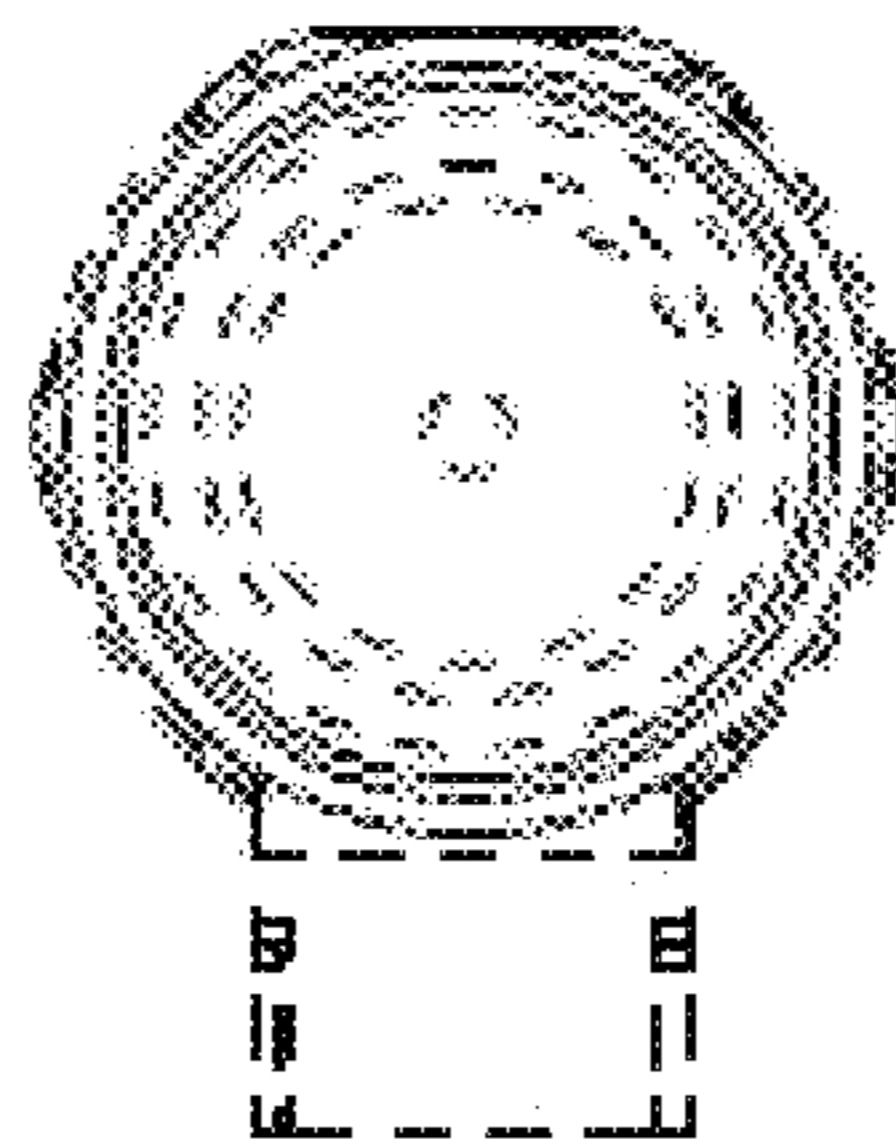

1.8

