



US00D987631S

(12) **United States Design Patent**
Stone et al.

(10) **Patent No.:** **US D987,631 S**

(45) **Date of Patent:** **** May 30, 2023**

(54) **REMOTE TRAINING PLATFORM HEADSET**

(71) Applicant: **Viomerse, Inc.**, Pittsford, NY (US)

(72) Inventors: **Jonathan Stone**, Rochester, NY (US);
Nelson Stone, Vail, CO (US); **Steven Griffith**, Honeoye Falls, NY (US)

(73) Assignee: **Viomerse, Inc.**, Pittsford, NY (US)

(**) Term: **15 Years**

(21) Appl. No.: **29/868,753**

(22) Filed: **Dec. 13, 2022**

(51) **LOC (14) Cl.** **14-02**

(52) **U.S. Cl.**
USPC **D14/372**

(58) **Field of Classification Search**
USPC D14/372, 496, 432, 371, 125, 126, 129,
D14/299; D16/300-342; 351/158, 153,
351/144; 345/7-9, 905; 455/344;
348/115, 53, 121, 739
CPC G02B 27/017; G02B 27/0158; G02B
27/0161; G02B 27/0181; G02B 27/0185;
G02B 27/0189
See application file for complete search history.

(56) **References Cited**

U.S. PATENT DOCUMENTS

D363,482 S * 10/1995 Robinson D14/372
D383,455 S * 9/1997 MacInnes D14/372

D390,552 S * 2/1998 Ronzani D14/372
D645,862 S * 9/2011 Paul D14/372
D778,909 S * 2/2017 Nokuo D14/372
D813,232 S * 3/2018 Clement D14/372
D839,269 S * 1/2019 Wang D14/372
D972,735 S * 12/2022 Keller D24/186

* cited by examiner

Primary Examiner — Austin Murphy

(74) *Attorney, Agent, or Firm* — Woods Oviatt Gilman
LLP; Katherine H. McGuire, Esq.

(57) **CLAIM**

The ornamental design for the remote training platform headset, as shown and described.

DESCRIPTION

FIG. 1 is a front perspective view of the remote training platform headset;
FIG. 2 is a front elevational view thereof;
FIG. 3 is a rear elevational view thereof;
FIG. 4 is a left side elevational view thereof;
FIG. 5 is a right side elevational view thereof;
FIG. 6 is a top plan view thereof; and,
FIG. 7 is a bottom plan view thereof.

The broken lines are for the purpose of illustrating environmental structure and forms no part of the claimed design.

1 Claim, 7 Drawing Sheets

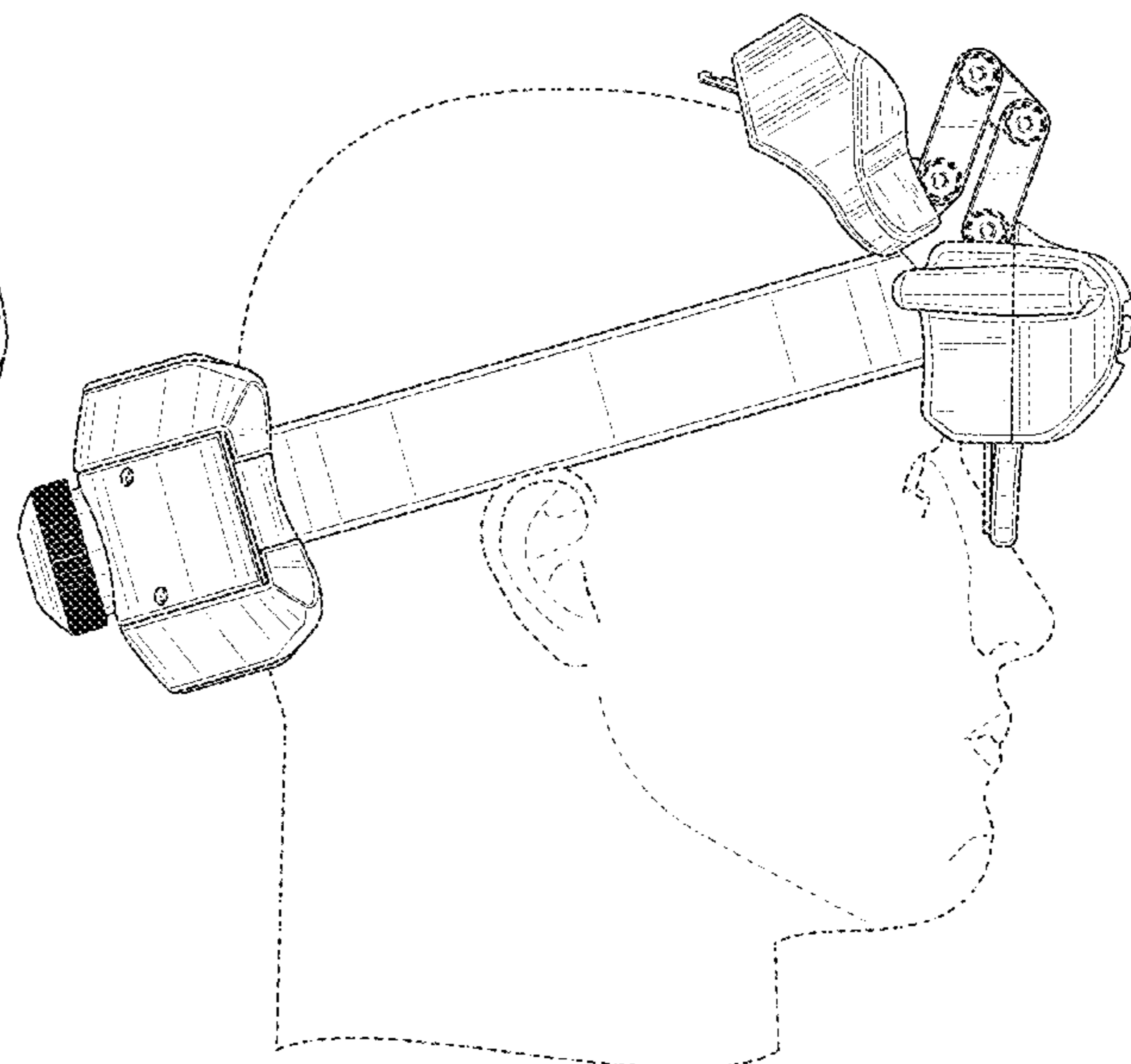
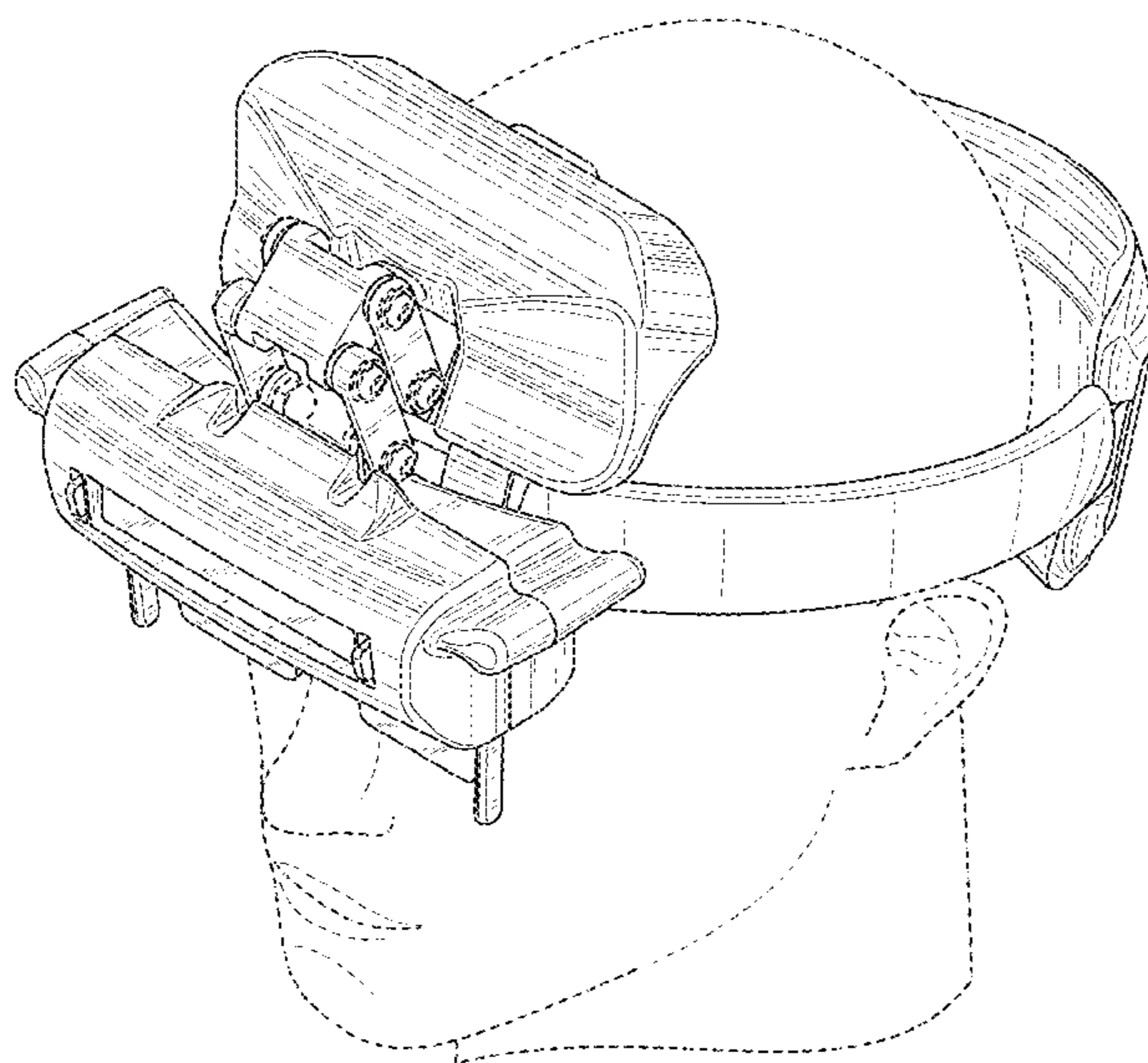

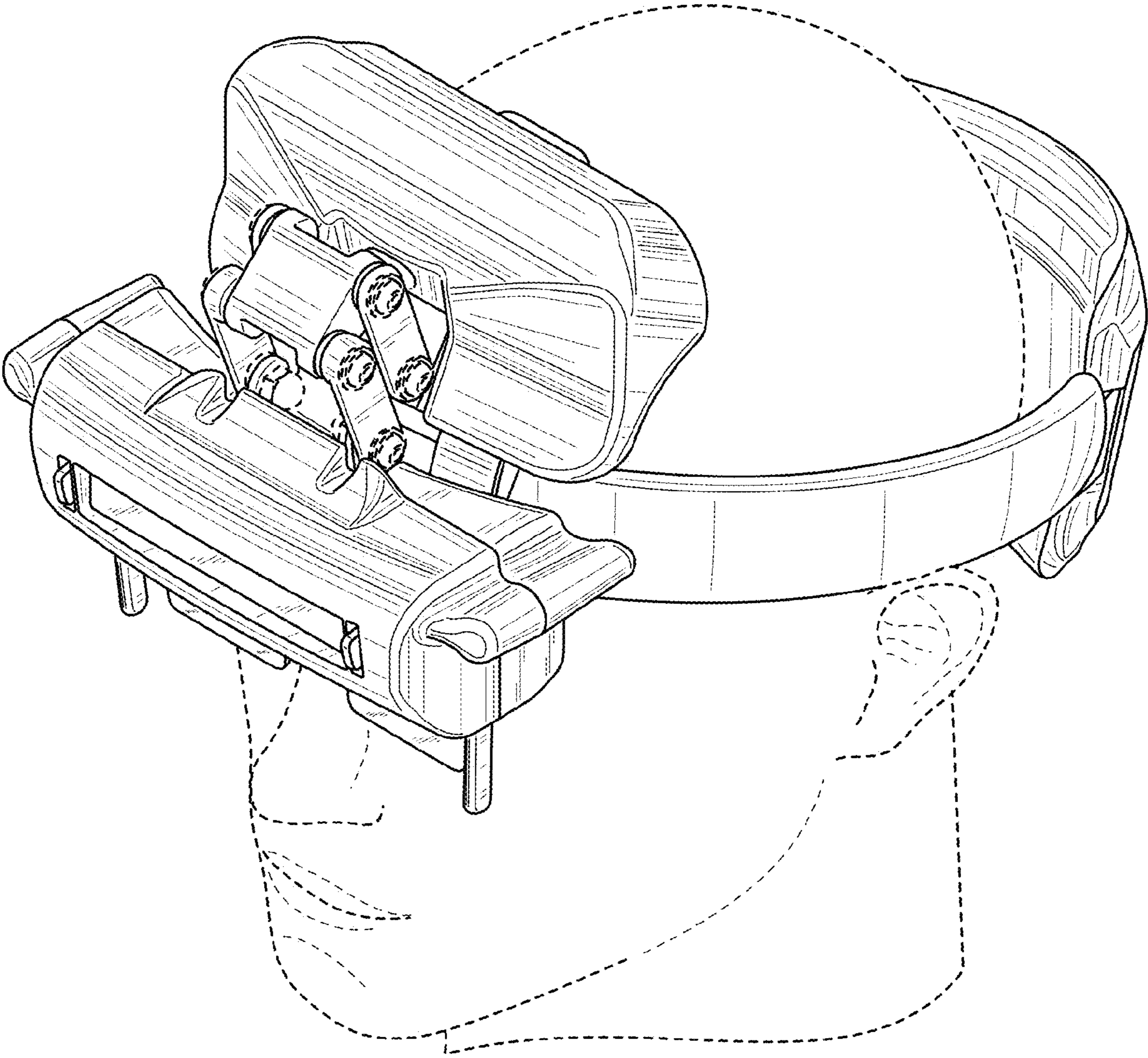

FIG. 1

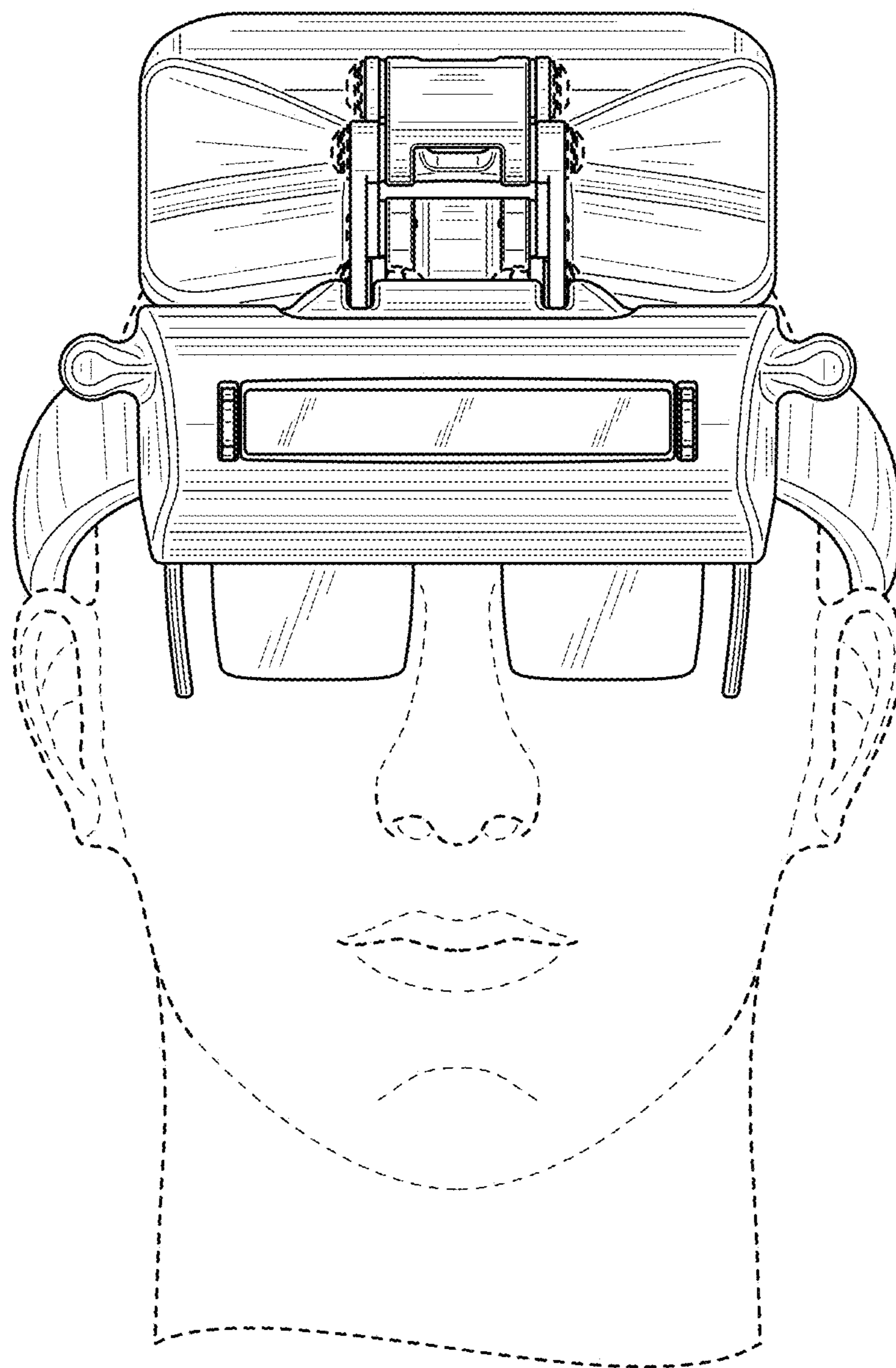

FIG. 2

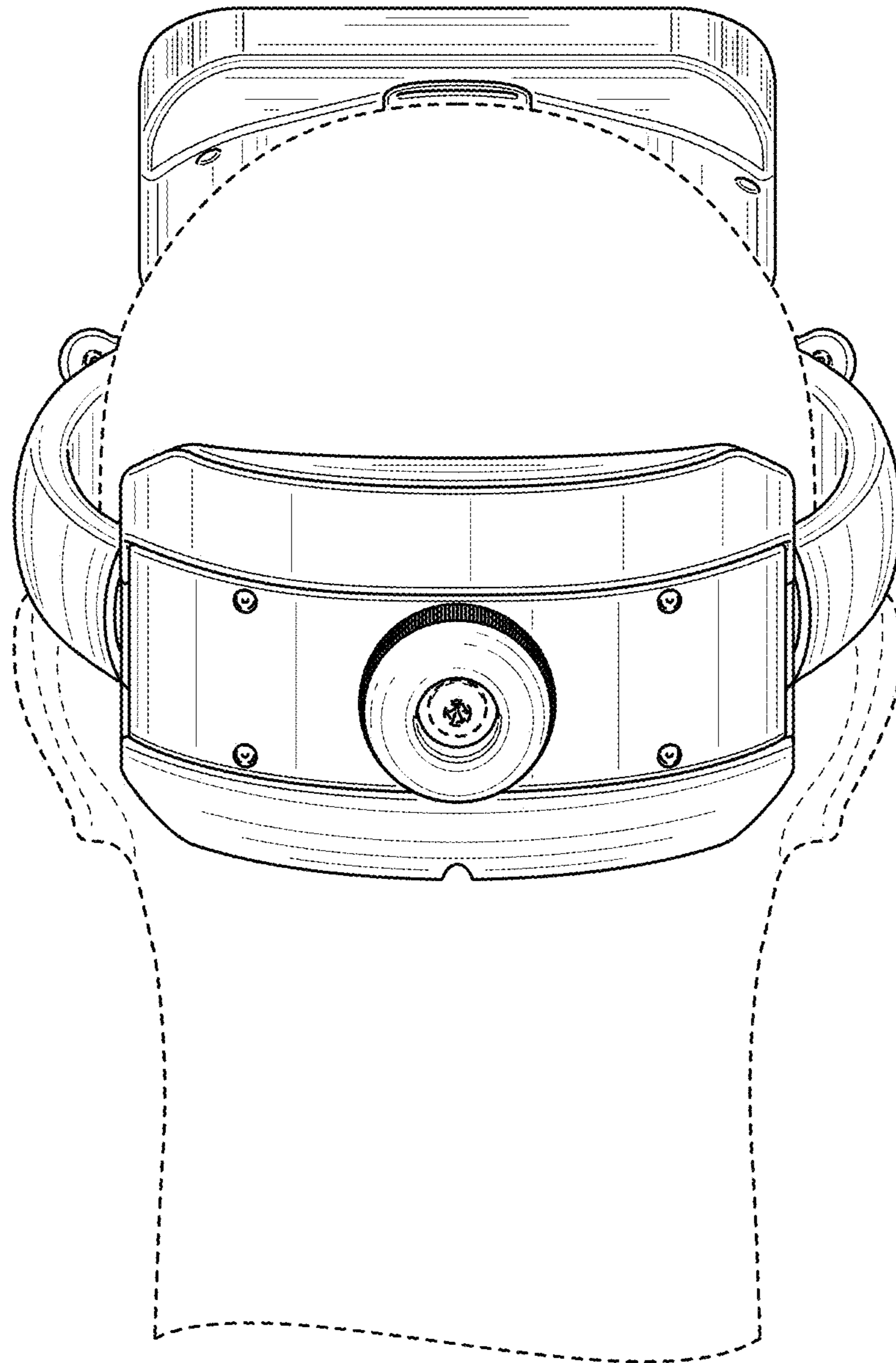

FIG. 3

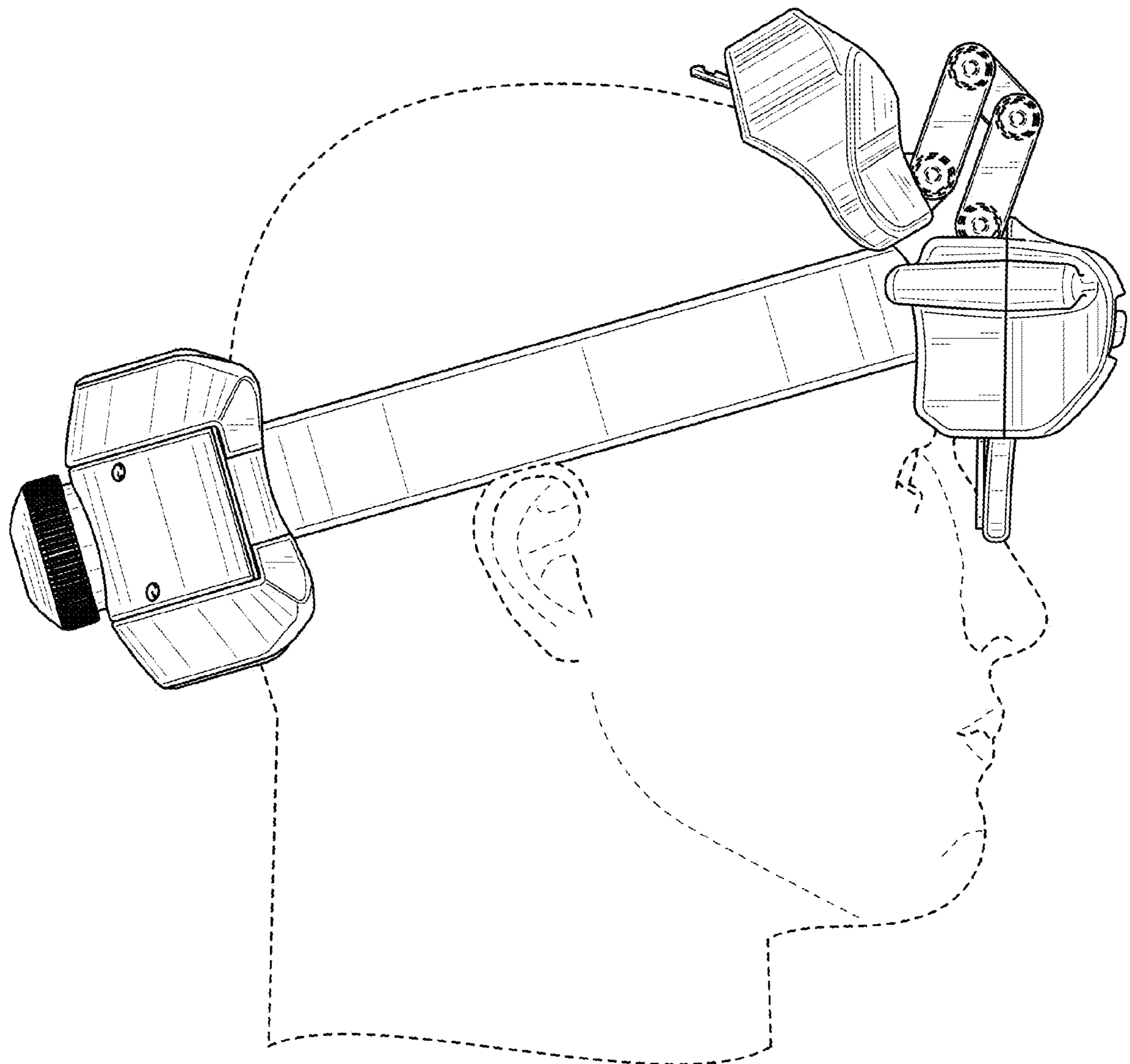

FIG. 4

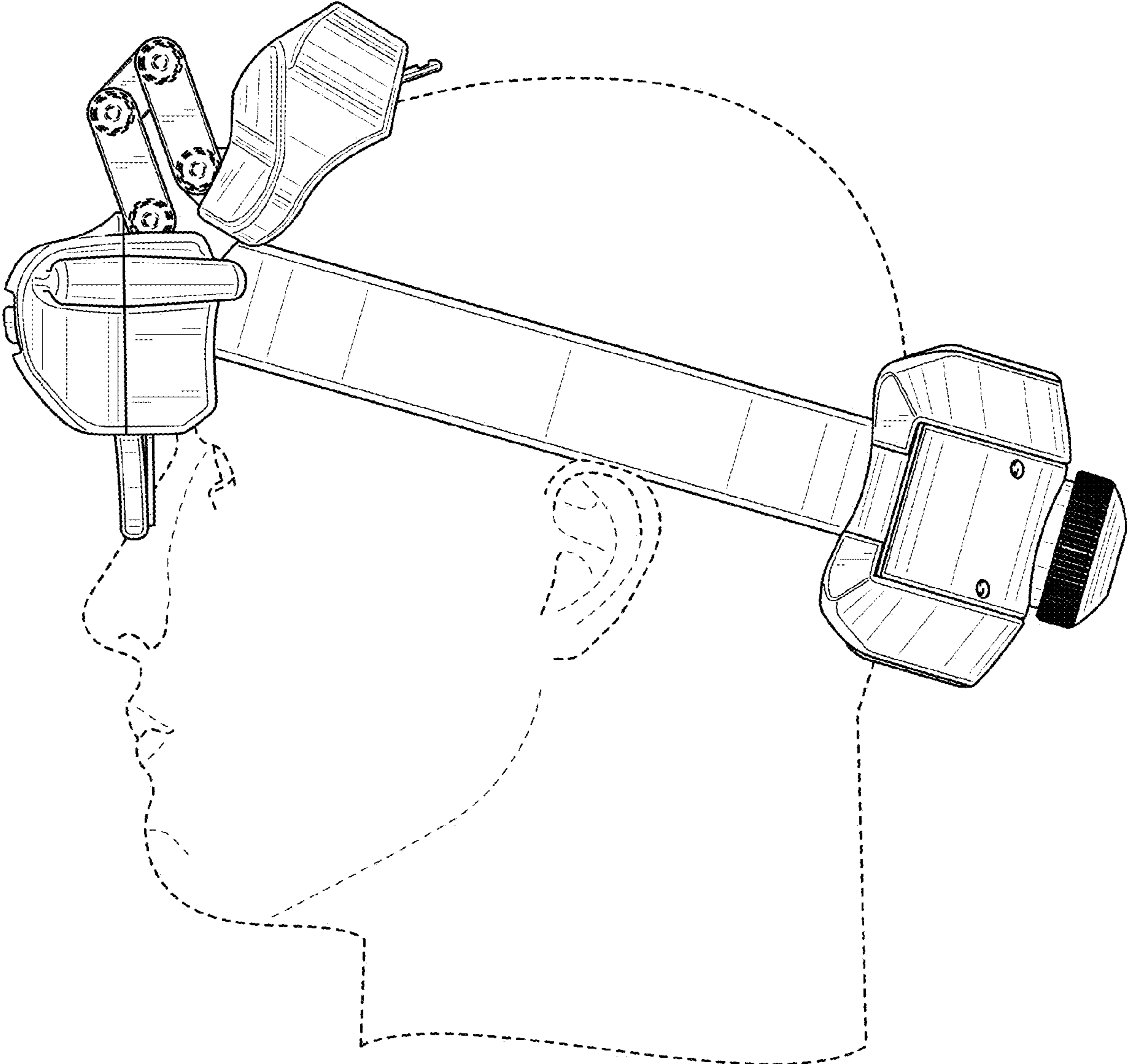

FIG. 5

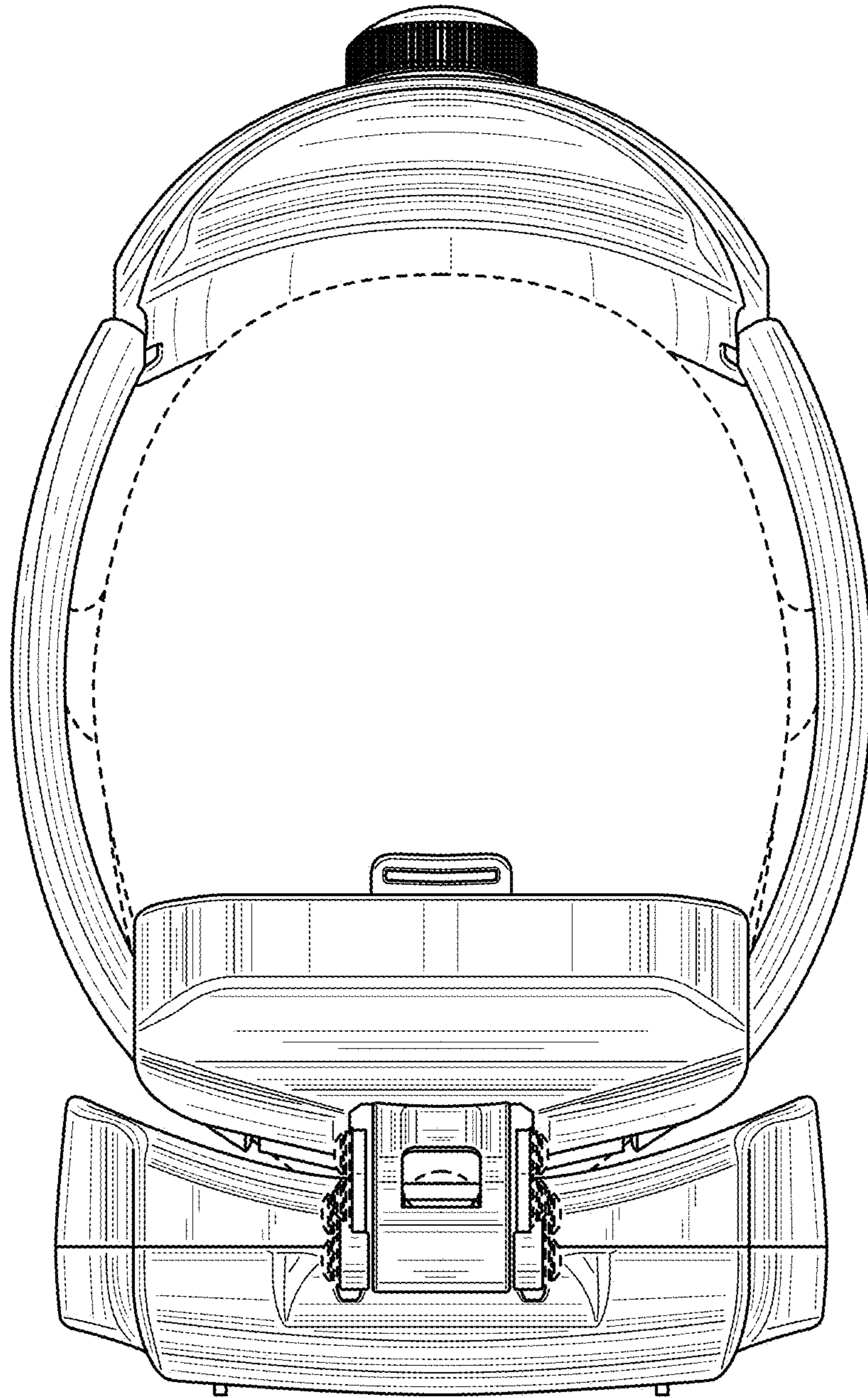

FIG. 6

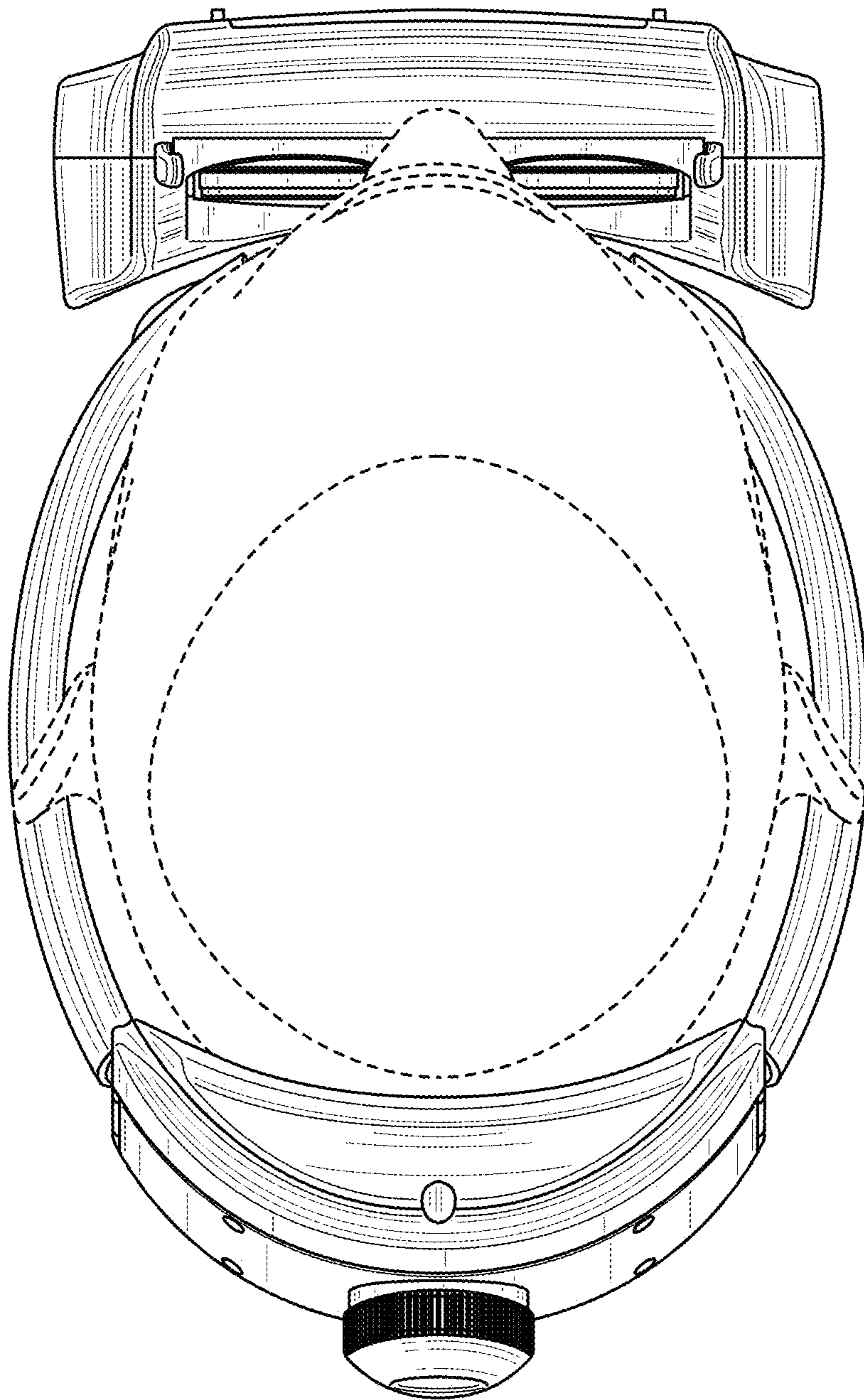

FIG. 7