



US00D987613S

(12) **United States Design Patent**
Myung et al.

(10) **Patent No.:** **US D987,613 S**
(45) **Date of Patent:** **** May 30, 2023**

(54) **CASE FOR PORTABLE ELECTRONIC DEVICE**

(71) Applicant: **Samsung Electronics Co., Ltd.**,
Suwon-si (KR)

(72) Inventors: **Jieun Myung**, Suwon-si (KR); **Dahyun Lee**, Suwon-si (KR); **Junho Jin**, Suwon-si (KR); **Bosoon Kang**, Suwon-si (KR); **Jinhoo Lee**, Suwon-si (KR); **Junwon Lee**, Suwon-si (KR); **Namsu Kim**, Suwon-si (KR); **Jiyeon Lim**, Suwon-si (KR); **Kangmoon Kim**, Suwon-si (KR)

(73) Assignee: **SAMSUNG ELECTRONICS CO., LTD.**, Suwon-si (KR)

(**) Term: **15 Years**

(21) Appl. No.: **29/812,286**

(22) Filed: **Oct. 20, 2021**

(30) **Foreign Application Priority Data**

Apr. 30, 2021 (KR) 30-2021-0021149

(51) **LOC (14) Cl.** **14-03**

(52) **U.S. Cl.**
USPC **D14/250**

(58) **Field of Classification Search**
USPC D13/107, 108; D14/217, 248, 250–253,
D14/426, 432, 434, 440, 447
CPC H04B 1/3888; H04M 1/0283; H04M
1/0202; A45F 2005/028; A45F 2200/0525
See application file for complete search history.

(56) **References Cited**

U.S. PATENT DOCUMENTS

D782,436 S * 3/2017 Kwak D14/345
D788,726 S * 6/2017 Lee D14/138 AB
10,064,298 B2 * 8/2018 Cavenagh H04M 1/022
D828,318 S * 9/2018 Seo D14/138 AD

D843,994 S * 3/2019 Jeong D14/250
D851,920 S * 6/2019 Mouriz D3/218
D851,921 S * 6/2019 Goetz D3/218
D862,081 S * 10/2019 Lange D3/249
D880,149 S * 4/2020 Yang D3/226
D891,101 S * 7/2020 Lv D3/249
D902,167 S * 11/2020 Lee D14/138 AB
D908,353 S * 1/2021 Peng D3/249

(Continued)

OTHER PUBLICATIONS

Samsung Galaxy Z Flip 3 Phone Case, Silicone Protective Cover with Ring, publication date Jun. 20, 2021, [online] URL: <https://www.amazon.com/Samsung-Electronics-Protective-Shockproof-EF-PF711TNEGUS/dp/B0977LVHY4/> (Year: 2021).*

Samsung Galaxy Z Flip 3 Phone Case, Aramid Protective Cover, publication date Aug. 11, 2021, [online] URL: <https://www.amazon.com/dp/B0977LWNC7/> (Year: 2021).*

(Continued)

Primary Examiner — L. A. Grabenstetter

(74) *Attorney, Agent, or Firm* — McAndrews Heid & Malloy, Ltd.

(57) **CLAIM**

The ornamental design for a case for portable electronic device, as shown and described.

DESCRIPTION

FIG. 1 is a front perspective view of a case for portable electronic device showing our new design;
FIG. 2 is a front view thereof;
FIG. 3 is a rear view thereof;
FIG. 4 is a left side view thereof;
FIG. 5 is a right side view thereof;
FIG. 6 is a top plan view thereof;
FIG. 7 is a bottom plan view thereof; and,
FIG. 8 is a rear perspective view thereof.
The dashed broken lines in the figures depict portions of the case for portable electronic device that form no part of the claimed design.

1 Claim, 6 Drawing Sheets

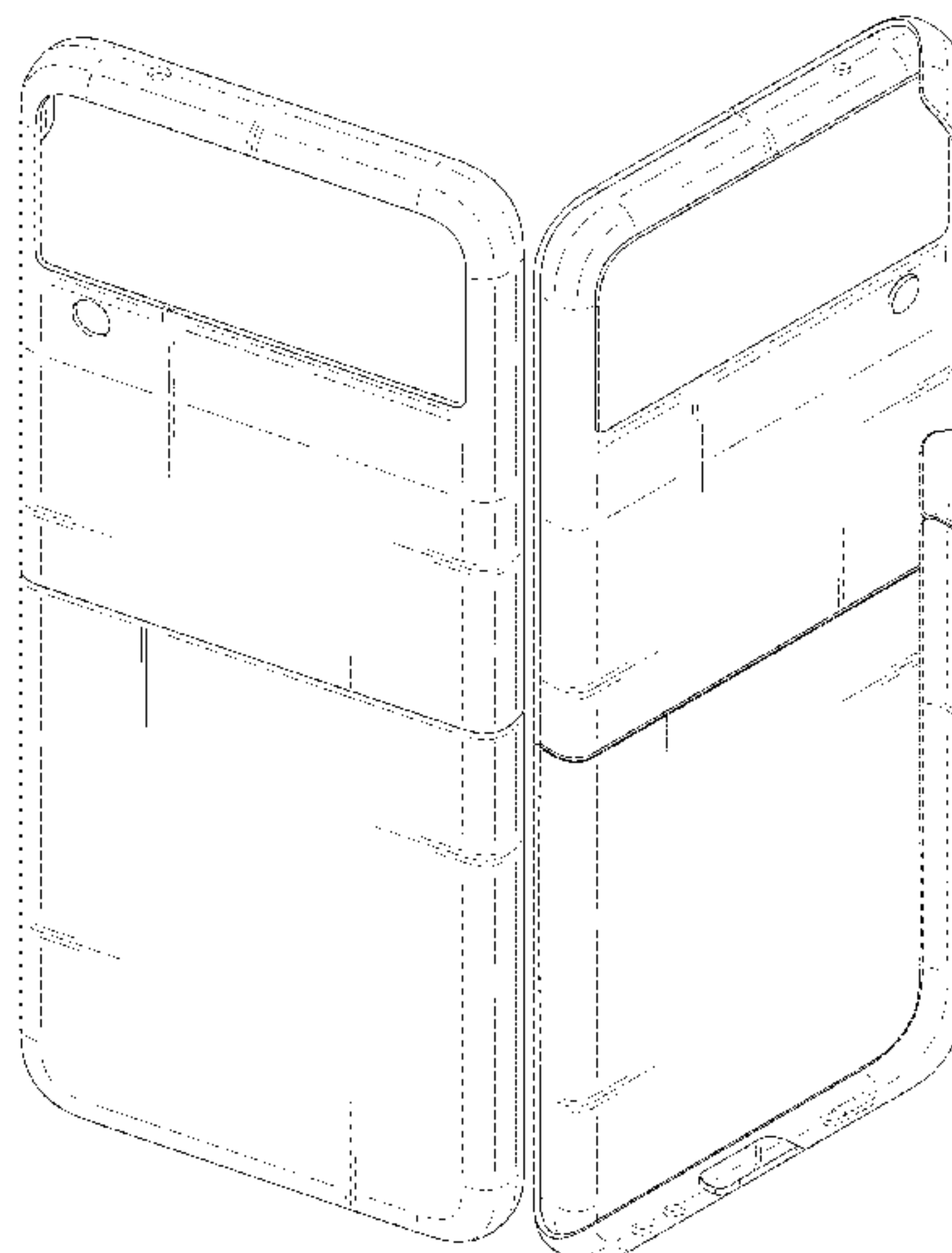

(56)

References Cited

U.S. PATENT DOCUMENTS

D911,323 S * 2/2021 Kim D14/250
D933,644 S * 10/2021 Choi D14/250
D935,170 S * 11/2021 Yang D3/218
D947,829 S * 4/2022 Choi D14/250
D954,014 S * 6/2022 Song D14/138 AB
D964,956 S * 9/2022 Gong D14/138 AB
D965,545 S * 10/2022 Song D14/138 AB
D965,547 S * 10/2022 Song D14/138 AB
D978,126 S * 2/2023 Liu D3/218
2017/0123217 A1 * 5/2017 Dukerschein G02B 30/37
2017/0188675 A1 * 7/2017 Ahmed A45C 13/005
2022/0166456 A1 * 5/2022 Dannenberg H04B 1/3888
2023/0029701 A1 * 2/2023 Lee H04M 1/0214

OTHER PUBLICATIONS

Samsung Galaxy Z Flip3 Clear Cover with Ring, publication date Aug. 11, 2021, [online] URL: <https://www.amazon.com/SAMSUNG-Galaxy-Flip3-Clear-Cover/dp/B098KKKYMB/> (Year: 2021).*

Samsung Galaxy Z Flip4 Silicone Cover with Ring, publication date Aug. 10, 2022, [online] URL: Samsung Galaxy Z Flip4 Silicone Cover with Ring (Year: 2022).*

Samsung Galaxy Z Flip4 Flap Leather Cover, publication date Aug. 10, 2022, [online] URL: <https://www.amazon.com/SAMSUNG-Leather-Protective-Premium-Version/dp/B0B3ZBWR46/> (Year: 2022).*

Samsung Galaxy Z Flip 4 Silicone Strap Cover, publication date Aug. 10, 2022, [online] URL: <https://www.amazon.com/SAMSUNG-Silicone-Protective-Surface-Handheld/dp/B0B3Z3WWYT> (Year: 2022).*

* cited by examiner

FIG. 1

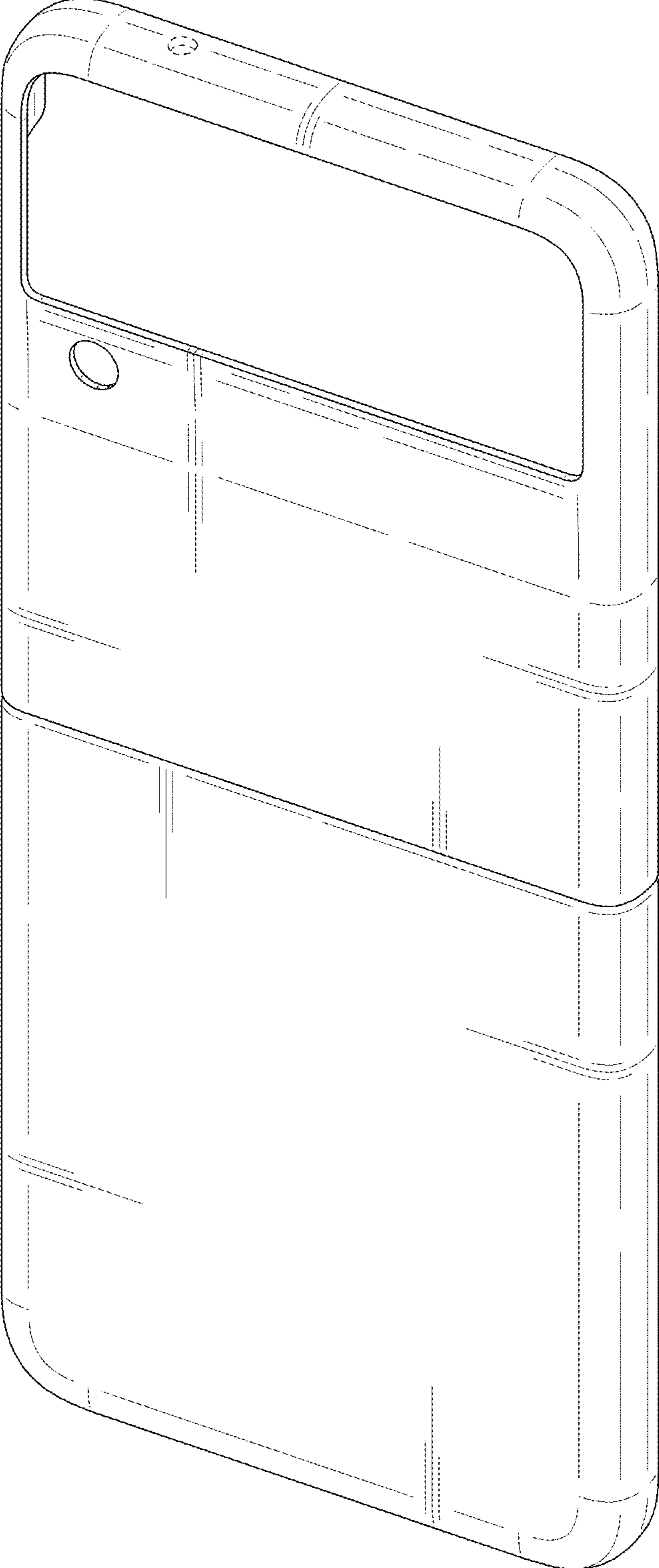

FIG. 2

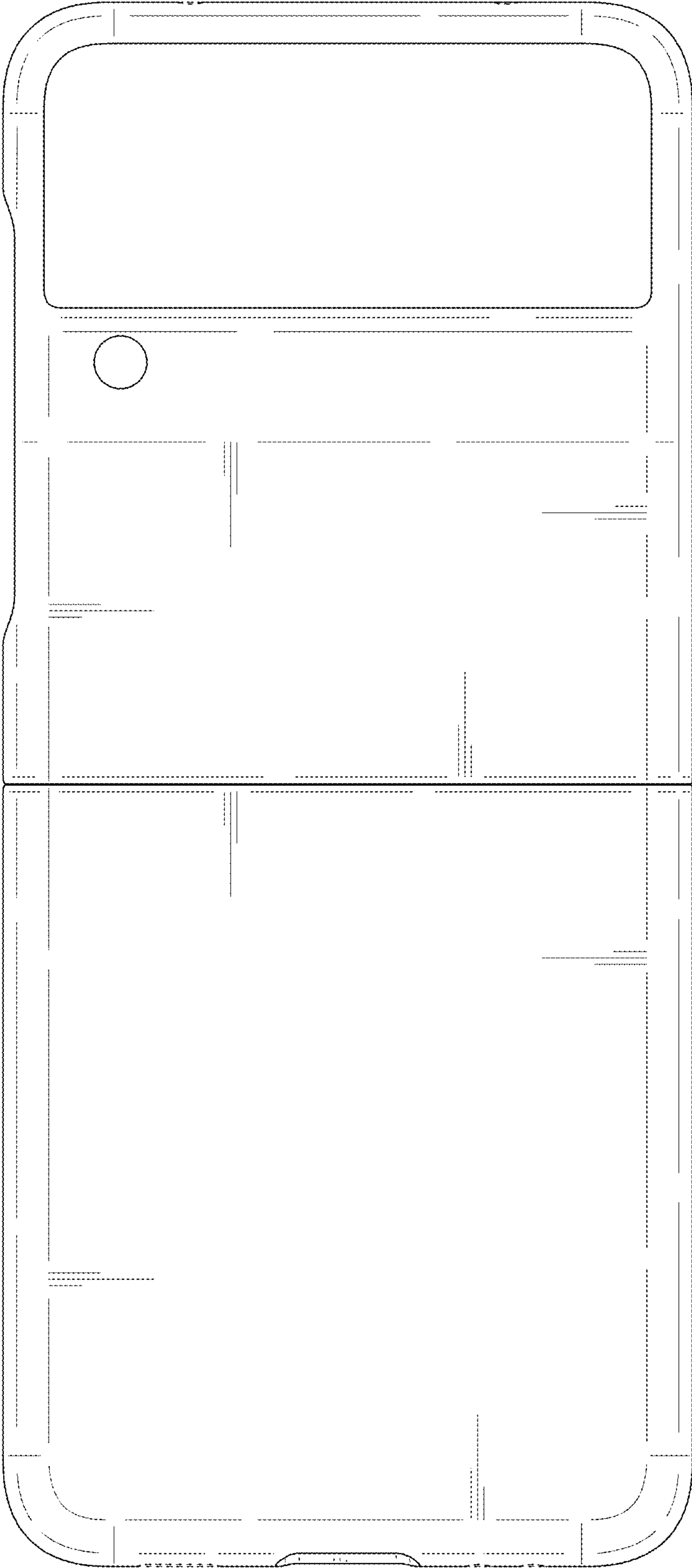

FIG. 3

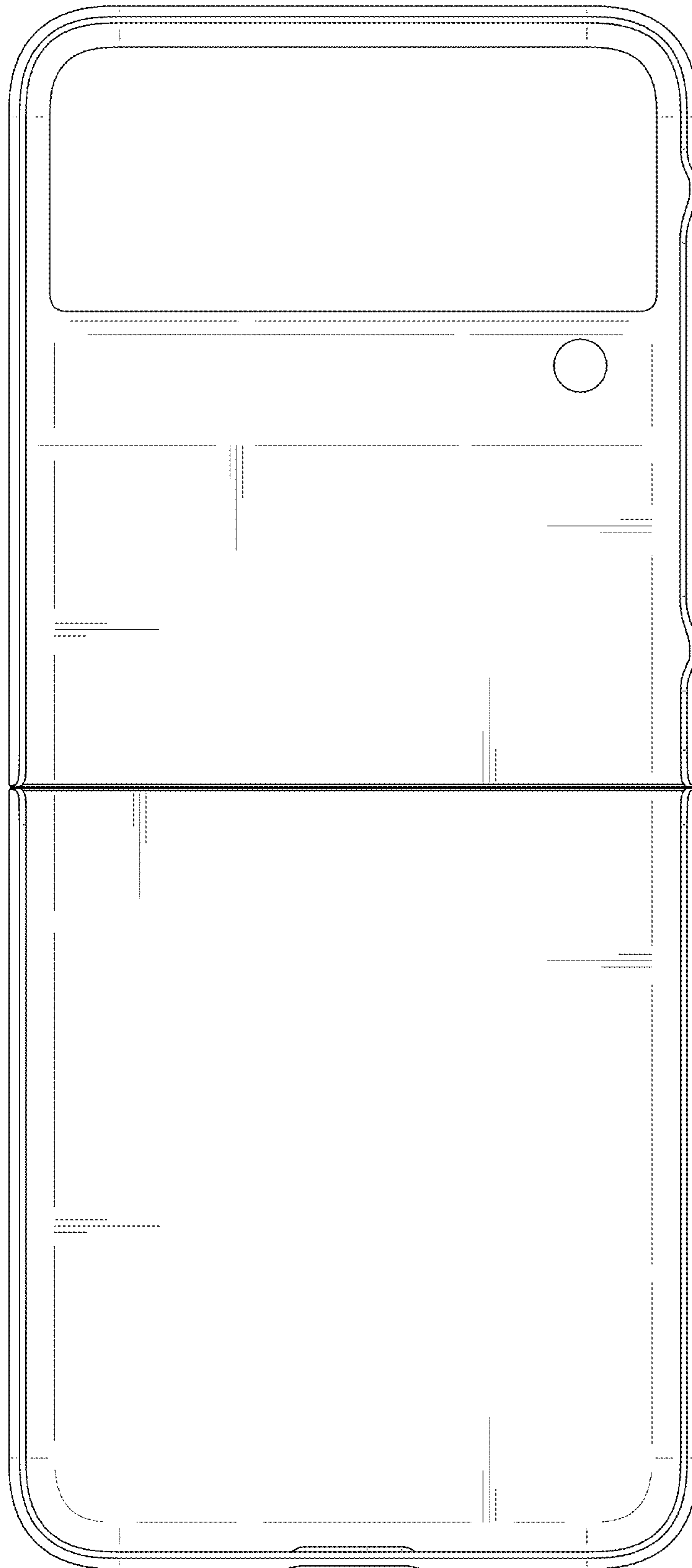

FIG. 4

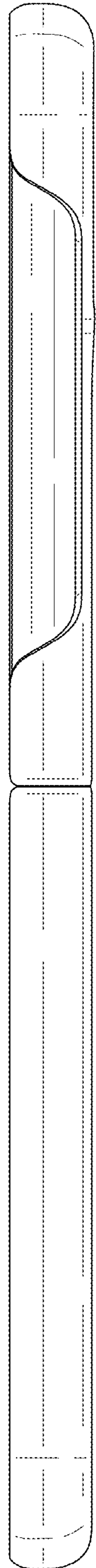

FIG. 5

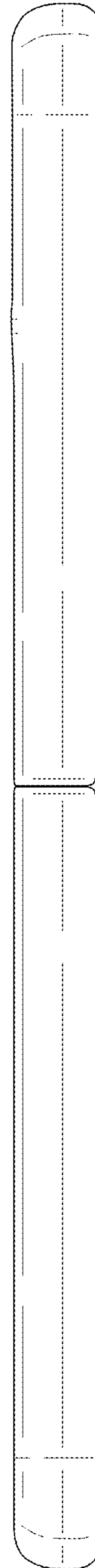

FIG. 6

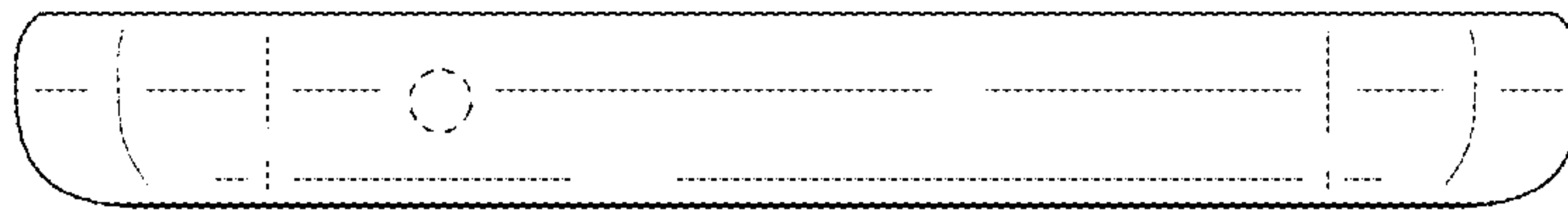

FIG. 7

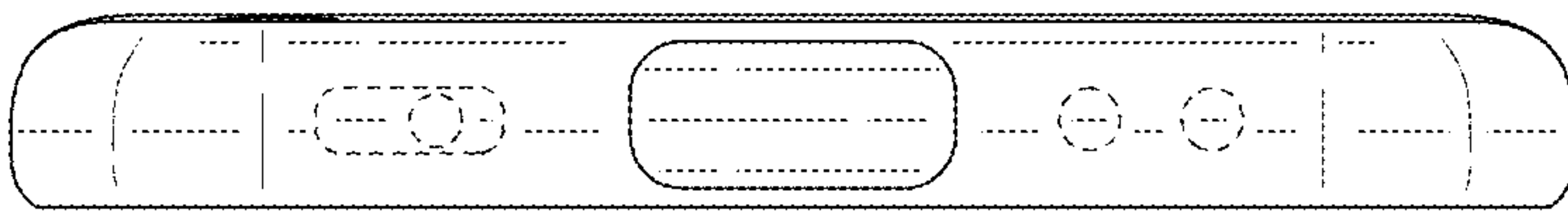

FIG. 8

