



US00D987502S

(12) **United States Design Patent**
Willing et al.

(10) **Patent No.:** **US D987,502 S**

(45) **Date of Patent:** **** May 30, 2023**

(54) **VEHICLE FRONT LOWER BUMPER COVER**

(71) Applicant: **Ford Global Technologies, LLC,**
Dearborn, MI (US)

(72) Inventors: **Todd Willing**, Grosse Pointe, MI (US);
Max Wolff, Elsternwick (AU); **Max Tran**, Pascoe Vale (AU); **Leigh H. Cosentino**, Seddon (AU); **Tae Hoon Kang**, Essendon (AU); **Lee P. Imrie**, Bundoora (AU)

(73) Assignee: **Ford Global Technologies, LLC,**
Dearborn, MI (US)

(**) Term: **15 Years**

(21) Appl. No.: **29/814,430**

(22) Filed: **Nov. 5, 2021**

(51) **LOC (14) Cl.** **12-16**

(52) **U.S. Cl.**
USPC **D12/169**

(58) **Field of Classification Search**
USPC D12/169, 196, 86, 90-92, 163, 190, 98,
D12/164; 293/102, 113, 115, 117, 120,
293/193.11; 296/180.1, 180.2
CPC B60R 19/02; B60R 19/04; B62D 25/08
See application file for complete search history.

(56) **References Cited**

U.S. PATENT DOCUMENTS

D923,531 S * 6/2021 Kaoud D12/169
D923,532 S * 6/2021 Kaoud D12/169

D925,412 S * 7/2021 Ponomarenko D12/169
D930,525 S * 9/2021 Lee D12/169
D945,331 S * 3/2022 Koo D12/169
D947,731 S * 4/2022 Hoste D12/169
D969,681 S * 11/2022 Ruiz D12/169
D976,775 S * 1/2023 Kaoud D12/169

* cited by examiner

Primary Examiner — Melody N Brown

(74) *Attorney, Agent, or Firm* — Vichit Chea

(57) **CLAIM**

The ornamental design for a vehicle front lower bumper cover, as shown and described.

DESCRIPTION

FIG. 1 is a front elevational view of a vehicle front lower bumper cover, showing our new design;
FIG. 2 is a left side elevational view thereof;
FIG. 3 is a right side elevational view thereof;
FIG. 4 is a top plan view thereof;
FIG. 5 is a bottom plan view thereof;
FIG. 6 is a bottom, front and left side perspective view thereof; and,
FIG. 7 is a top, front and left side perspective view thereof.
The claimed design is indicated by the relatively dark portions in the figures. The de-emphasized and relatively light portions form no part of the claimed design.

1 Claim, 7 Drawing Sheets

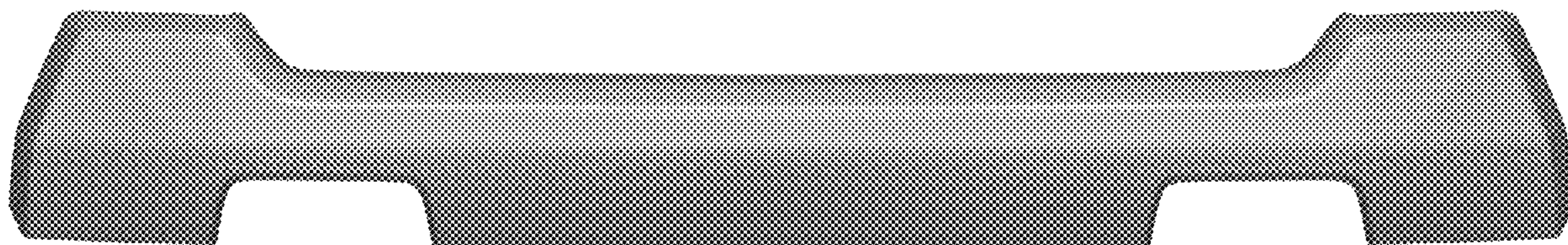

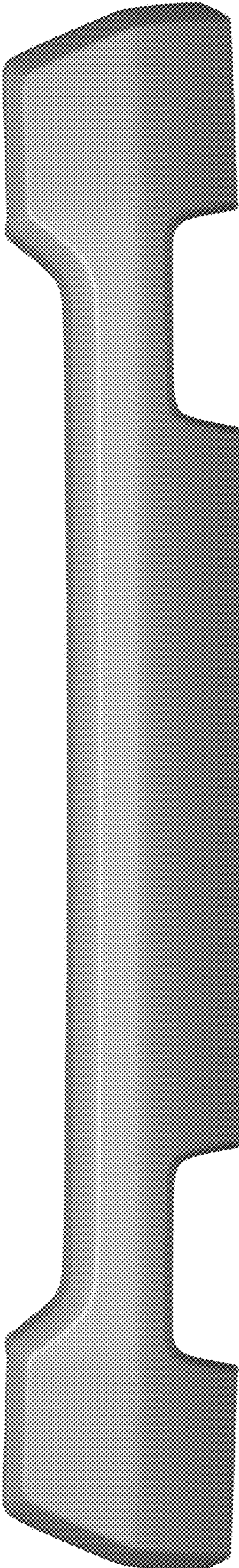

Fig.1

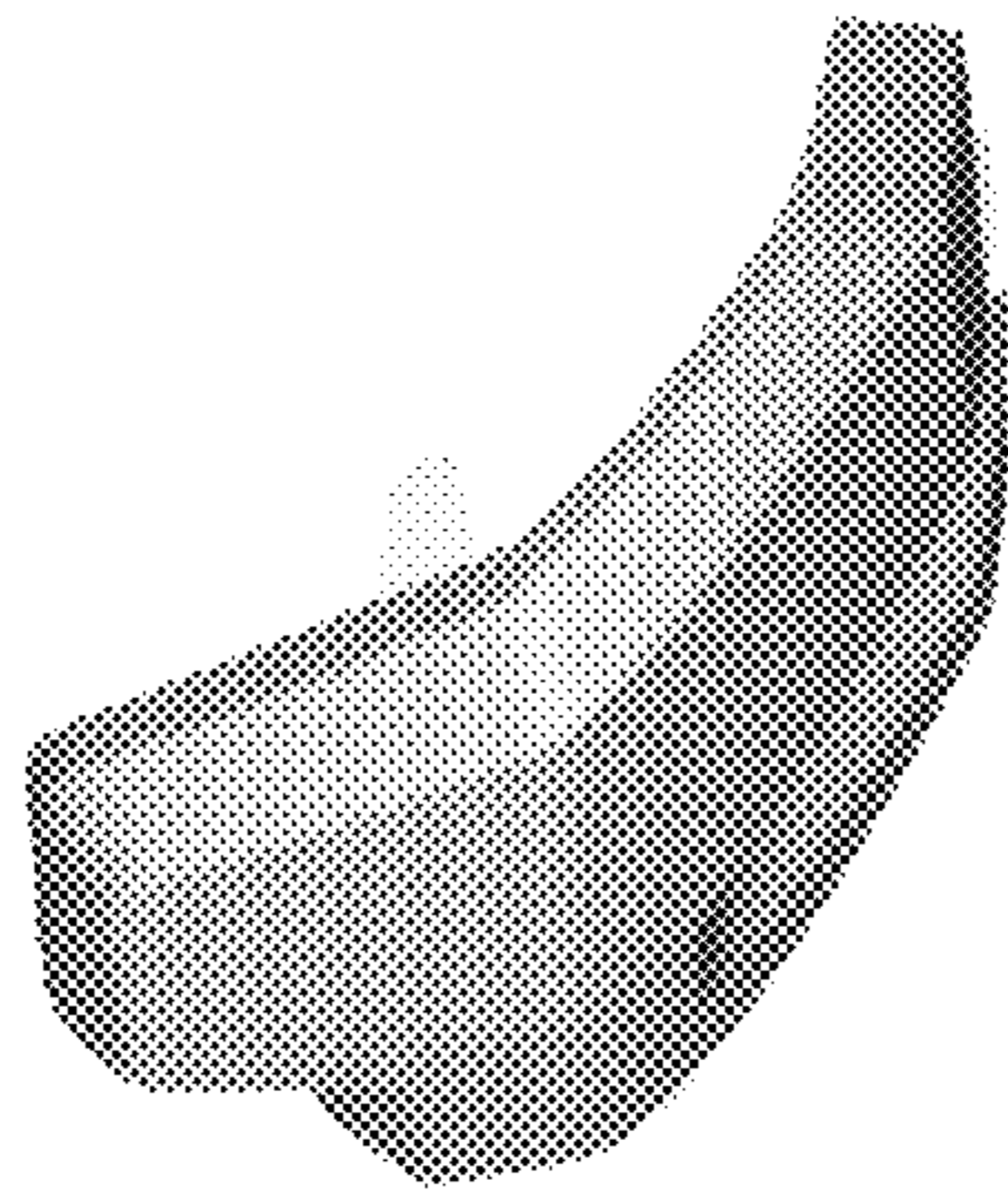

Fig. 2

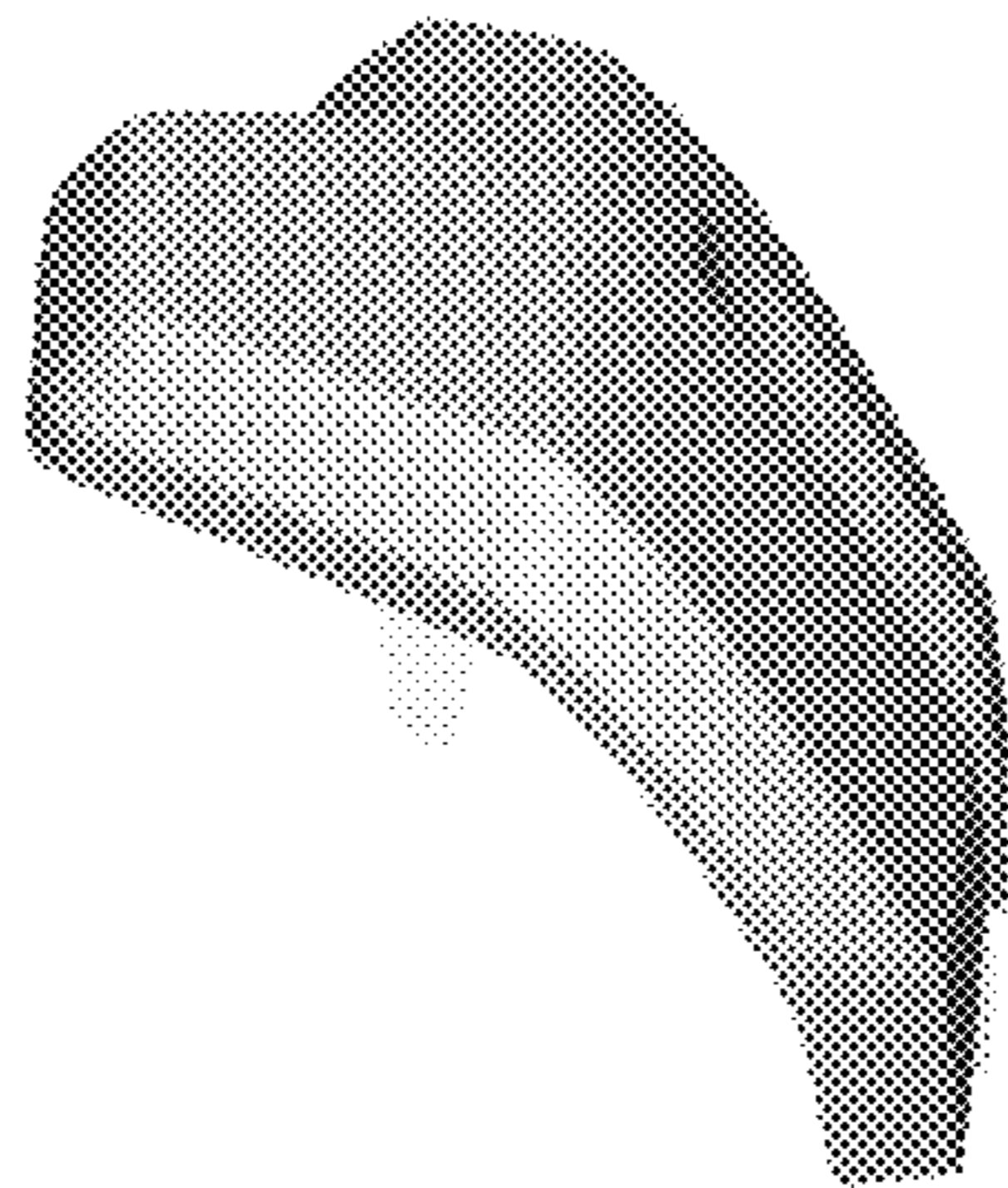

Fig. 3

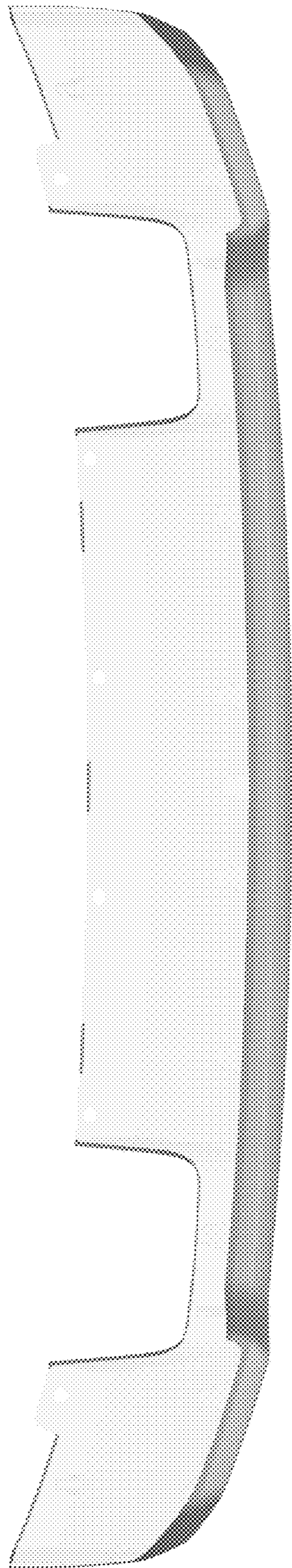

Fig.4



Fig. 5

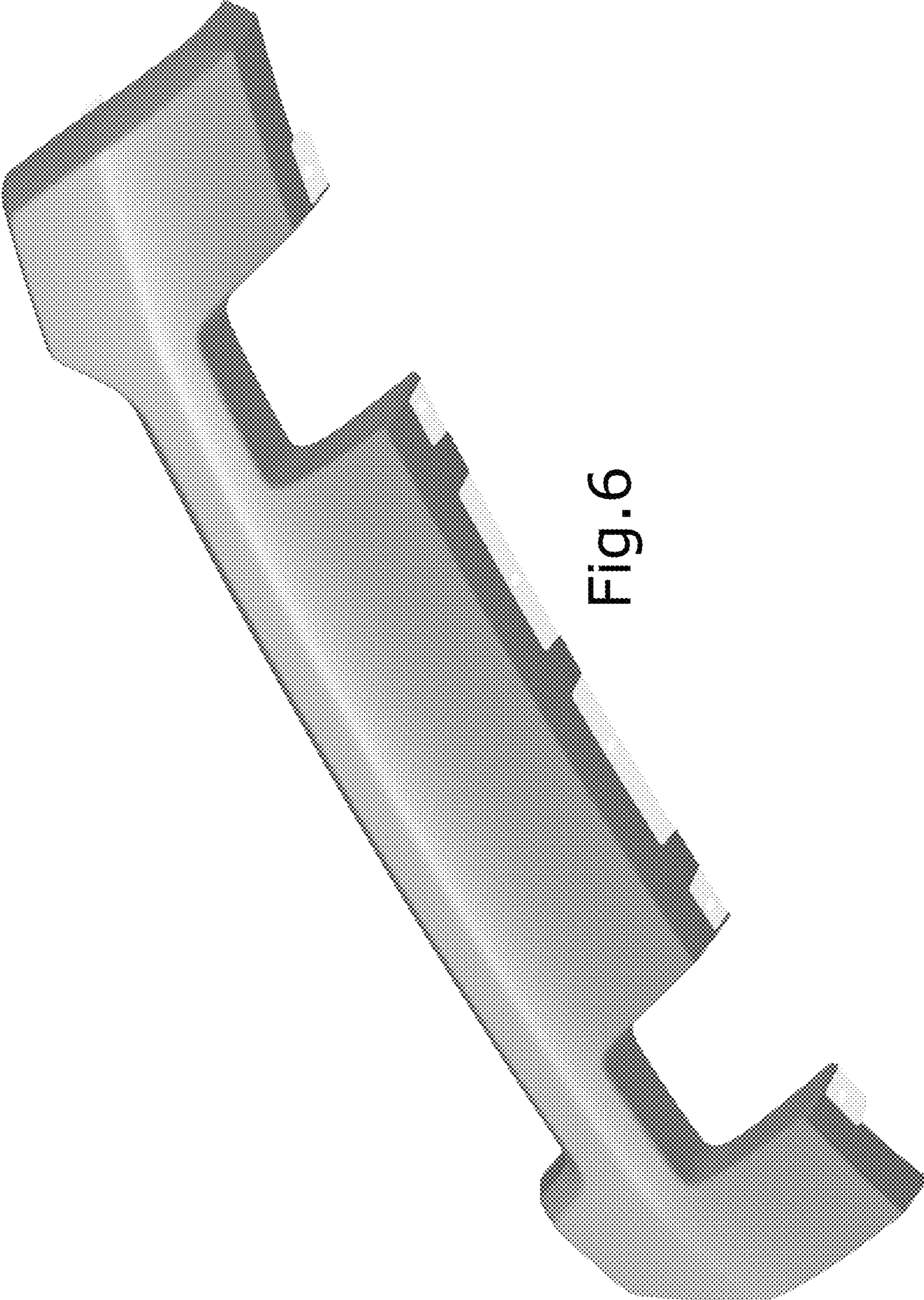

Fig. 6

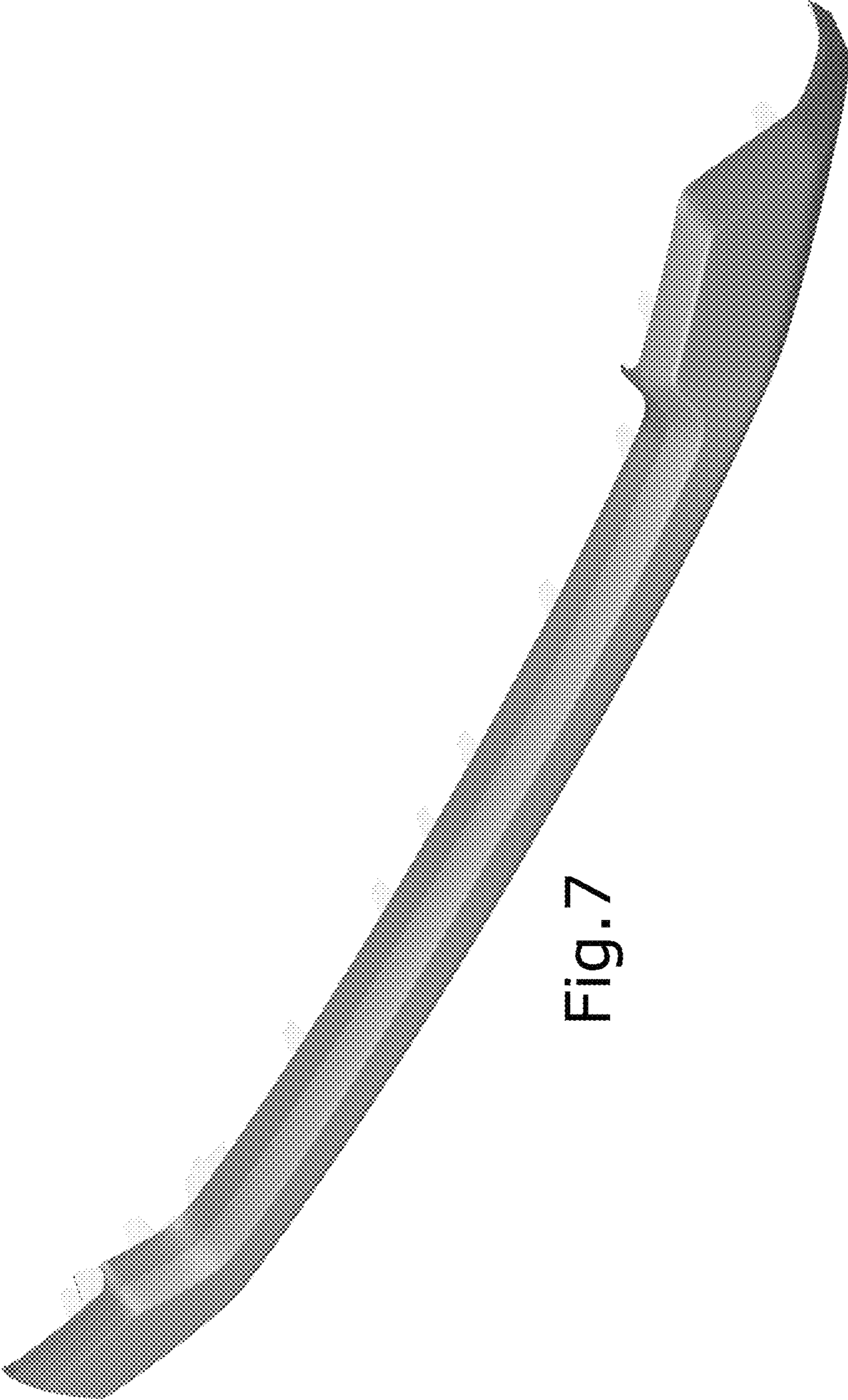

Fig. 7