



US00D987427S

(12) **United States Design Patent** (10) **Patent No.:** **US D987,427 S**
Roesler et al. (45) **Date of Patent:** **** May 30, 2023**

(54) **PACKAGING CONTAINER**

(71) Applicant: **ROESLER IP GMBH**, Hergensweiler (DE)

(72) Inventors: **Thiemo Roesler**, Wangen-Neuravensburg (DE); **Markus Mayer**, Lindau (DE)

(73) Assignee: **ROESLER IP GMBH**

(**) Term: **15 Years**

(21) Appl. No.: **29/783,784**

(22) Filed: **May 14, 2021**

(51) **LOC (14) Cl.** **09-03**

(52) **U.S. Cl.**
USPC **D9/415**

(58) **Field of Classification Search**
USPC D9/414, 415, 424, 430, 431, 737; D24/117, 118, 227
CPC B65D 75/326; B65D 77/26; B65D 2575/329; B65D 65/40; B65D 83/02; B65D 75/525; B65D 85/00; B65D 2205/02; B65D 31/16
See application file for complete search history.

8,042,689 B2 * 10/2011 Frojd A61M 25/0637 206/467
9,827,063 B1 * 11/2017 Barnell B65D 25/105
D811,210 S * 2/2018 Gustavsson D9/415
9,943,664 B2 * 4/2018 Gustavsson A61M 25/002
2006/0021890 A1 * 2/2006 Wang A61M 37/0076 206/363
2013/0292393 A1 * 11/2013 Doherty B65D 25/103 220/675
2015/0283332 A1 * 10/2015 Woehr A61M 5/3202 221/26
2018/0193847 A1 * 7/2018 Gottermeier A61B 5/150343
2022/0024662 A1 * 1/2022 Brockmann B65D 77/26
2022/0177211 A1 * 6/2022 Beck B65D 75/527

* cited by examiner

Primary Examiner — Lauren R Calve
(74) *Attorney, Agent, or Firm* — Dentons Cohen & Grigsby P.C.

(57) **CLAIM**

An ornamental design for a packaging container, as shown.

DESCRIPTION

FIG. 1 is a top perspective view of the packaging container.
FIG. 2 is a front view of the packaging container.
FIG. 3 is a back view of the packaging container.
FIG. 4 is a top view of the packaging container.
FIG. 5 is a bottom view of the packaging container.
FIG. 6 is a right side view of the packaging container; and,
FIG. 7 is a left side view of the packaging container.
The broken line showing in FIGS. 3-7 is for the purpose of illustrating portions of the packaging container and forms no part of the claimed design.

1 Claim, 6 Drawing Sheets

(56) **References Cited**

U.S. PATENT DOCUMENTS

3,353,664 A * 11/1967 Armentrout A61M 5/002 206/459.5
5,392,909 A * 2/1995 Hackett A61B 50/3001 206/451
5,407,070 A * 4/1995 Bascos A61M 5/002 206/467

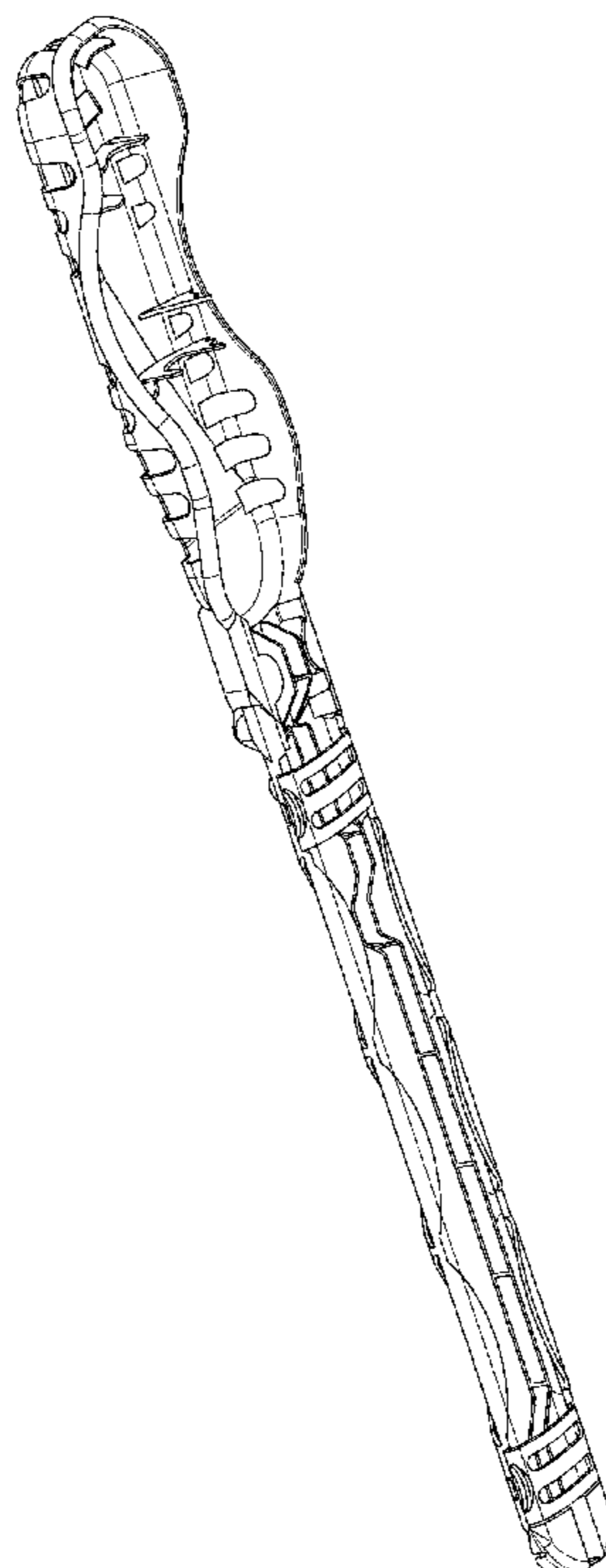

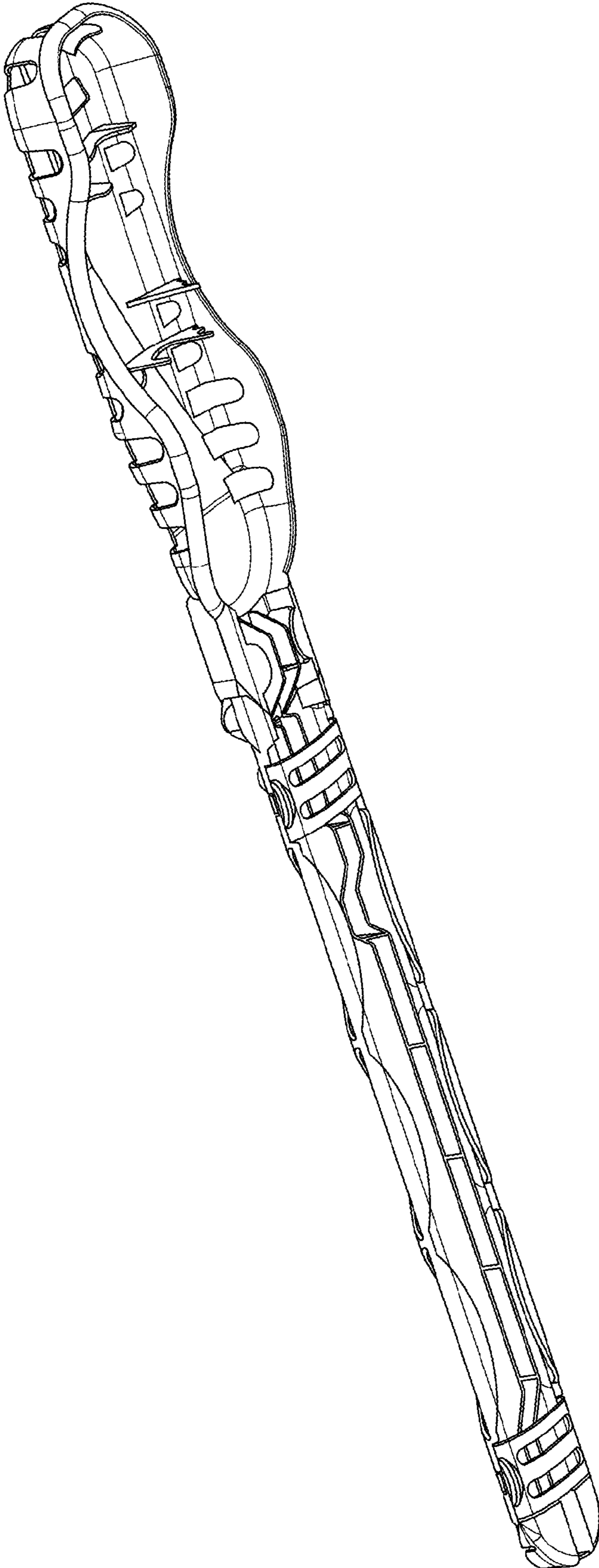

FIG. 1

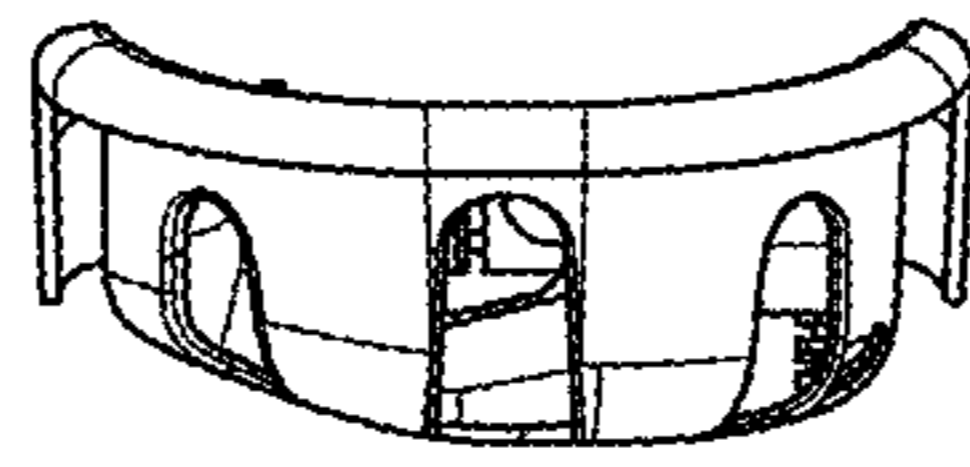

FIG. 2

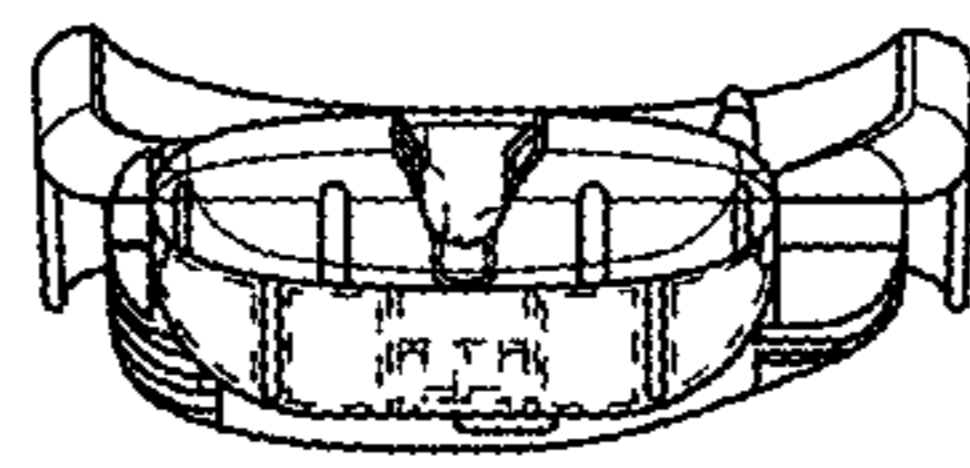

FIG. 3

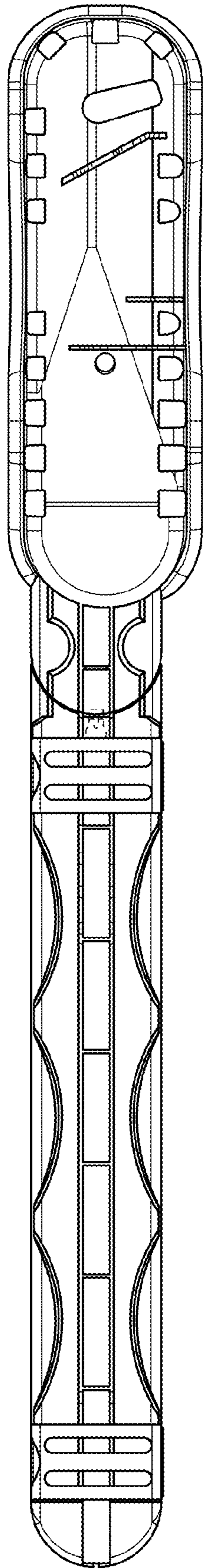

FIG. 4

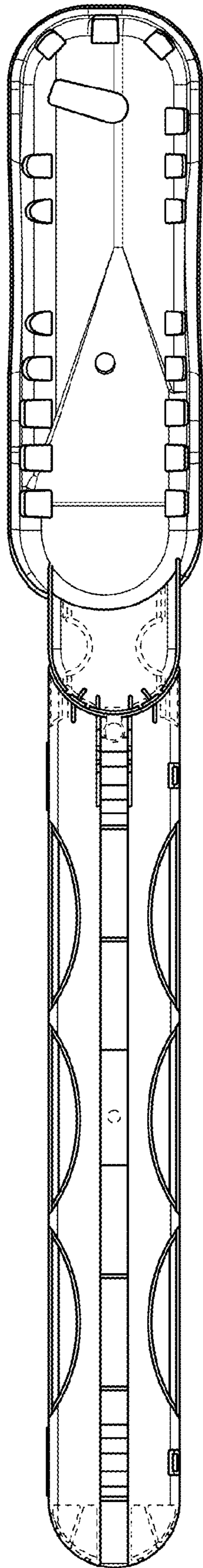

FIG. 5

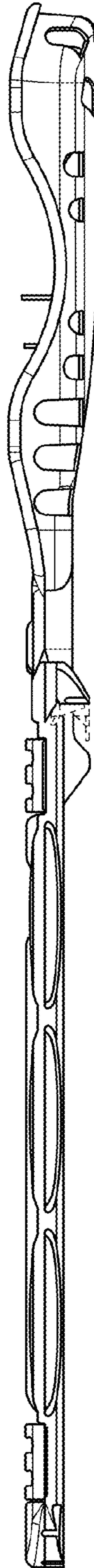

FIG. 6

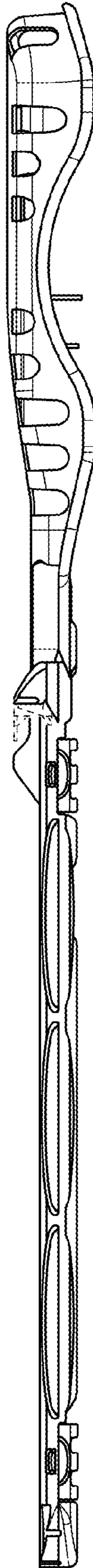

FIG. 7