



US00D987221S

(12) **United States Design Patent** (10) **Patent No.:** **US D987,221 S**
Hu (45) **Date of Patent:** **** May 23, 2023**

(54) **SCRAPER**
(71) Applicant: **Shiming Hu**, Pingxiang (CN)
(72) Inventor: **Shiming Hu**, Pingxiang (CN)
(**) Term: **15 Years**
(21) Appl. No.: **29/886,015**
(22) Filed: **Mar. 3, 2023**
(51) **LOC (14) Cl.** **07-05**
(52) **U.S. Cl.**
USPC **D32/48**
(58) **Field of Classification Search**
USPC D32/40, 46, 48, 49; D8/105, 98, 45
CPC .. A46B 13/02; A47J 37/07; A47L 1/16; A47L
13/02; A47L 13/10; A47L 13/12; B60S
3/04; B60S 1/38; B25G 1/10; B25B
13/04; B66F 15/00; B66F 17/00; E04F
21/1652
See application file for complete search history.

(56) **References Cited**

U.S. PATENT DOCUMENTS

D377,856	S	*	2/1997	Hartman	D32/48
D420,882	S	*	2/2000	Majolo	D32/46
D542,491	S	*	5/2007	Barnes, Jr.	D32/49
D605,911	S	*	12/2009	Lian	D8/14
D687,201	S	*	7/2013	Liao	D32/46
9,376,825	B2	*	6/2016	Liao	E04F 21/1655
9,637,935	B2	*	5/2017	Chen	E04F 21/165
D841,918	S	*	2/2019	Tschopp	D32/46
D891,898	S	*	8/2020	Yao	D32/46
D915,702	S	*	4/2021	Liao	D32/46
D916,408	S		4/2021	Lin		
D916,409	S	*	4/2021	Liao	D32/46
D946,227	S	*	3/2022	Anderson	D32/46
D950,179	S	*	4/2022	Buckley	D32/46
D960,476	S	*	8/2022	Scimone	D32/46
2010/0162509	A1	*	7/2010	Liao	E04F 21/1652 15/235.7

2010/0162573 A1* 7/2010 Liao E04F 21/1652
30/169
2015/0330091 A1* 11/2015 Liao E04F 21/1652
15/105.5
2023/0065115 A1* 3/2023 Rajan B60S 1/3463

OTHER PUBLICATIONS

ToolsDIY.co.uk visited Mar. 21, 2023, Rolson 3pc silicon scraper kit, <https://www.toolsdiy.co.uk/3pc-silicone-scraper-kit> (Year: 2023).*
3-in-1 sealant scraper, site visited Mar. 21, 2023, <https://nueby.com/product/sealant-scraper> (Year: 2023).*

* cited by examiner

Primary Examiner — Cynthia Ramirez
(74) *Attorney, Agent, or Firm* — Daniel M. Cohn;
Howard M. Cohn

(57) **CLAIM**

The ornamental design for a scraper, as shown and described.

DESCRIPTION

FIG. 1 is a perspective view of a scraper showing my new design;
FIG. 2 is another perspective view thereof;
FIG. 3 is a front elevational view thereof;
FIG. 4 is a rear elevational view thereof;
FIG. 5 is a left side elevational view thereof;
FIG. 6 is a right side elevational view thereof;
FIG. 7 is a top plan view thereof;
FIG. 8 is a bottom plan view thereof;
FIG. 9 is a perspective view of the scraper, shown in an open configuration; and,
FIG. 10 is another perspective view of the scraper, shown in an open configuration.
The dash-dash broken lines in the drawings depict portions of the scraper that form no part of the claimed design.

1 Claim, 10 Drawing Sheets

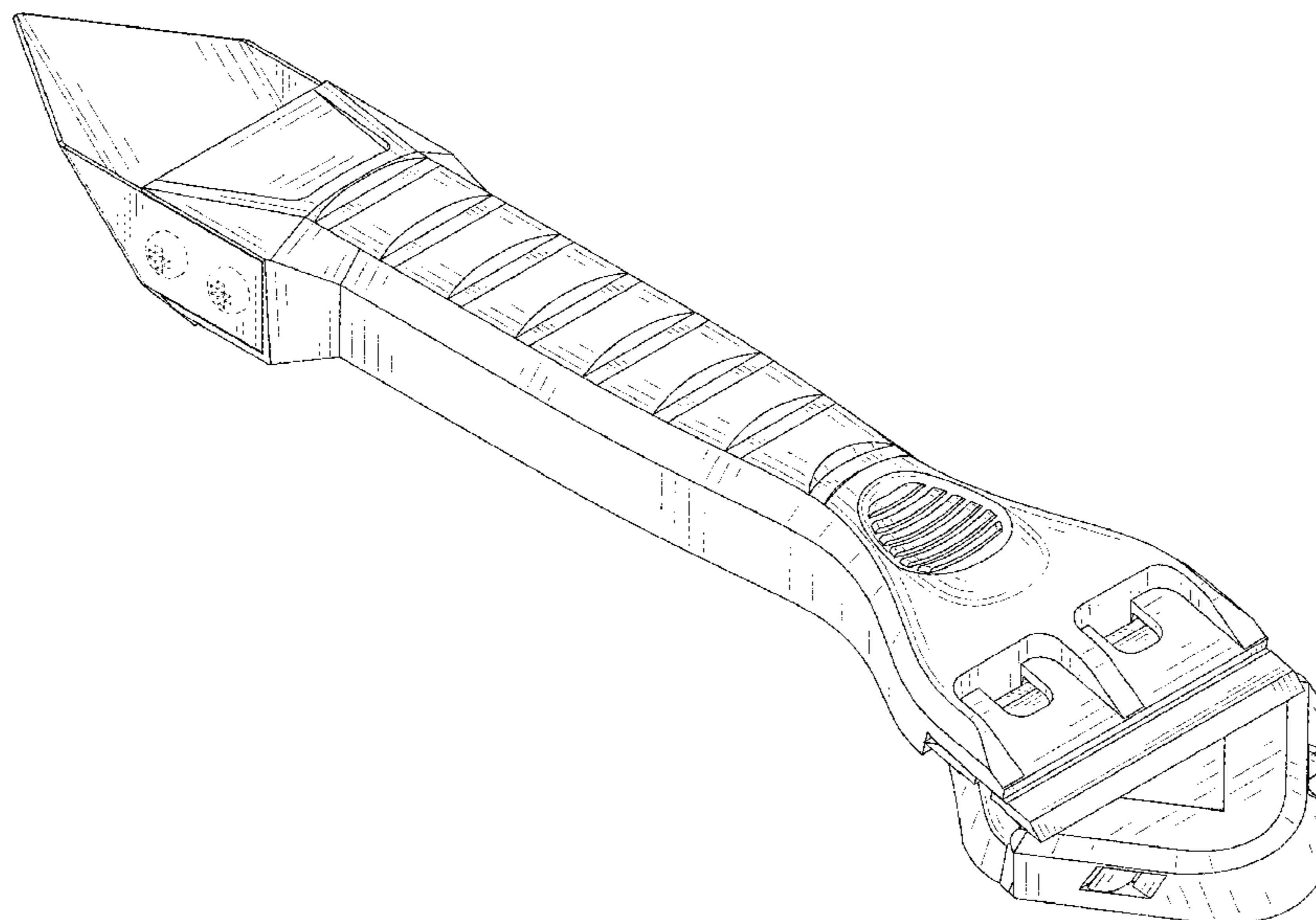

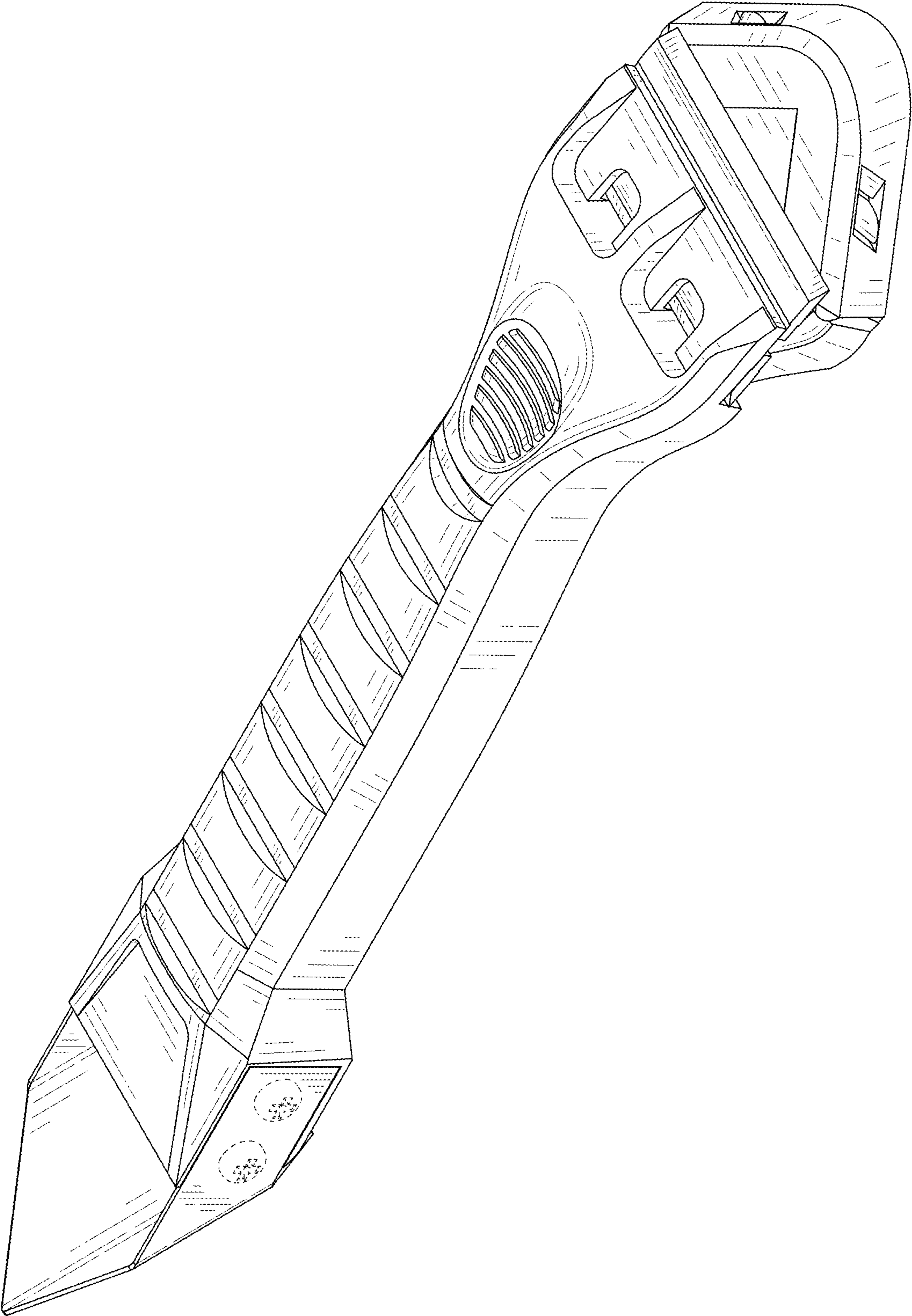

FIG. 1

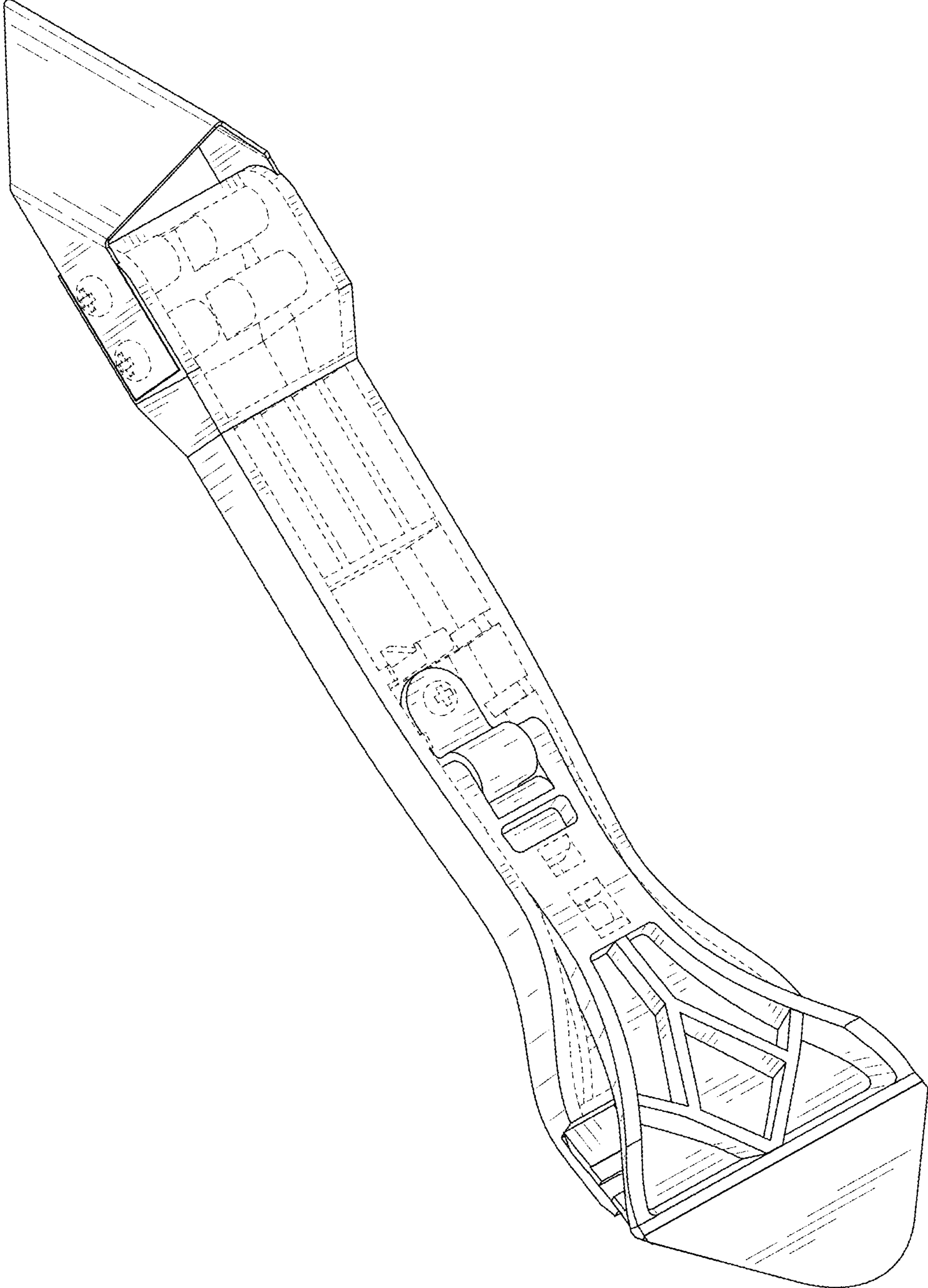

FIG. 2

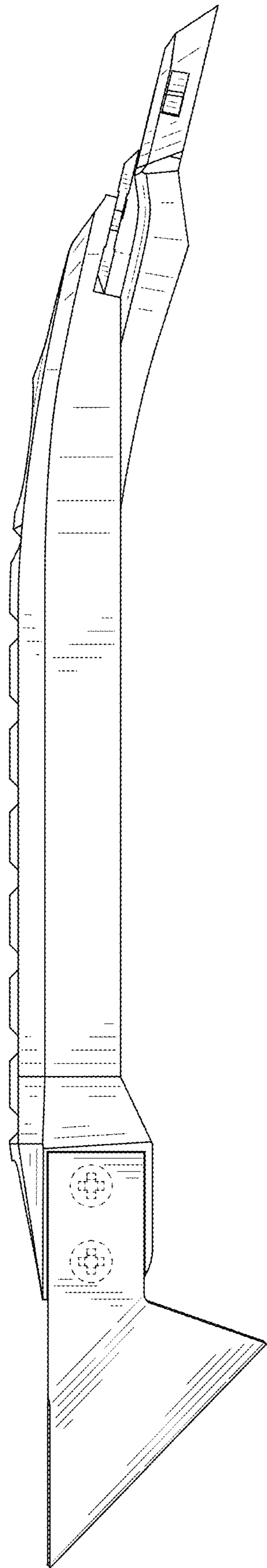

FIG. 3

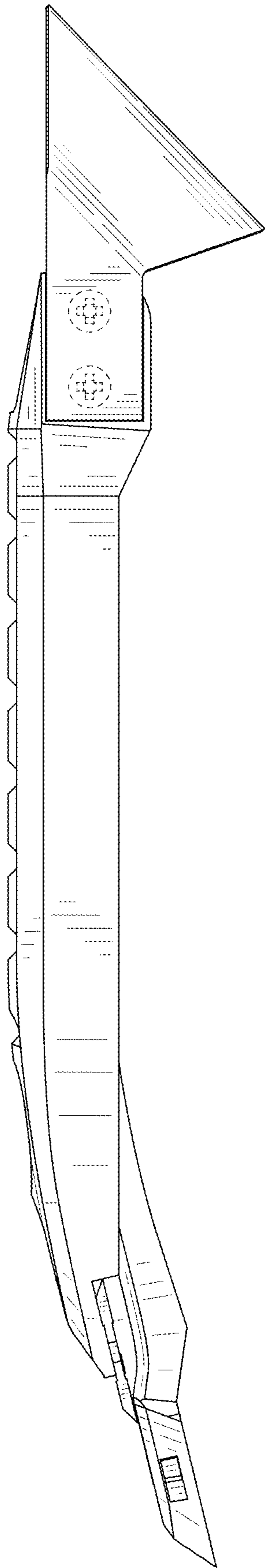

FIG. 4

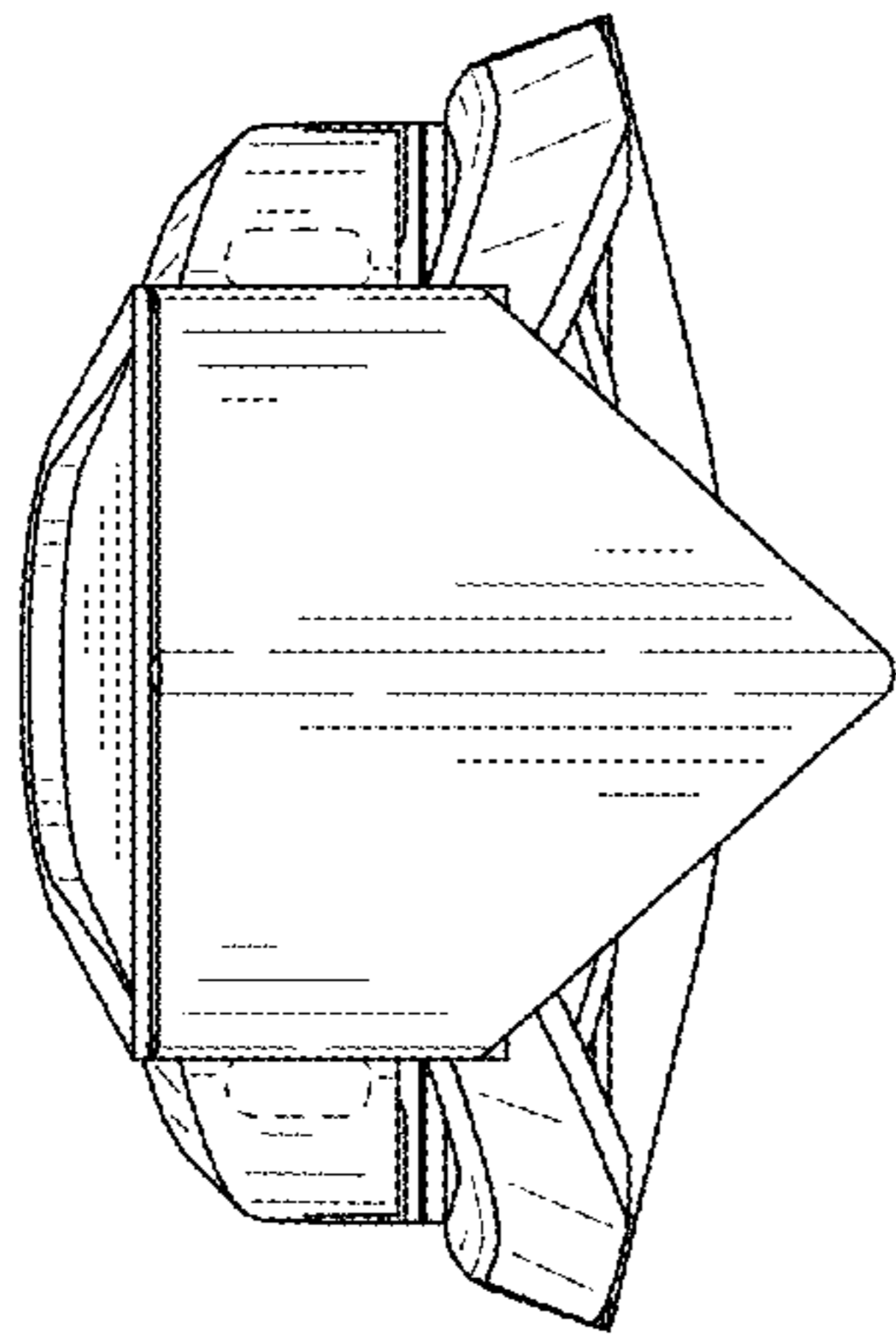

FIG. 5

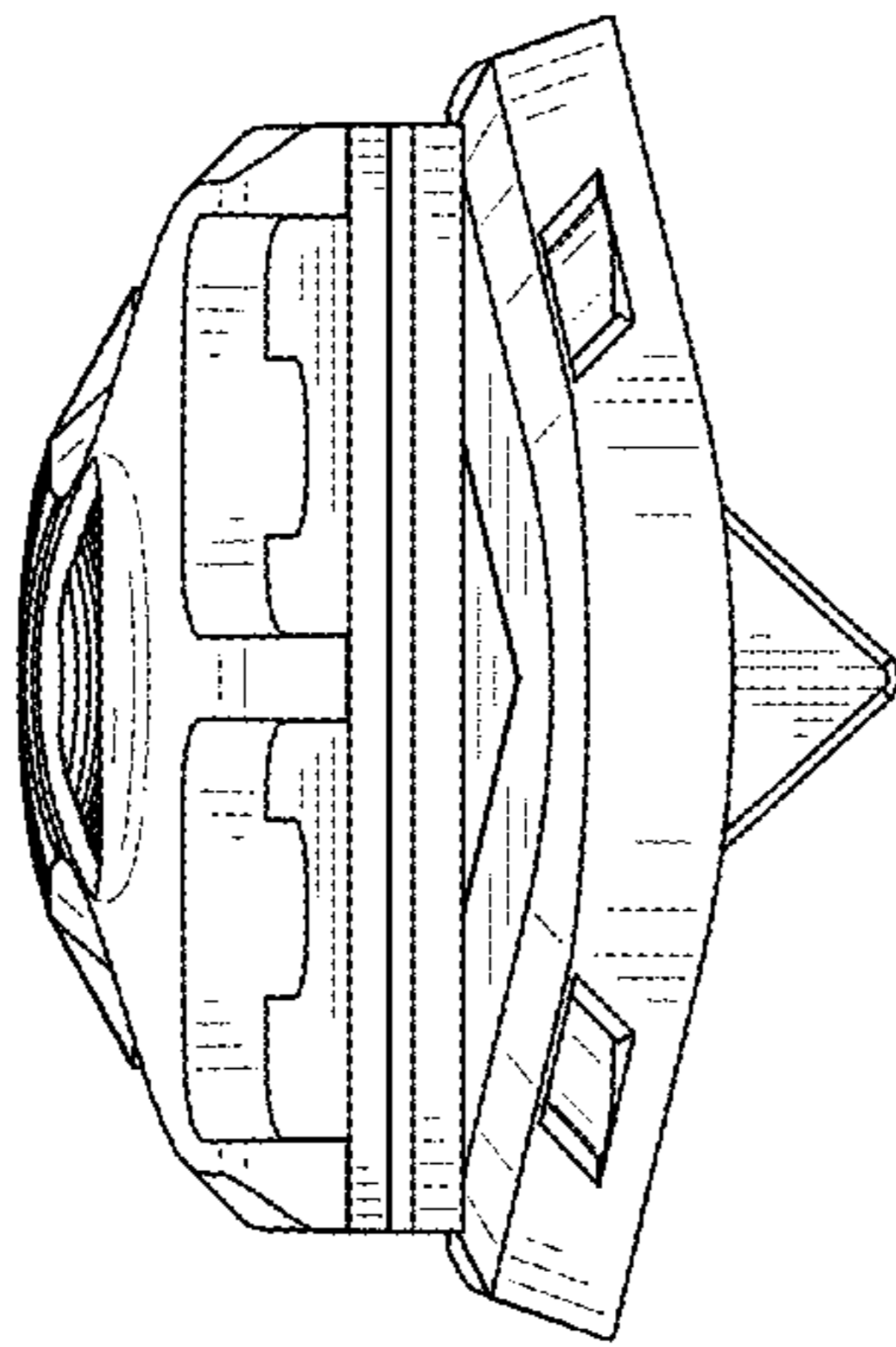

FIG. 6

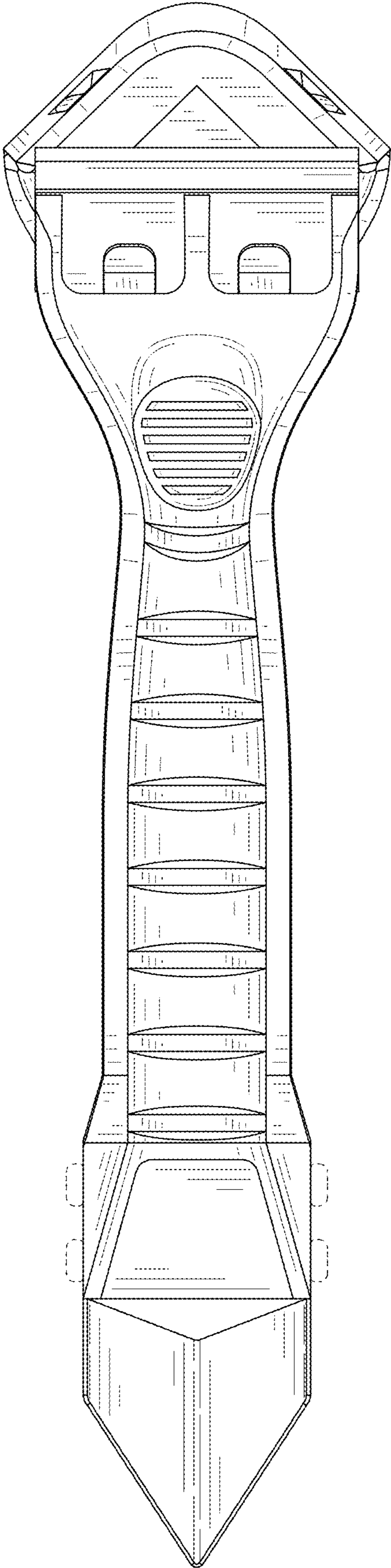

FIG. 7

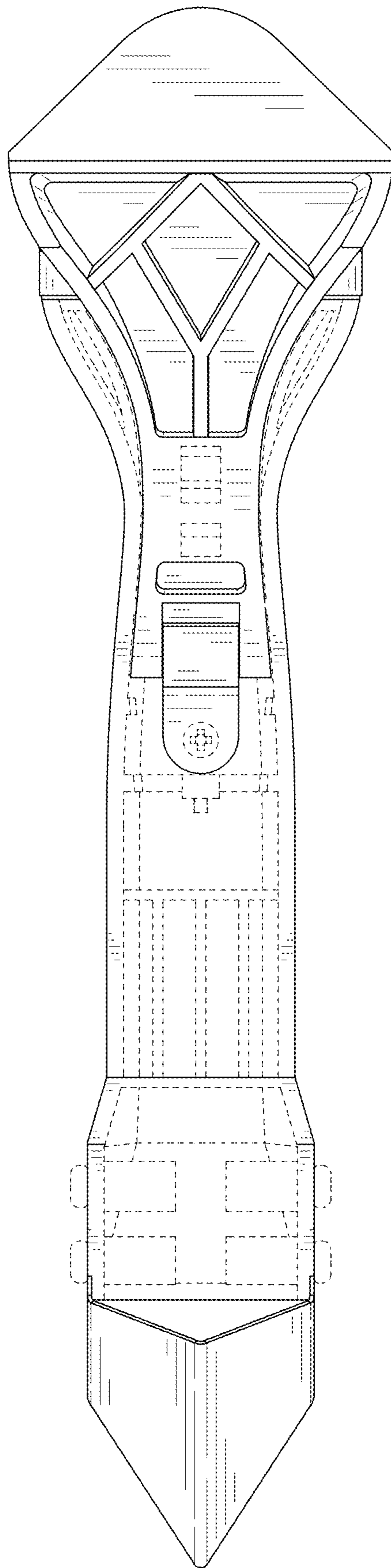

FIG. 8

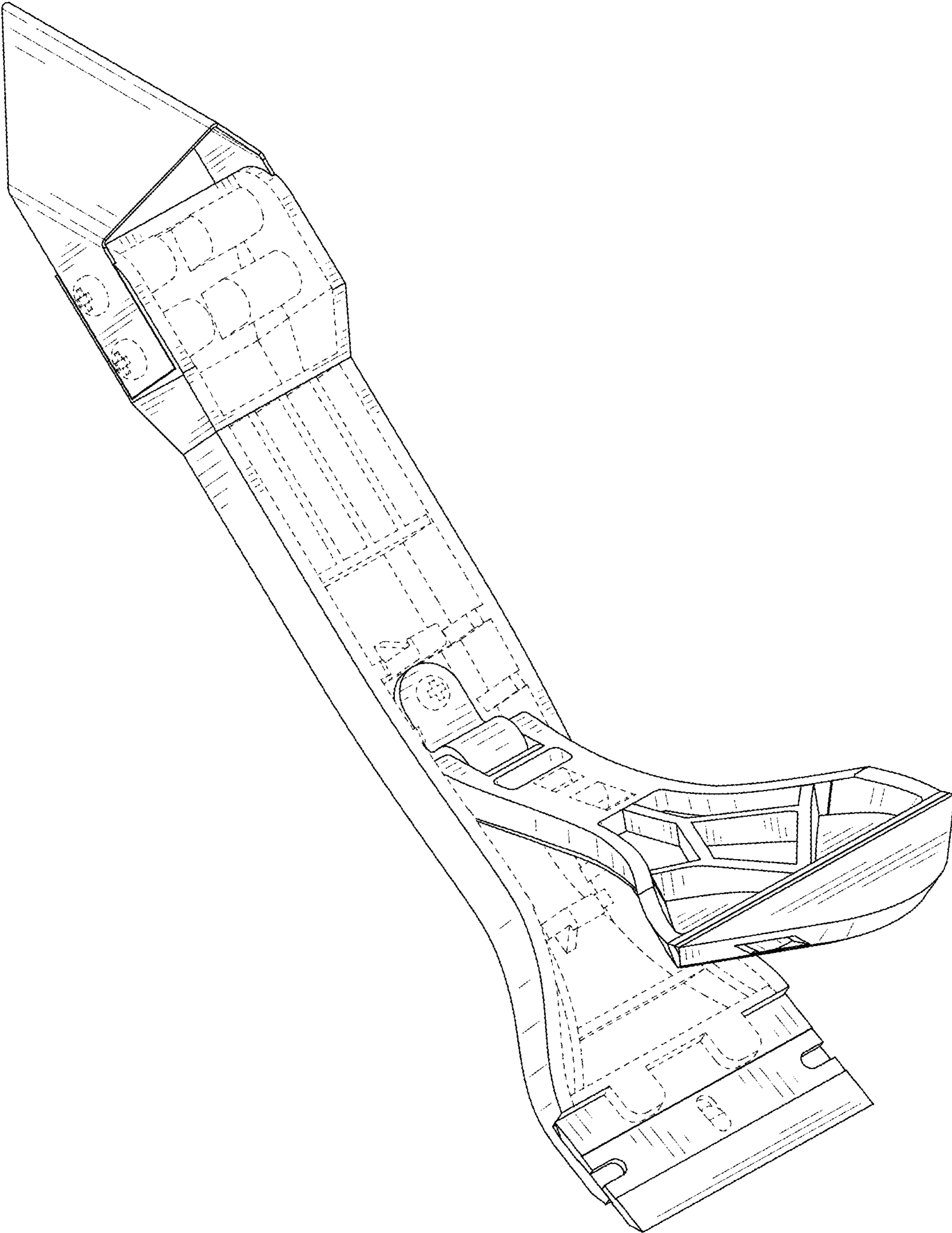

FIG. 9

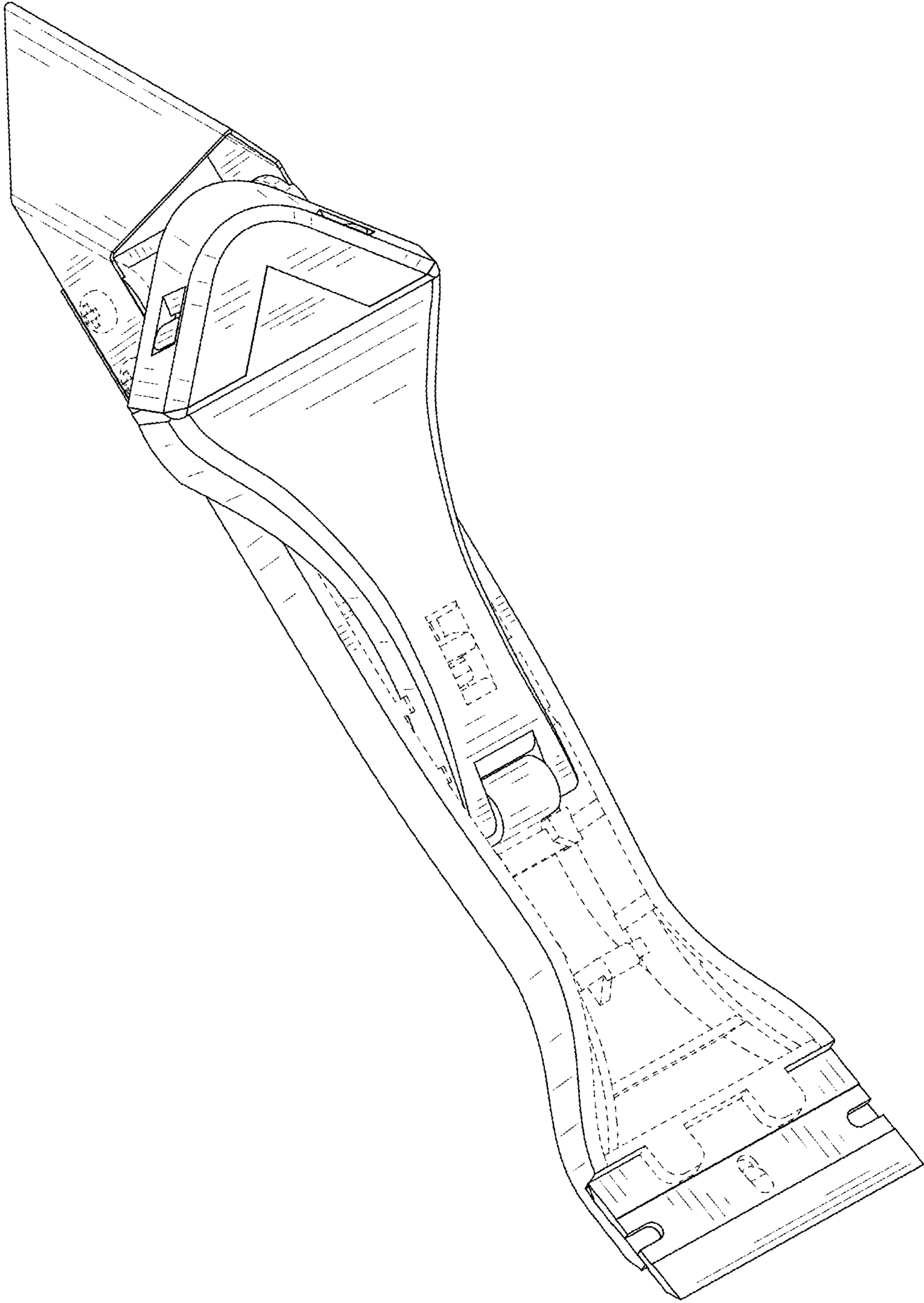

FIG. 10