



US00D987187S

(12) **United States Design Patent** (10) **Patent No.:** **US D987,187 S**
Zeng (45) **Date of Patent:** **** May 23, 2023**

(54) **BACK SHAVER HEAD**
(71) Applicant: **NATURE LAB CORPORATION,**
Aurora, CO (US)
(72) Inventor: **Xianqin Zeng,** Aurora, CO (US)
(73) Assignee: **NATURE LAB CORPORATION,**
Aurora, CO (US)
(**) Term: **15 Years**
(21) Appl. No.: **29/839,747**
(22) Filed: **May 24, 2022**
(51) **LOC (14) Cl.** **28-03**
(52) **U.S. Cl.**
USPC **D28/47**
(58) **Field of Classification Search**
USPC D28/47, 54
CPC B26B 21/22-222; B26B 21/4031; B26B
21/4012
See application file for complete search history.

2014/0068948 A1* 3/2014 Marder B26B 21/52
30/47
2014/0259679 A1* 9/2014 Tracy B26B 21/52
30/50
2022/0080610 A1* 3/2022 Starr B26B 21/52

FOREIGN PATENT DOCUMENTS

KR 20210056638 A * 5/2021

* cited by examiner

Primary Examiner — Jennifer Rivard

(74) *Attorney, Agent, or Firm* — Daniel M. Cohn;
Howard M. Cohn

(57) **CLAIM**

The ornamental design for a back shaver head, as shown and described.

DESCRIPTION

FIG. 1 is a perspective view of a back shaver head showing my new design;
FIG. 2 is another perspective view thereof;
FIG. 3 is a front elevational view thereof;
FIG. 4 is a rear elevational view thereof;
FIG. 5 is a left side elevational view thereof;
FIG. 6 is a right side elevational view thereof;
FIG. 7 is a top plan view thereof;
FIG. 8 is a bottom plan view thereof; and,
FIG. 9 is a perspective view of the back shaver head where the back shaver head is in a configuration of use.
The broken lines in FIG. 9 showing a handle depict environment and form no part of the claimed design. The other broken lines in the drawings depict portions of the back shaver head that form no part of the claimed design.

(56) **References Cited**
U.S. PATENT DOCUMENTS
D858,879 S * 9/2019 Brormann B26B 21/28
D28/47
D861,986 S 10/2019 Wang et al.
D921,293 S * 6/2021 Langberg D28/47
D933,298 S 10/2021 Parambathkandi Abdulhakkim
et al.
D952,256 S * 5/2022 Langberg D28/47
11,345,056 B1 * 5/2022 Wang B26B 21/14
11,511,449 B1 * 11/2022 Zeng B26B 21/521
11,529,747 B1 * 12/2022 Zeng B26B 21/4062
D975,360 S * 1/2023 Soerjo D28/47
2009/0288304 A1 * 11/2009 Denkert B26B 21/227
30/346.61

1 Claim, 9 Drawing Sheets

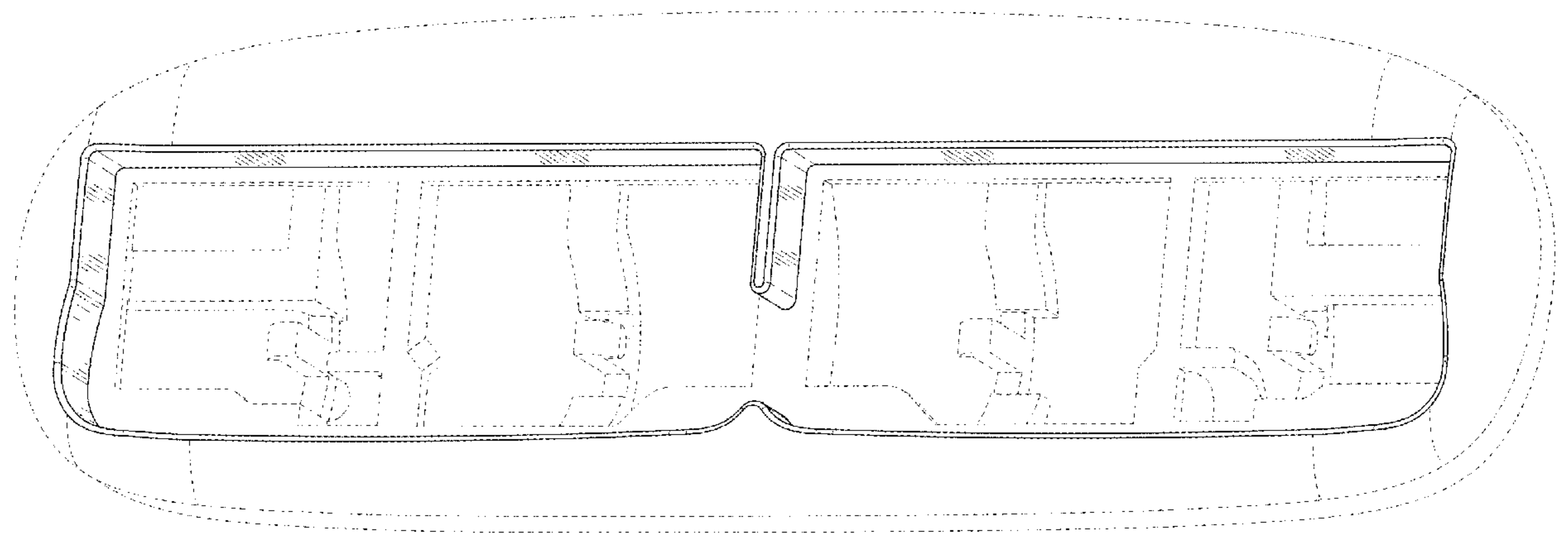

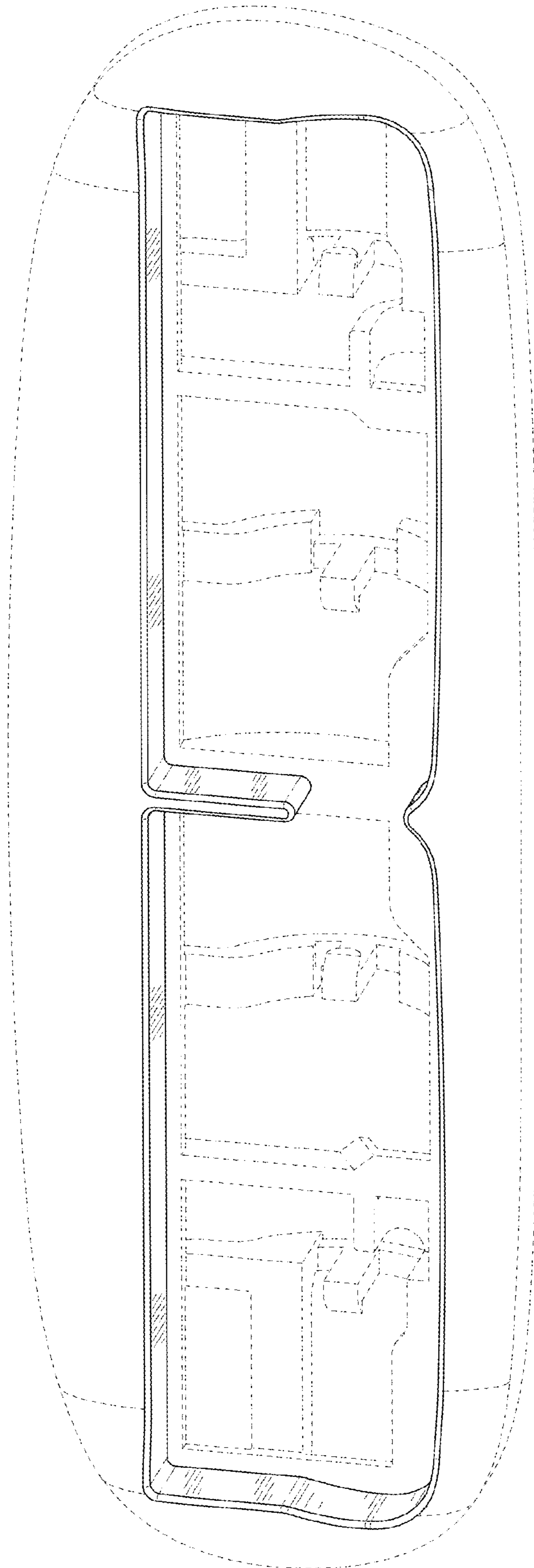

FIG. 1

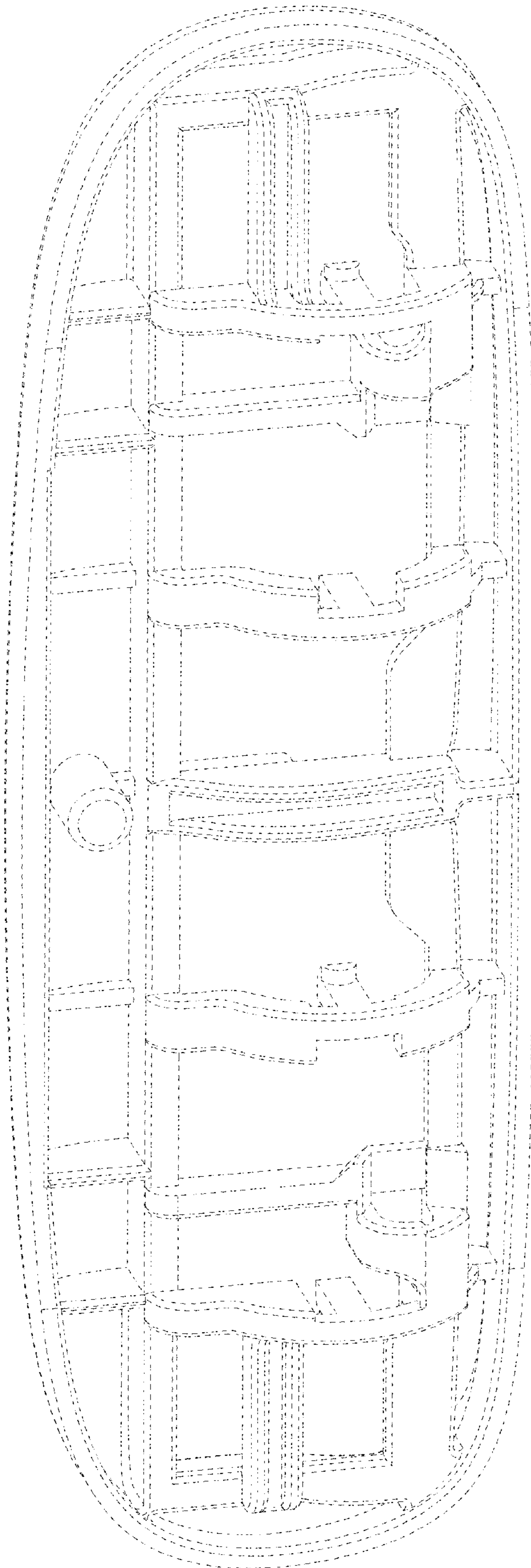

FIG. 2

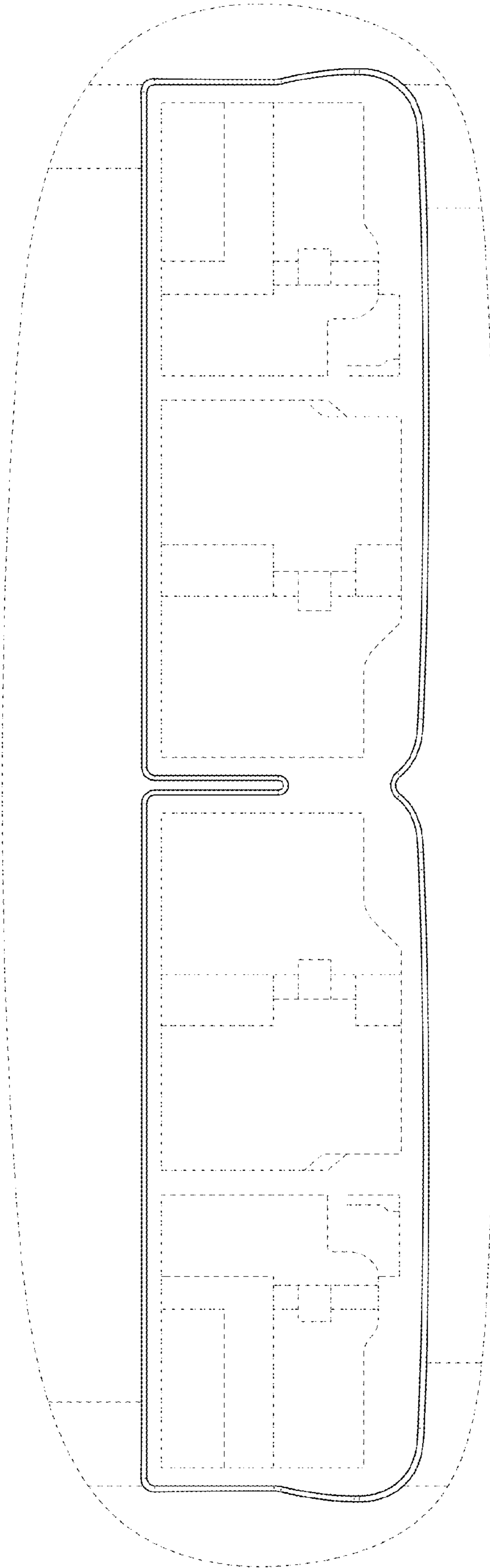

FIG. 3

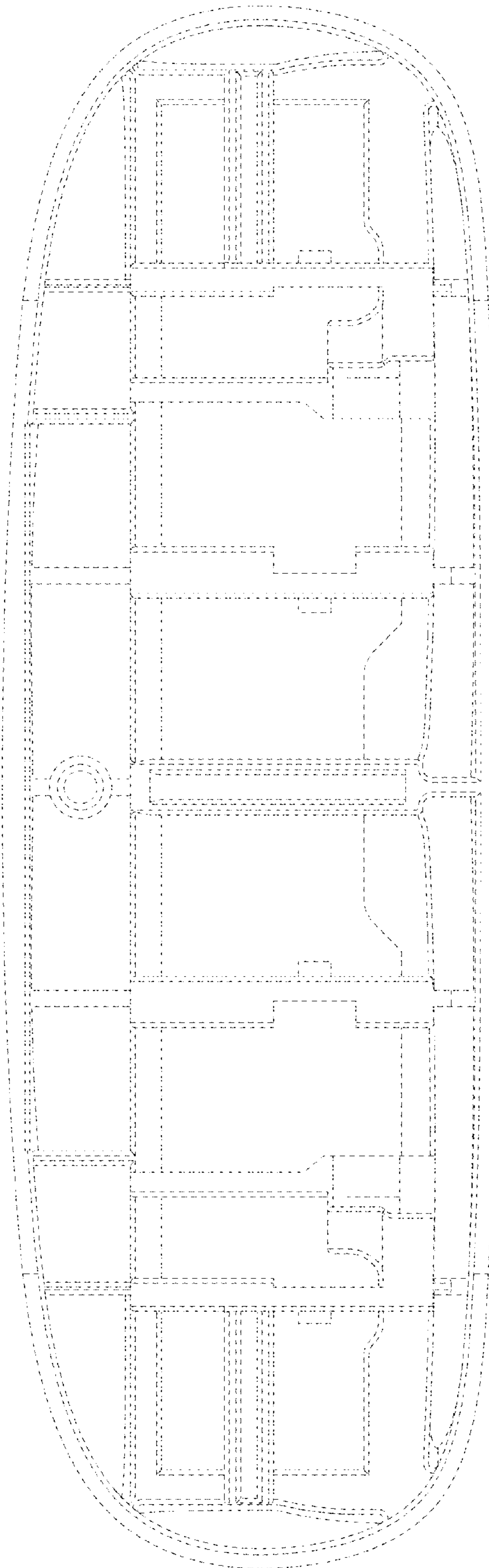

FIG. 4

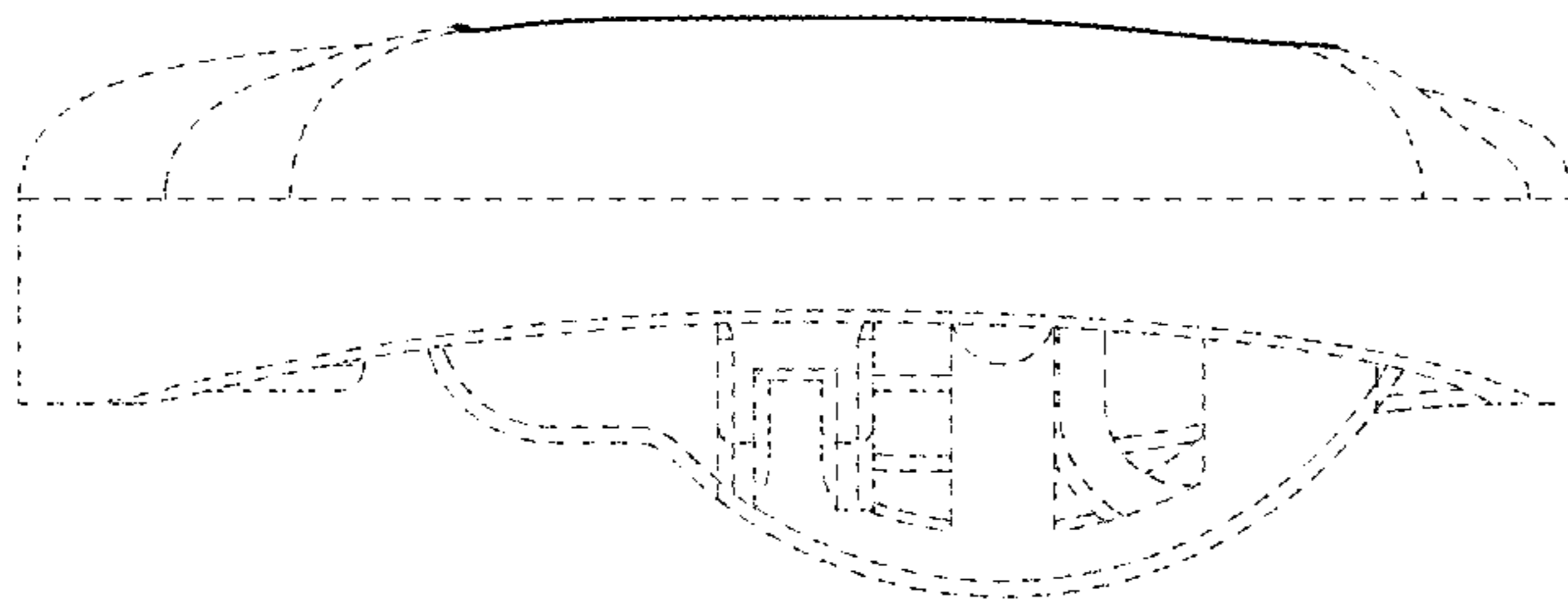

FIG. 5

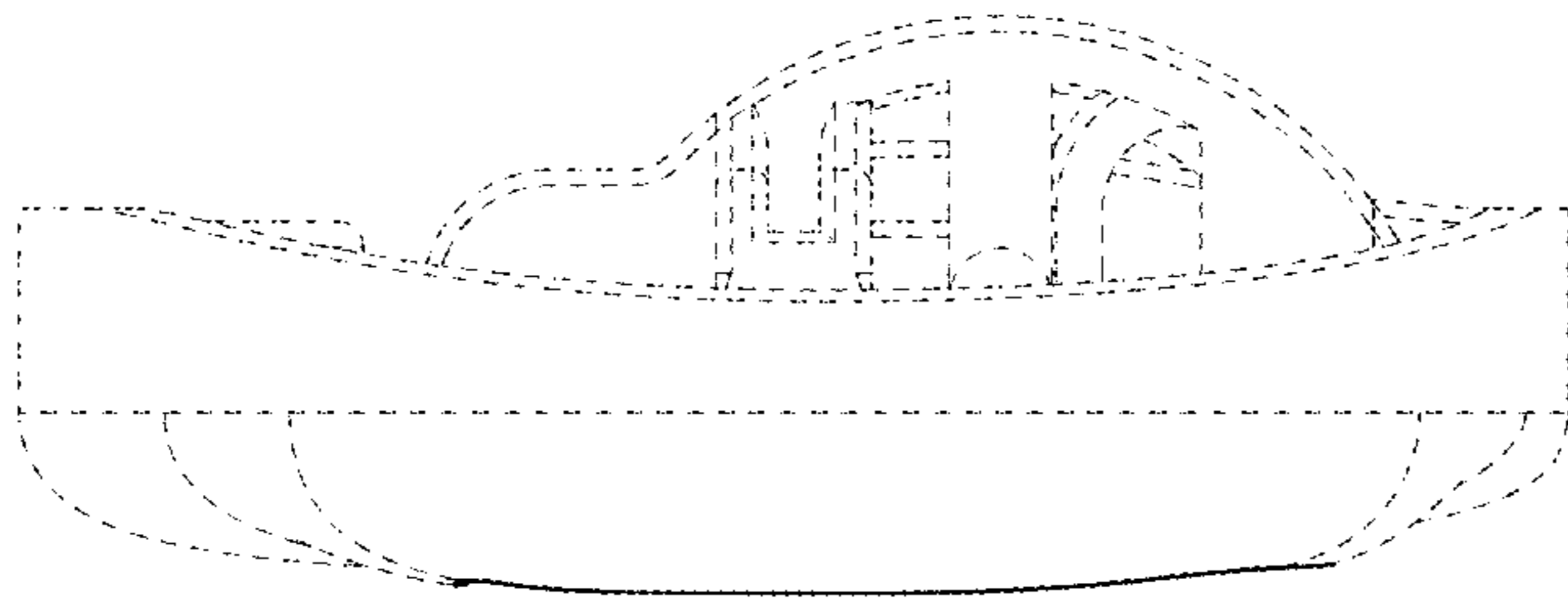

FIG. 6

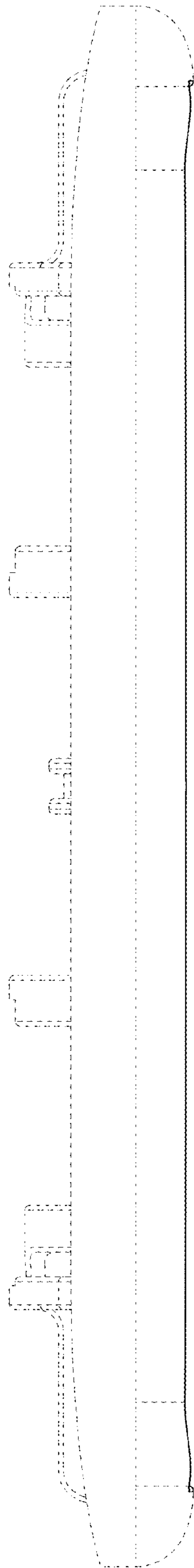

FIG. 7

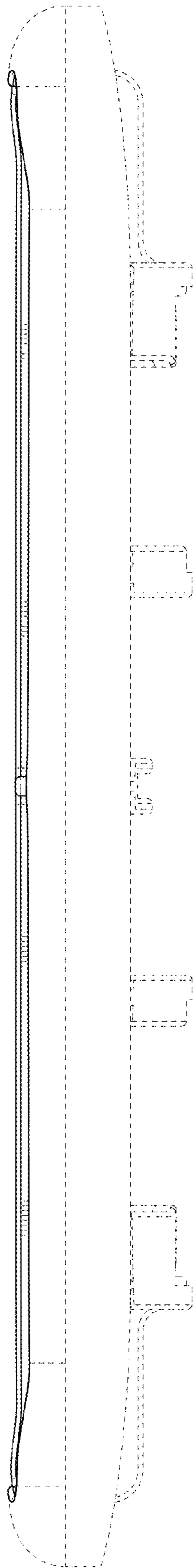

FIG. 8

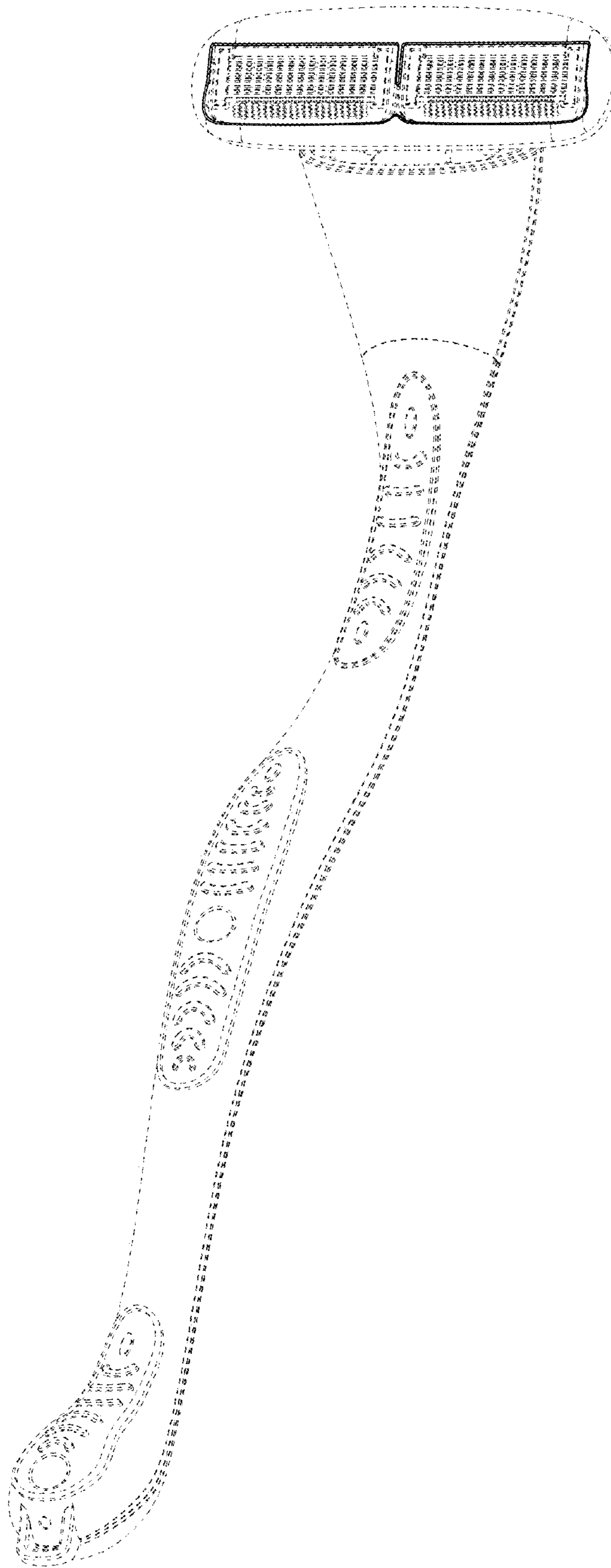

FIG. 9