



US00D987148S

(12) **United States Design Patent** (10) **Patent No.:** **US D987,148 S**
Wu (45) **Date of Patent:** **** May 23, 2023**

(54) **LAMP**

FOREIGN PATENT DOCUMENTS

(71) Applicant: **Nanchang Yunzhao Technology Co., Ltd.**, Nanchang (CN)

EM 008634000-0001 * 8/2021

(72) Inventor: **Zijian Wu**, Shangrao (CN)

OTHER PUBLICATIONS

(73) Assignee: **Nanchang Yunzhao Technology Co., Ltd.**, Nanchang (CN)

“Qisemdum” reference by Qisemdum on Amazon.com, first date available Jun. 29, 2021 [online], site visited Aug. 11, 2022, available from internet URL: <https://www.amazon.com/Krista-Workbench-Gooseneck-Drafting-Function/dp/B09872QWJK> (Year: 2021).*

(**) Term: **15 Years**

“Ring” reference by Acetaken Mount on Amazon.com, date first available Aug. 1, 2018 [online], site visited Aug. 11, 2022, available from internet URL: <https://www.amazon.com/Gooseneck-Streaming-Architect-Drafting-Workbench/dp/B087CF4BGH> (Year: 2018).*

(21) Appl. No.: **29/801,697**

(22) Filed: **Jul. 30, 2021**

* cited by examiner

(51) **LOC (14) Cl.** **26-05**

(52) **U.S. Cl.**
USPC **D26/60**

(58) **Field of Classification Search**
USPC D26/24, 37, 43, 60–63, 64, 65, 93, 102
CPC F21K 9/00; F21K 9/20; F21L 4/00; F21L 4/005; F21L 4/06; F21S 9/00; F21S 9/02; F21V 21/042; F21V 21/08; F21V 21/088
See application file for complete search history.

Primary Examiner — Richard Kearney

Assistant Examiner — Liv C Anderson

(74) *Attorney, Agent, or Firm* — Charney IP Law LLC; Thomas M. Finetti

(56) **References Cited**

U.S. PATENT DOCUMENTS

D487,813 S * 3/2004 Sherman D26/65
D538,830 S * 3/2007 Yip D26/62
D597,239 S * 7/2009 Hodgson D26/65
D644,368 S * 8/2011 Fu D26/65
D669,626 S * 10/2012 Huang D26/107
D732,217 S * 6/2015 Wiedenmann D26/60
D776,317 S * 1/2017 Li D26/62
D855,871 S * 8/2019 Ma D26/107
D860,496 S * 9/2019 Waldmann D26/65
D871,648 S * 12/2019 Tong D26/107
D963,223 S * 9/2022 Qian D26/60
D965,837 S * 10/2022 Xu D26/63
D967,483 S * 10/2022 Wu D26/62
D971,474 S * 11/2022 Sun D26/63

(57) **CLAIM**

The ornamental design for a lamp, as shown and described.

DESCRIPTION

FIG. 1 is a perspective view of a lamp showing my new design;
FIG. 2 is a front elevational view thereof;
FIG. 3 is a rear elevational view thereof;
FIG. 4 is a left side view thereof;
FIG. 5 is a right side view thereof;
FIG. 6 is a top plan view thereof; and,
FIG. 7 is a bottom plan view thereof.
The broken lines depict portions of the lamp that form no part of the claimed design.

1 Claim, 7 Drawing Sheets

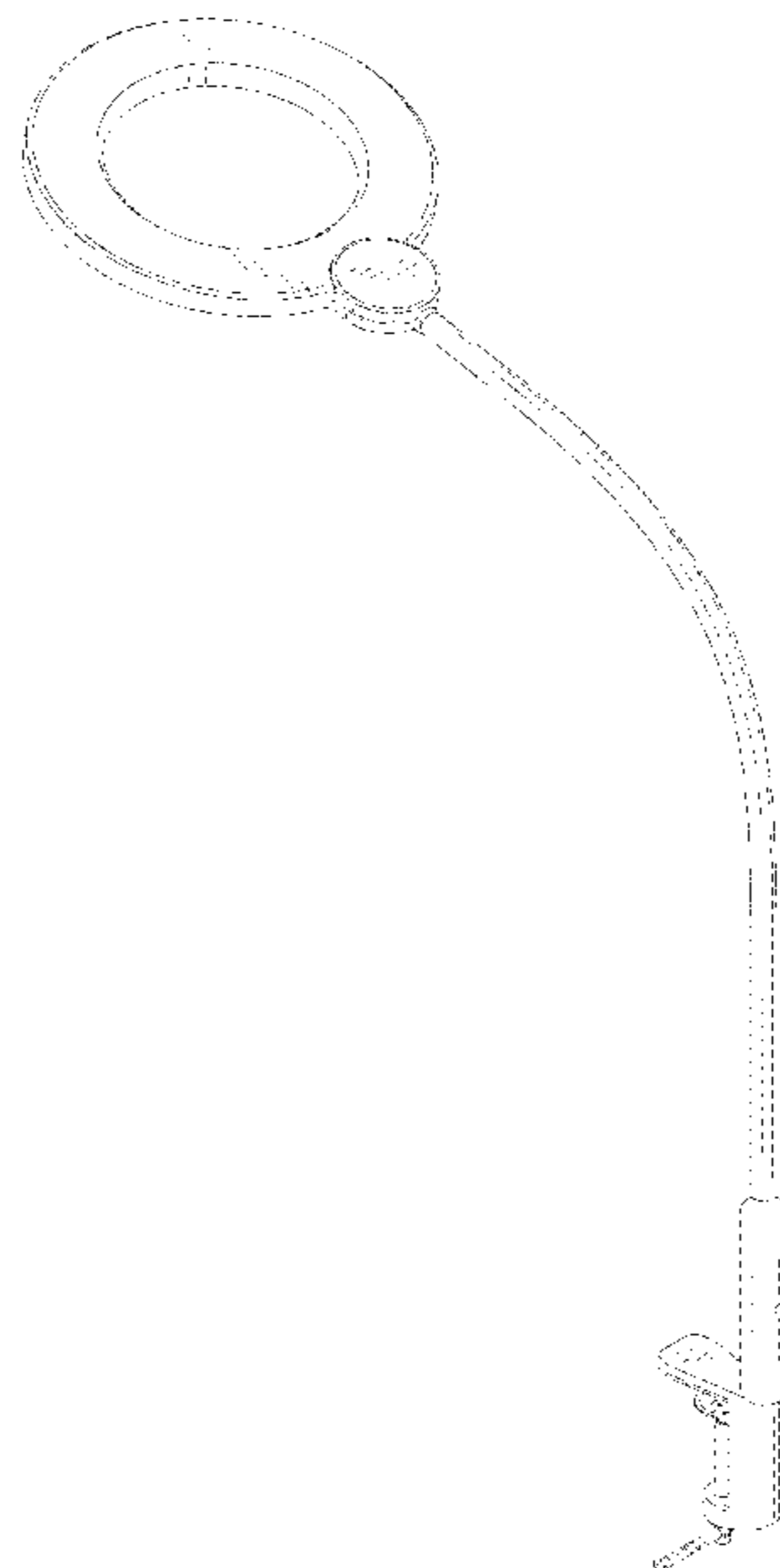



Fig. 1

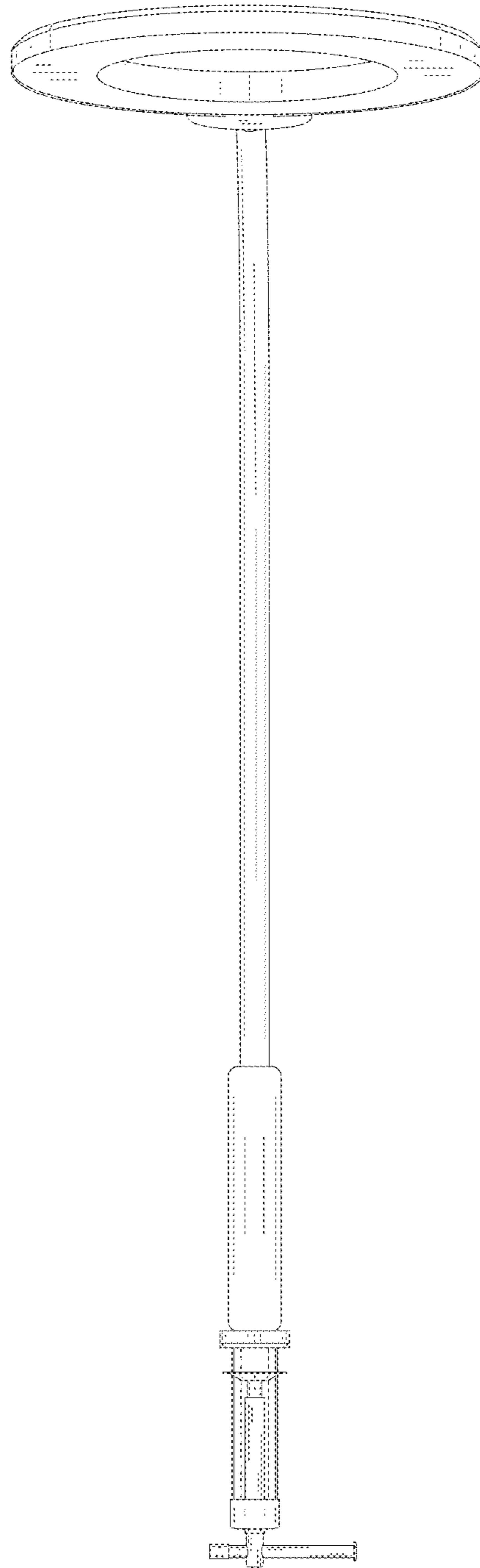

Fig.2

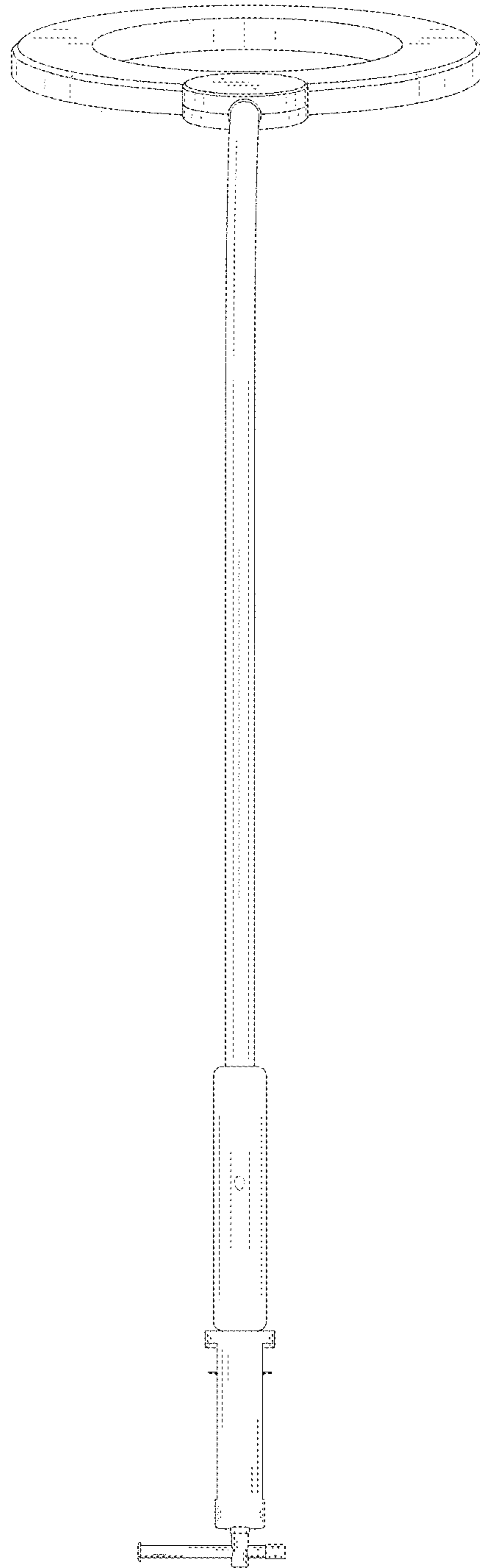

Fig.3

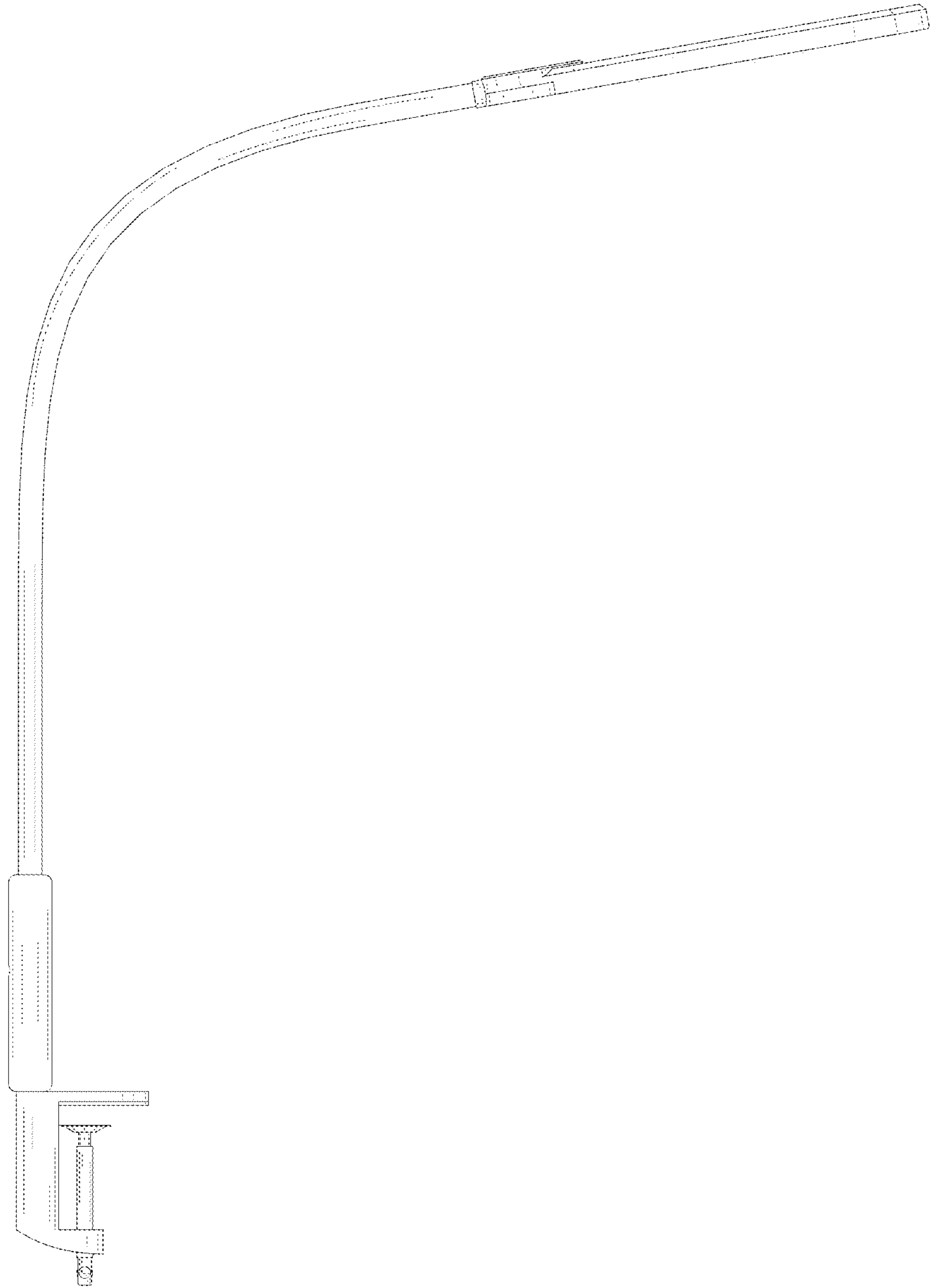

Fig.4

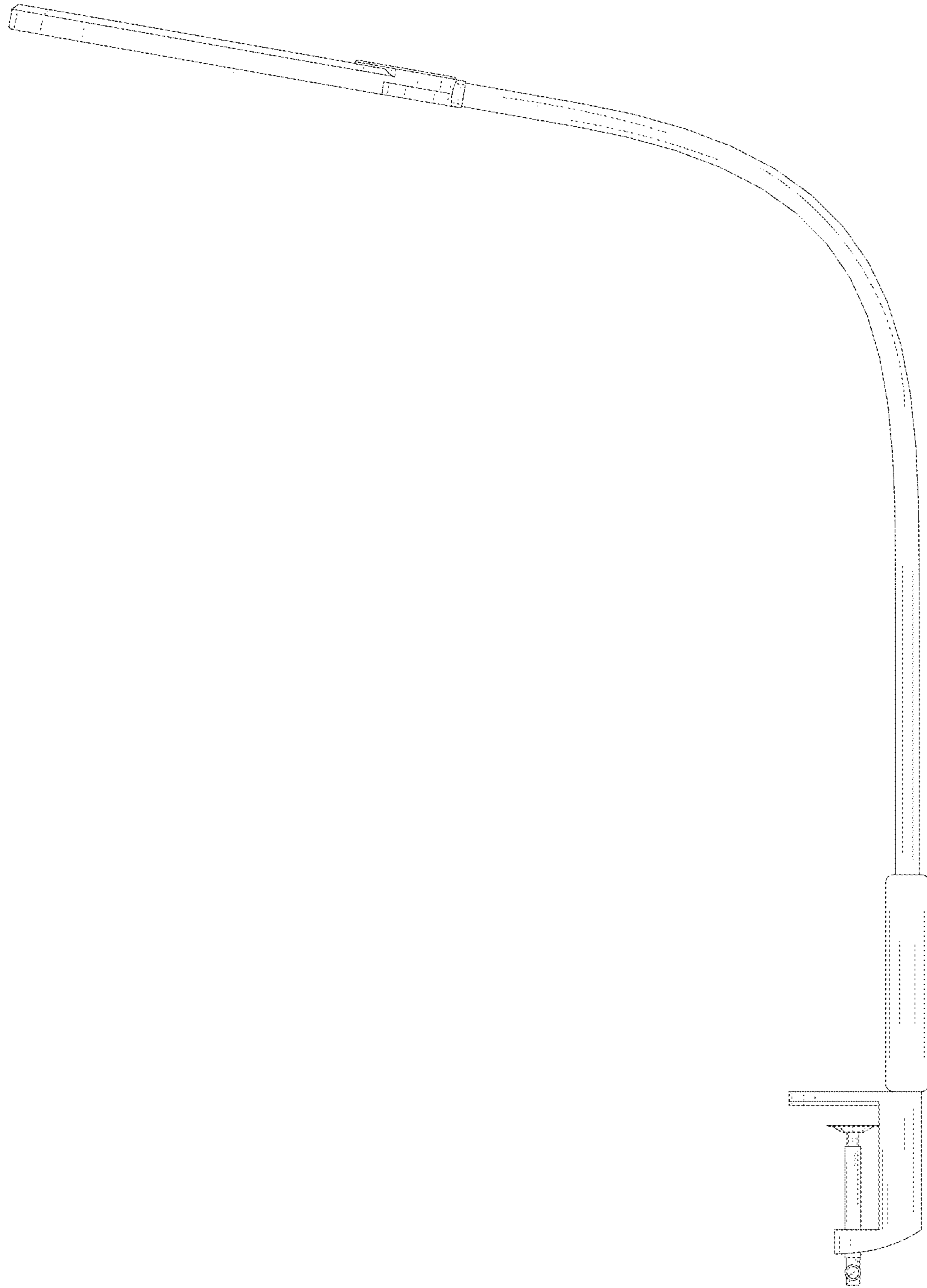

Fig. 5

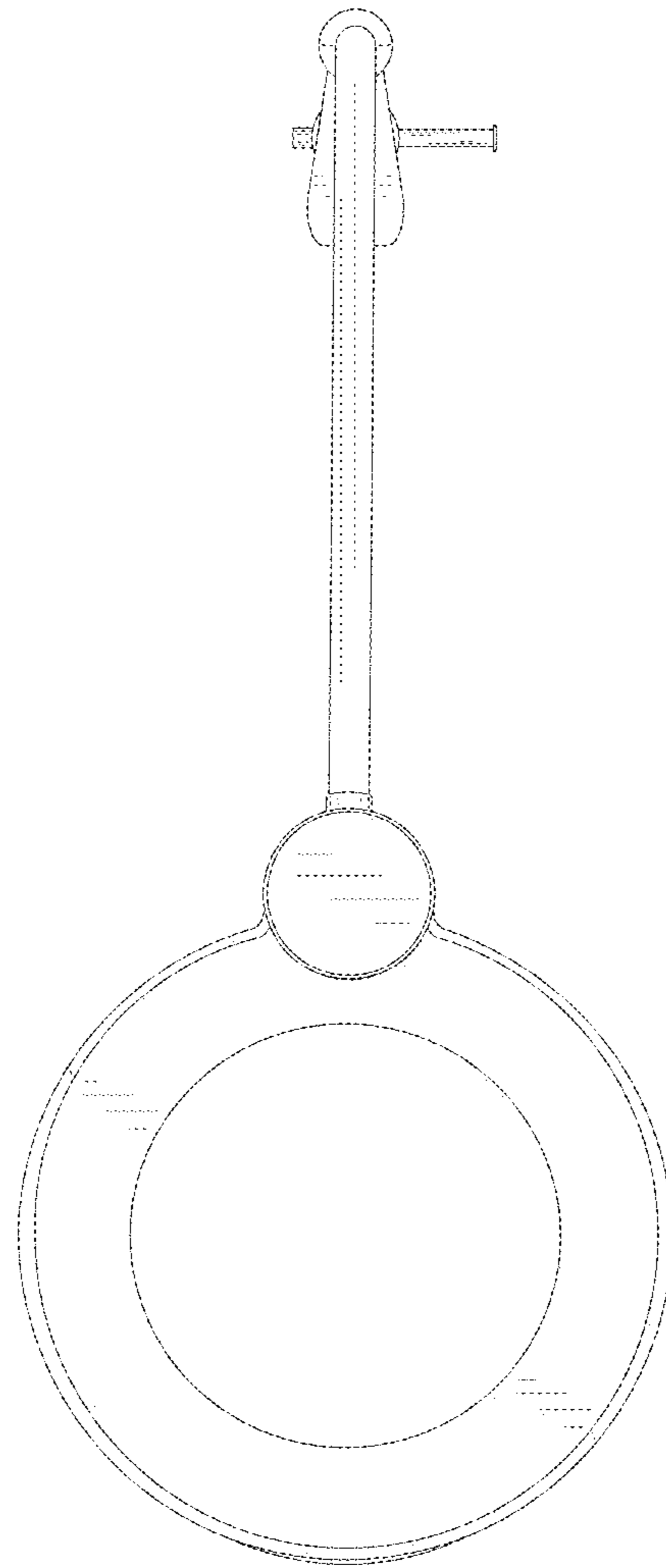

Fig. 6

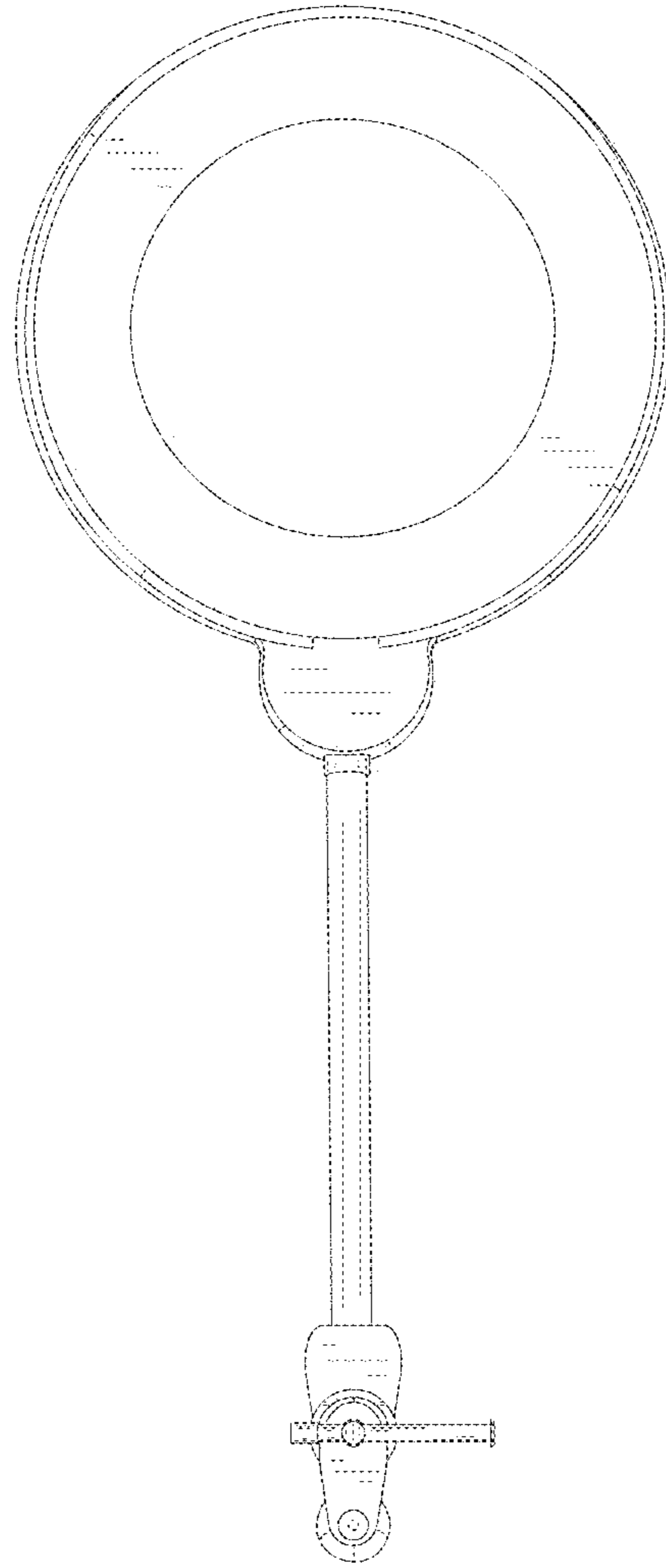

Fig. 7