



US00D987069S

(12) **United States Design Patent**
Wang

(10) **Patent No.:** **US D987,069 S**

(45) **Date of Patent:** **** May 23, 2023**

- (54) **FACE MASK**
- (71) Applicant: **Razer (Asia-Pacific) Pte. Ltd.**,
Singapore (SG)
- (72) Inventor: **Eugene Hanjie Wang**, Singapore (SG)
- (73) Assignee: **RAZER (ASIA-PACIFIC) PTE. LTD.**,
Singapore (SG)
- (**) Term: **15 Years**
- (21) Appl. No.: **29/799,483**
- (22) Filed: **Jul. 14, 2021**
- (51) **LOC (14) Cl.** **29-02**
- (52) **U.S. Cl.**
USPC **D24/110.1; D29/108**
- (58) **Field of Classification Search**
USPC **D24/110-110.6; D29/108**
CPC . **A41D 13/11; A41D 13/1107; A41D 13/1115;**
A41D 13/1123; A41D 13/113; A41D
13/1138; A41D 13/1146; A41D 13/1153;
A41D 13/1161; A41D 13/1169; A41D
13/1176; A41D 13/1184; A61M 16/06;
A62B 18/00; A62B 18/02; A62B 18/025;
A62B 23/00
See application file for complete search history.

D764,656 S *	8/2016	Skov	D24/110.1
D795,416 S *	8/2017	Blomberg	D24/110.1
9,993,668 B2 *	6/2018	Gerson	A62B 7/10
D890,916 S *	7/2020	Castiglione	D24/110.2
D963,157 S *	9/2022	Kim	D29/108
D968,031 S *	10/2022	Hatzlhoffer	A62B 18/08
				D29/108
2004/0055604 A1 *	3/2004	Viner	A62B 23/02
				128/206.16
2005/0211251 A1 *	9/2005	Henderson	A62B 18/025
				128/206.27
2021/0378326 A1 *	12/2021	Choi	A62B 18/08
2022/0072345 A1 *	3/2022	Viles	B01D 46/58

* cited by examiner

Primary Examiner — Richard Kearney
Assistant Examiner — Michael Hoffman
(74) *Attorney, Agent, or Firm* — Polsinelli

(57) **CLAIM**

I claim the ornamental design for a face mask, as shown and described.

DESCRIPTION

FIG. 1 is a perspective view of a face mask, showing my new design;
FIG. 2 is a front elevational view thereof;
FIG. 3 is a rear elevational view thereof;
FIG. 4 is a right side elevational view thereof;
FIG. 5 is a left side elevational view thereof;
FIG. 6 is a top plan view thereof; and,
FIG. 7 is a bottom plan view thereof.
The broken lines shown in the drawings illustrate portions of the face mask and form no part of the claimed design.

1 Claim, 6 Drawing Sheets

(56) **References Cited**

U.S. PATENT DOCUMENTS

D518,571 S *	4/2006	Martin	D24/110.1
D541,413 S *	4/2007	Jarvinen	D24/110.1
D677,780 S *	3/2013	Choi	D24/110.1

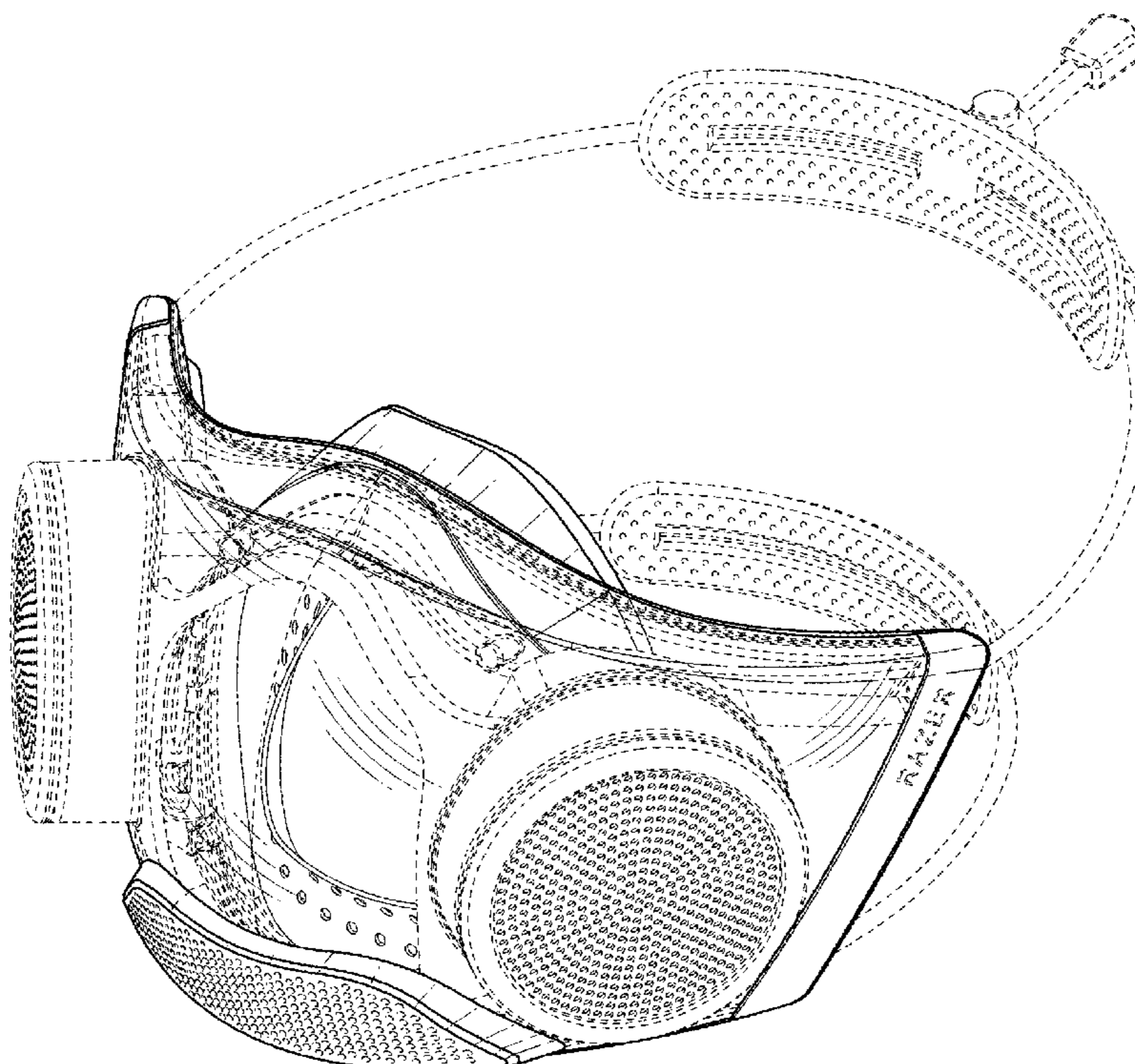

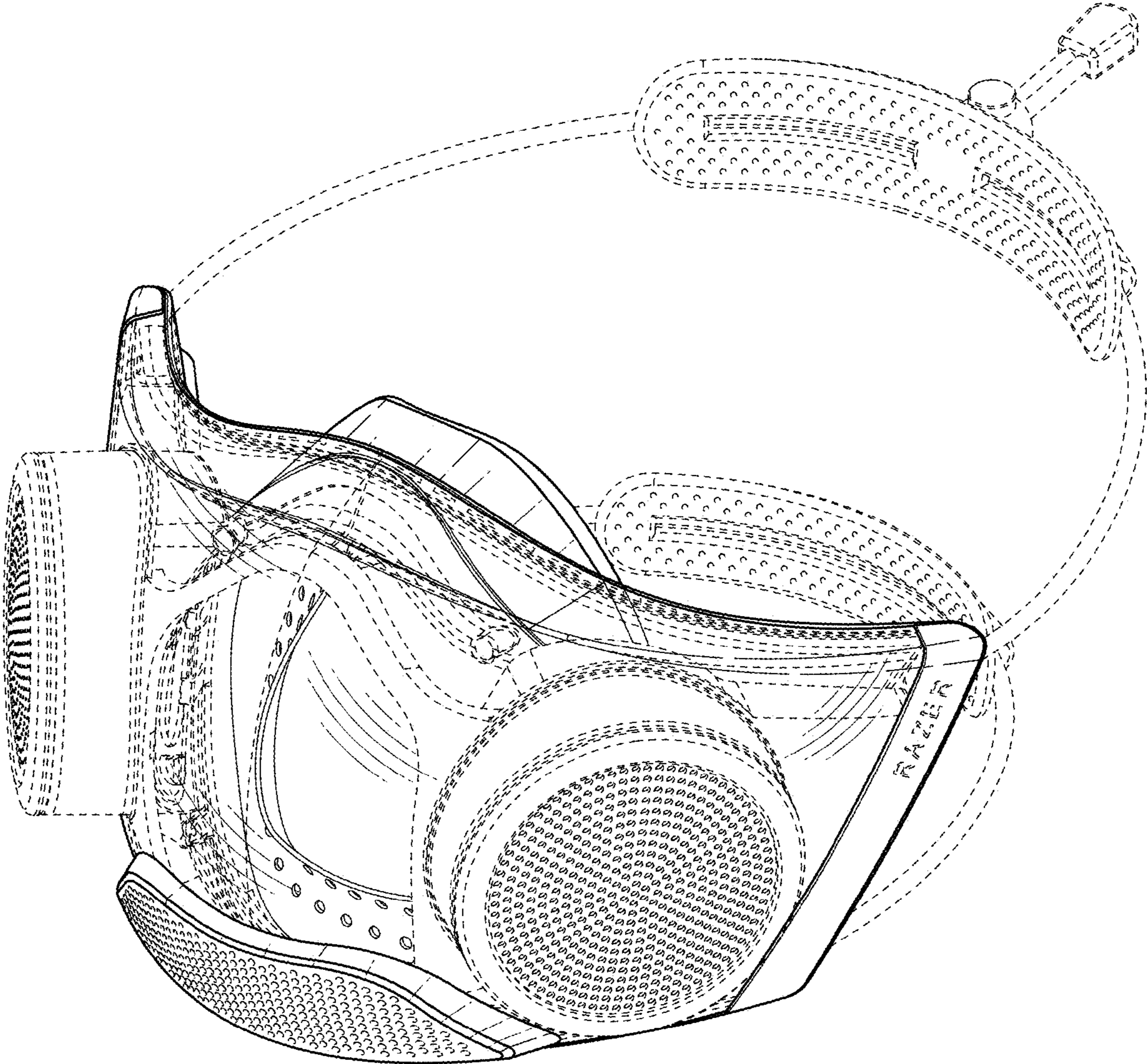

FIG. 1

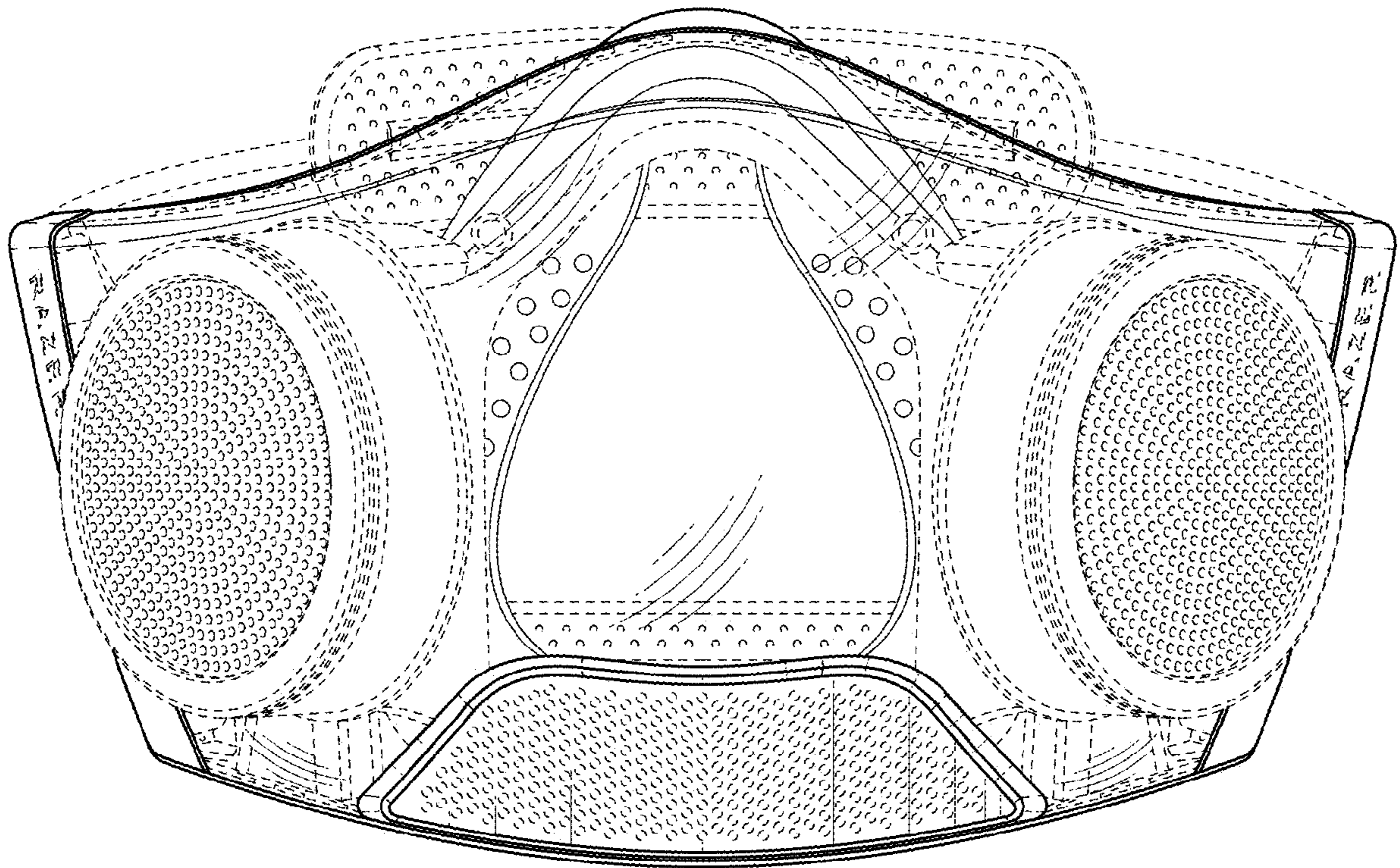

FIG. 2

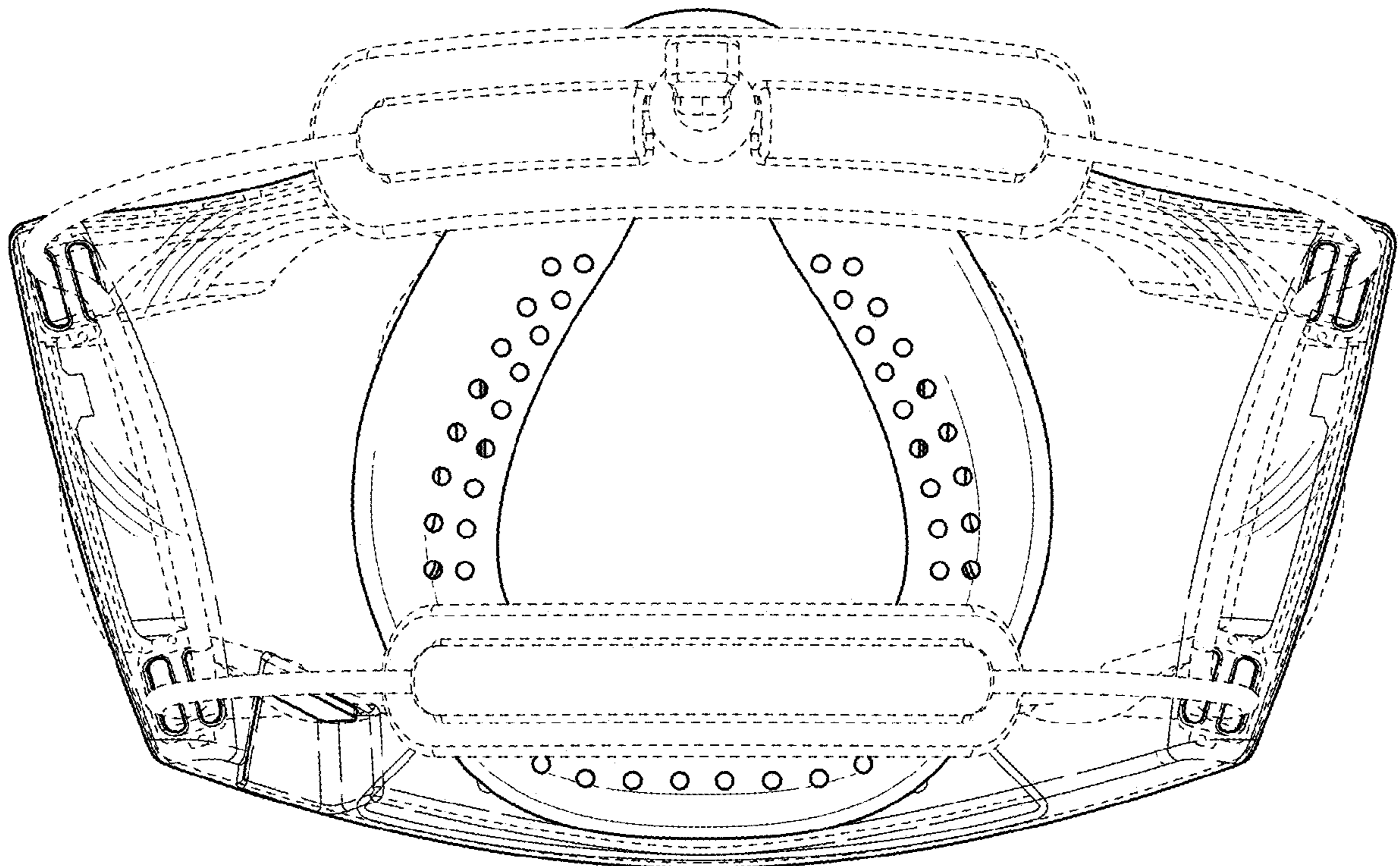

FIG. 3

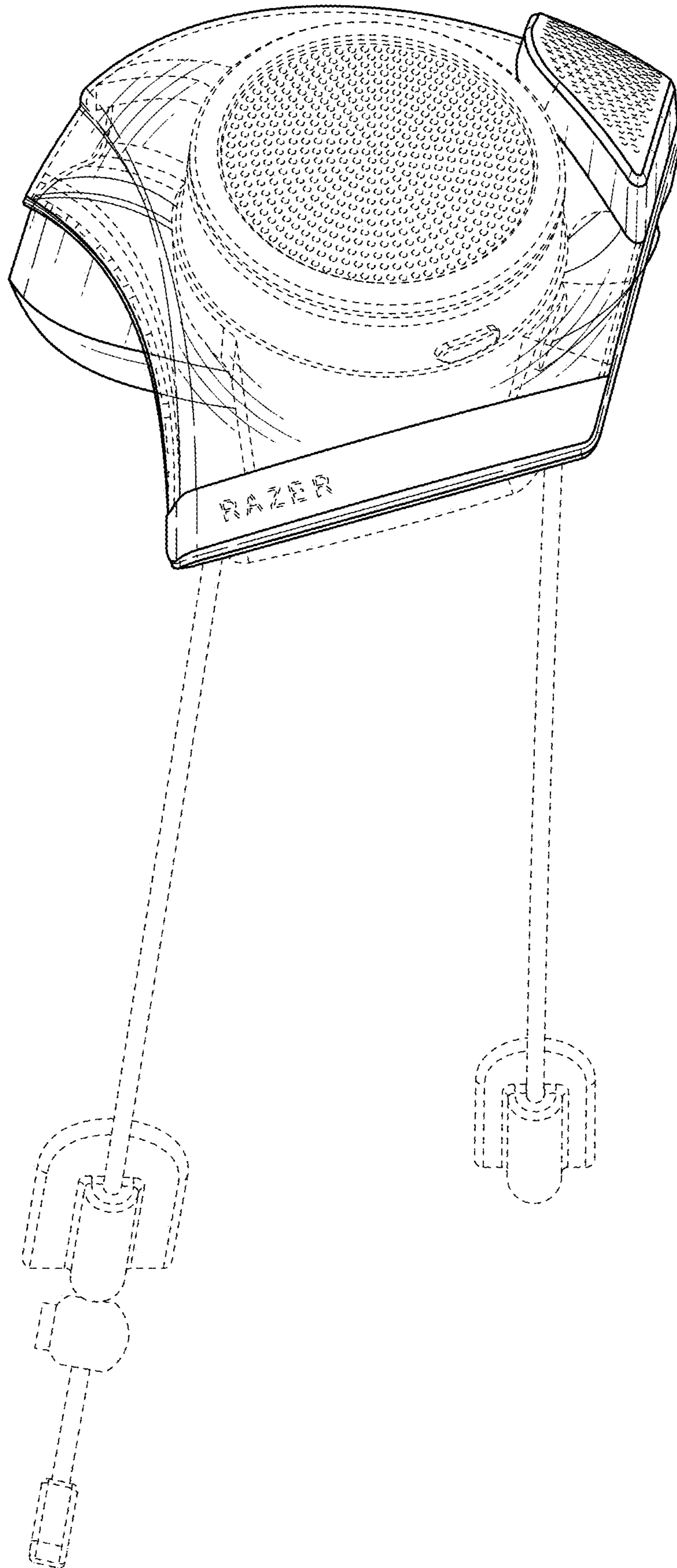

FIG. 4

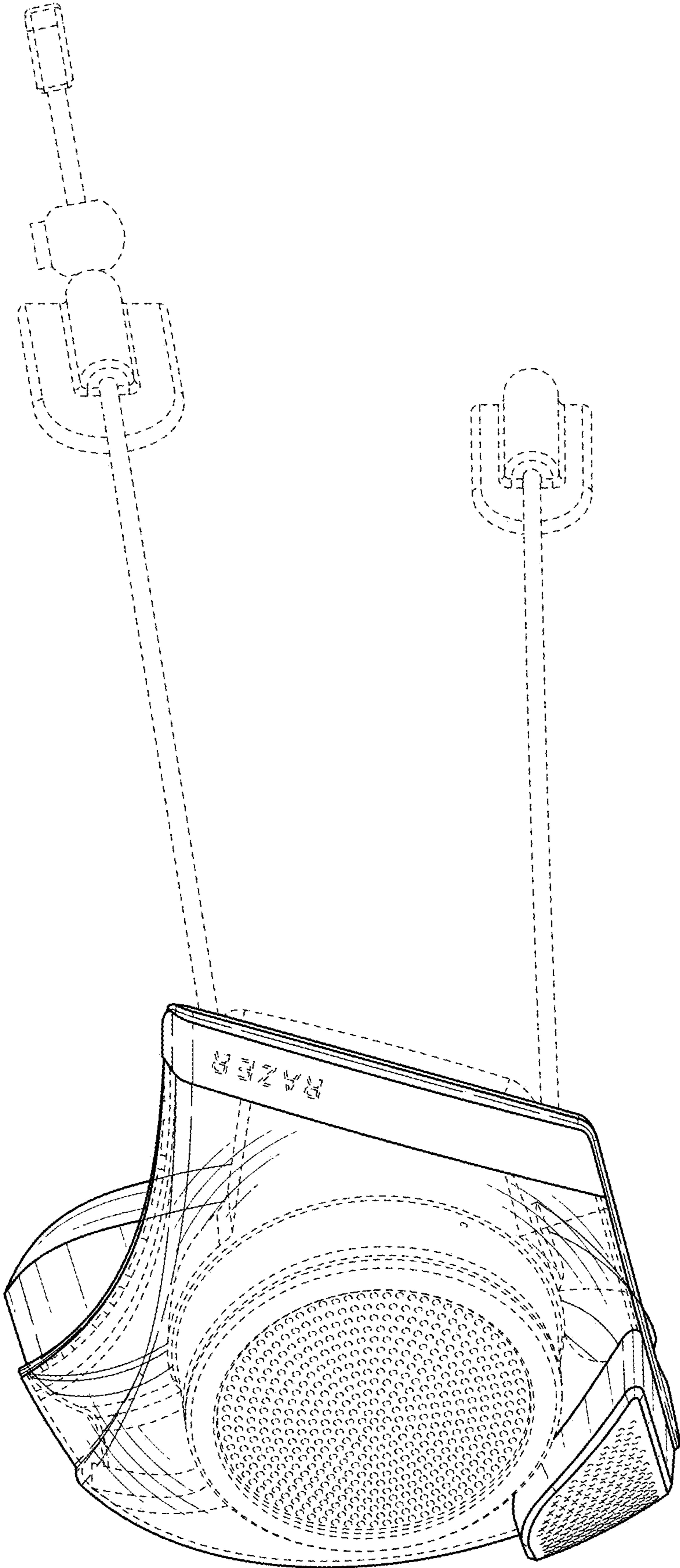

FIG. 5

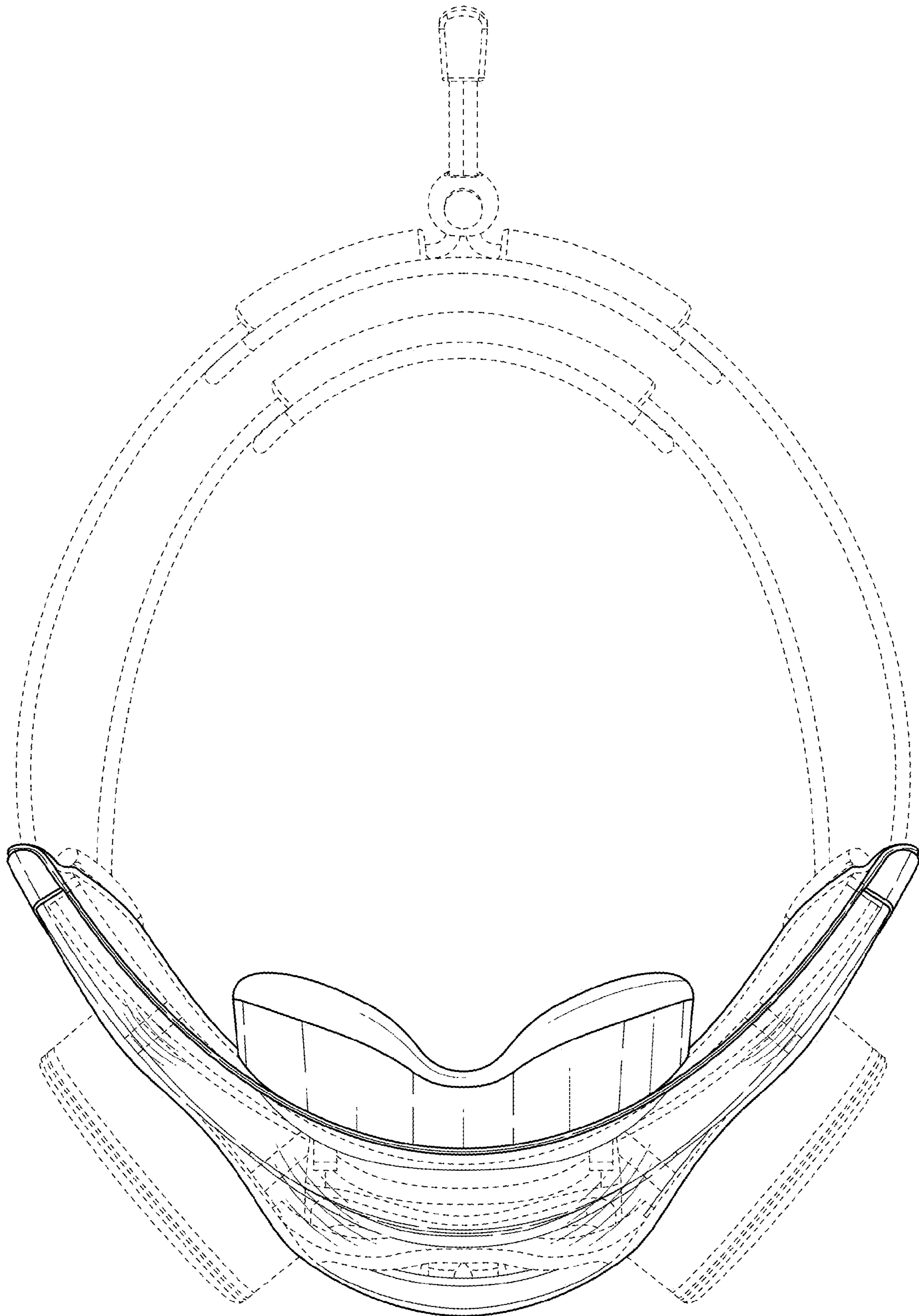

FIG. 6

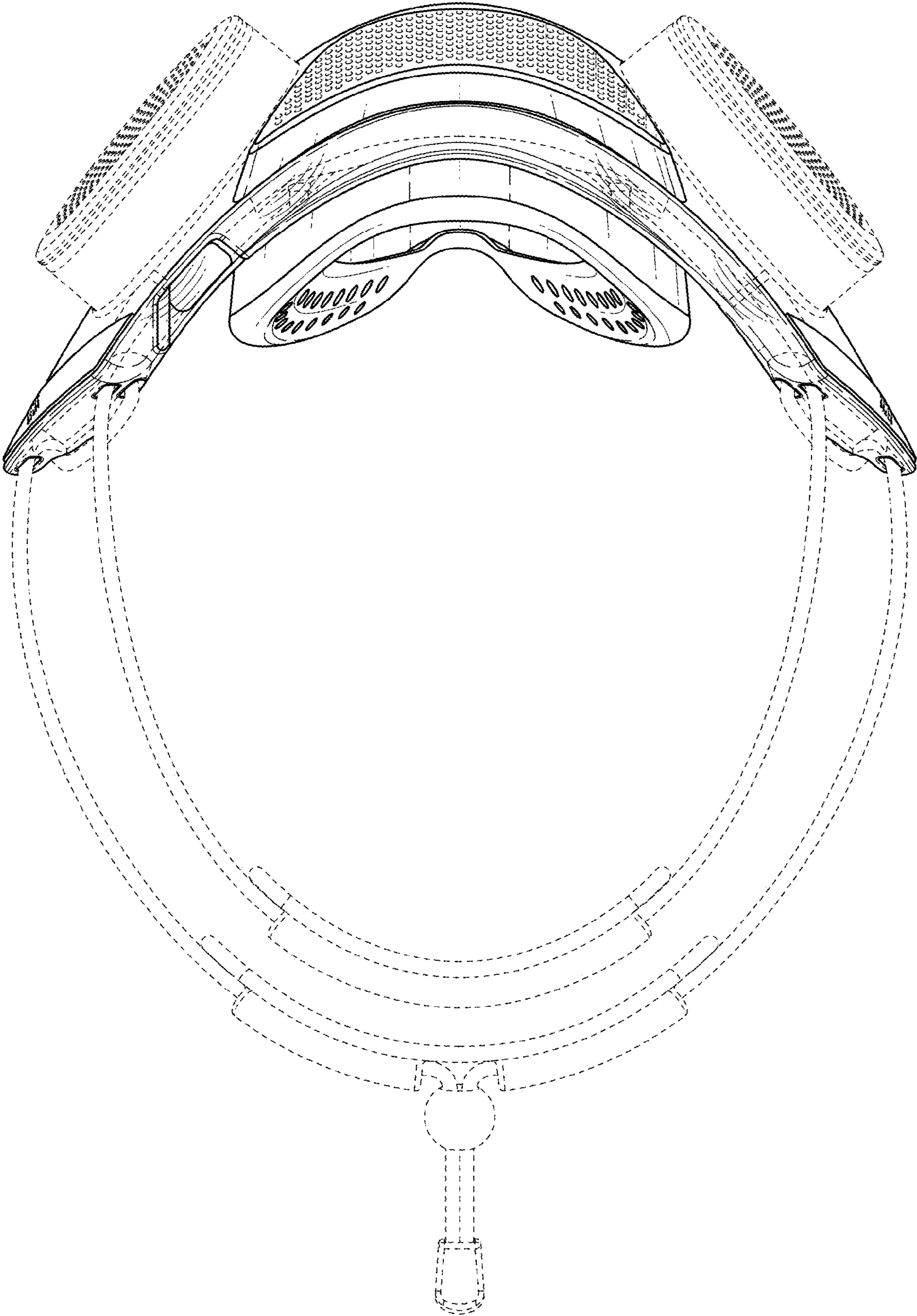

FIG. 7