



US00D986999S

(12) **United States Design Patent**
Andrews

(10) **Patent No.:** **US D986,999 S**
(45) **Date of Patent:** **** May 23, 2023**

(54) **GOLF CLUB HEAD**

(71) Applicant: **PARSONS XTREME GOLF, LLC**,
Scottsdale, AZ (US)

(72) Inventor: **Matthew T. Andrews**, Scottsdale, AZ
(US)

(73) Assignee: **PARSONS XTREME GOLF, LLC**,
Scottsdale, AZ (US)

(**) Term: **15 Years**

(21) Appl. No.: **29/799,571**

(22) Filed: **Jul. 15, 2021**

Related U.S. Application Data

(60) Division of application No. 29/713,443, filed on Nov. 15, 2019, now Pat. No. Des. 928,259, which is a continuation-in-part of application No. 29/710,168, filed on Oct. 21, 2019, now abandoned.

(51) **LOC (14) Cl.** **21-02**

(52) **U.S. Cl.**
USPC **D21/736**

(58) **Field of Classification Search**
USPC D21/736-746, 759
CPC A63B 53/00; A63B 53/04; A63B 53/007;
A63B 53/065; A63B 53/0487; A63B
60/00; A63B 60/46
See application file for complete search history.

(56) **References Cited**

U.S. PATENT DOCUMENTS

723,534 A	3/1903	Knight
922,444 A	5/1909	Youds
1,094,599 A	4/1914	Samson
D57,980 S	5/1921	Kraeuter
D63,284 S	11/1923	Challis
RE19,178 E	5/1934	Spiker

4,043,562 A	8/1977	Shillington
D248,783 S	8/1978	Long
4,340,230 A	7/1982	Churchward
D281,092 S	10/1985	Mills
4,754,977 A	7/1988	Sahm
4,869,507 A	9/1989	Sahm

(Continued)

FOREIGN PATENT DOCUMENTS

JP	2004223184 A	8/2004
JP	2005160691 A	6/2005

(Continued)

OTHER PUBLICATIONS

Golf putters google search; google.com; Jan. 6, 2023.*

(Continued)

Primary Examiner — Mitchell I. Siegel

(57) **CLAIM**

The ornamental design for a golf club head, as shown and described.

DESCRIPTION

FIG. 1 is a top perspective view of a golf club head; FIG. 2 is a bottom perspective view of the golf club head of FIG. 1; FIG. 3 is a front elevational view of the golf club head of FIG. 1; FIG. 4 is a rear elevational view of the golf club head of FIG. 1; FIG. 5 is a top view of the golf club head of FIG. 1; FIG. 6 is a bottom view of the golf club head of FIG. 1; FIG. 7 is a left side view of the golf club head of FIG. 1; and, FIG. 8 is a right side view of the golf club head of FIG. 1. The broken lines shown on the drawings form no part of the claimed design.

1 Claim, 4 Drawing Sheets

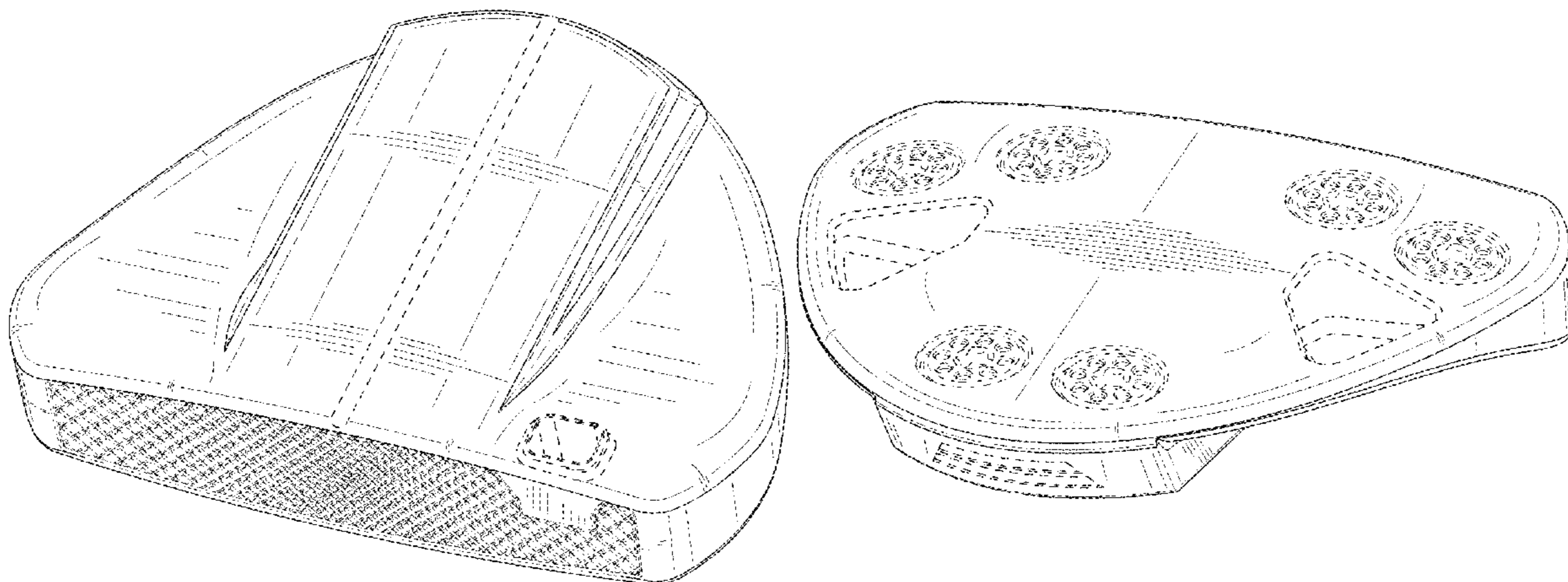

US D986,999 S

(56)

References Cited

U.S. PATENT DOCUMENTS

4,964,641	A	10/1990	Miesch et al.	D498,276	S	11/2004	Schweigert et al.	
D313,451	S	1/1991	Shearer	D500,823	S	* 1/2005	Aldrich	D21/759
D335,317	S	5/1993	Shearer	6,902,496	B2	6/2005	Solheim et al.	
D335,692	S	5/1993	Antonious	6,902,498	B2	6/2005	Sullivan et al.	
D336,757	S	6/1993	Antonious	D511,801	S	11/2005	Garcia	
5,275,412	A	1/1994	Innes	D512,114	S	11/2005	Garcia	
D350,582	S	9/1994	Miansian et al.	D512,116	S	11/2005	Miraflor et al.	
5,390,919	A	2/1995	Stubbs et al.	6,988,955	B2	1/2006	Stoakes	
D356,131	S	3/1995	Trimble	6,988,956	B2	1/2006	Cover et al.	
D360,444	S	7/1995	Takahashi et al.	D520,088	S	5/2006	Parr	
5,429,366	A	7/1995	McCabe	D531,242	S	10/2006	Adams	
D363,101	S	10/1995	Sturm	7,125,341	B1	10/2006	D'Eath	
D364,665	S	11/1995	Goodrich	D532,067	S	11/2006	Soracco et al.	
D365,864	S	1/1996	Sturm	7,153,220	B2	12/2006	Lo	
5,489,097	A	2/1996	Simmons	D534,595	S	1/2007	Hasebe	
D368,751	S	4/1996	Rife	7,156,752	B1	1/2007	Bennett	
D369,393	S	4/1996	Takahashi et al.	D536,401	S	2/2007	Kawami	
5,571,053	A	11/1996	Lane	D536,403	S	2/2007	Kawami	
D378,688	S	4/1997	Cameron	D537,898	S	3/2007	Kuan et al.	
D380,514	S	7/1997	Markley	D538,371	S	3/2007	Kawami	
D385,609	S	10/1997	Cameron	7,204,765	B2	4/2007	Cover et al.	
5,683,307	A	11/1997	Rife	D542,869	S	5/2007	Adams	
D388,143	S	12/1997	Huan-Chiang	D543,598	S	5/2007	Kuan et al.	
D389,207	S	1/1998	Cameron	D543,601	S	5/2007	Kawami	
D398,685	S	9/1998	Masuda	D555,219	S	11/2007	Lin	
5,807,190	A	9/1998	Krumme et al.	D556,277	S	11/2007	Broom	
D399,290	S	10/1998	Sizemore, Jr.	7,309,297	B1	12/2007	Solari	
D399,911	S	10/1998	Nicolette et al.	D561,854	S	2/2008	Morris	
5,839,974	A	11/1998	McAllister	7,331,876	B2	2/2008	Klein	
D405,836	S	2/1999	Nicolette et al.	7,351,162	B2	4/2008	Soracco et al.	
D409,701	S	5/1999	Ashcraft et al.	D569,460	S	* 5/2008	Walker	D21/743
D411,275	S	6/1999	Bottema et al.	D569,461	S	5/2008	Morris	
5,924,938	A	7/1999	Hines	D569,930	S	5/2008	Nehrbas	
D415,809	S	10/1999	Bottema et al.	D574,050	S	* 7/2008	Jones	D21/759
D416,062	S	11/1999	Solheim et al.	7,396,289	B2	7/2008	Soracco et al.	
D416,969	S	11/1999	Solheim et al.	D577,085	S	9/2008	Nicolette et al.	
D416,970	S	11/1999	Solheim et al.	D577,086	S	9/2008	Nicolette et al.	
6,007,434	A	12/1999	Baker et al.	D579,506	S	10/2008	Nicolette et al.	
D421,473	S	3/2000	Solheim et al.	D579,995	S	11/2008	Nicolette et al.	
D422,655	S	4/2000	Hicks	D582,497	S	12/2008	Rollinson	
6,050,903	A	4/2000	Lake	7,473,189	B2	1/2009	Schweigert et al.	
D426,276	S	6/2000	Besnard et al.	7,491,131	B2	2/2009	Minton	
6,089,993	A	7/2000	Woodward et al.	D594,921	S	6/2009	Bettinardi	
D429,302	S	8/2000	Antonious	D595,793	S	7/2009	Rollinson	
6,110,057	A	8/2000	McKinnon	D599,425	S	9/2009	Laub	
D430,914	S	9/2000	Antonious	D599,867	S	9/2009	Teramoto	
D431,853	S	10/2000	Antonious	D600,763	S	9/2009	Cameron	
D431,854	S	10/2000	Cameron	D601,214	S	9/2009	Serrano et al.	
D432,192	S	10/2000	Hicks	D607,951	S	1/2010	Teramoto	
D436,151	S	1/2001	Nicolette et al.	7,744,485	B2	6/2010	Jones et al.	
D437,374	S	2/2001	Cameron	D620,993	S	8/2010	Laub	
D441,820	S	5/2001	Nicolette et al.	D621,461	S	8/2010	Serrano et al.	
D443,668	S	6/2001	Nicolette et al.	D623,709	S	9/2010	Serrano et al.	
D443,905	S	6/2001	Nicolette et al.	D631,925	S	2/2011	Broom	
D444,833	S	7/2001	Wells et al.	7,887,432	B2	2/2011	Jones et al.	
D444,835	S	7/2001	Wahl et al.	D633,964	S	3/2011	Teramoto	
6,257,994	B1	7/2001	Antonious	7,909,707	B2	3/2011	Klein	
6,264,571	B1	7/2001	Lekavich	7,918,745	B2	4/2011	Morris et al.	
D449,664	S	10/2001	Beebe et al.	7,927,226	B1	4/2011	Twitty	
D449,865	S	10/2001	Fife, Jr. et al.	D638,891	S	5/2011	Nicolette et al.	
D450,799	S	11/2001	Nicolette et al.	7,942,758	B2	5/2011	Nakamura	
D451,973	S	12/2001	Wells et al.	D639,369	S	6/2011	Miyamichi	
6,348,014	B1	2/2002	Chiu	D642,643	S	8/2011	Nicolette et al.	
6,354,959	B1	3/2002	Nicolette et al.	D643,485	S	8/2011	Nicolette et al.	
6,394,910	B1	5/2002	McCarthy	D643,892	S	8/2011	McGrorty	
D472,949	S	4/2003	Serrano	D645,104	S	9/2011	Nicolette et al.	
D474,821	S	5/2003	Wells et al.	8,096,039	B2	1/2012	Soracco et al.	
D474,949	S	5/2003	Schaffeld et al.	D653,718	S	2/2012	Stokke et al.	
D482,087	S	11/2003	Burrows	8,109,841	B2	2/2012	Miyamichi	
6,652,390	B2	11/2003	Bradford	D655,361	S	3/2012	Ramsauer	
D483,086	S	12/2003	Schweigert et al.	D661,753	S	6/2012	Cameron et al.	
D486,539	S	2/2004	Burrows	D666,260	S	8/2012	Cynn	
D486,872	S	2/2004	Schweigert et al.	D672,418	S	12/2012	Rollinson	
D488,200	S	4/2004	Olsavsky et al.	8,371,958	B2	2/2013	Treadwell	
D490,487	S	5/2004	Burrows	8,376,878	B2	2/2013	Bennett et al.	
				D688,339	S	8/2013	Hilton et al.	
				D688,341	S	8/2013	Rollinson	
				D691,226	S	10/2013	Hilton et al.	
				8,608,590	B2	12/2013	Hackel et al.	

(56)

References Cited

U.S. PATENT DOCUMENTS

D699,308 S 2/2014 Rollinson
 8,696,492 B1 4/2014 Hocknell et al.
 D704,782 S 5/2014 Rollinson
 8,721,472 B2 5/2014 Kuan et al.
 8,790,193 B2 7/2014 Serrano et al.
 D711,483 S 8/2014 Wong
 D715,388 S 10/2014 Serrano et al.
 D722,350 S 2/2015 Schweigert
 D722,351 S 2/2015 Parsons et al.
 D722,352 S 2/2015 Nicolette et al.
 D723,120 S 2/2015 Nicolette
 D724,164 S 3/2015 Schweigert et al.
 D725,208 S 3/2015 Schweigert
 D726,265 S 4/2015 Nicolette
 D726,846 S 4/2015 Schweigert
 D730,462 S 5/2015 Becktor et al.
 D732,122 S 6/2015 Becktor
 D732,618 S 6/2015 Becktor et al.
 D733,234 S 6/2015 Nicolette
 D735,283 S 7/2015 Solheim et al.
 9,108,088 B2 8/2015 Serrano et al.
 D738,447 S 9/2015 Schweigert
 D738,449 S 9/2015 Schweigert
 D739,487 S 9/2015 Schweigert
 D741,426 S 10/2015 Schweigert
 D746,926 S 1/2016 Parsons et al.
 D748,213 S 1/2016 Parsons et al.
 D748,215 S 1/2016 Parsons et al.
 9,233,283 B2 1/2016 Schweigert
 9,265,996 B1 2/2016 Abbott et al.
 D752,697 S 3/2016 Claveran
 D753,252 S 4/2016 Schweigert
 9,440,124 B2 9/2016 Parsons et al.
 9,498,685 B2 11/2016 Abbott et al.
 9,566,484 B1 2/2017 Abbott et al.
 D791,891 S 7/2017 Davis
 D794,146 S 8/2017 Davis
 D798,975 S 10/2017 Becktor
 D798,976 S 10/2017 Becktor
 D798,977 S 10/2017 Becktor
 D798,978 S 10/2017 Becktor
 D798,979 S 10/2017 Becktor
 D798,980 S 10/2017 Becktor
 D798,981 S 10/2017 Becktor et al.
 D799,619 S 10/2017 Becktor et al.
 D802,073 S 11/2017 Toulon
 D812,163 S 3/2018 Kroloff
 9,987,530 B2 6/2018 Jertson et al.
 D832,950 S * 11/2018 Serrano D21/746
 10,173,105 B2 1/2019 Myers et al.
 D839,977 S 2/2019 Rollinson et al.
 10,493,331 B2 * 12/2019 Kroloff A63B 53/0433
 D879,222 S * 3/2020 Serrano D21/742
 D893,655 S * 8/2020 Schweigert D21/759
 10,737,153 B2 * 8/2020 Schweigert A63B 53/0487

D896,903 S * 9/2020 Schweigert D21/743
 D909,504 S * 2/2021 Schweigert D21/736
 D909,505 S * 2/2021 Schweigert D21/736
 D909,506 S * 2/2021 Schweigert D21/736
 D910,789 S * 2/2021 Schweigert D21/736
 D910,790 S * 2/2021 Schweigert D21/736
 D913,388 S * 3/2021 Nicolette D21/736
 D913,389 S * 3/2021 Schweigert D21/736
 10,960,271 B2 * 3/2021 Kroloff A63B 53/0487
 D928,259 S * 8/2021 Andrews D21/736
 2004/0138003 A1 7/2004 Grace
 2004/0180730 A1 9/2004 Franklin et al.
 2006/0052178 A1 3/2006 Franklin et al.
 2006/0094522 A1 5/2006 Tang et al.
 2006/0223649 A1 10/2006 Rife
 2007/0129163 A1 6/2007 Solari
 2007/0135229 A1 6/2007 Lo et al.
 2007/0142122 A1 6/2007 Bonneau
 2007/0207875 A1 9/2007 Kuan et al.
 2007/0238548 A1 10/2007 Johnson
 2008/0139333 A1 6/2008 Klein
 2008/0146372 A1 6/2008 John
 2008/0176672 A1 7/2008 Roach et al.
 2009/0029800 A1 1/2009 Jones et al.
 2010/0255922 A1 10/2010 Lueders
 2011/0165959 A1 7/2011 Klein
 2013/0165256 A1 6/2013 Stevenson
 2013/0210537 A1 8/2013 Ainscough et al.
 2015/0057100 A1 2/2015 Serrano et al.
 2015/0258390 A1 9/2015 DeFrancesco, Jr.
 2015/0306477 A1 10/2015 Parsons et al.
 2016/0016050 A1 1/2016 Rife
 2016/0346649 A1 12/2016 Jertson et al.
 2017/0036078 A1 * 2/2017 Serrano A63B 60/52
 2018/0001163 A1 1/2018 Becktor et al.
 2018/0311545 A1 * 11/2018 Lambeth B23P 15/00

FOREIGN PATENT DOCUMENTS

KR 200377377 Y1 3/2005
 KR 200403045 Y1 12/2005
 KR 20100065481 A 6/2010
 KR 101773069 B1 8/2017

OTHER PUBLICATIONS

Pxg putters google search; google.com; Jan. 6, 2023.*
 Pxg.com; Jan. 6, 2023.*
 Plugged in Golf (2015 Bettinardi Putters Review) [online] Mar. 3, 2015 [retrieve Nov. 25, 2019].
 TourSpecGolf(Golds Factory Multi Weighted Custom Putter) [online]. Nov. 20, 2010 [retrieved Apr. 26, 2016] Retrieved from the internet: URL: <http://www.tourspecgolf.com/blog/golds-factory-multi-weighted-custom-putter/>.
 U.S. Appl. No. 29/523,587, Schweigert, "Golf Club Head," filed Apr. 10, 2015.

* cited by examiner

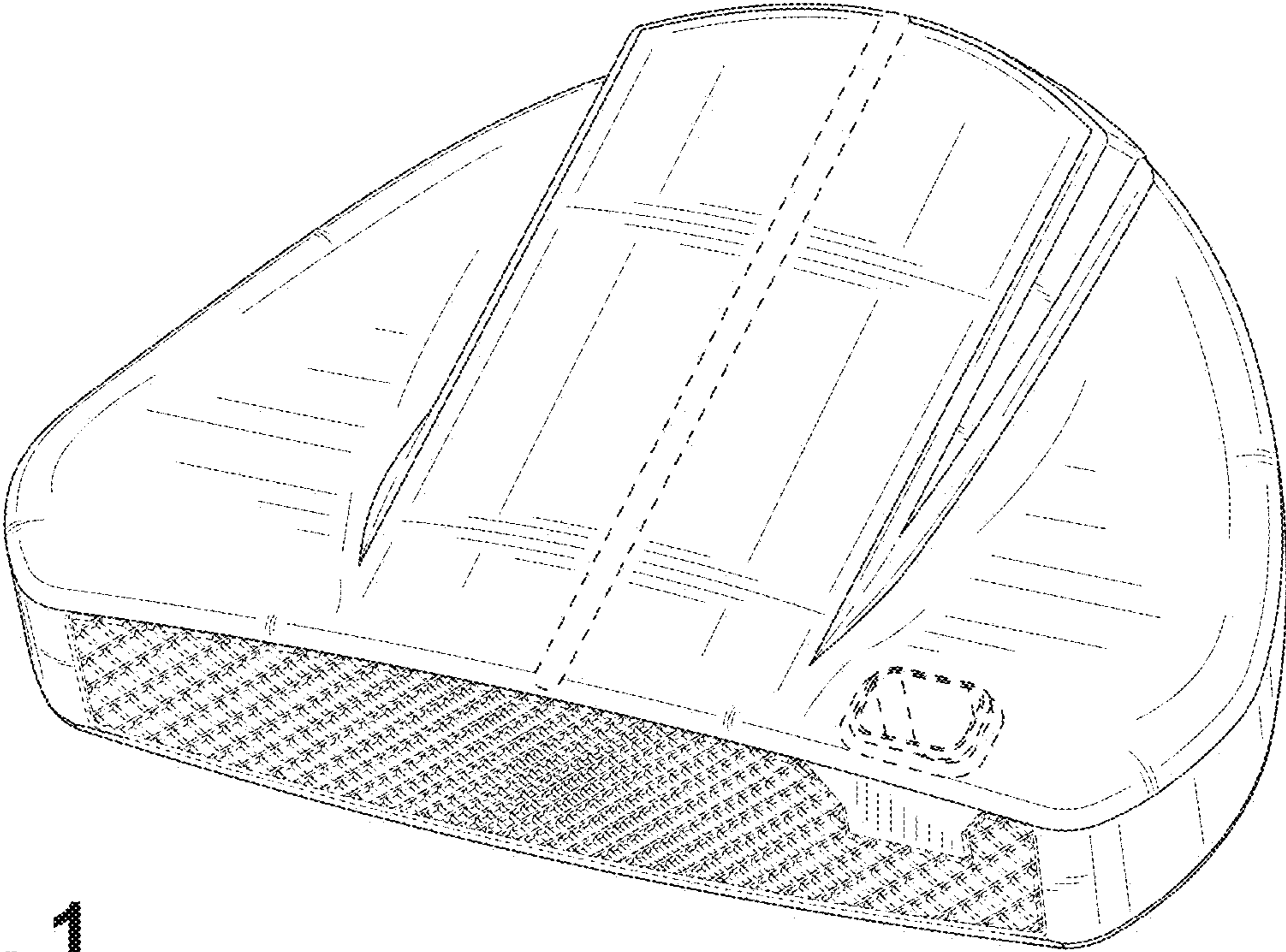

FIG. 1

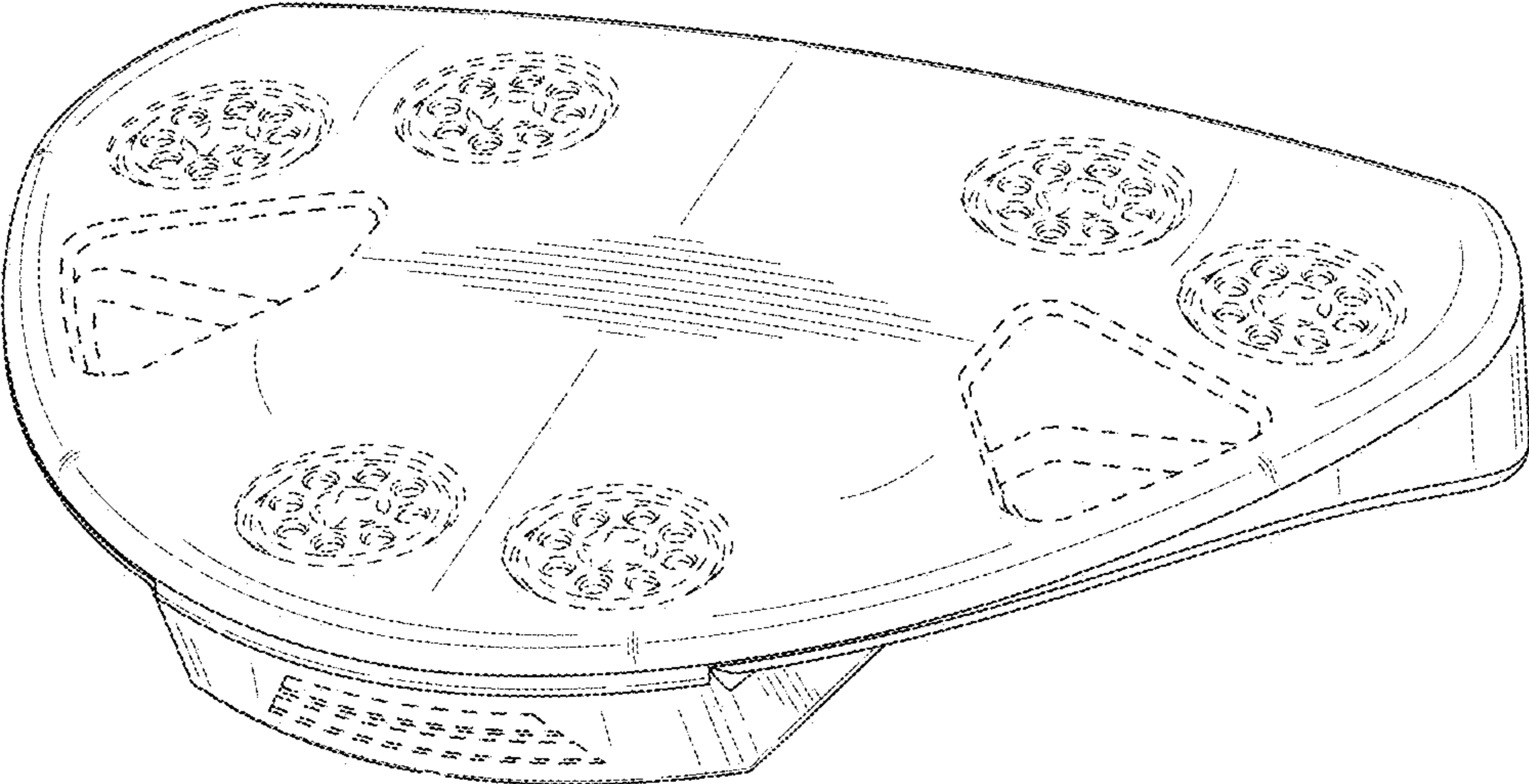

FIG. 2

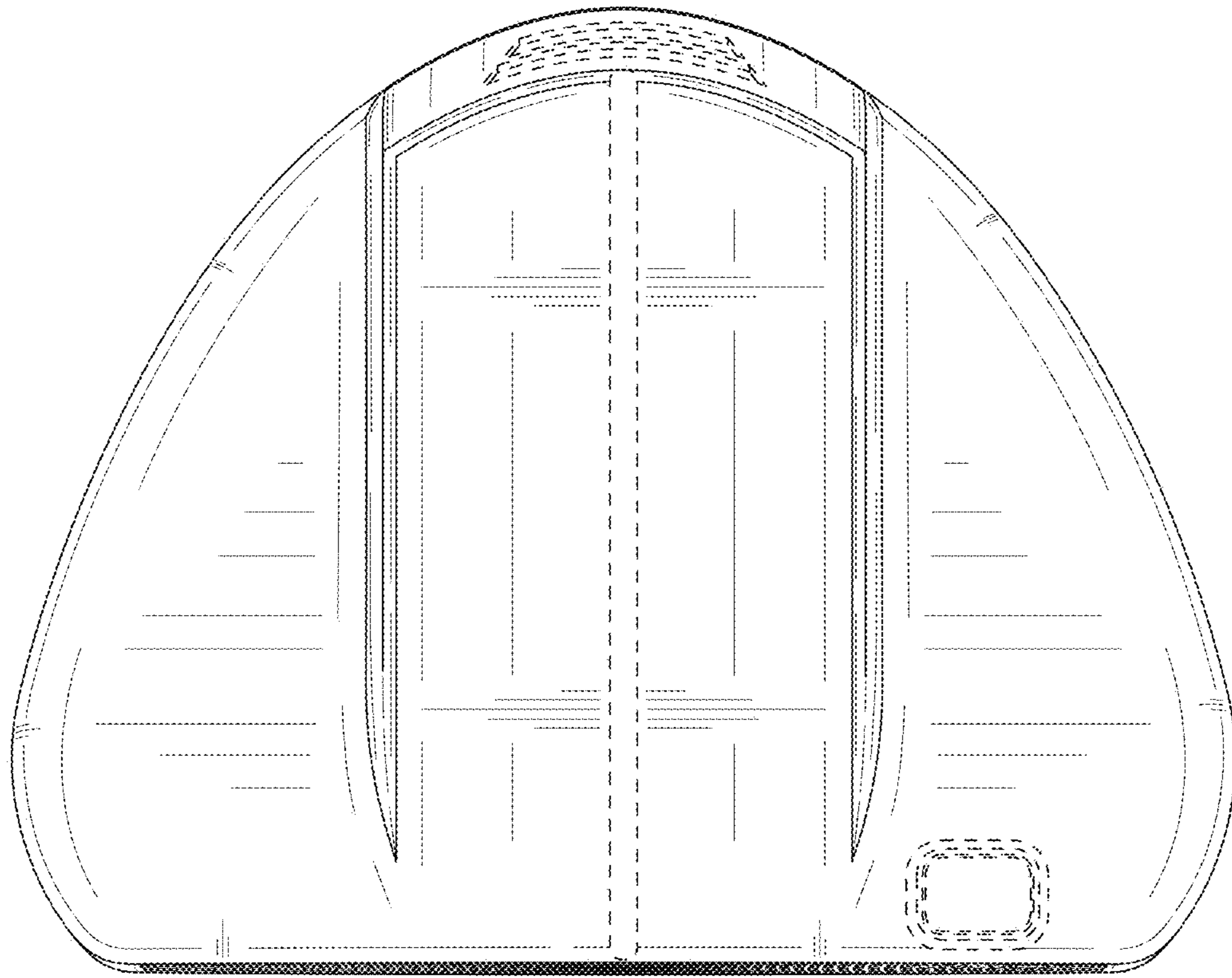

FIG. 3

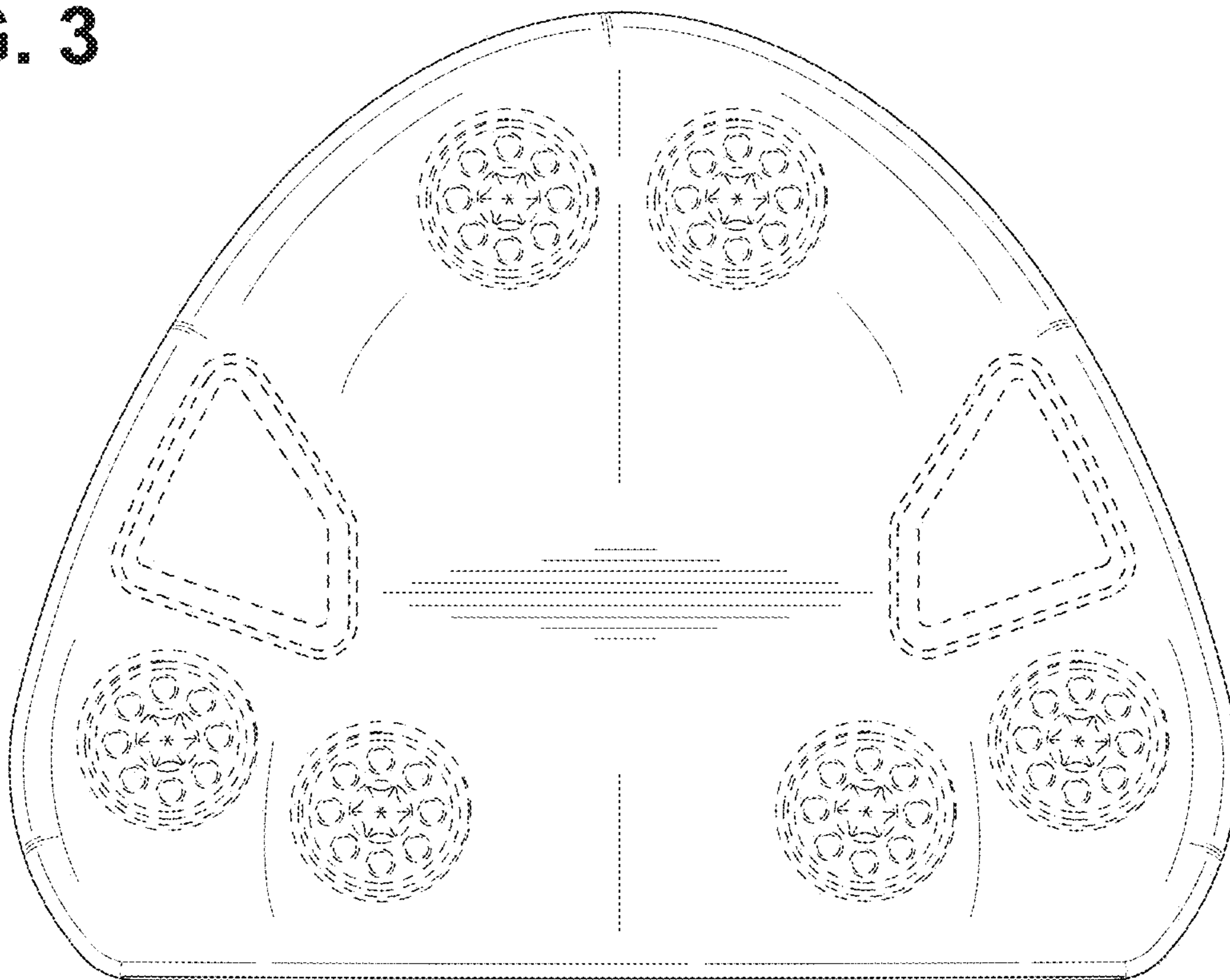

FIG. 4

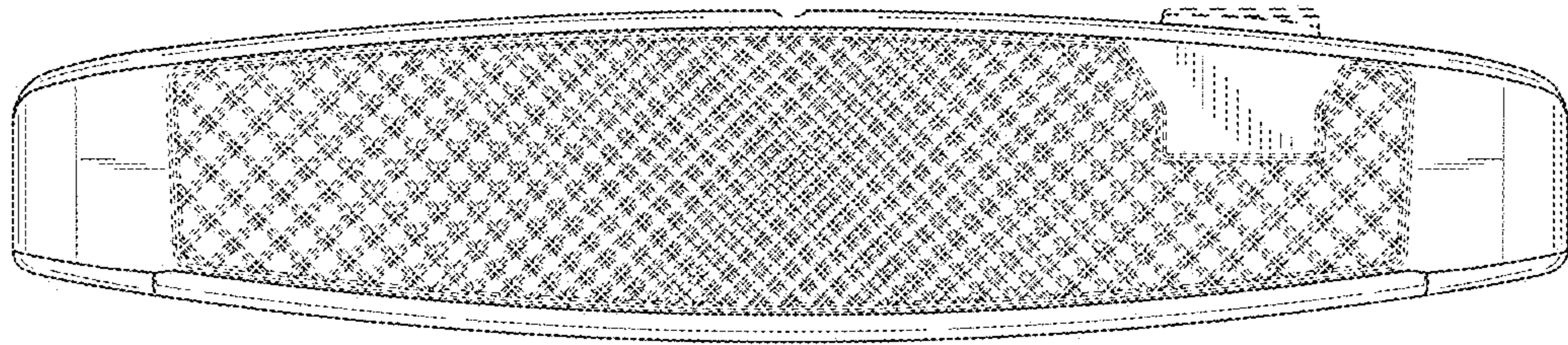

FIG. 5

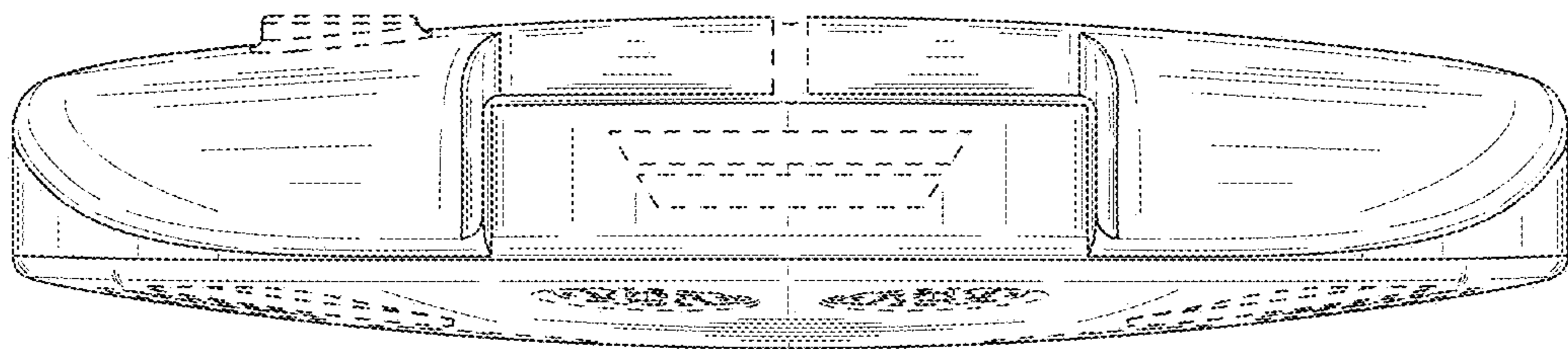

FIG. 6

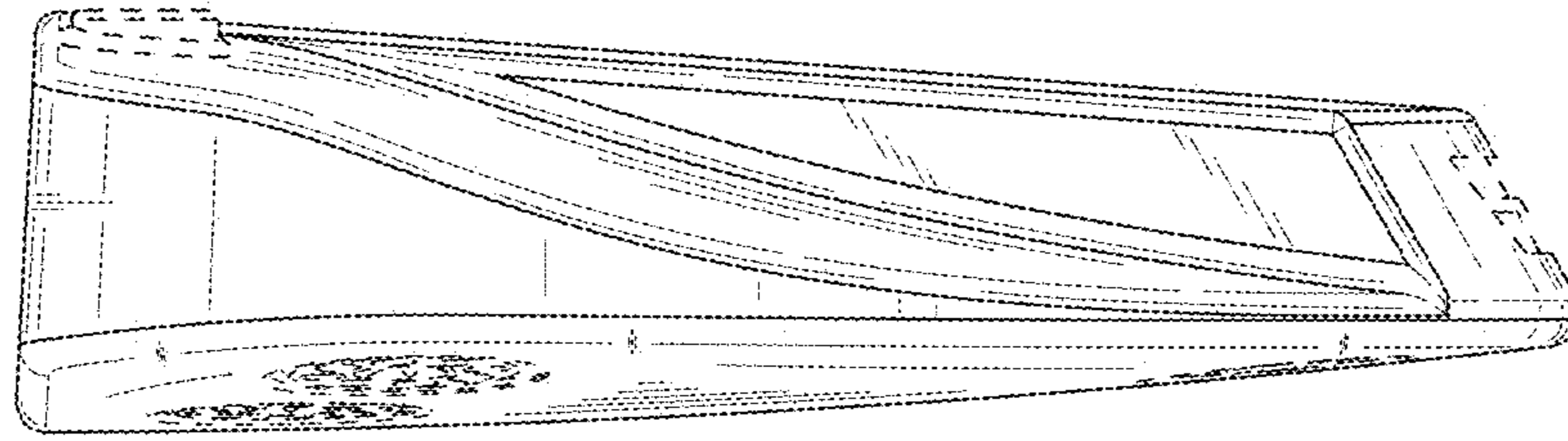

FIG. 7

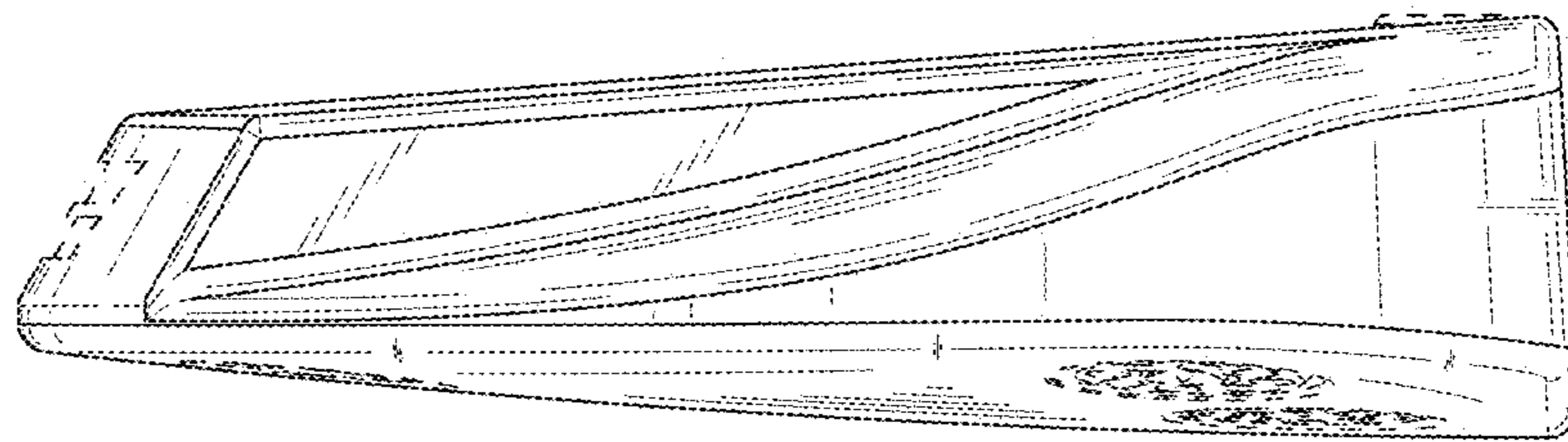

FIG. 8