



US00D986998S

(12) **United States Design Patent**  
**Andrews**

(10) **Patent No.:** **US D986,998 S**  
(45) **Date of Patent:** **\*\* May 23, 2023**

(54) **GOLF CLUB HEAD**

(71) Applicant: **PARSONS XTREME GOLF, LLC**,  
Scottsdale, AZ (US)

(72) Inventor: **Matthew T. Andrews**, Scottsdale, AZ  
(US)

(73) Assignee: **PARSONS XTREME GOLF, LLC**,  
Scottsdale, AZ (US)

(\*\*) Term: **15 Years**

(21) Appl. No.: **29/799,565**

(22) Filed: **Jul. 15, 2021**

**Related U.S. Application Data**

(60) Division of application No. 29/713,443, filed on Nov. 15, 2019, now Pat. No. Des. 928,259, which is a continuation-in-part of application No. 29/710,168, filed on Oct. 21, 2019, now abandoned.

(51) **LOC (14) Cl.** ..... **21-02**

(52) **U.S. Cl.**  
USPC ..... **D21/736**

(58) **Field of Classification Search**  
USPC ..... D21/736-746, 759  
CPC ..... A63B 53/00; A63B 53/04; A63B 53/007;  
A63B 53/065; A63B 53/0487; A63B  
60/00; A63B 60/46  
See application file for complete search history.

(56) **References Cited**

**U.S. PATENT DOCUMENTS**

723,534 A 3/1903 Knight  
922,444 A 5/1909 Youds  
1,094,599 A 4/1914 Samson  
D57,980 S 5/1921 Kraeuter  
D63,284 S 11/1923 Challis  
RE19,178 E 5/1934 Spiker

4,043,562 A 8/1977 Shillington  
D248,783 S 8/1978 Long  
4,340,230 A 7/1982 Churchward  
D281,092 S 10/1985 Mills  
4,754,977 A 7/1988 Sahm  
4,869,507 A 9/1989 Sahm

(Continued)

**FOREIGN PATENT DOCUMENTS**

JP 2004223184 A 8/2004  
JP 2005160691 A 6/2005

(Continued)

**OTHER PUBLICATIONS**

Golf putters google search; google.com; Jan. 6, 2023.\*

(Continued)

*Primary Examiner* — Mitchell I. Siegel

(57) **CLAIM**

The ornamental design for a golf club head, as shown and described.

**DESCRIPTION**

FIG. 1 is a top perspective view of a golf club head;  
FIG. 2 is a bottom perspective view of the golf club head of FIG. 1;  
FIG. 3 is a front elevational view of the golf club head of FIG. 1;  
FIG. 4 is a rear elevational view of the golf club head of FIG. 1;  
FIG. 5 is a top view of the golf club head of FIG. 1;  
FIG. 6 is a bottom view of the golf club head of FIG. 1;  
FIG. 7 is a left side view of the golf club head of FIG. 1; and,  
FIG. 8 is a right side view of the golf club head of FIG. 1.  
The broken lines shown on the drawings form no part of the claimed design.

**1 Claim, 4 Drawing Sheets**

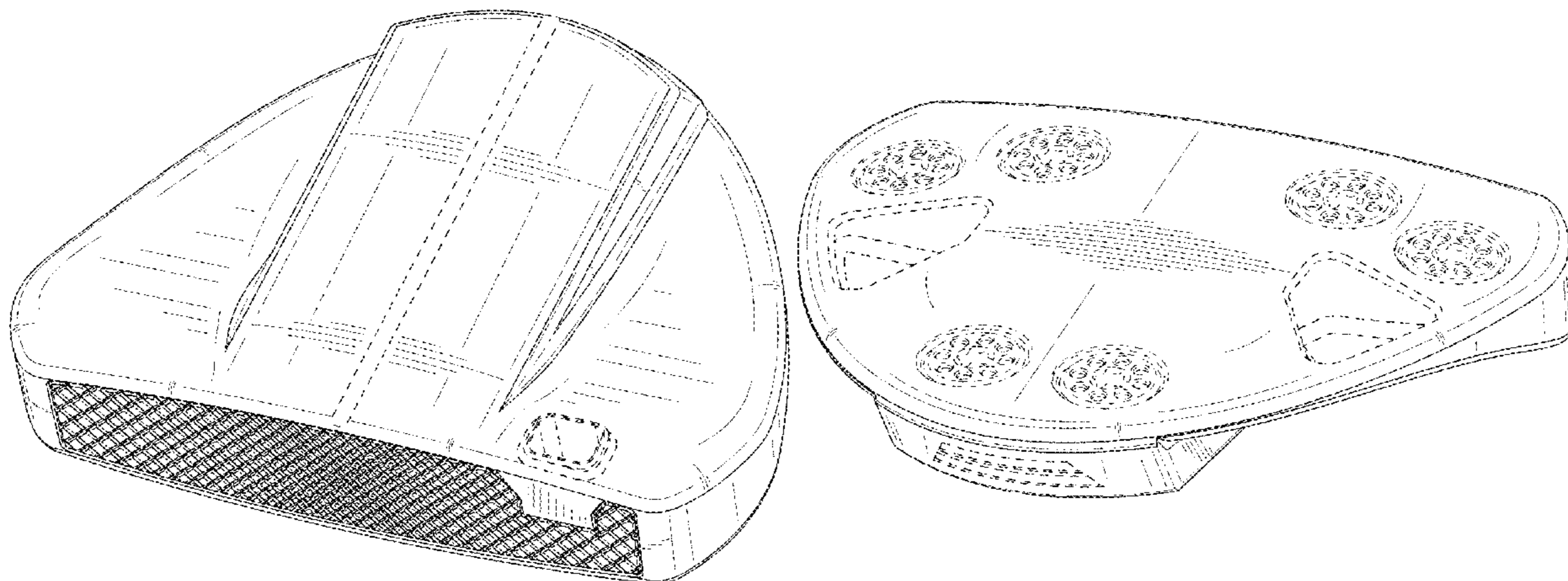



(56)

References Cited

U.S. PATENT DOCUMENTS

D699,308 S 2/2014 Rollinson  
 8,696,492 B1 4/2014 Hocknell et al.  
 D704,782 S 5/2014 Rollinson  
 8,721,472 B2 5/2014 Kuan et al.  
 8,790,193 B2 7/2014 Serrano et al.  
 D711,483 S 8/2014 Wong  
 D715,388 S 10/2014 Serrano et al.  
 D722,350 S 2/2015 Schweigert  
 D722,351 S 2/2015 Parsons et al.  
 D722,352 S 2/2015 Nicolette et al.  
 D723,120 S 2/2015 Nicolette  
 D724,164 S 3/2015 Schweigert et al.  
 D725,208 S 3/2015 Schweigert  
 D726,265 S 4/2015 Nicolette  
 D726,846 S 4/2015 Schweigert  
 D730,462 S 5/2015 Becktor et al.  
 D732,122 S 6/2015 Becktor  
 D732,618 S 6/2015 Becktor et al.  
 D733,234 S 6/2015 Nicolette  
 D735,283 S 7/2015 Solheim et al.  
 9,108,088 B2 8/2015 Serrano et al.  
 D738,447 S 9/2015 Schweigert  
 D738,449 S 9/2015 Schweigert  
 D739,487 S 9/2015 Schweigert  
 D741,426 S 10/2015 Schweigert  
 D746,926 S 1/2016 Parsons et al.  
 D748,213 S 1/2016 Parsons et al.  
 D748,215 S 1/2016 Parsons et al.  
 9,233,283 B2 1/2016 Schweigert  
 9,265,996 B1 2/2016 Abbott et al.  
 D752,697 S 3/2016 Claveran  
 D753,252 S 4/2016 Schweigert  
 9,440,124 B2 9/2016 Parsons et al.  
 9,498,685 B2 11/2016 Abbott et al.  
 9,566,484 B1 2/2017 Abbott et al.  
 D791,891 S 7/2017 Davis  
 D794,146 S 8/2017 Davis  
 D798,975 S 10/2017 Becktor  
 D798,976 S 10/2017 Becktor  
 D798,977 S 10/2017 Becktor  
 D798,978 S 10/2017 Becktor  
 D798,979 S 10/2017 Becktor  
 D798,980 S 10/2017 Becktor  
 D798,981 S 10/2017 Becktor et al.  
 D799,619 S 10/2017 Becktor et al.  
 D802,073 S 11/2017 Toulon  
 D812,163 S 3/2018 Kroloff  
 9,987,530 B2 6/2018 Jertson et al.  
 D832,950 S \* 11/2018 Serrano ..... D21/746  
 10,173,105 B2 1/2019 Myers et al.  
 D839,977 S 2/2019 Rollinson et al.  
 10,493,331 B2 \* 12/2019 Kroloff ..... A63B 53/0433  
 D879,222 S \* 3/2020 Serrano ..... D21/742  
 D893,655 S \* 8/2020 Schweigert ..... D21/759  
 10,737,153 B2 \* 8/2020 Schweigert ..... A63B 53/0487

D896,903 S \* 9/2020 Schweigert ..... D21/743  
 D909,504 S \* 2/2021 Schweigert ..... D21/736  
 D909,505 S \* 2/2021 Schweigert ..... D21/736  
 D909,506 S \* 2/2021 Schweigert ..... D21/736  
 D910,789 S \* 2/2021 Schweigert ..... D21/736  
 D910,790 S \* 2/2021 Schweigert ..... D21/736  
 D913,388 S \* 3/2021 Nicolette ..... D21/736  
 D913,389 S \* 3/2021 Schweigert ..... D21/736  
 10,960,271 B2 \* 3/2021 Kroloff ..... A63B 53/0487  
 D928,259 S \* 8/2021 Andrews ..... D21/736  
 2004/0138003 A1 7/2004 Grace  
 2004/0180730 A1 9/2004 Franklin et al.  
 2006/0052178 A1 3/2006 Franklin et al.  
 2006/0094522 A1 5/2006 Tang et al.  
 2006/0223649 A1 10/2006 Rife  
 2007/0129163 A1 6/2007 Solari  
 2007/0135229 A1 6/2007 Lo et al.  
 2007/0142122 A1 6/2007 Bonneau  
 2007/0207875 A1 9/2007 Kuan et al.  
 2007/0238548 A1 10/2007 Johnson  
 2008/0139333 A1 6/2008 Klein  
 2008/0146372 A1 6/2008 John  
 2008/0176672 A1 7/2008 Roach et al.  
 2009/0029800 A1 1/2009 Jones et al.  
 2010/0255922 A1 10/2010 Lueders  
 2011/0165959 A1 7/2011 Klein  
 2013/0165256 A1 6/2013 Stevenson  
 2013/0210537 A1 8/2013 Ainscough et al.  
 2015/0057100 A1 2/2015 Serrano et al.  
 2015/0258390 A1 9/2015 DeFrancesco, Jr.  
 2015/0306477 A1 10/2015 Parsons et al.  
 2016/0016050 A1 1/2016 Rife  
 2016/0346649 A1 12/2016 Jertson et al.  
 2017/0036078 A1 \* 2/2017 Serrano ..... A63B 60/52  
 2018/0001163 A1 1/2018 Becktor et al.  
 2018/0311545 A1 \* 11/2018 Lambeth ..... B23P 15/00

FOREIGN PATENT DOCUMENTS

KR 200377377 Y1 3/2005  
 KR 200403045 Y1 12/2005  
 KR 20100065481 A 6/2010  
 KR 101773069 B1 8/2017

OTHER PUBLICATIONS

Pxg putters google search; google.com; Jan. 6, 2023.\*  
 pxg.com; Jan. 6, 2023.\*  
 Plugged in Golf (2015 Bettinardi Putters Review) [online]. Mar. 3, 2015 [retrieve Nov. 25, 2019].  
 TourSpecGolf(Golds Factory Multi Weighted Custom Putter) [online]. Nov. 20, 2010 [retrieved Apr. 26, 2016] Retrieved from the internet: URL: <http://www.tourspecgolf.com/blog/golds-factory-multi-weighted-custom-putter/>.  
 U.S. Appl. No. 29/523,587, Schweigert, "Golf Club Head," filed Apr. 10, 2015.

\* cited by examiner

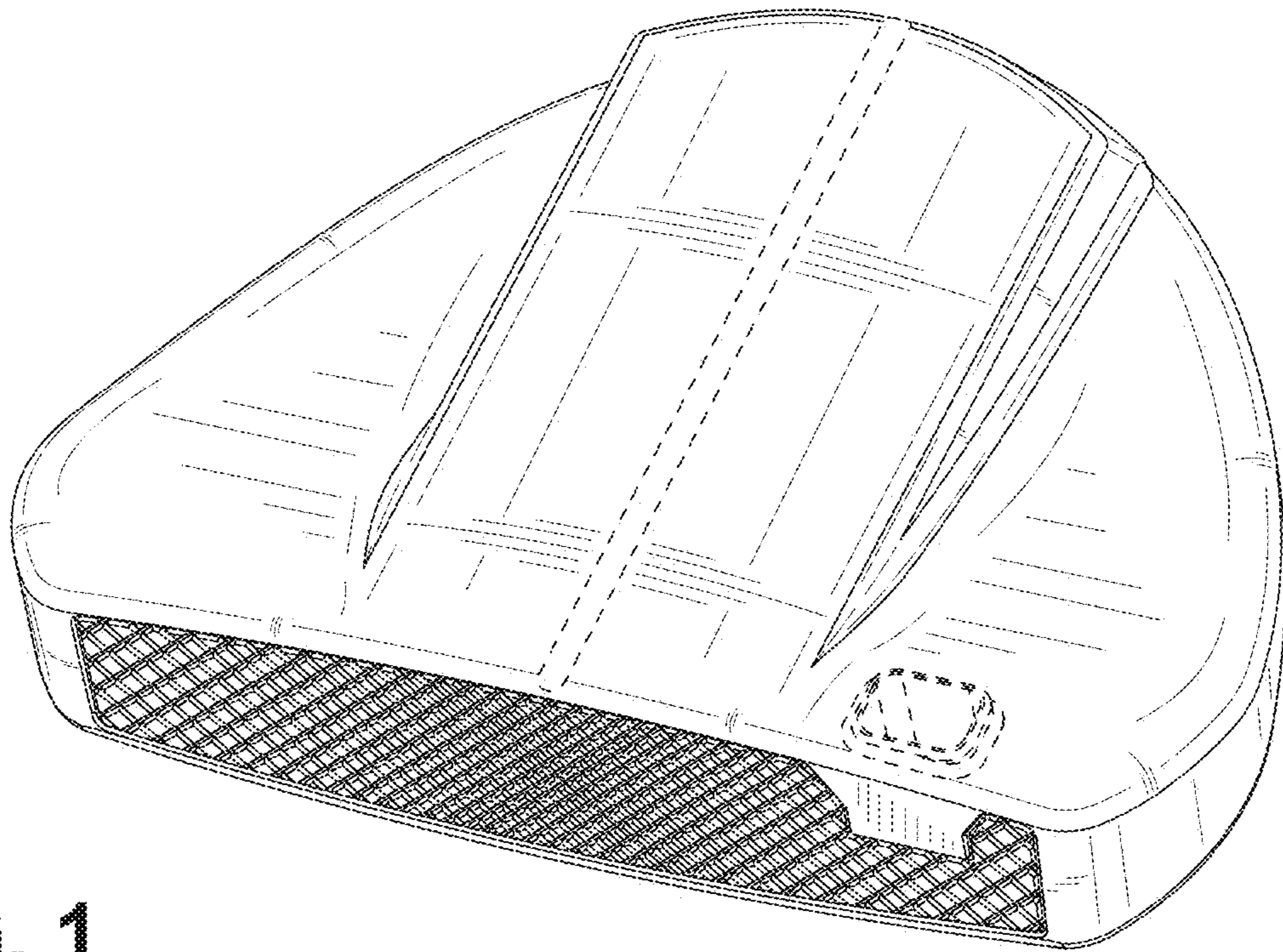

**FIG. 1**

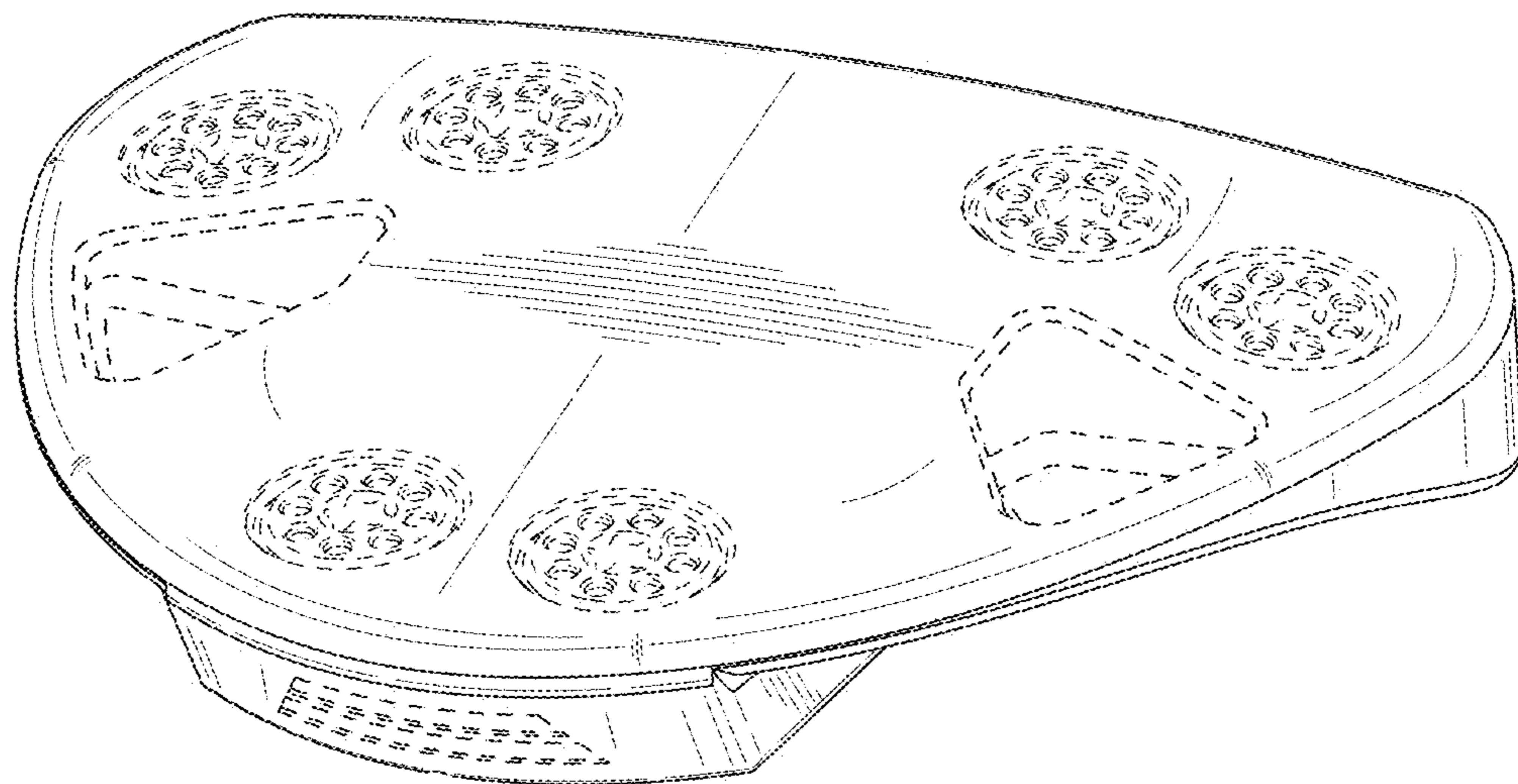

**FIG. 2**

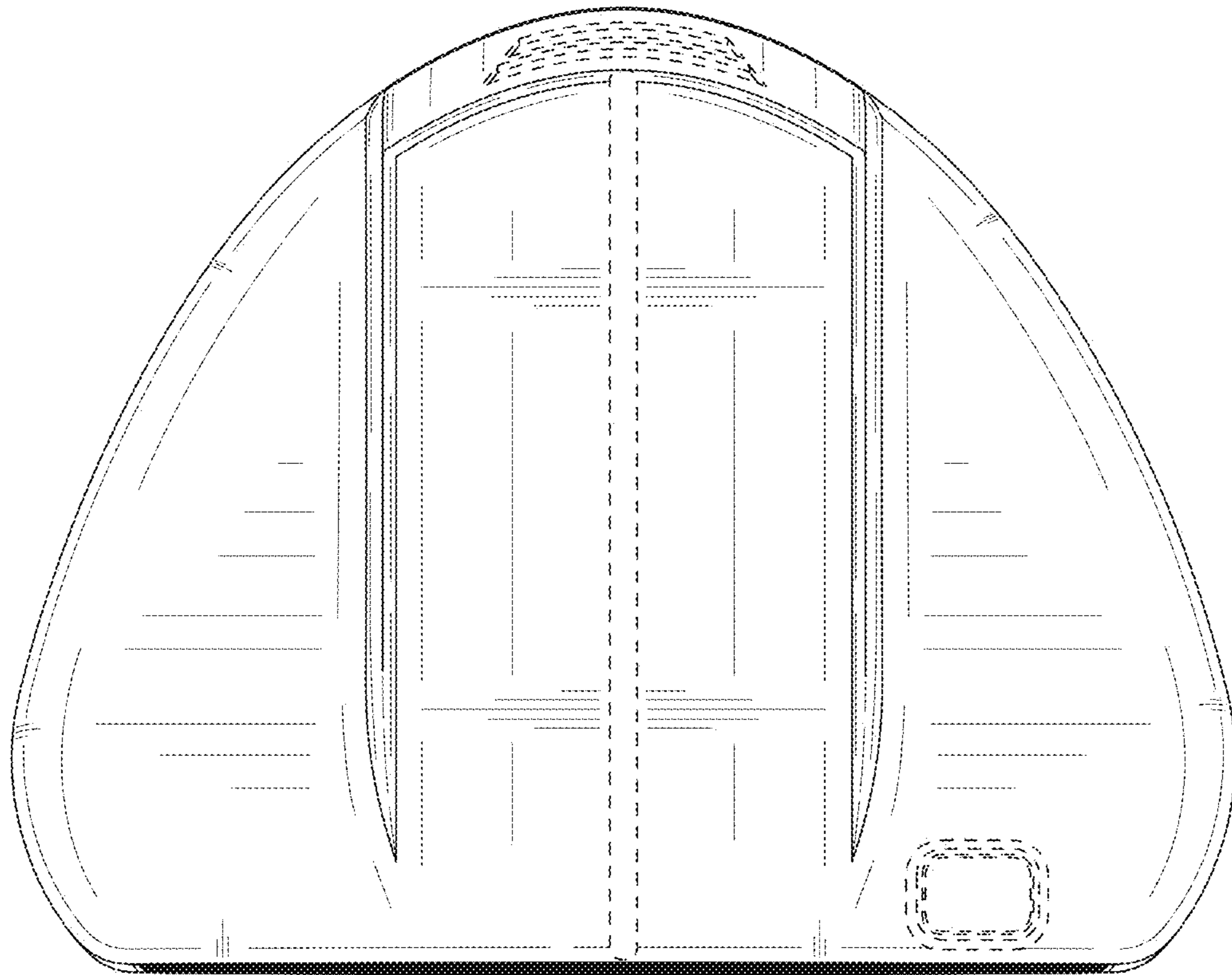

**FIG. 3**

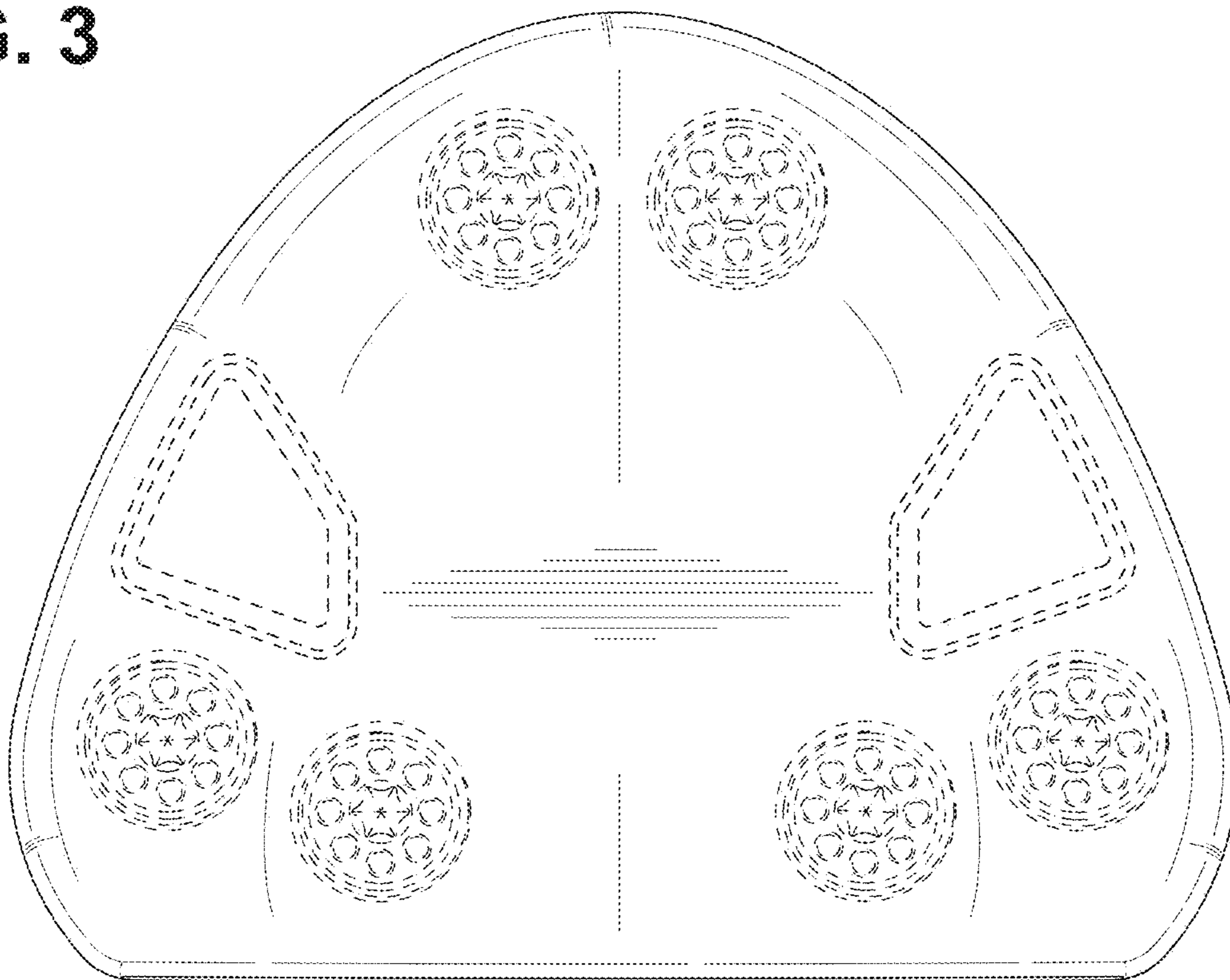

**FIG. 4**

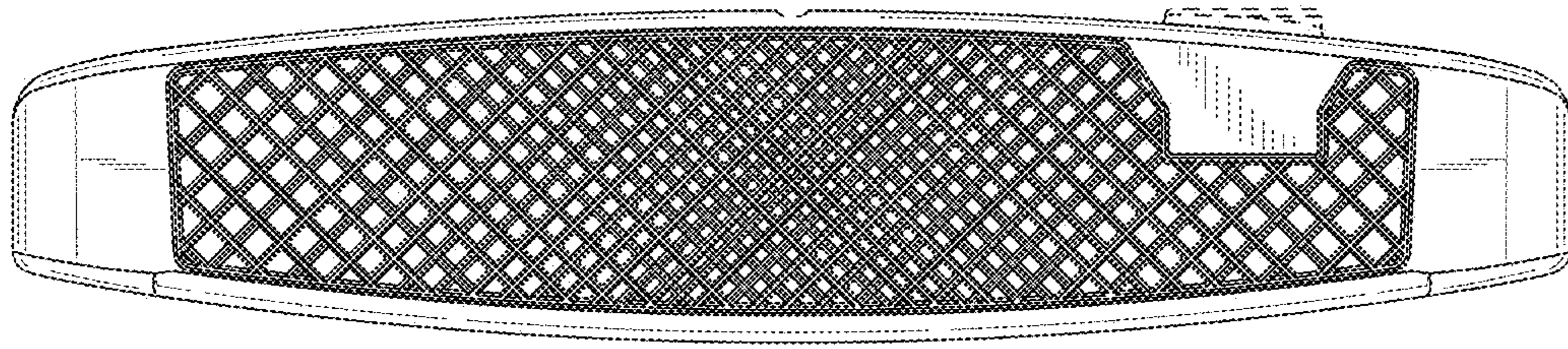

**FIG. 5**

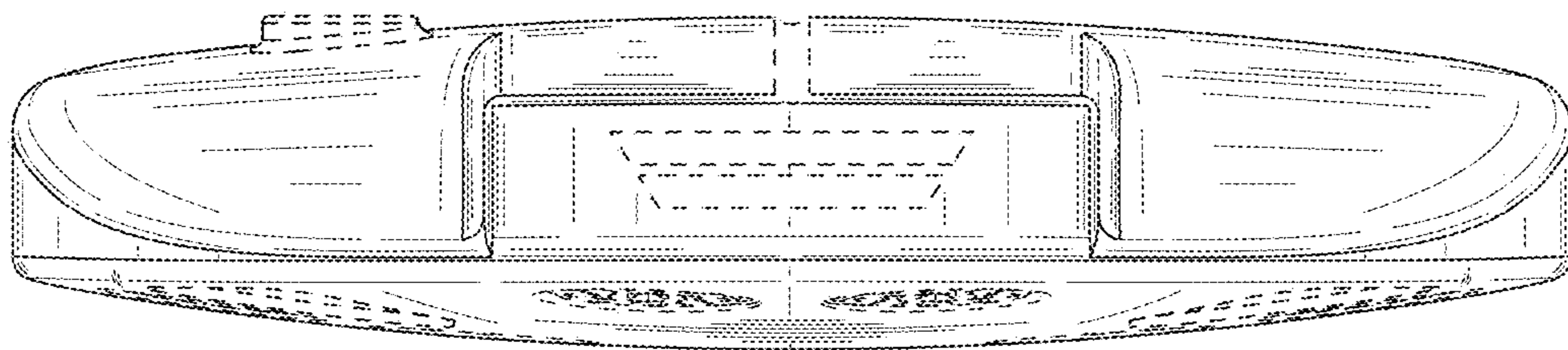

**FIG. 6**

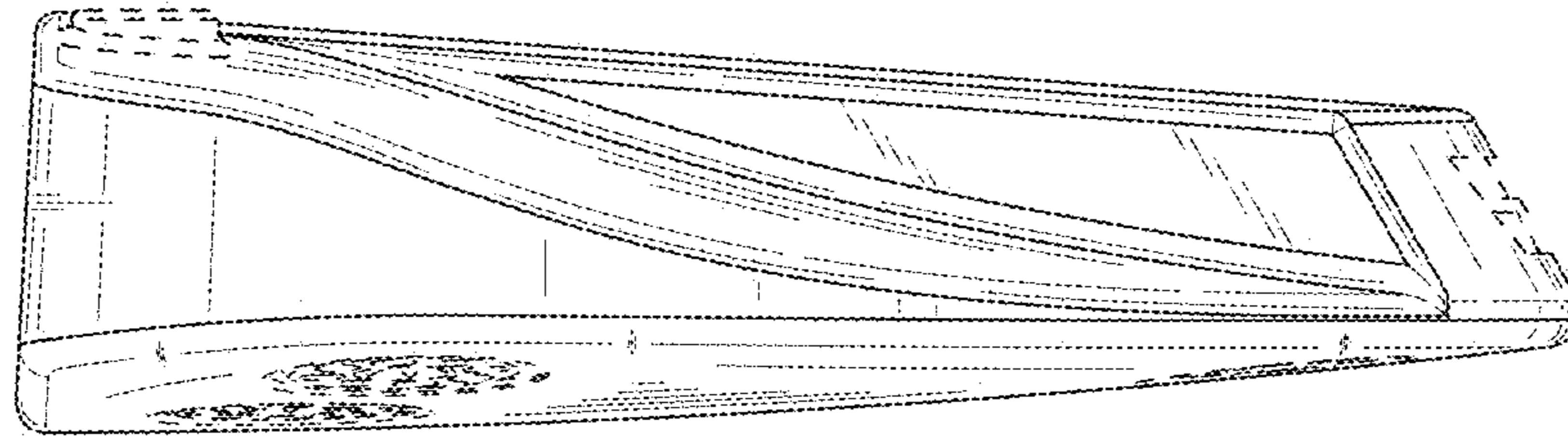

**FIG. 7**

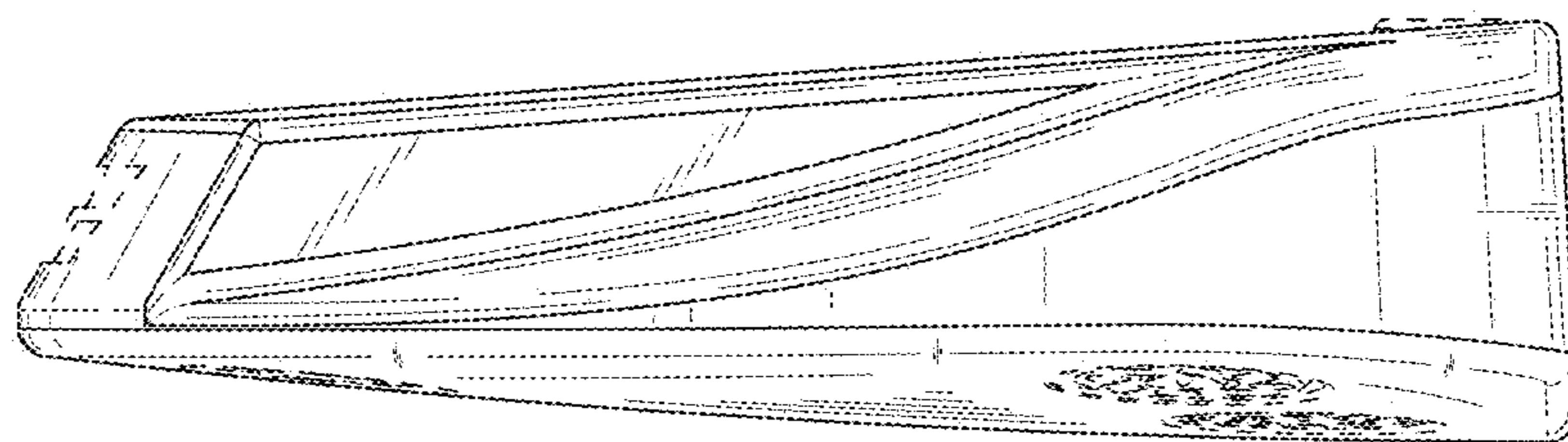

**FIG. 8**