



US00D986967S

(12) **United States Design Patent**
Zheng

(10) **Patent No.:** **US D986,967 S**

(45) **Date of Patent:** **** May 23, 2023**

(54) **PENCIL HOLDER**

(71) Applicant: **FUZHOU INFINITY HOME CO., LTD**, Fuzhou (CN)

(72) Inventor: **Huihai Zheng**, Fuzhou (CN)

(73) Assignee: **FUZHOU INFINITY HOME CO., LTD**, Fuzhou (CN)

(**) Term: **15 Years**

(21) Appl. No.: **29/781,024**

(22) Filed: **Apr. 28, 2021**

(30) **Foreign Application Priority Data**

Nov. 17, 2020 (CN) 202030695468.3

(51) **LOC (14) Cl.** **19-06**

(52) **U.S. Cl.**
USPC **D19/85**

(58) **Field of Classification Search**
USPC D19/86, 87, 89, 90, 91, 92, 95, 96, 97, D19/99
CPC . B42F 17/02; A45C 11/18; A45C 1/06; G09F 3/20
See application file for complete search history.

(56) **References Cited**

U.S. PATENT DOCUMENTS

986,395 A * 3/1911 King A01G 9/28 47/33
D279,950 S * 8/1985 Wan D6/680
D499,144 S * 11/2004 Chang D19/76
D555,034 S * 11/2007 Van de Wetering D11/134
D708,257 S * 7/2014 Camarata D19/77

D930,934 S * 9/2021 Hale D34/14
D948,615 S * 4/2022 Li D19/107
2017/0047754 A1* 2/2017 Fochs H02J 1/002

FOREIGN PATENT DOCUMENTS

CN 303702540 * 6/2016
EM 008771406-0001 * 12/2021

OTHER PUBLICATIONS

Unfinished Wooden Jewelry Box posted by Exceart posted date Apr. 15, 2020, © Amazon, [online], [site visited Feb. 23, 2023]. Available from Internet, <https://www.amazon.com/EXCEART-Keepsake-Organizer-7Compartments-Bracelet/dp/B0874CCPDR> (Year: 2020).
Wooden Desk Organizer posted by Grove posted date Apr. 16, 2021, © Amazon, [online], [site visited Feb. 23, 2023]. Available from Internet, <https://www.amazon.com/GROVE-grow-love-Wooden-Organizer> (Year: 2021).*

(Continued)

Primary Examiner — Garth Rademaker
Assistant Examiner — Laura H Yu

(57) **CLAIM**

The ornamental design for a pencil holder, as shown and described.

DESCRIPTION

FIG. 1 is a perspective view of a pencil holder showing my new design;
FIG. 2 is another perspective view thereof;
FIG. 3 is a front elevational view thereof;
FIG. 4 is a rear elevational view thereof;
FIG. 5 is a left side elevational view thereof;
FIG. 6 is a right side elevational view thereof;
FIG. 7 is a top plan view thereof; and,
FIG. 8 is a bottom plan view thereof.

1 Claim, 8 Drawing Sheets

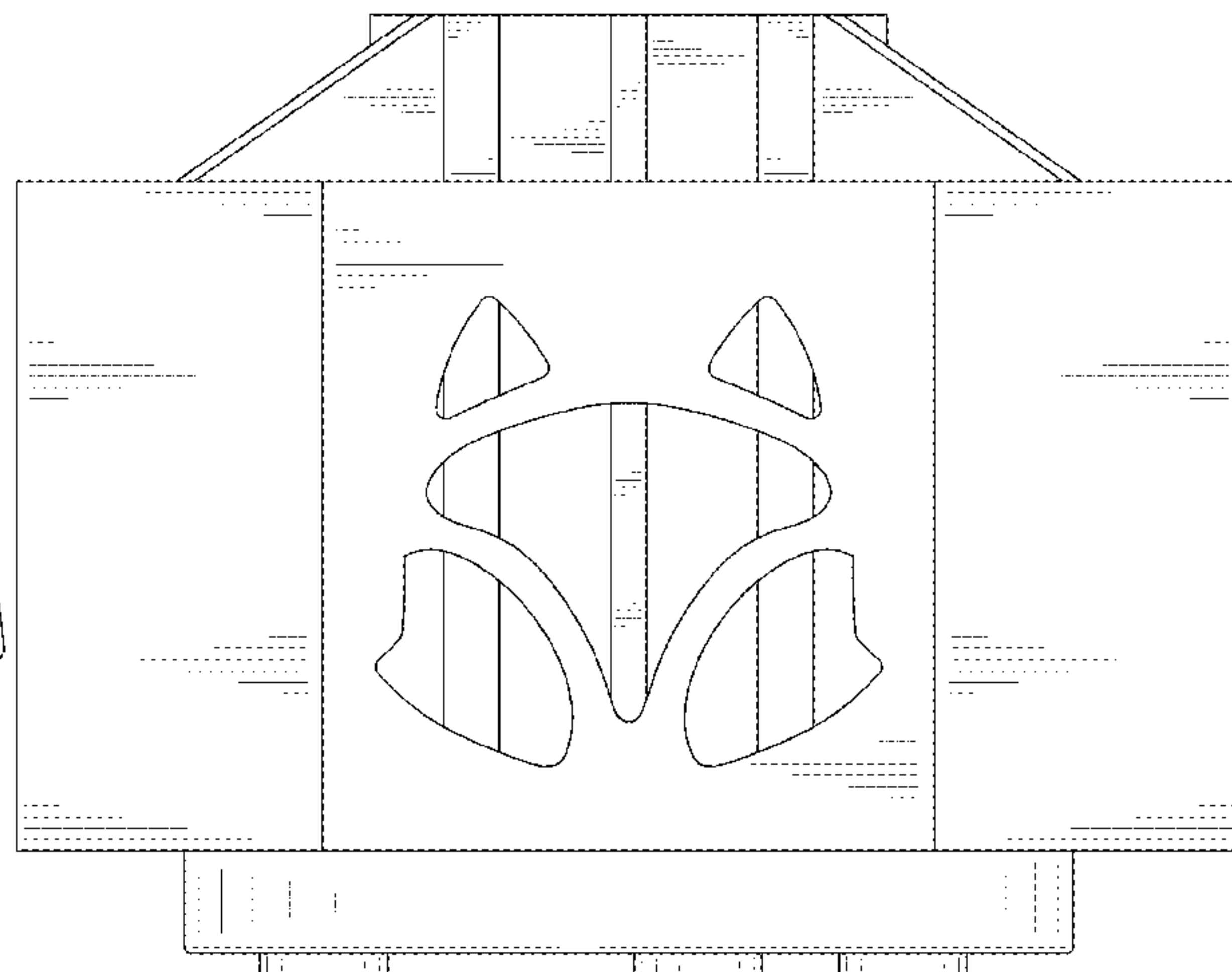
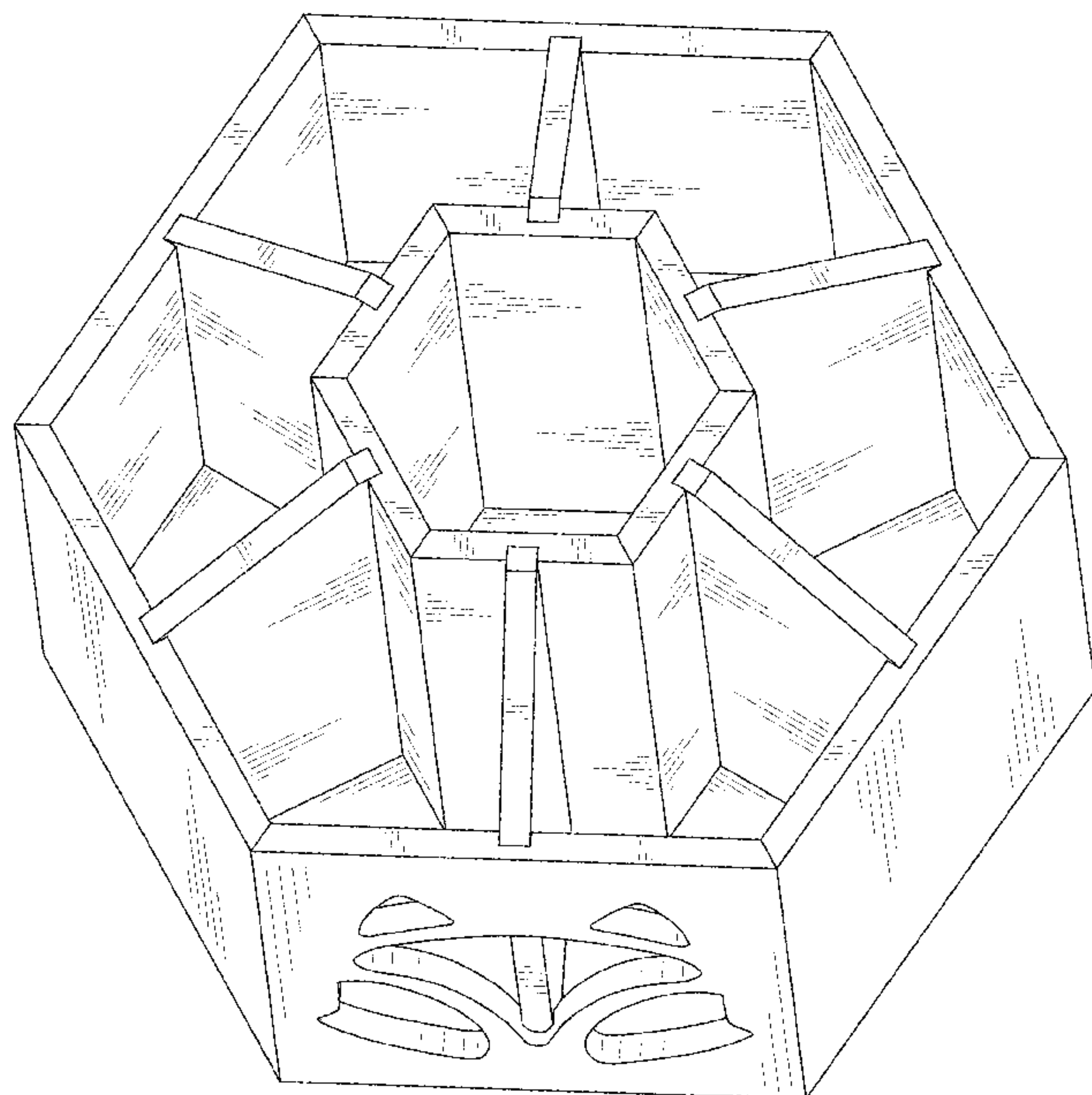

(56)

References Cited

OTHER PUBLICATIONS

Clear Rotating Desktop Organizer posted by Design Styles posted date Feb. 26, 2019, © Amazon, [online], [site visited Feb. 23, 2023]. Available from Internet, <https://www.amazon.com/Clear-Rotating-Desktop-Organizer-Designstyles/> (Year: 2019).*

Clear Rotating Desktop Organizer posted by Zonon posted date Jan. 11, 2021, © Amazon, [online], [site visited Feb. 23, 2023]. Available from Internet, <https://www.amazon.com/Rotating-Rotatable-Organizer-Compartments-Supplies> (Year: 2021).*

* cited by examiner

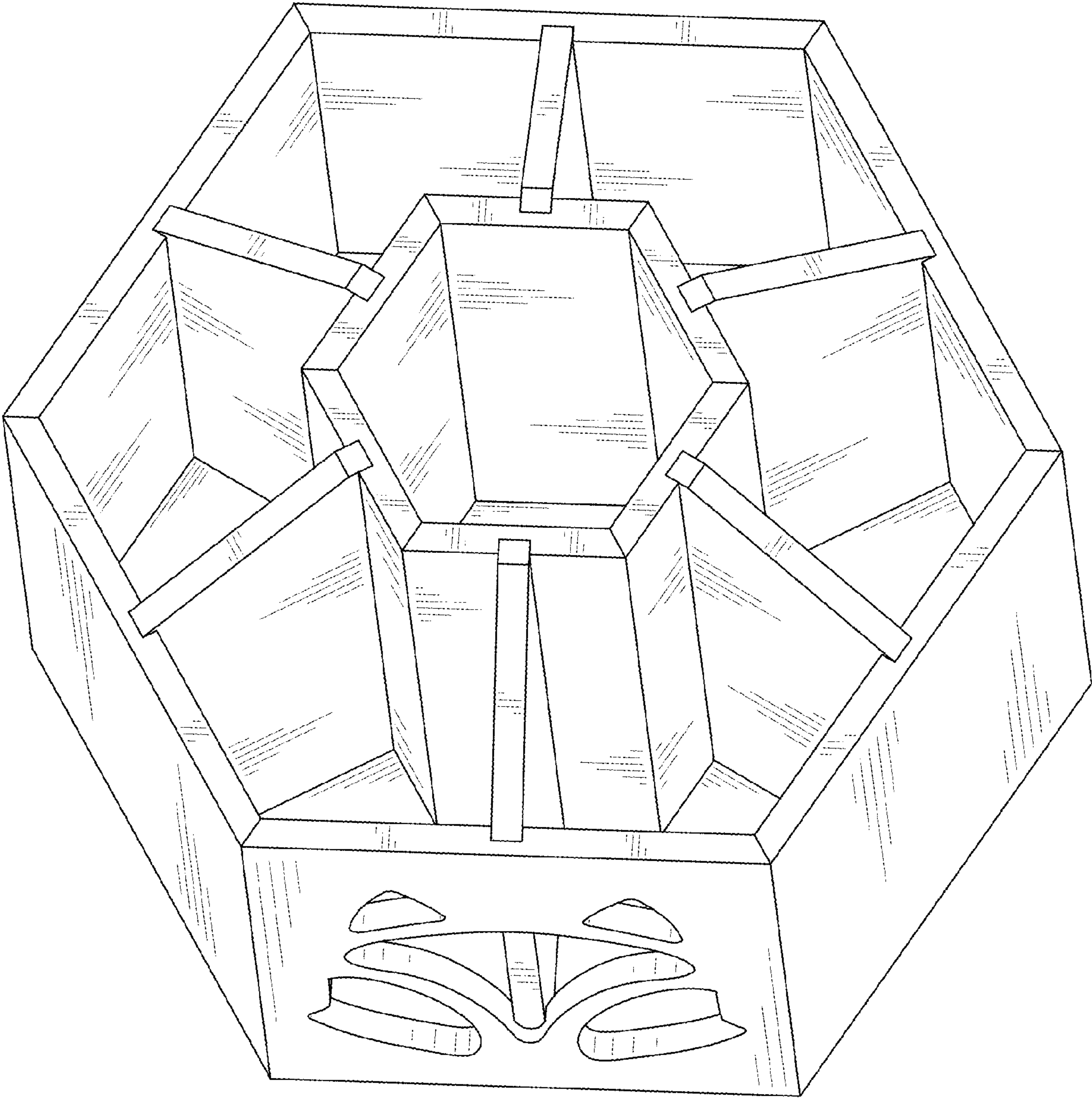

FIG. 1

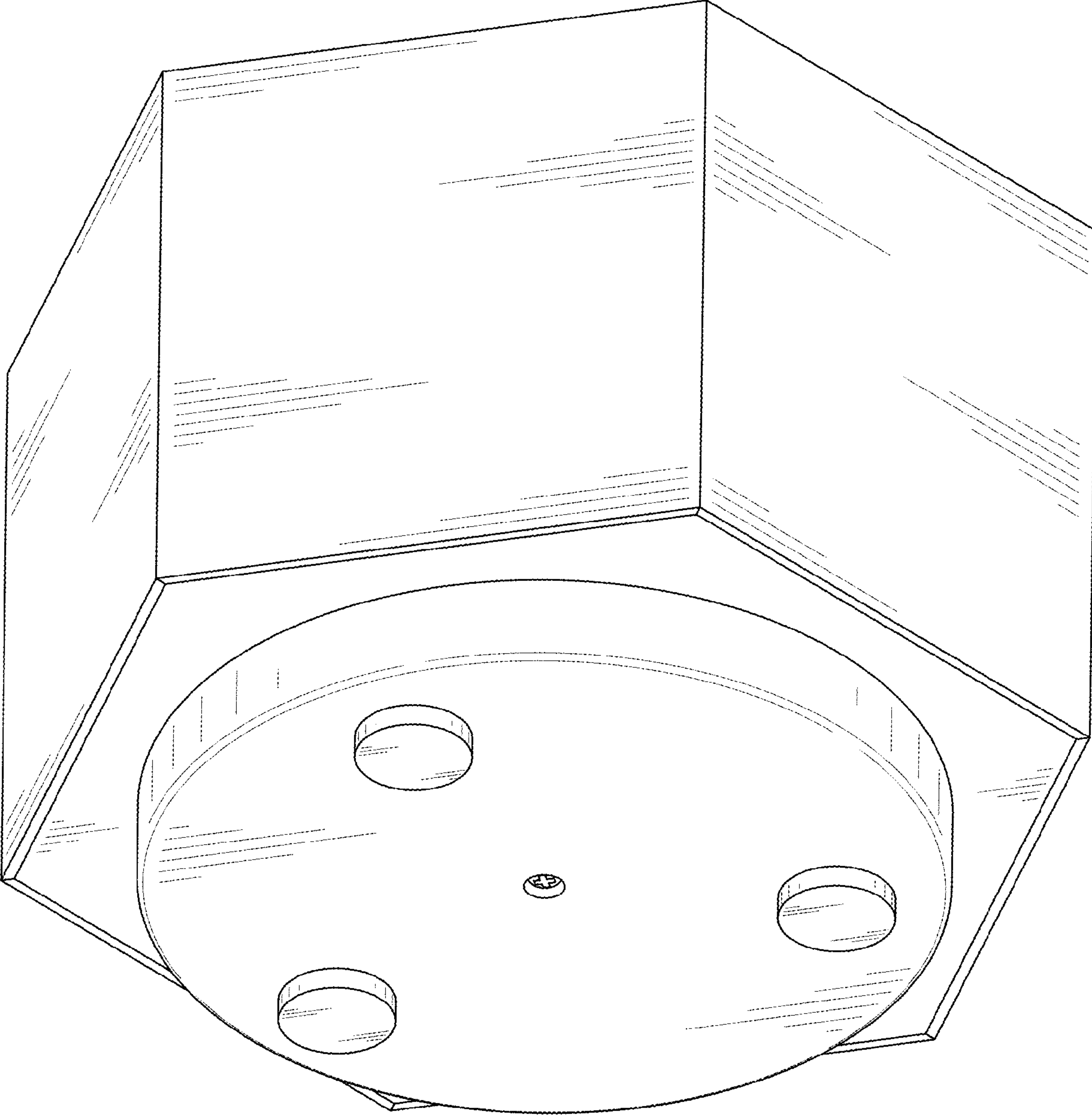

FIG. 2

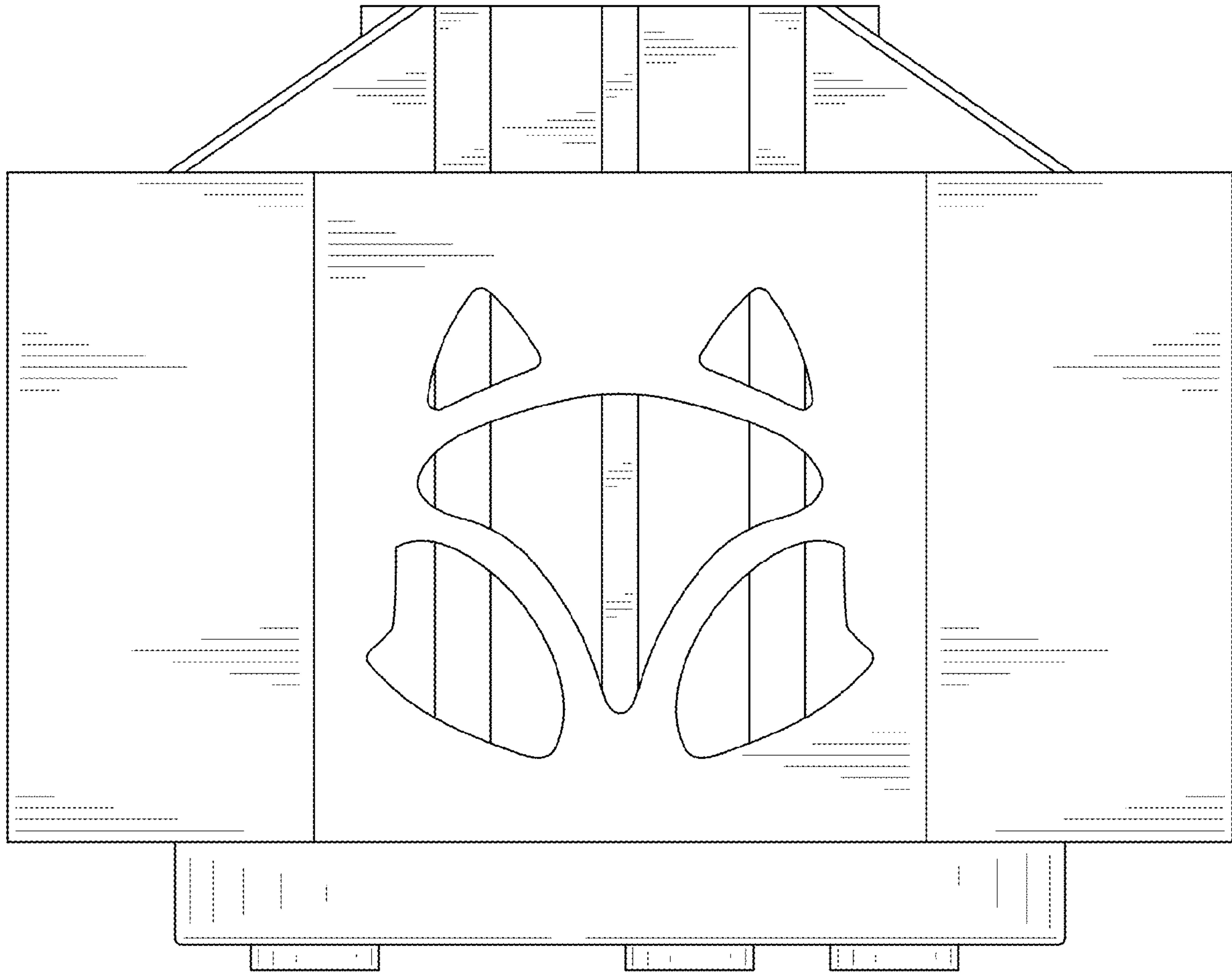

FIG. 3

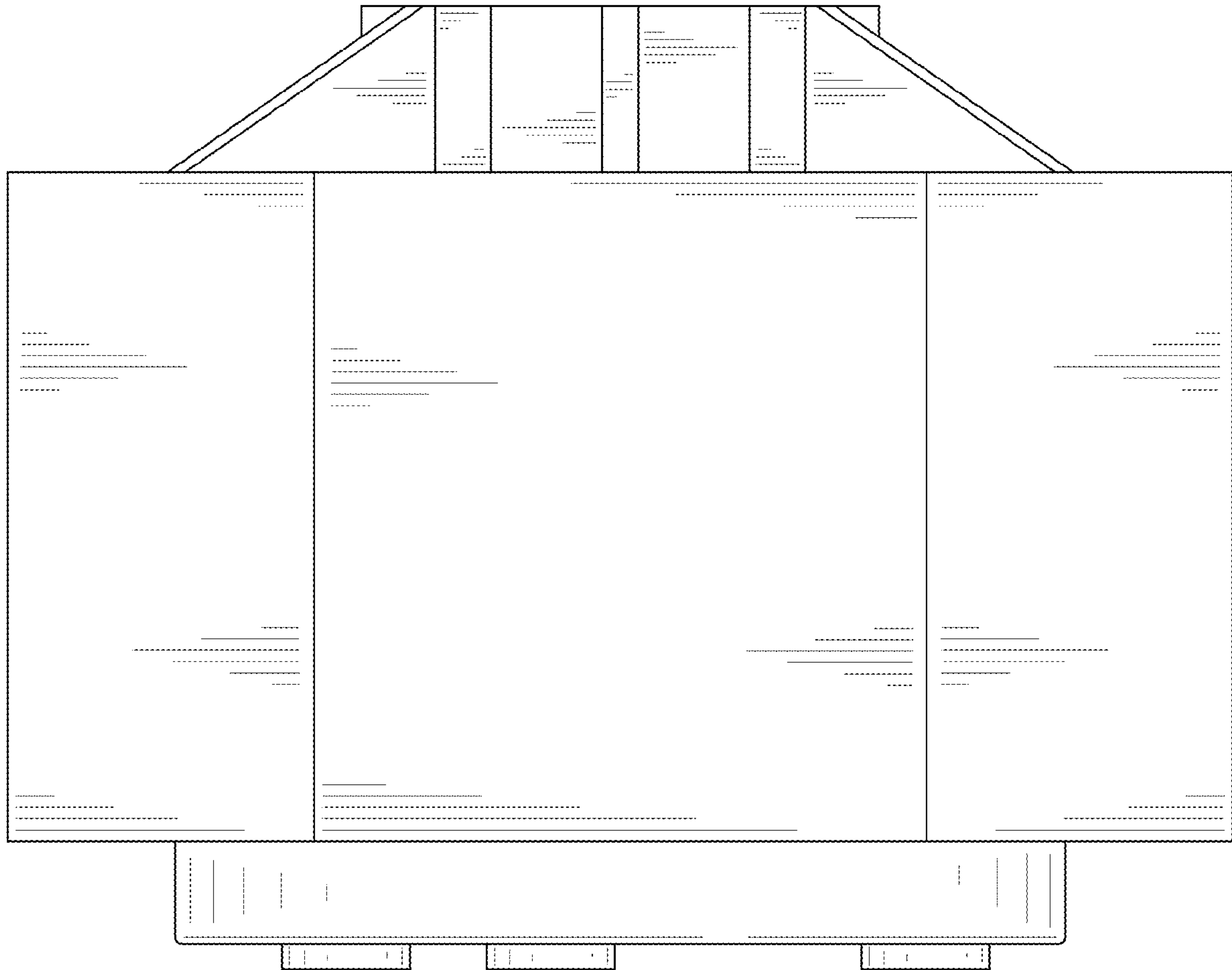

FIG. 4

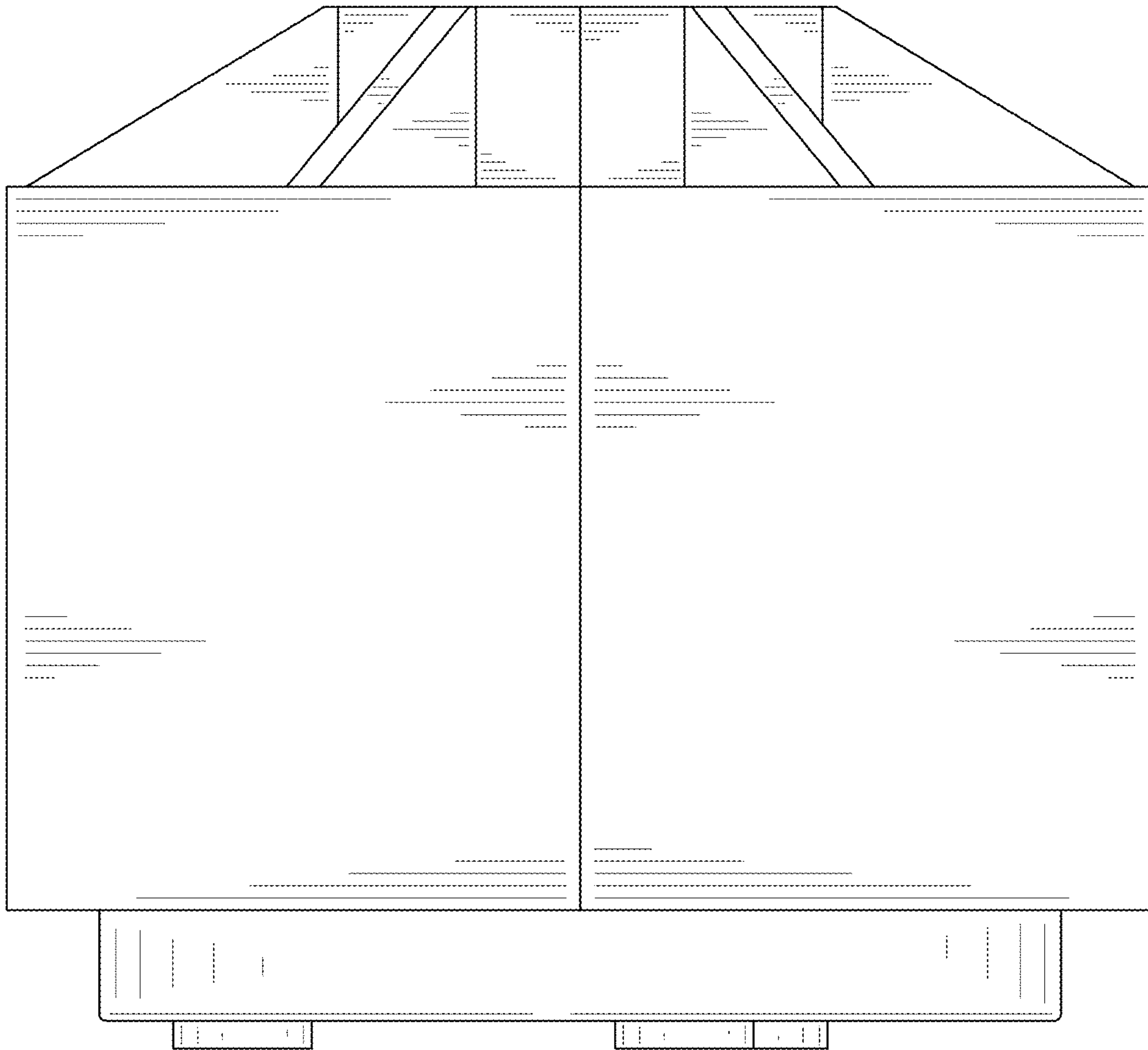

FIG. 5

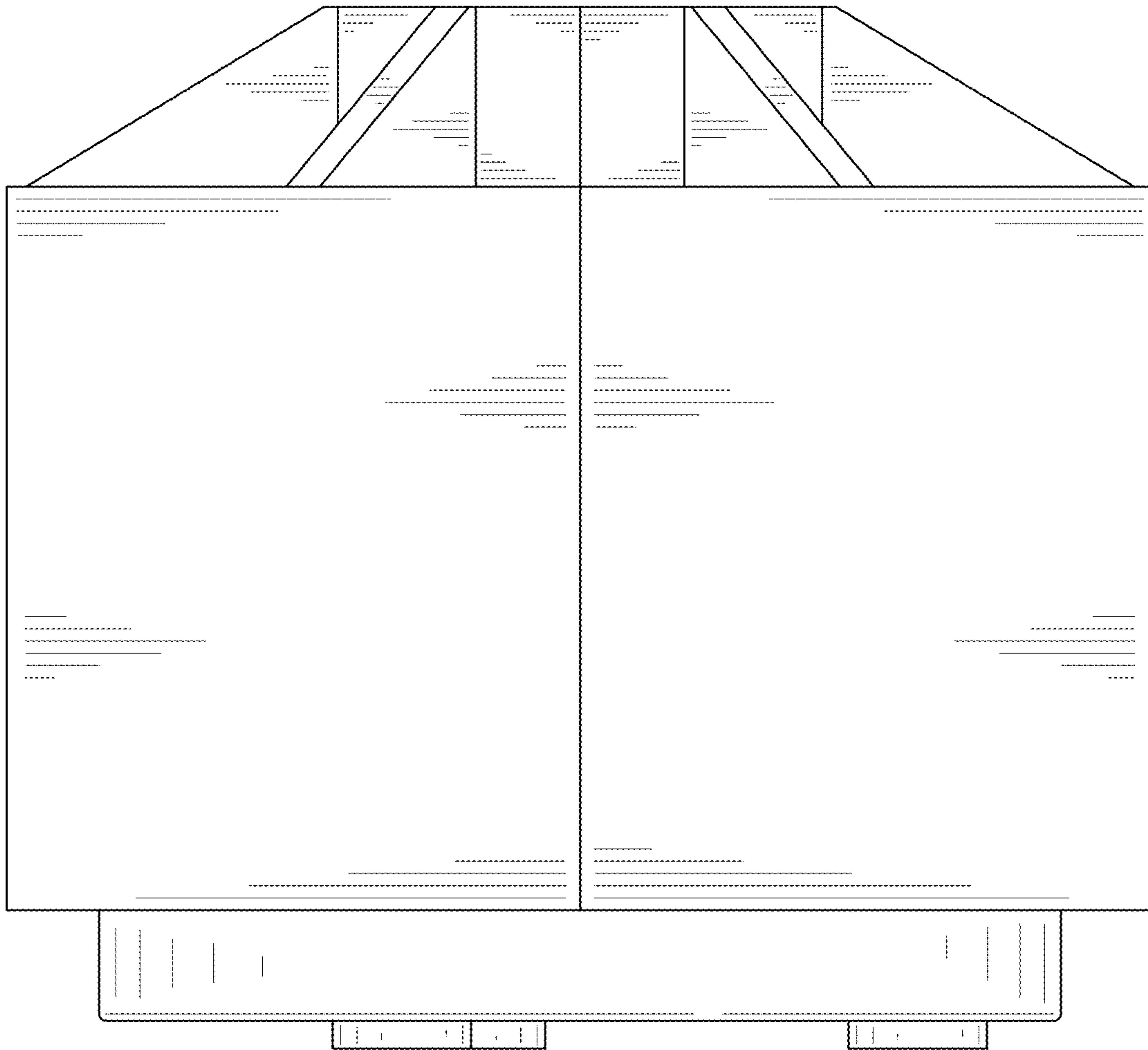

FIG. 6

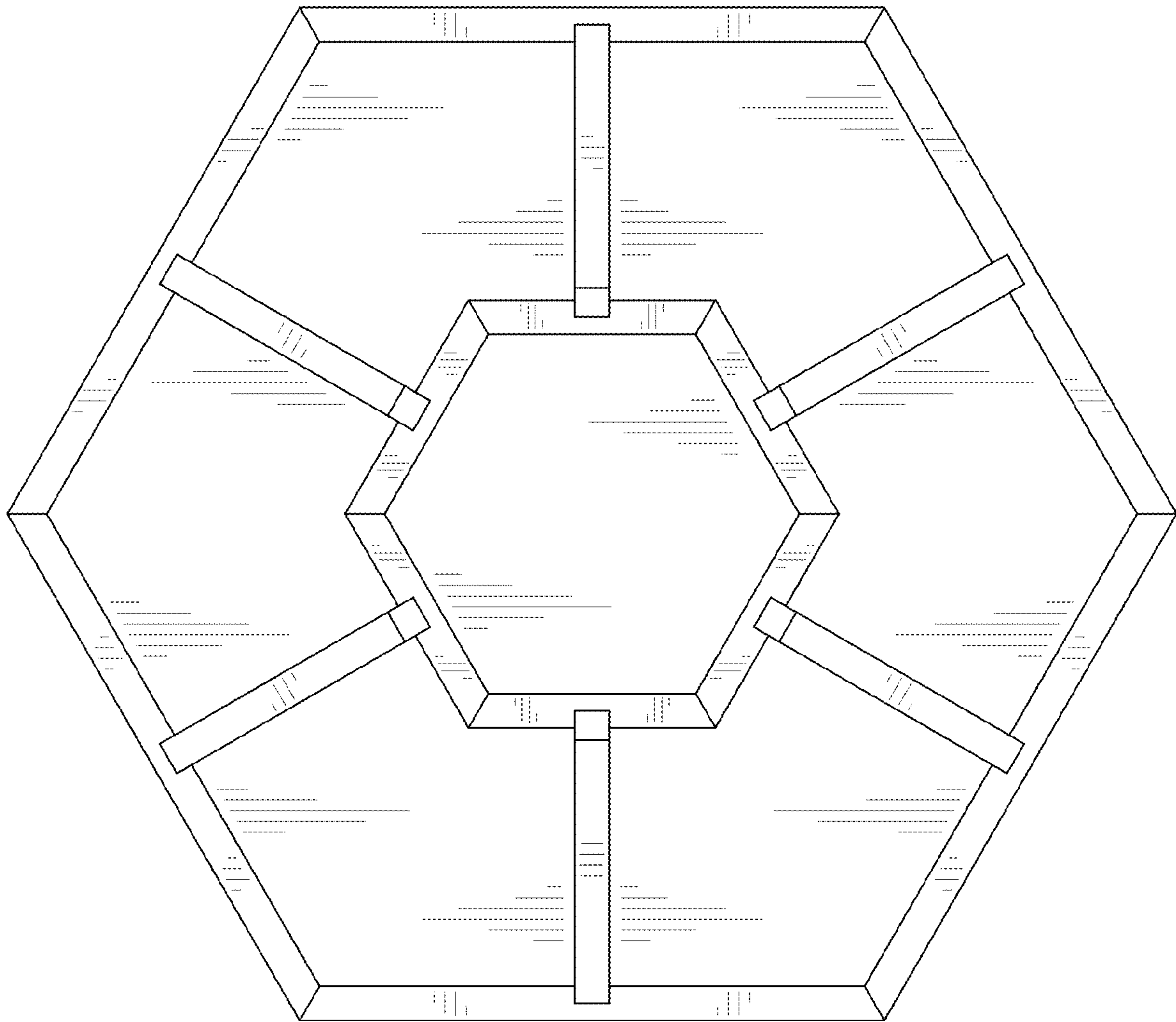

FIG. 7

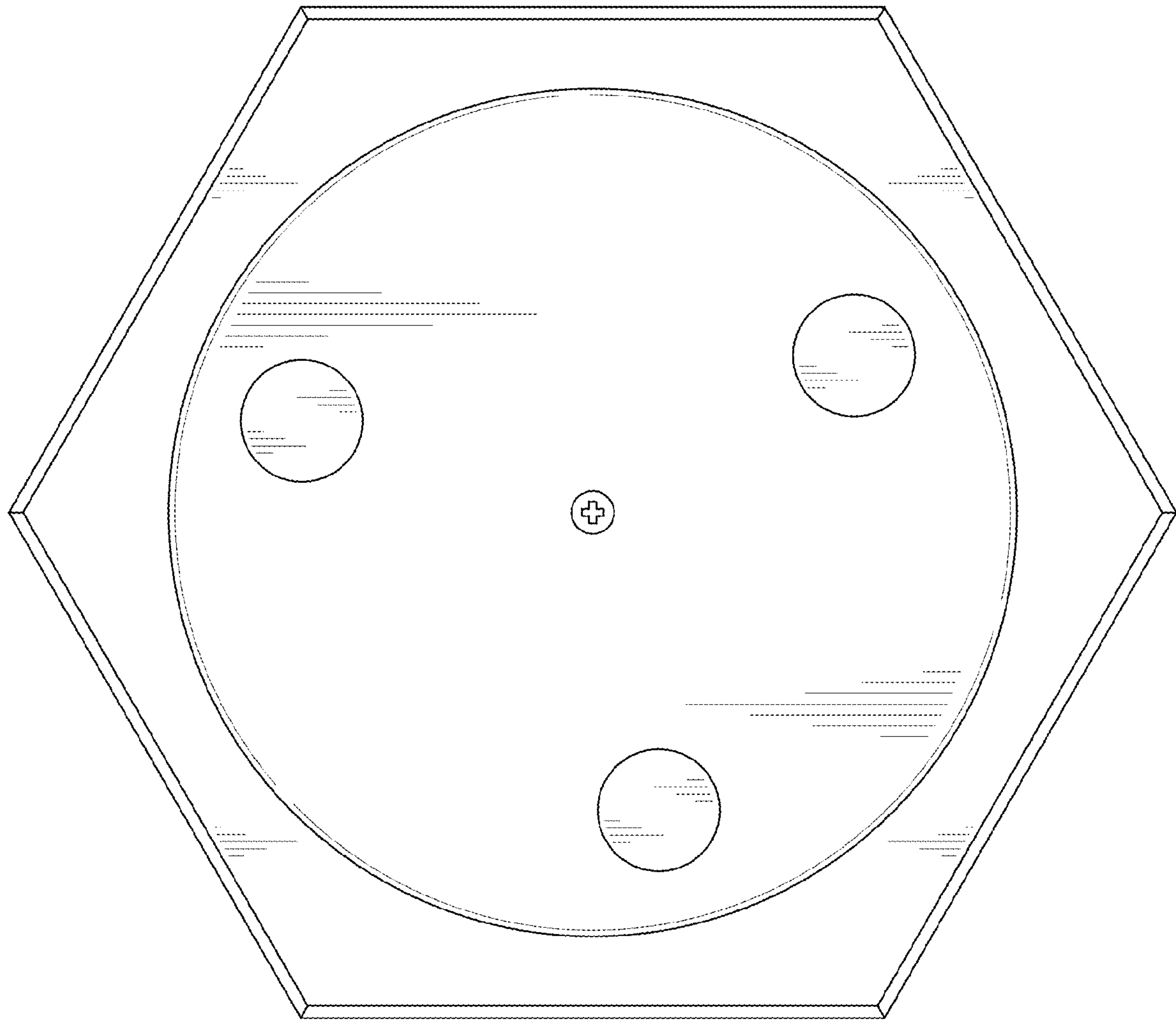

FIG. 8