



US00D986903S

(12) **United States Design Patent** (10) **Patent No.:** **US D986,903 S**
Bolotin et al. (45) **Date of Patent:** **** May 23, 2023**

(54) **ELECTRONIC DEVICE**
(71) Applicant: **ClevX, LLC**, Kirkland, WA (US)
(72) Inventors: **Lev M. Bolotin**, Kirkland, WA (US);
Robert Hubler, San Jose, CA (US)
(73) Assignee: **ClevX, LLC**, Kirkland, WA (US)
(**) Term: **15 Years**

D576,619 S * 9/2008 Udagawa D14/435.1
D582,419 S * 12/2008 Sheba D14/480.5
D585,077 S * 1/2009 Sheba D14/496
D620,018 S * 7/2010 Nan D14/480.7
D624,920 S * 10/2010 Sheppard D14/435.1
D631,885 S * 2/2011 Maier D14/435.1
D656,496 S * 3/2012 Andre D14/496
D670,712 S * 11/2012 Bolotin D14/480.5
D711,389 S * 8/2014 Sun D14/480.5
D800,138 S * 10/2017 Brown D14/480.5
D800,139 S * 10/2017 Brown D14/480.5

(Continued)

(21) Appl. No.: **29/788,341**

(22) Filed: **May 5, 2021**

(51) **LOC (14) Cl.** **14-02**

(52) **U.S. Cl.**
USPC **D14/480.5**

(58) **Field of Classification Search**
USPC D13/139.7, 162, 162.1; D14/125, 238.1,
D14/239, 357, 358, 383, 385, 387, 432,
D14/433, 434, 435, 435.1, 436, 438, 475,
D14/480.1, 480.2, 480.3, 480.4, 480.5,
D14/480.6, 480.7, 483, 484.1, 299;
D21/324, 332, 333
CPC H04N 21/4104; H04N 21/418; H04N 5/40;
H05K 7/00; H05K 9/0015; H05K 5/02;
H05K 5/0269; H05K 5/0278; H05K
5/0273; H05K 5/0256; H05K 5/026;
H05K 5/061; G06F 1/16; G06F 1/1632;
G06F 1/266; G06F 2213/0042; G06F
2213/3814; G06F 2213/40; G06F
2213/4004; G05B 2219/34436; G16H
10/65; G06K 19/07732; G06K 19/077;
G06K 19/07701; G06K 19/07705; G06K
19/07709

See application file for complete search history.

(56) **References Cited**

U.S. PATENT DOCUMENTS

5,383,044 A * 1/1995 Borchardt H04B 10/114
398/154
D563,954 S * 3/2008 Buchanon D14/480.7

FOREIGN PATENT DOCUMENTS

CN 304431970 * 12/2017
DE 202015106365 U1 * 1/2016 G06F 3/0679

Primary Examiner — Marie D. Fast Horse
Assistant Examiner — Josiah D. Parsons
(74) *Attorney, Agent, or Firm* — Schwegman, Lundberg
& Woessner, P.A.

(57) **CLAIM**

The ornamental design for an electronic device, as shown and described.

DESCRIPTION

FIG. 1 is a front view of an electronic device (e.g., a secure electronic data storage device or other electronic storage device), showing our new design.
FIG. 2 is a rear view thereof.
FIG. 3 is a left side view thereof.
FIG. 4 is a right side view thereof.
FIG. 5 is a top view thereof.
FIG. 6 is a bottom view thereof.
FIG. 7 is a top-front-left perspective view thereof.
FIG. 8 is a bottom-front-right perspective view thereof.
FIG. 9 is a top-rear-right perspective view thereof; and,
FIG. 10 is a bottom-rear-left perspective view thereof.
The shade lines show surface contour and not surface ornamentation.

1 Claim, 8 Drawing Sheets

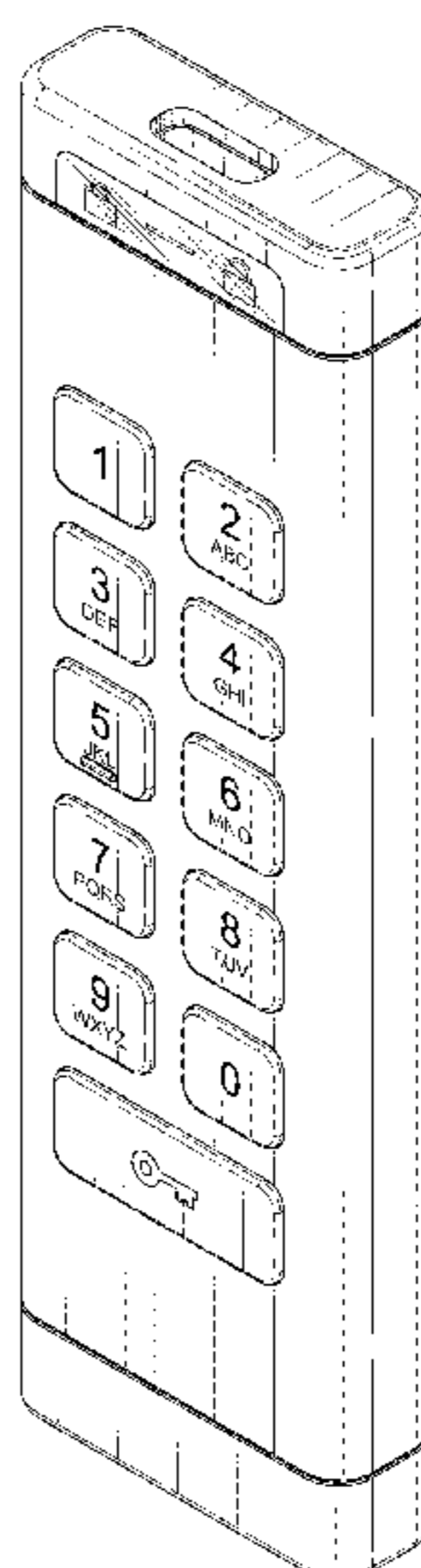

(56)

References Cited

U.S. PATENT DOCUMENTS

D806,089 S * 12/2017 Shim D14/480.5
D845,964 S * 4/2019 Kim D14/480.5
D868,794 S * 12/2019 Jun D14/480.5
D874,470 S * 2/2020 Bolotin D14/480.5
D890,769 S * 7/2020 Bolotin D14/480.5
D909,397 S * 2/2021 Bolotin D14/480.5
D913,583 S * 3/2021 Leon Duque D27/194
D923,010 S * 6/2021 Zhang D14/433
D935,465 S * 11/2021 Wang D14/433
D941,828 S * 1/2022 Kim D14/480.5
D945,983 S * 3/2022 Hwangbo D14/218
2015/0278147 A1* 10/2015 Cerrelli G06F 13/382
710/302
2016/0181717 A1* 6/2016 Kuo H01R 13/44
439/131

* cited by examiner

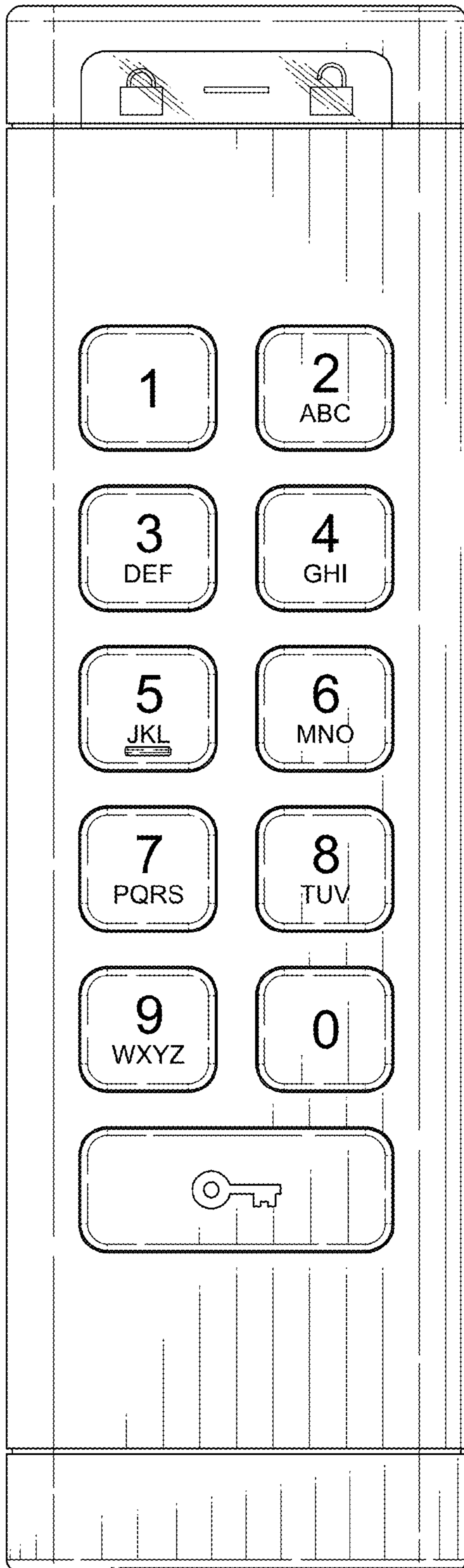

FIG. 1

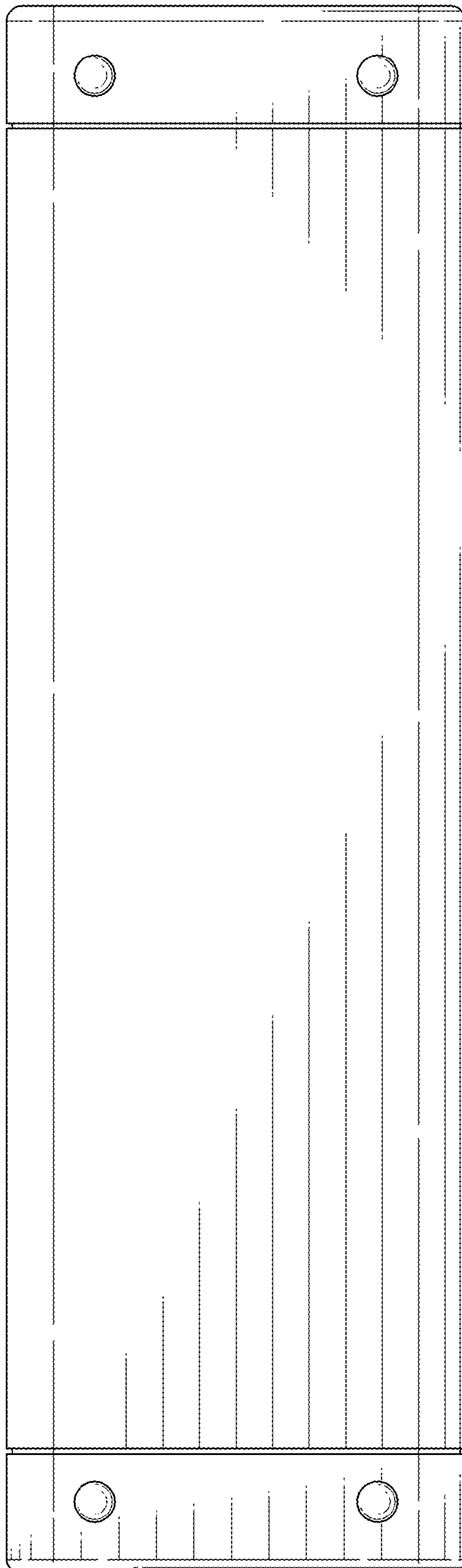

FIG. 2

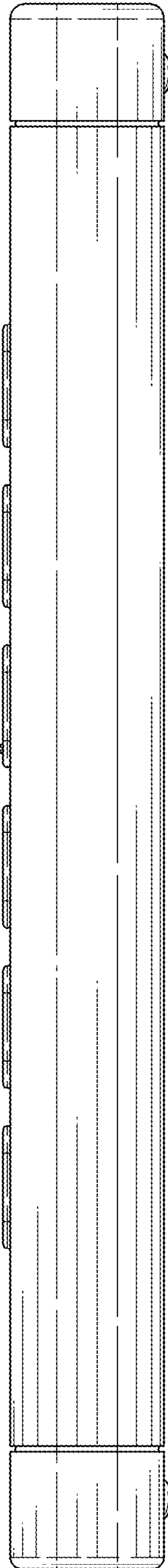

FIG. 3

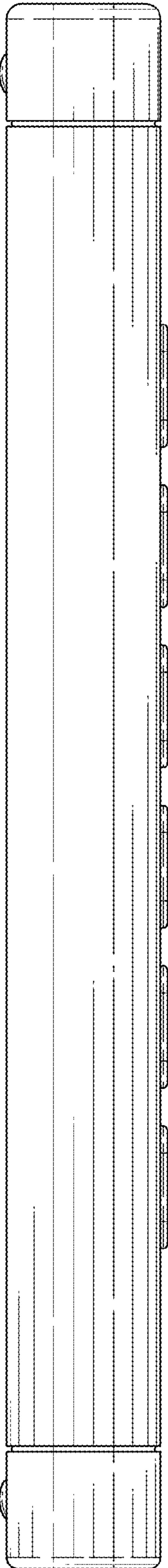

FIG. 4

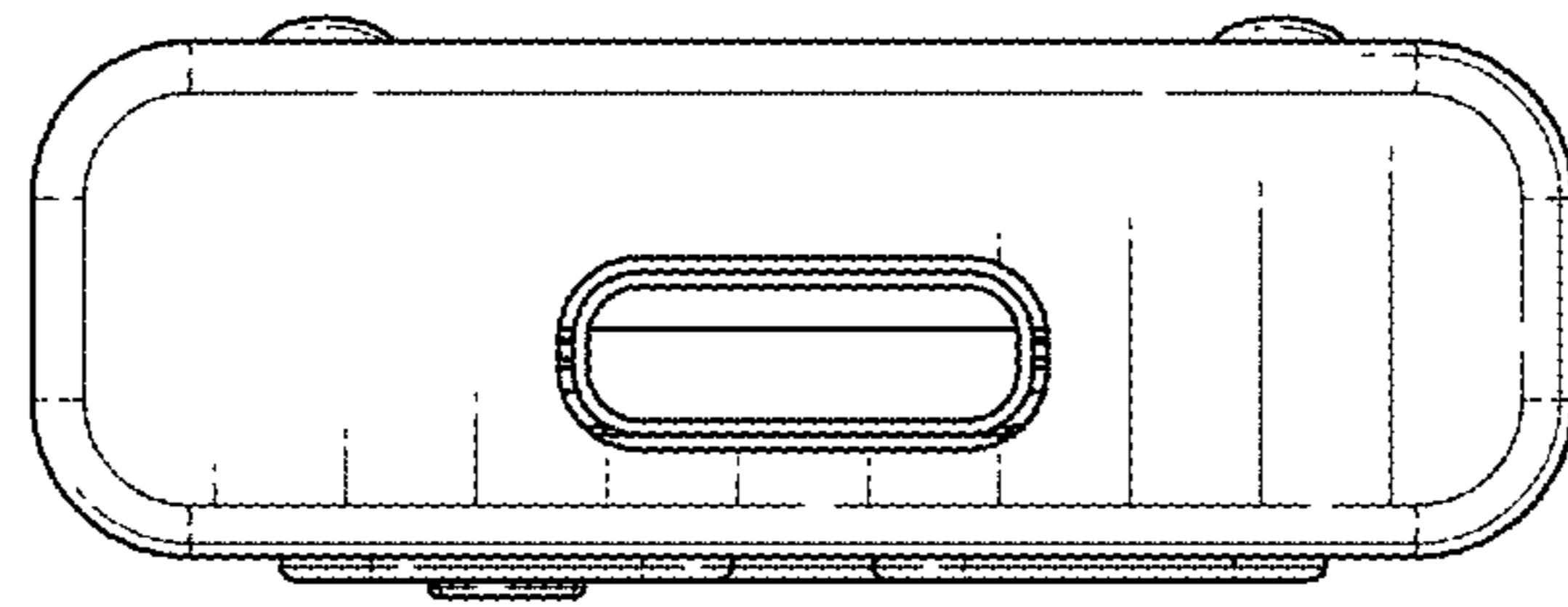

FIG. 5

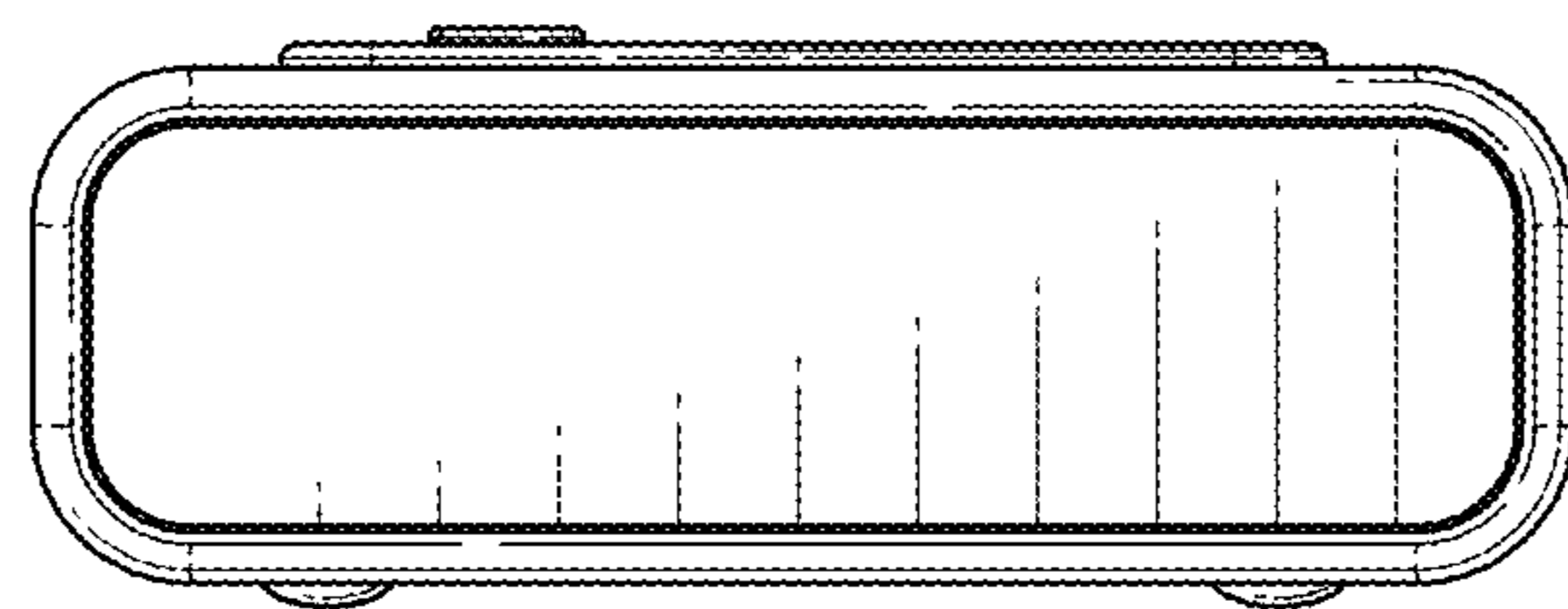

FIG. 6

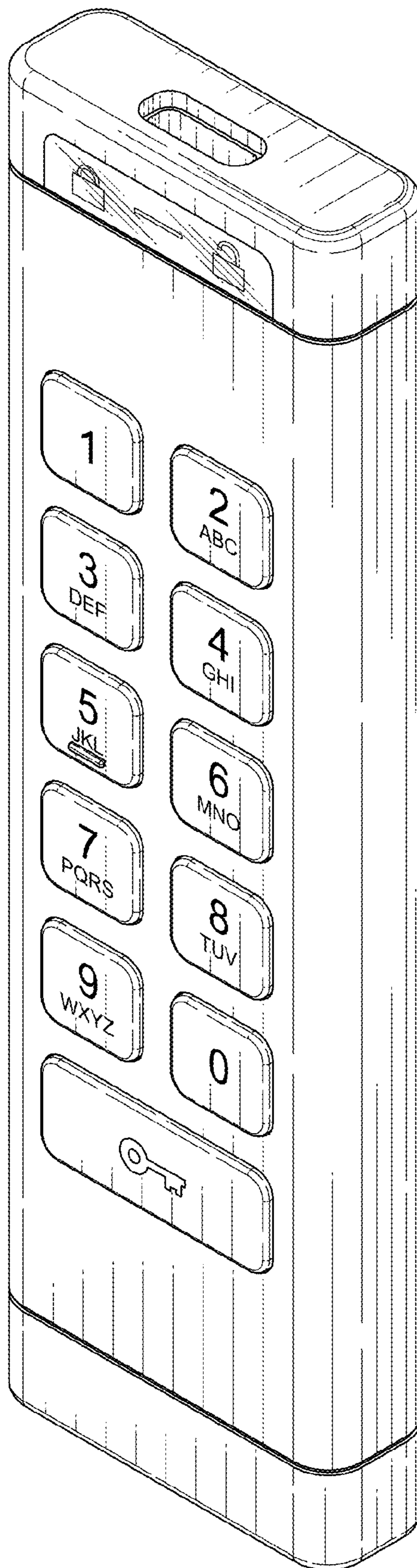

FIG. 7

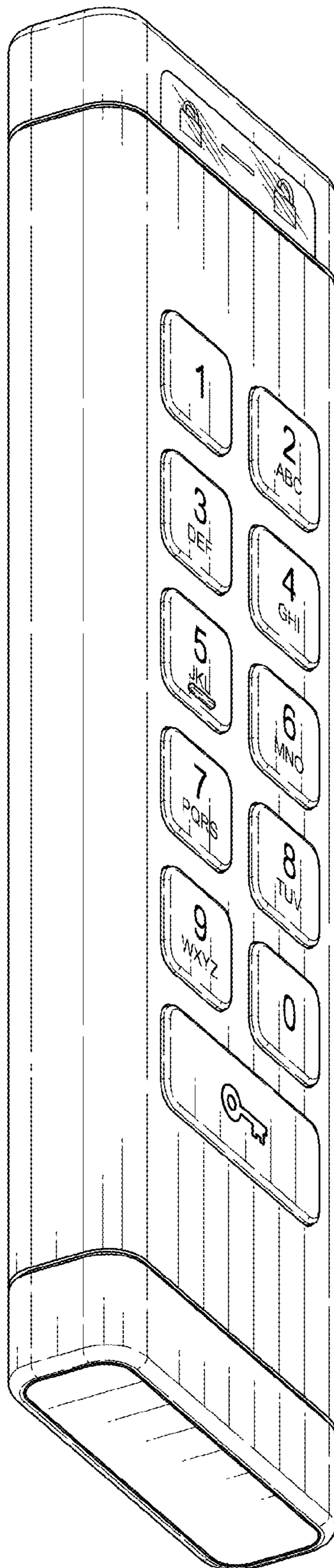

FIG. 8

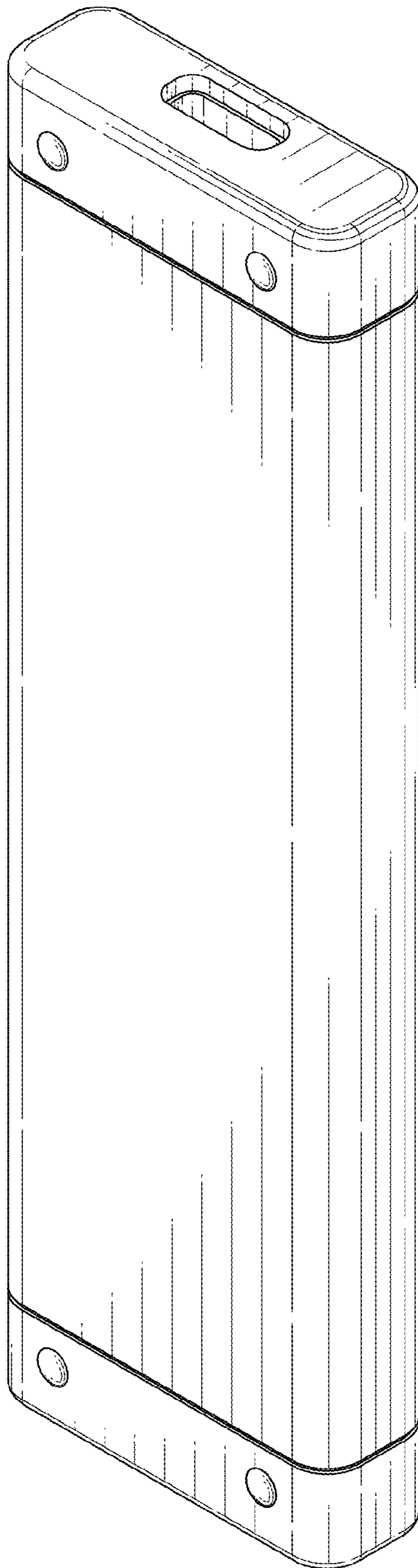

FIG. 9

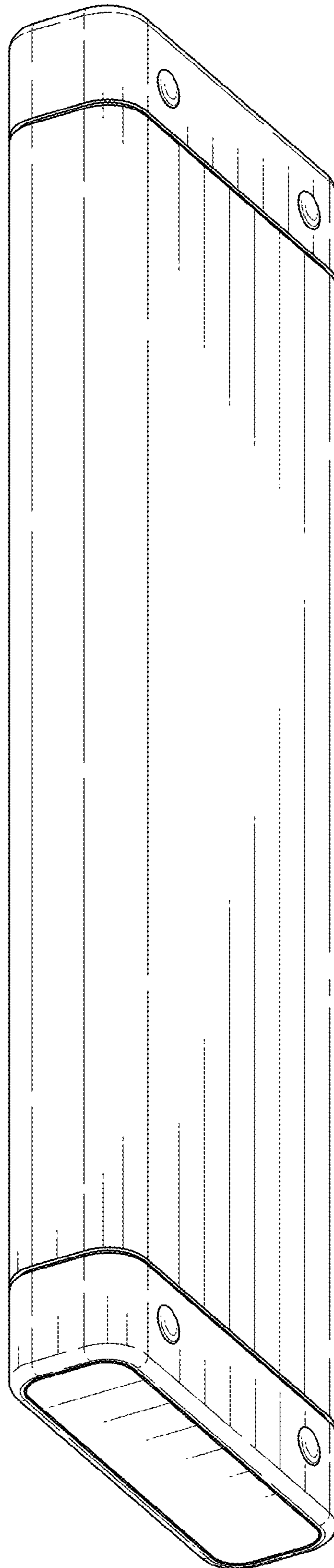

FIG. 10