



US00D986874S

(12) **United States Design Patent**
Myung et al.

(10) **Patent No.:** **US D986,874 S**
(45) **Date of Patent:** **** May 23, 2023**

(54) **CASE FOR PORTABLE ELECTRONIC DEVICE**

(71) Applicant: **Samsung Electronics Co., Ltd.**, Suwon-si (KR)

(72) Inventors: **Jieun Myung**, Suwon-si (KR); **Dahyun Lee**, Suwon-si (KR); **Junho Jin**, Suwon-si (KR); **Bosoon Kang**, Suwon-si (KR); **Jinhoo Lee**, Suwon-si (KR); **Junwon Lee**, Suwon-si (KR); **Namsu Kim**, Suwon-si (KR); **Jiyun Lim**, Suwon-si (KR); **Kangmoon Kim**, Suwon-si (KR)

(73) Assignee: **SAMSUNG ELECTRONICS CO., LTD.**, Suwon-si (KR)

(**) Term: **15 Years**

(21) Appl. No.: **29/812,283**

(22) Filed: **Oct. 20, 2021**

(30) **Foreign Application Priority Data**

Apr. 30, 2021 (KR) 30-2021-0021141

(51) **LOC (14) Cl.** **14-03**

(52) **U.S. Cl.**
USPC **D14/250**

(58) **Field of Classification Search**
USPC D13/107, 108; D14/217, 248, 250–253, D14/426, 432, 434, 440, 447
CPC H04B 1/3888; H04M 1/0283; H04M 1/0202; A45F 2005/028; A45F 2200/0525
See application file for complete search history.

(56) **References Cited**

U.S. PATENT DOCUMENTS

D877,136 S * 3/2020 Lee D14/250
D879,084 S * 3/2020 Lee D14/250

D879,764 S * 3/2020 Lee D14/250
D896,214 S * 9/2020 Lee D14/250
D899,412 S * 10/2020 Lee D14/250
D903,621 S * 12/2020 Kim D14/138 AB
D905,675 S * 12/2020 Lee D14/250
D910,004 S * 2/2021 Lee D14/250
D915,385 S * 4/2021 Lee D14/250
D931,846 S * 9/2021 Lee D14/250
11,116,300 B2 * 9/2021 Mody A45C 13/007
11,121,735 B2 * 9/2021 Kim H04M 1/185

(Continued)

OTHER PUBLICATIONS

This is what folding phone cases will look like—Spigen reveals its first models, publication date Mar. 1, 2019, [online] URL: <https://www.theverge.com/2019/3/1/18246183/samsung-galaxy-fold-foladable-phone-case-screen-protector-spigen-zagg> (Year: 2019).*

(Continued)

Primary Examiner — L. A. Grabenstetter

(74) *Attorney, Agent, or Firm* — McAndrews Held & Malloy, Ltd.

(57) **CLAIM**

The ornamental design for a case for portable electronic device, as shown and described.

DESCRIPTION

FIG. 1 is a front perspective view of a case for portable electronic device showing our new design;
FIG. 2 is a front view thereof;
FIG. 3 is a rear view thereof;
FIG. 4 is a left side view thereof;
FIG. 5 is a right side view thereof;
FIG. 6 is a top plan view thereof;
FIG. 7 is a bottom plan view thereof; and,
FIG. 8 is a rear perspective view thereof.
The dashed broken lines in the figures depict portions of the case for portable electronic device that form no part of the claimed design.

1 Claim, 8 Drawing Sheets

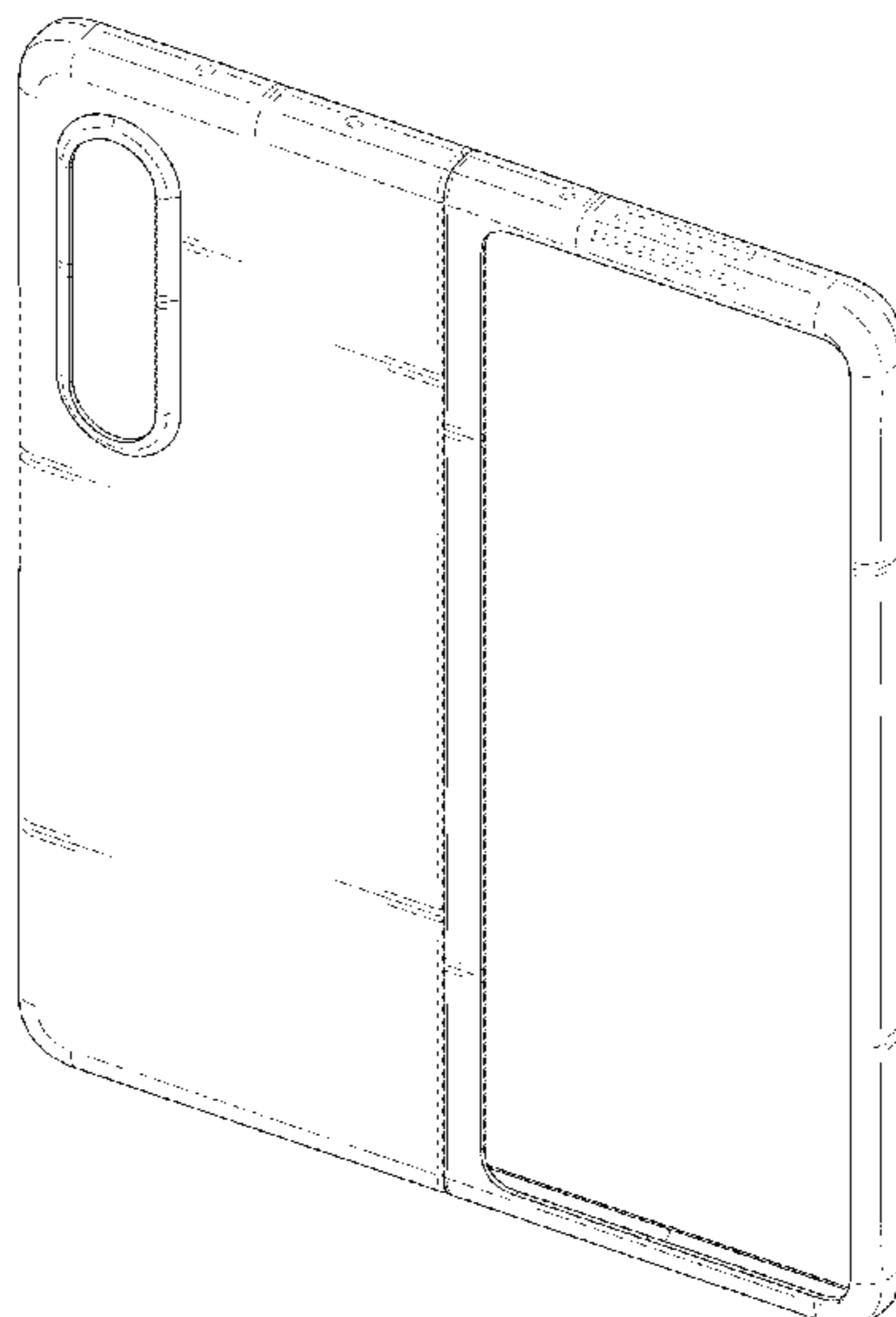

(56)

References Cited

U.S. PATENT DOCUMENTS

D939,492 S * 12/2021 Kim D14/250
D941,281 S * 1/2022 Ji D14/250
D945,988 S * 3/2022 Armstrong D14/250
D970,492 S * 11/2022 Cheng D14/250

OTHER PUBLICATIONS

Official Samsung Galaxy Fold Leather Cover pops up online,
publication date Apr. 18, 2019, [online] URL: <https://androidcommunity.com/official-samsung-galaxy-fold-leather-cover-pops-up-online-20190418/> (Year: 2019).*

* cited by examiner

FIG. 1

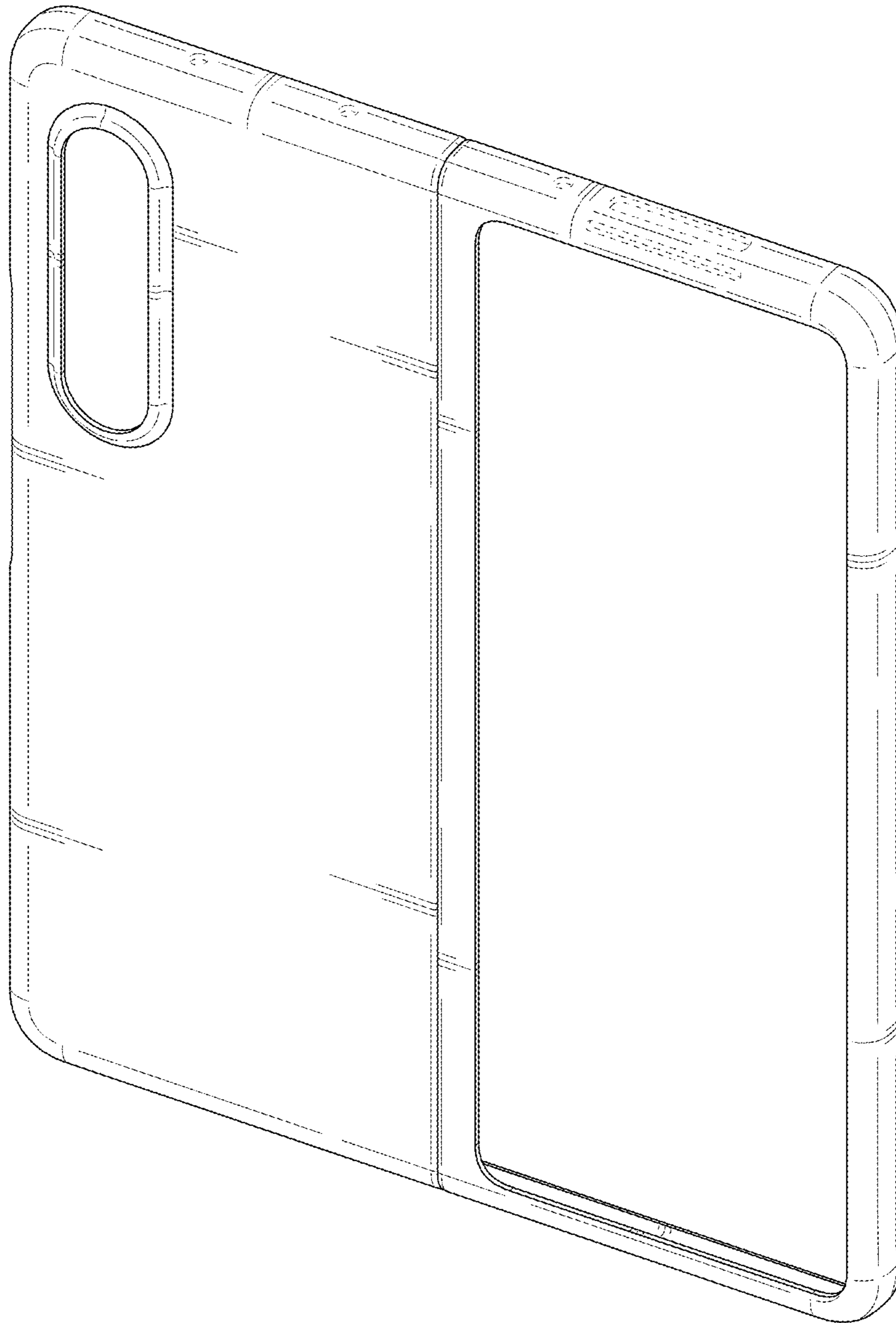

FIG. 2

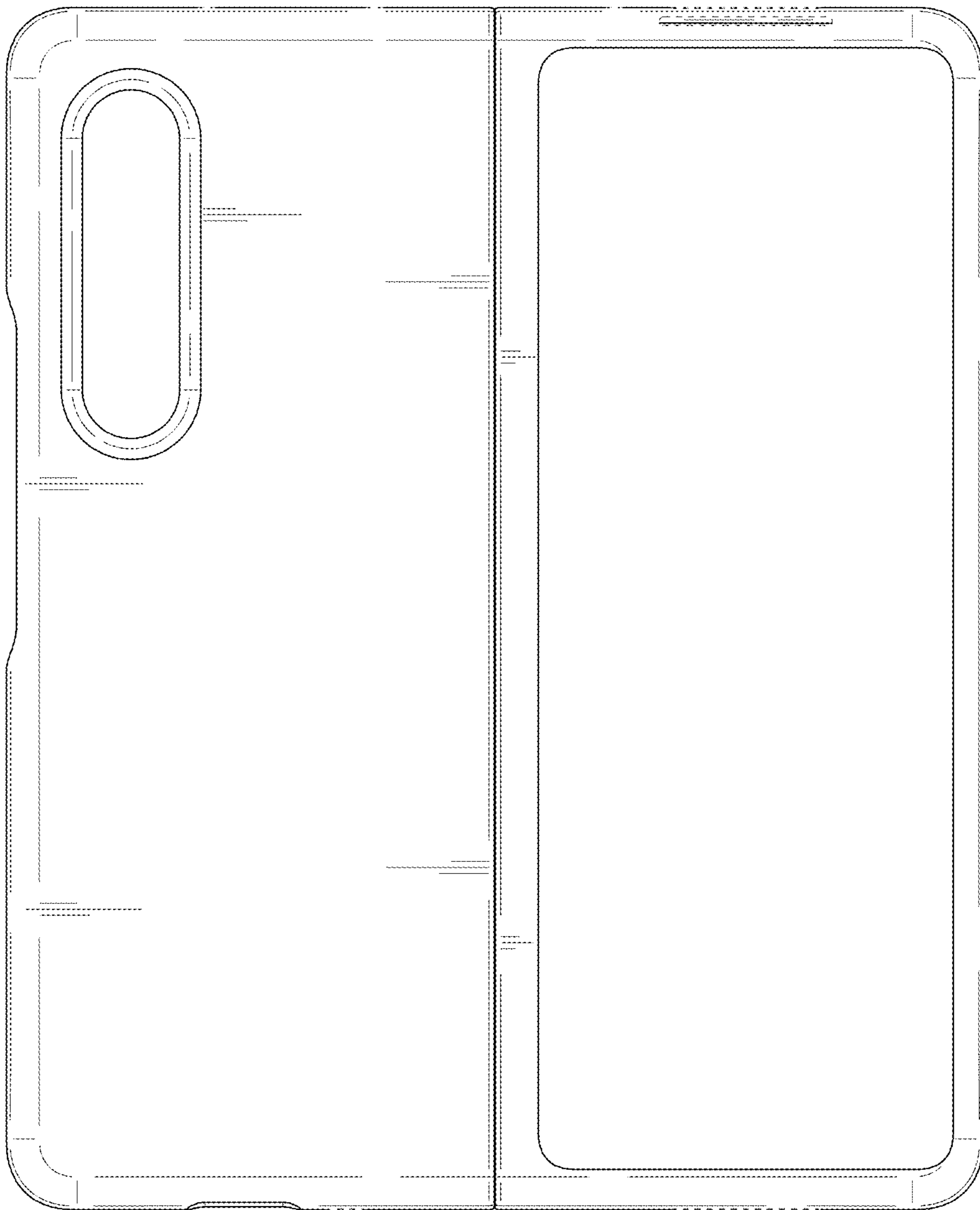

FIG. 3

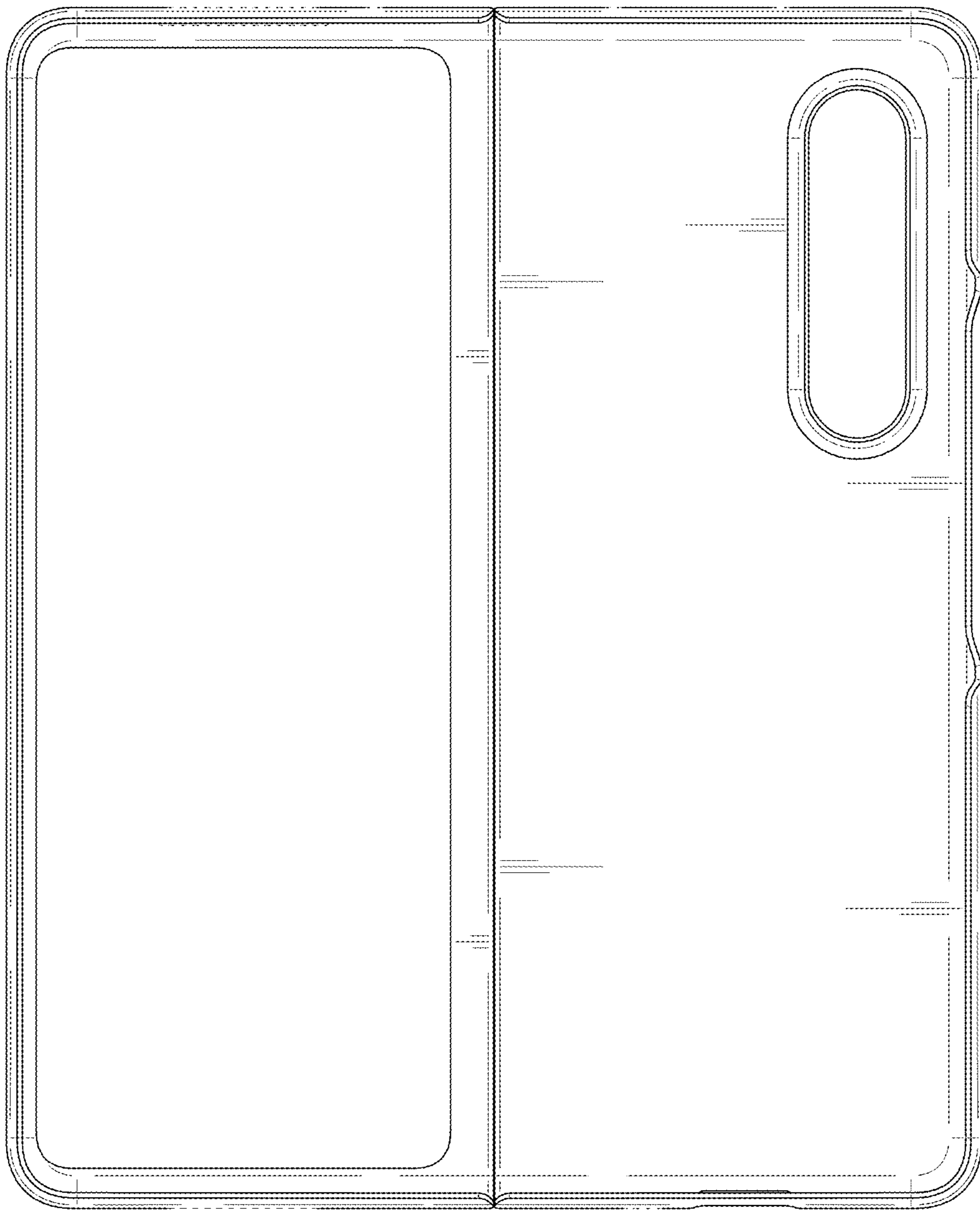

FIG. 4

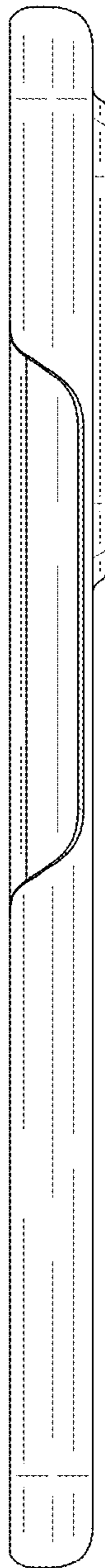

FIG. 5

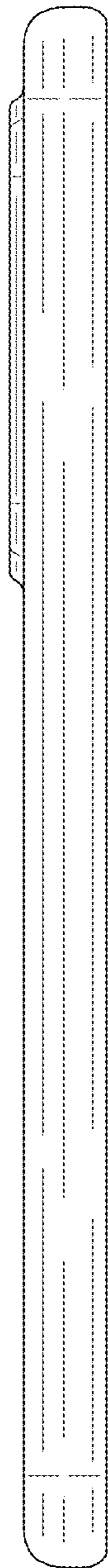

FIG. 6

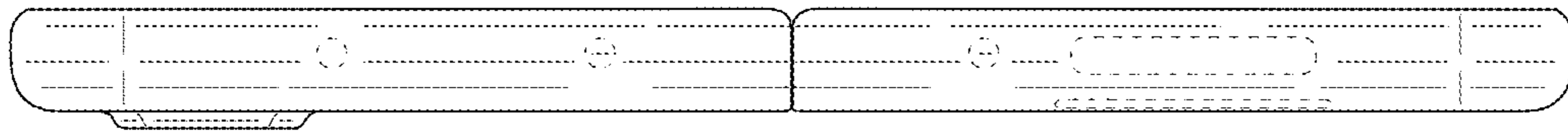

FIG. 7

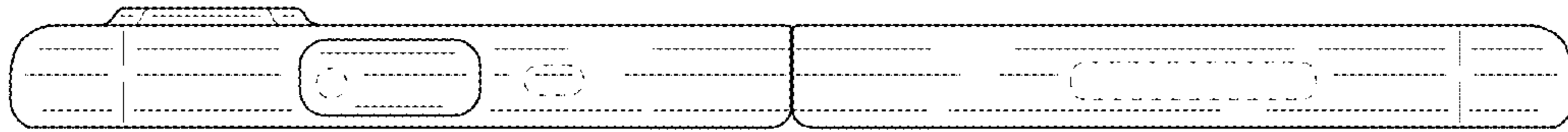

FIG. 8

