



US00D986844S

(12) **United States Design Patent**
Boucquey et al.

(10) **Patent No.:** **US D986,844 S**

(45) **Date of Patent:** **** May 23, 2023**

(54) **HANDHELD COMMUNICATION DEVICE**

(71) Applicant: **MOTOROLA MOBILITY LLC**,
Chicago, IL (US)

(72) Inventors: **Thomas Boucquey**, Chicago, IL (US);
Matias Conti, Guangdong (CN)

(73) Assignee: **Motorola Mobility LLC**, Chicago, IL
(US)

(**) Term: **15 Years**

(21) Appl. No.: **29/735,731**

(22) Filed: **May 22, 2020**

(51) **LOC (14) Cl.** **14-03**

(52) **U.S. Cl.**
USPC **D14/138 G**

(58) **Field of Classification Search**
USPC D14/496, 138 R, 138 AA, 138 AB,
D14/138 AC, 138 AD, 138 C, 138 G,
D14/203.1, 203.3, 203.4, 203.7, 299;
D13/103, 107; D10/50
CPC G06F 3/041; G06F 3/0412; G06F 3/0488;
G06F 3/04883; G06F 1/1613; G06F
1/1686; G06F 1/1626; G06F 2200/1633;
H04M 1/0283; H04M 1/0279; H04M
1/0202; H04M 1/0266; H04M 1/027
See application file for complete search history.

(56) **References Cited**

U.S. PATENT DOCUMENTS

- D662,486 S * 6/2012 Faoro D14/138 G
- D669,053 S * 10/2012 Forsyth D14/138 G
- D711,339 S * 8/2014 Yang G06F 1/1686
D14/138 G
- D729,188 S * 5/2015 Nilsen D14/138 G
- D784,280 S * 4/2017 Kim D14/138 AA
- D835,597 S * 12/2018 Lee G06F 1/1686
D14/138 G
- D946,547 S * 3/2022 Kim D14/138 G

- D950,512 S * 5/2022 Zhu D14/138 G
- D951,895 S * 5/2022 Son D14/138 G
- D951,930 S * 5/2022 Son D14/248
- D954,672 S * 6/2022 Akana D14/138 G
- D958,102 S * 7/2022 Yu D14/138 G
- D960,852 S * 8/2022 Ryu D14/138 G
- D967,048 S * 10/2022 Lin D14/138 G
- D967,049 S * 10/2022 Shin D14/138 G
- D967,789 S * 10/2022 Ryu D14/138 G

OTHER PUBLICATIONS

Motorola's new \$1,000 Edge Plus phone, www.businessinsider.com, Apr. 22, 2020. <https://www.businessinsider.com/guides/tech/motorola-edge-plus-price-release-date> (Year: 2020).*

Motorola's Edge Plus, www.theverge.com, Apr. 30, 2020. <https://www.theverge.com/2020/4/30/21241919/motorola-edge-plus-review-android-phone-screen-camera-specs-price> (Year: 2020).*

Motorola Edge Plus hands-on, www.youtube.com, Apr. 22, 2020. <https://www.youtube.com/watch?v=IWF2QUCftBc> (Year: 2020).*

* cited by examiner

Primary Examiner — Llorelys Martinez

Assistant Examiner — Kwabena A. Ankobiah

(74) *Attorney, Agent, or Firm* — Isidore PLLC

(57) **CLAIM**

The ornamental design for a handheld communication device, as shown and described.

DESCRIPTION

FIG. 1 is a front perspective view of a handheld communication device showing our new design;
 FIG. 2 is a rear perspective view thereof;
 FIG. 3 is a front view thereof;
 FIG. 4 is a rear view thereof;
 FIG. 5 is a side view thereof;
 FIG. 6 is an opposite side view thereof;
 FIG. 7 is a top view thereof; and,
 FIG. 8 is a bottom view thereof.

1 Claim, 6 Drawing Sheets

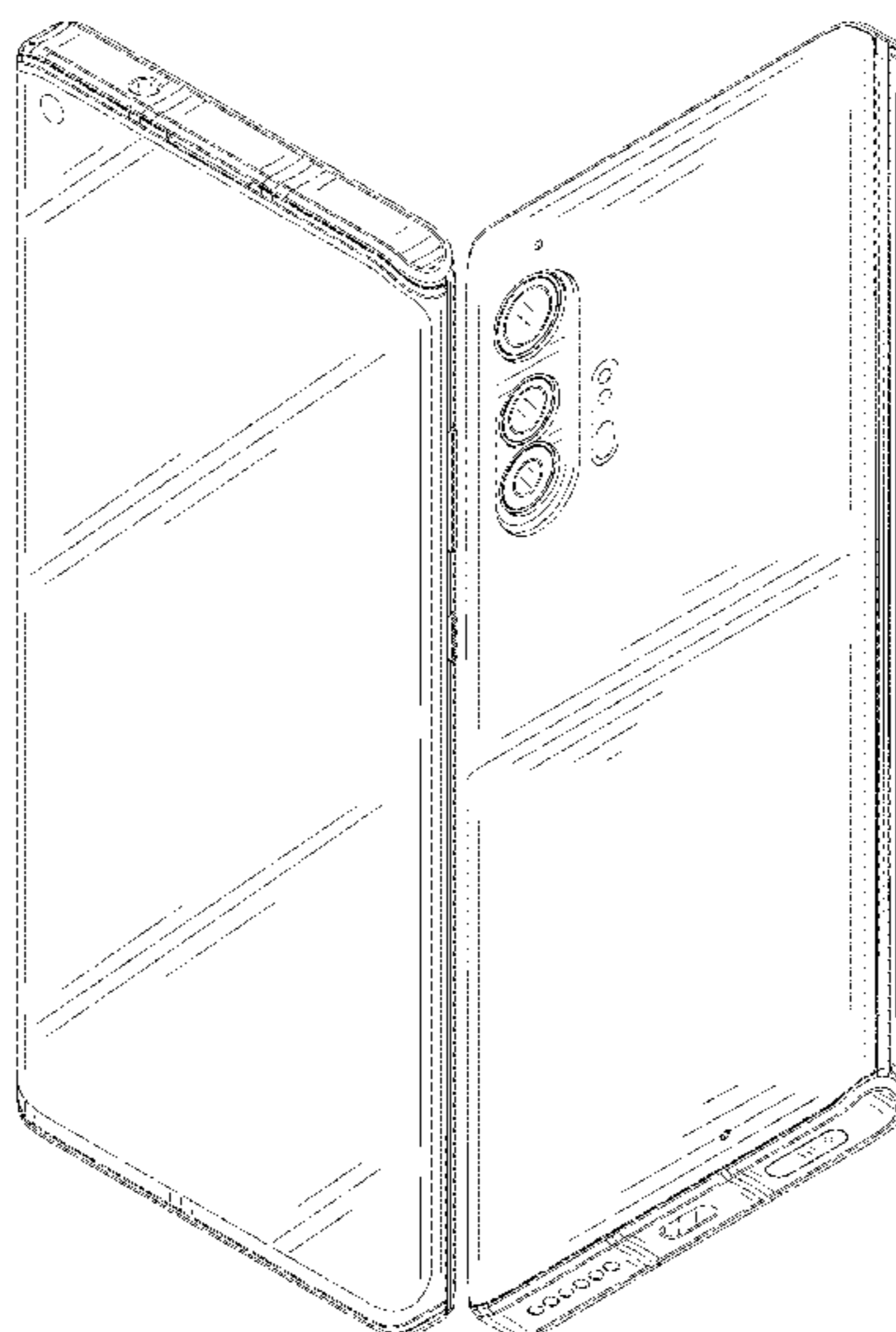

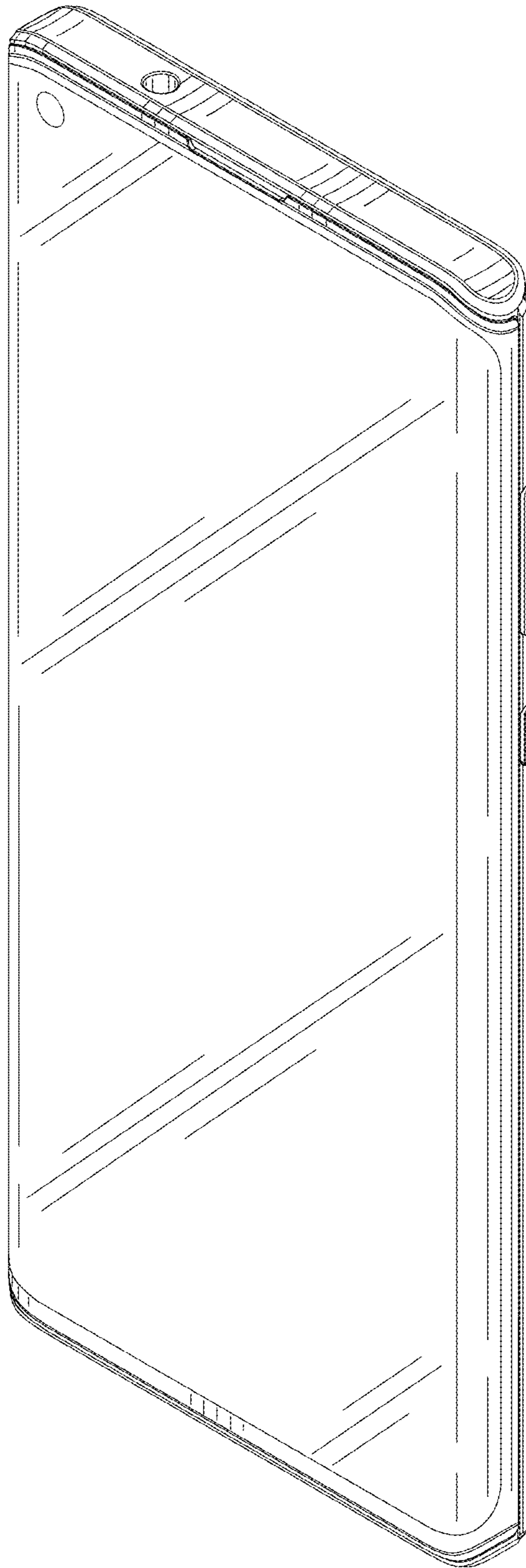

FIG. 1

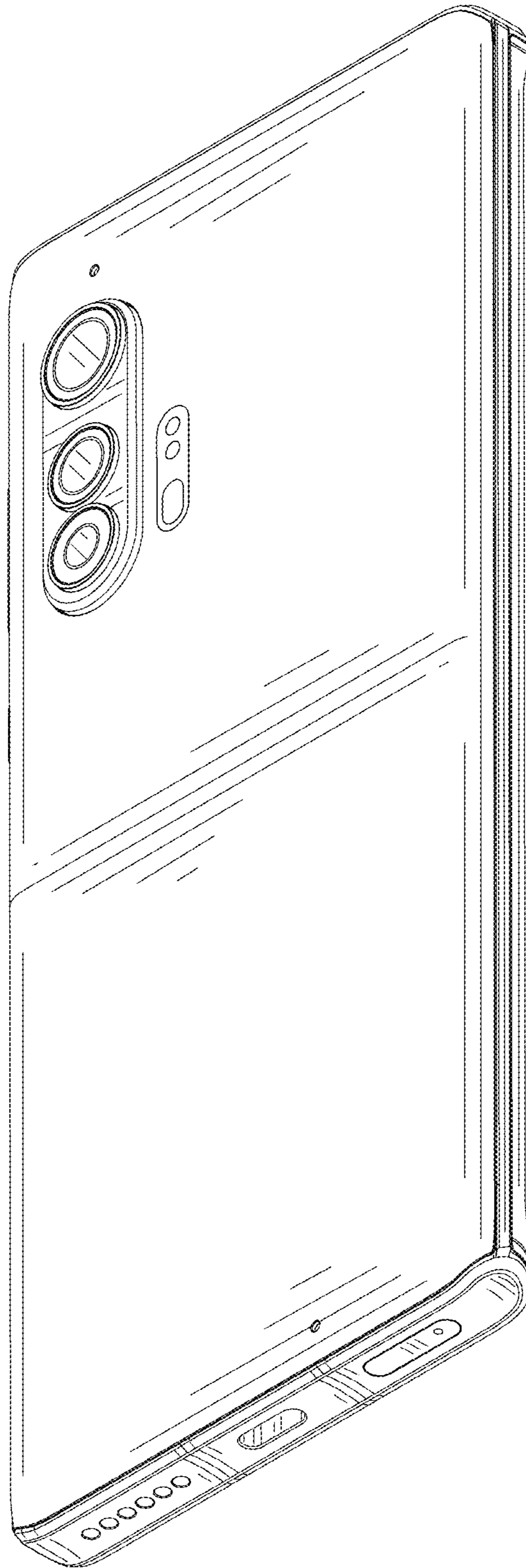

FIG. 2

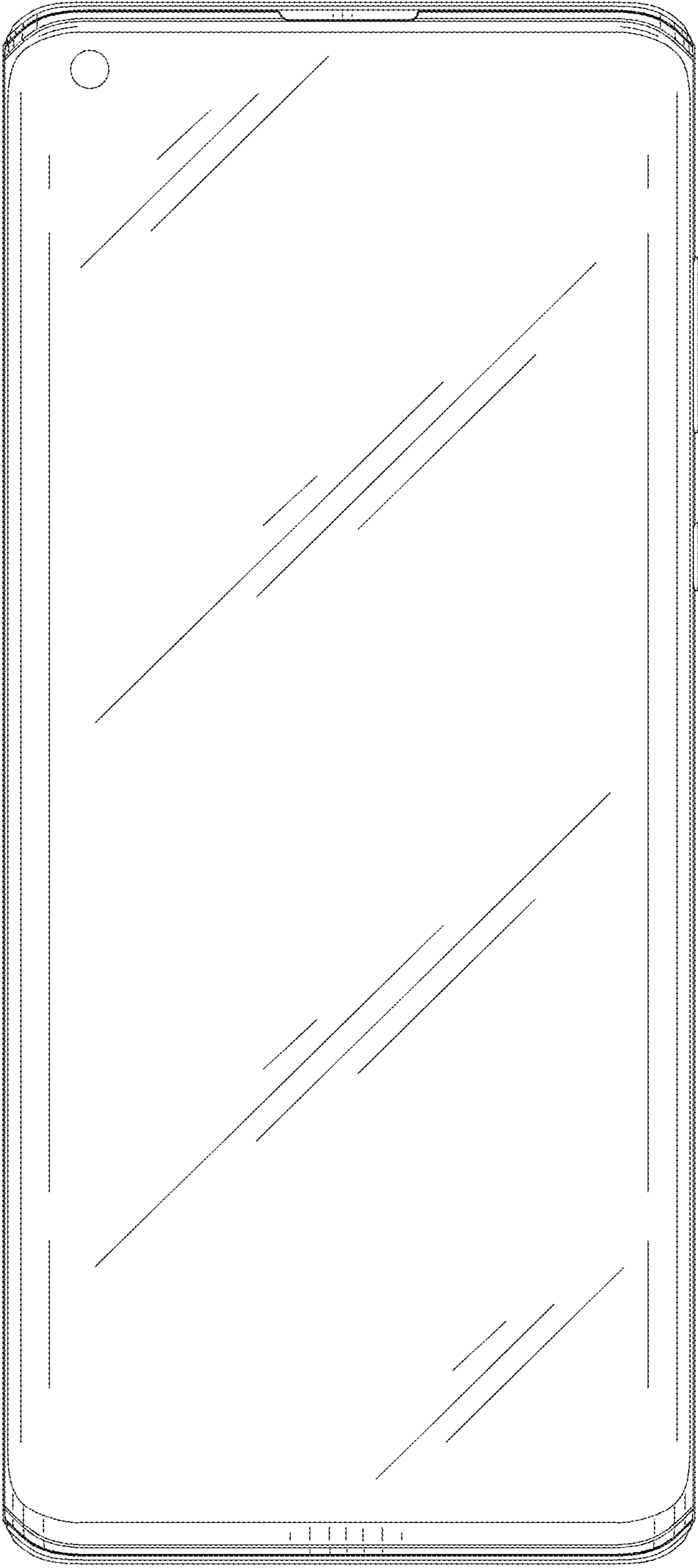

FIG. 3

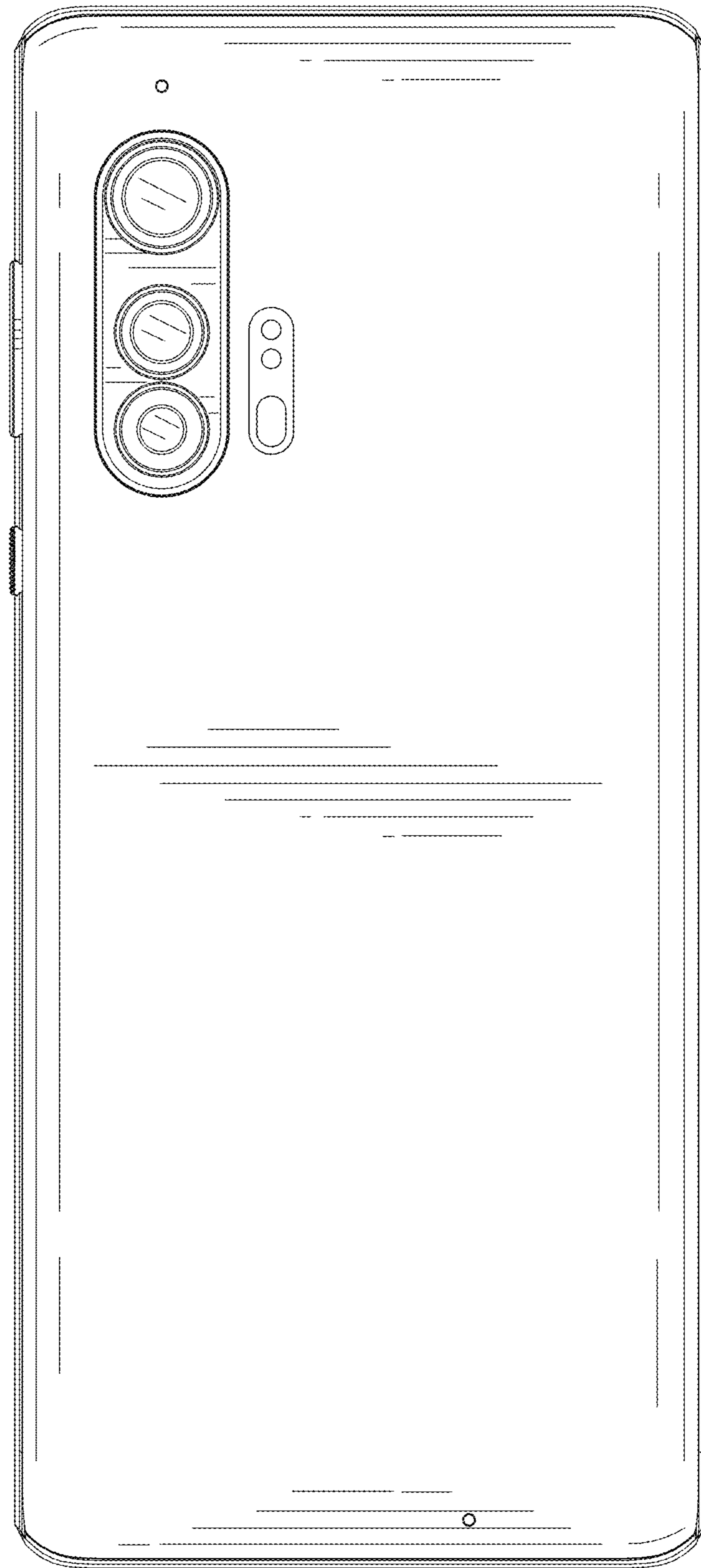

FIG. 4

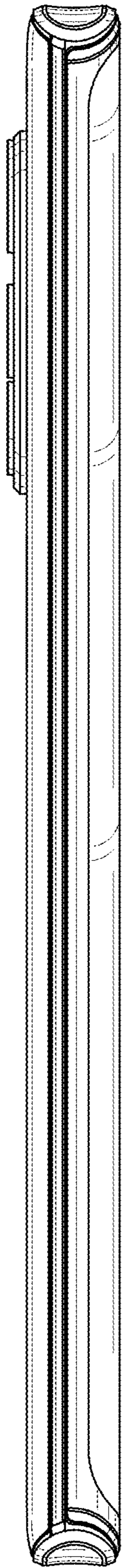

FIG. 5

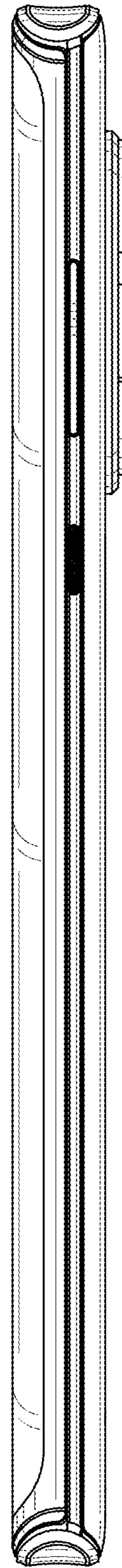

FIG. 6

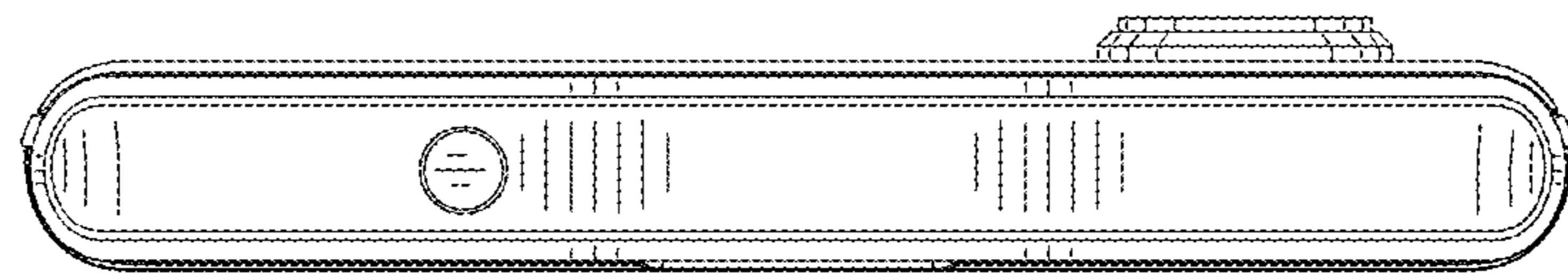

FIG. 7

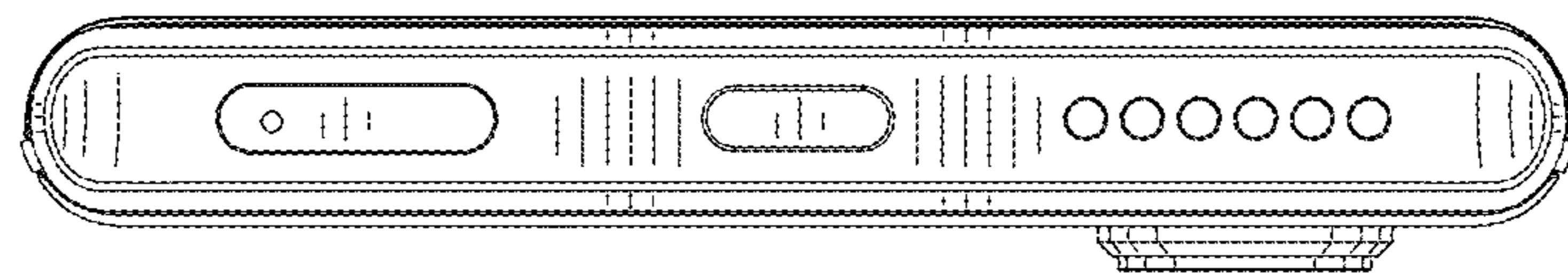

FIG. 8