



US00D986730S

(12) **United States Design Patent** (10) **Patent No.:** **US D986,730 S**  
**Okoroafor et al.** (45) **Date of Patent:** **\*\* May 23, 2023**

(54) **PACKAGE**

(71) Applicant: **MCCORMICK & COMPANY, INC.**,  
Hunt Valley, MD (US)

(72) Inventors: **Michael O. Okoroafor**, Cockeysville,  
MD (US); **Erik Holm**, Phoenix, MD  
(US); **Peter Brian Clarke**, Newtown,  
CT (US); **James E. McCay**, Fairfield,  
CT (US); **Sean Evelich**, Hamden, CT  
(US); **Corey James Marchetti**,  
Seymour, CT (US)

(73) Assignee: **MCCORMICK & COMPANY, INC.**,  
Hunt Valley, MD (US)

(\*\*) Term: **15 Years**

(21) Appl. No.: **29/752,036**

(22) Filed: **Sep. 24, 2020**

(51) **LOC (14) Cl.** ..... **09-03**

(52) **U.S. Cl.**  
USPC ..... **D9/425; D9/707**

(58) **Field of Classification Search**  
USPC ..... D9/702-714, 730-731, 695-699, 550,  
D9/551, 521-522, 416, 414, 56, 425;  
D28/5, 7

(Continued)

(56) **References Cited**

**U.S. PATENT DOCUMENTS**

5,111,932 A \* 5/1992 Campbell ..... B65D 75/48  
206/229

D350,690 S \* 9/1994 Herro ..... D9/696  
(Continued)

**FOREIGN PATENT DOCUMENTS**

GB 6126096 \* 3/2021  
WO 2007/082034 7/2007

**OTHER PUBLICATIONS**

Heinz Ketchup Dip & Squeeze Single Serve Packets (0.95 oz  
Packets, Pack of 500) Online, published date N/A. Retrieved on

Aug. 17, 2022 from URL: <https://www.amazon.com/Heinz-Ketchup-Dip-N-Squeeze-Pack-500/dp/B00SW257AG>.\*

(Continued)

*Primary Examiner* — Jae Liang  
*Assistant Examiner* — Royner Mendoza  
(74) *Attorney, Agent, or Firm* — Greenblum & Bernstein  
P.L.C.

(57) **CLAIM**

We claim the ornamental design for a package, as shown and  
described.

**DESCRIPTION**

FIG. 1 is a front, right and top perspective view of a first  
embodiment of a package shown with the lid or cover  
removed for ease of illustration;

FIG. 2 is a top view thereof;

FIG. 3 is a bottom view thereof;

FIG. 4 is a right side view thereof;

FIG. 5 is a left side view thereof;

FIG. 6 is a front view thereof; and

FIG. 7 is a rear view thereof;

FIG. 8 is a front, right and top perspective view of the  
package shown in FIG. 1 with a lid or cover installed  
thereon;

FIG. 9 is a front, right and top perspective view thereof  
shown with a portion of the lid or cover being lifted off or  
raised at an angle at one end;

FIG. 10 is a top view thereof;

FIG. 11 is a bottom view thereof;

FIG. 12 is a right side view thereof;

FIG. 13 is a left side view thereof;

FIG. 14 is a front view thereof; and

FIG. 15 is a rear view thereof;

FIG. 16 is a front, right and top perspective view of a second  
embodiment of a package shown with the lid or cover  
removed for ease of illustration;

FIG. 17 is a top view thereof;

FIG. 18 is a bottom view thereof;

(Continued)

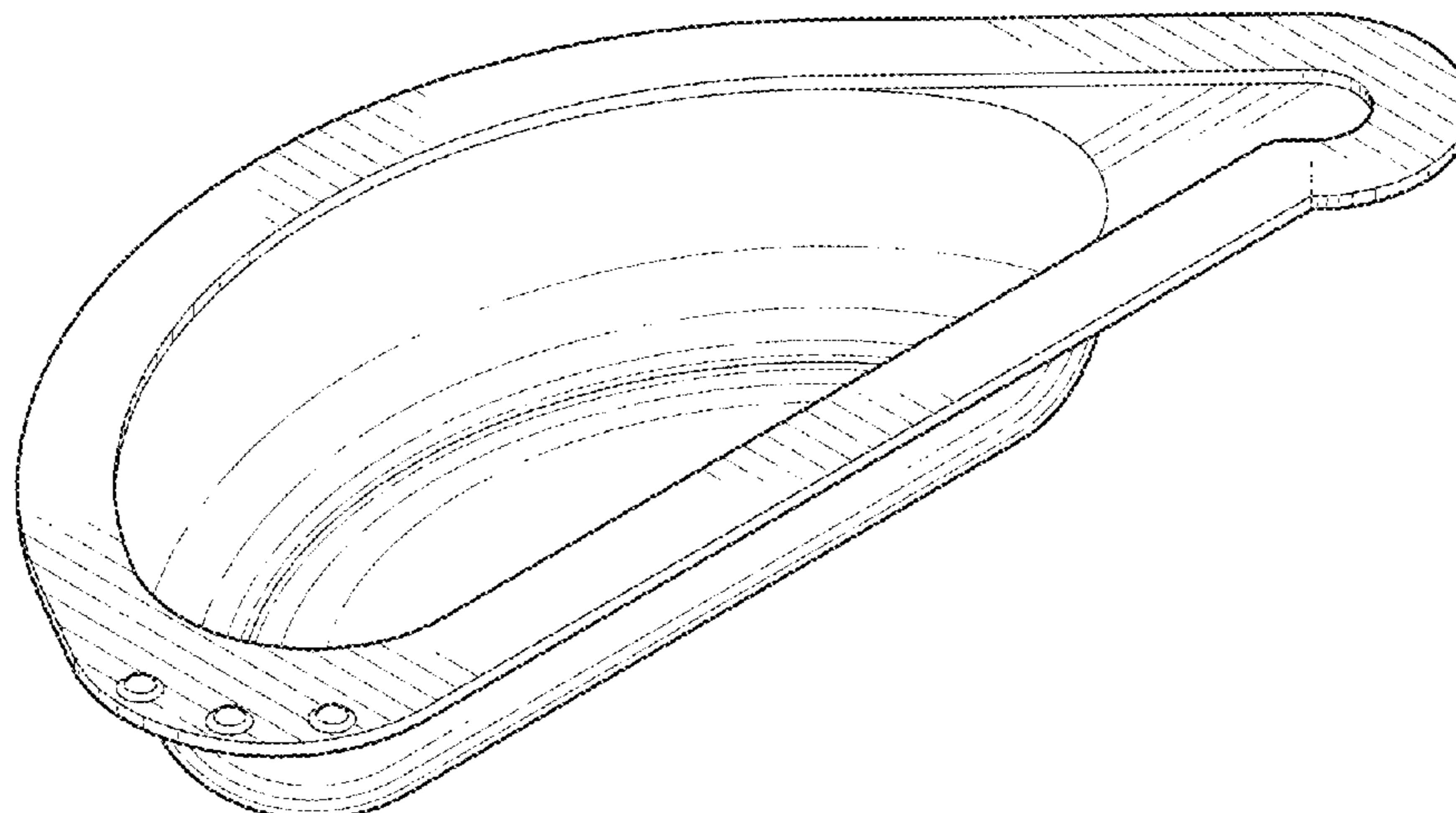

FIG. 19 is a right side view thereof;  
 FIG. 20 is a left side view thereof;  
 FIG. 21 is a front view thereof; and  
 FIG. 22 is a rear view thereof;  
 FIG. 23 is a front, right and top perspective view of the package shown in FIG. 16 with a lid or cover installed thereon;  
 FIG. 24 is a front, right and top perspective view thereof shown with a portion of the lid or cover being lifted off or raised at an angle at one end;  
 FIG. 25 is a top view thereof;  
 FIG. 26 is a bottom view thereof;  
 FIG. 27 is a right side view thereof;  
 FIG. 28 is a left side view thereof;  
 FIG. 29 is a front view thereof; and  
 FIG. 30 is a rear view thereof;  
 FIG. 31 is a front, right and top perspective view of a third embodiment of a package shown with the lid or cover removed for ease of illustration;  
 FIG. 32 is a top view thereof;  
 FIG. 33 is a bottom view thereof;  
 FIG. 34 is a right side view thereof;  
 FIG. 35 is a left side view thereof;  
 FIG. 36 is a front view thereof; and  
 FIG. 37 is a rear view thereof;  
 FIG. 38 is a front, right and top perspective view of the package shown in FIG. 31 with a lid or cover installed thereon;  
 FIG. 39 is a front, right and top perspective view thereof shown with a portion of the lid or cover being lifted off or raised at an angle at one end;  
 FIG. 40 is a top view thereof;  
 FIG. 41 is a bottom view thereof;  
 FIG. 42 is a right side view thereof;  
 FIG. 43 is a left side view thereof;  
 FIG. 44 is a front view thereof; and,  
 FIG. 45 is a rear view thereof.  
 The short broken line in each of FIGS. 1-3 and 8-11 depicts a weakened line in the material and forms no part of the claimed design.  
 The remaining broken lines depict portions of the package that form no part of the claimed design.

**1 Claim, 24 Drawing Sheets**

**(58) Field of Classification Search**

CPC .. B65D 75/327; B65D 75/48; B65D 75/5811;  
 B65D 75/5855; B65D 2575/3245  
 See application file for complete search history.

**(56) References Cited**

U.S. PATENT DOCUMENTS

D351,992 S \* 11/1994 Jacques ..... D9/696  
 D435,440 S \* 12/2000 Croft ..... D9/696  
 D442,078 S \* 5/2001 Fuquen ..... D9/696  
 D445,673 S \* 7/2001 Richardson ..... D9/710  
 D445,674 S \* 7/2001 Pritchett ..... D9/707

D448,661 S \* 10/2001 Kerr ..... D9/696  
 D520,185 S \* 5/2006 Zeng ..... D28/8.1  
 D594,752 S \* 6/2009 Medema ..... D9/707  
 7,703,619 B2 4/2010 Van Puijenbroek  
 D619,018 S \* 7/2010 Karay ..... D9/702  
 D620,809 S \* 8/2010 Caldwell ..... D9/707  
 D621,719 S 8/2010 Caldwell et al.  
 D632,565 S 2/2011 Caldwell et al.  
 D632,569 S 2/2011 Caldwell et al.  
 D634,643 S 3/2011 Caldwell et al.  
 8,110,233 B2 2/2012 Beavers Blanks et al.  
 D655,201 S \* 3/2012 Schuch ..... D9/707  
 D663,631 S 7/2012 McDermott et al.  
 8,231,026 B2 7/2012 White  
 8,328,043 B2 12/2012 Kessell et al.  
 D674,707 S \* 1/2013 Berman ..... D9/710  
 8,403,161 B2 3/2013 Van Puijenbroek  
 D699,127 S 2/2014 Garrity et al.  
 D703,063 S 4/2014 Garrity et al.  
 8,919,594 B2 12/2014 Teys  
 8,950,635 B2 2/2015 Loya  
 9,061,796 B2 6/2015 Caldwell et al.  
 9,073,681 B2 7/2015 Huels et al.  
 D735,584 S \* 8/2015 Berlepsch ..... D9/710  
 D737,691 S 9/2015 Abbott et al.  
 D739,261 S 9/2015 Sutherland  
 D742,216 S 11/2015 Abbott et al.  
 D744,352 S \* 12/2015 Quarles ..... D9/707  
 9,199,584 B2 12/2015 Mango  
 9,260,231 B2 2/2016 Havrileck et al.  
 9,296,324 B2 3/2016 Mango  
 9,399,542 B1 7/2016 Davison  
 D783,411 S 4/2017 Sutherland  
 9,764,863 B2 9/2017 Huels et al.  
 D799,336 S \* 10/2017 Sahatjian ..... D9/696  
 9,856,051 B2 1/2018 Caminada  
 D818,819 S \* 5/2018 Buck ..... D9/416  
 D823,105 S \* 7/2018 Wardius, Jr. .... D9/425  
 D824,248 S \* 7/2018 Tuchrelo ..... D9/425  
 10,017,300 B2 7/2018 McGuire et al.  
 D826,728 S \* 8/2018 Sahatjian ..... D9/696  
 10,080,417 B2 9/2018 Wallwork  
 D833,300 S 11/2018 Sahatjian  
 D856,821 S \* 8/2019 Sahatjian ..... D9/708  
 10,507,970 B2 12/2019 Wetton et al.  
 D909,886 S \* 2/2021 Sahatjian ..... D9/710  
 D912,528 S \* 3/2021 Sahatjian ..... D9/710  
 D920,094 S \* 5/2021 Purkey ..... D9/416  
 D923,469 S \* 6/2021 Althaus ..... D9/425  
 D930,467 S \* 9/2021 Althaus ..... D9/425  
 D931,097 S \* 9/2021 Lu ..... D9/425  
 D934,066 S \* 10/2021 Purkey ..... D9/416  
 2007/0164045 A1 7/2007 Wydler et al.  
 2010/0213197 A1 8/2010 Stuart  
 2011/0079594 A1 4/2011 White  
 2011/0309096 A1 12/2011 Jones  
 2012/0223099 A1 9/2012 Sanchez  
 2013/0292414 A1 11/2013 Sutherland

OTHER PUBLICATIONS

Design U.S. Appl. No. 29/752,031, Okoroafor et al., "Squeeze and Dip Package," filed Sep. 24, 2020.  
 Design U.S. Appl. No. 29/752,034, Okoroafor et al., "Squeeze and Dip Package," filed Sep. 24, 2020.  
 Design U.S. Appl. No. 29/752,037, Okoroafor et al., "Squeeze and Dip Package," filed Sep. 24, 2020.

\* cited by examiner



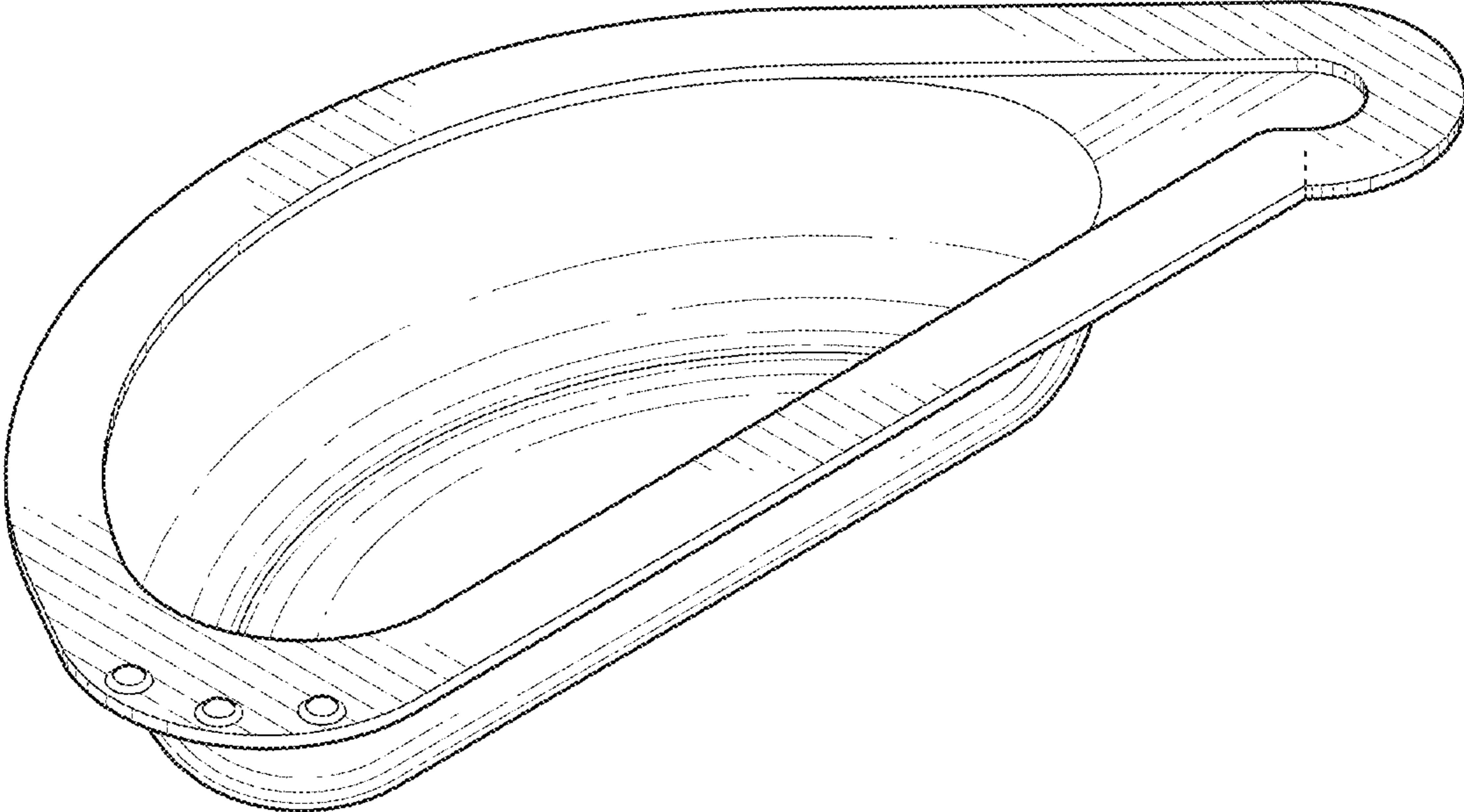

FIG. 1

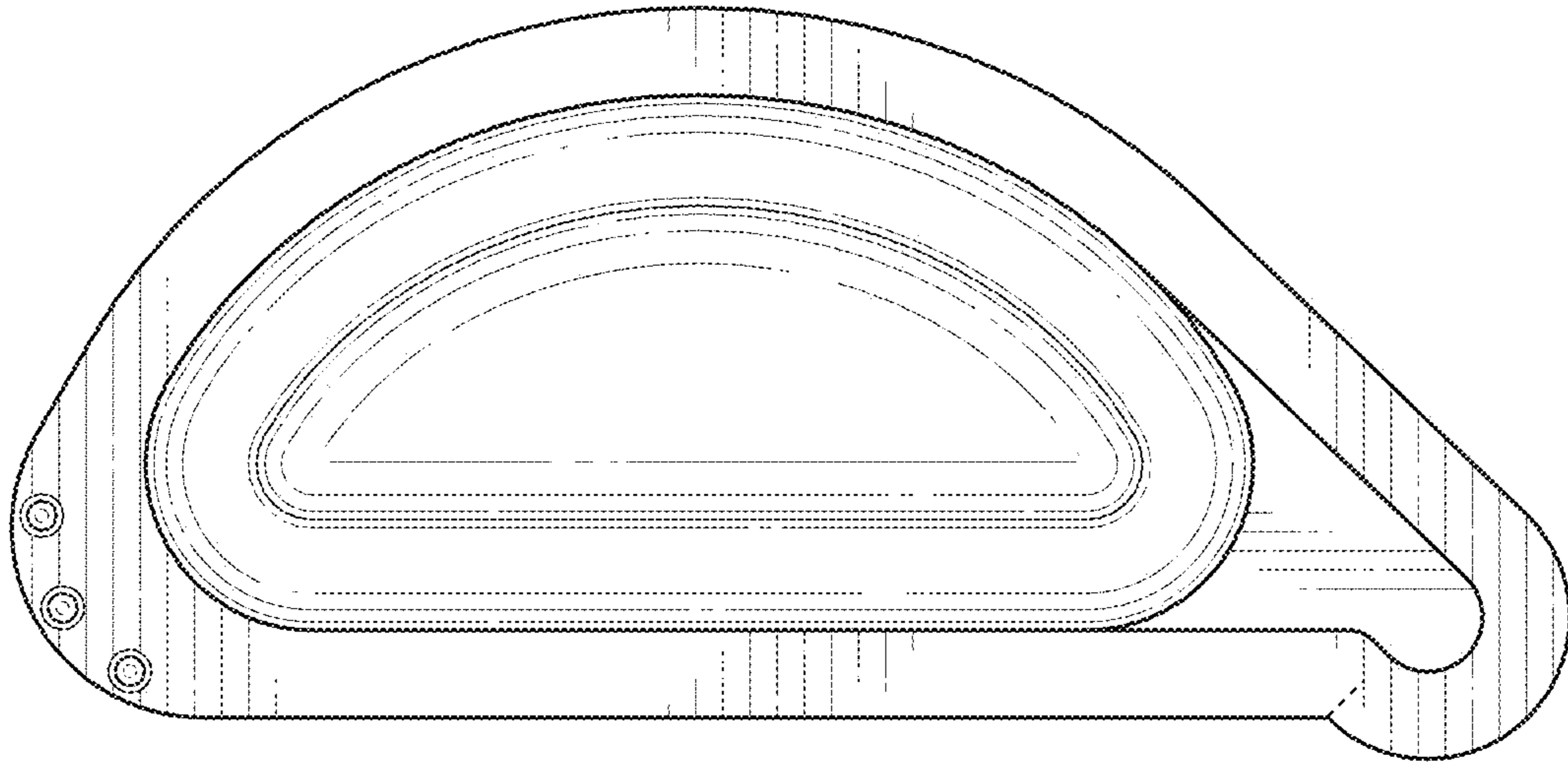

FIG. 2

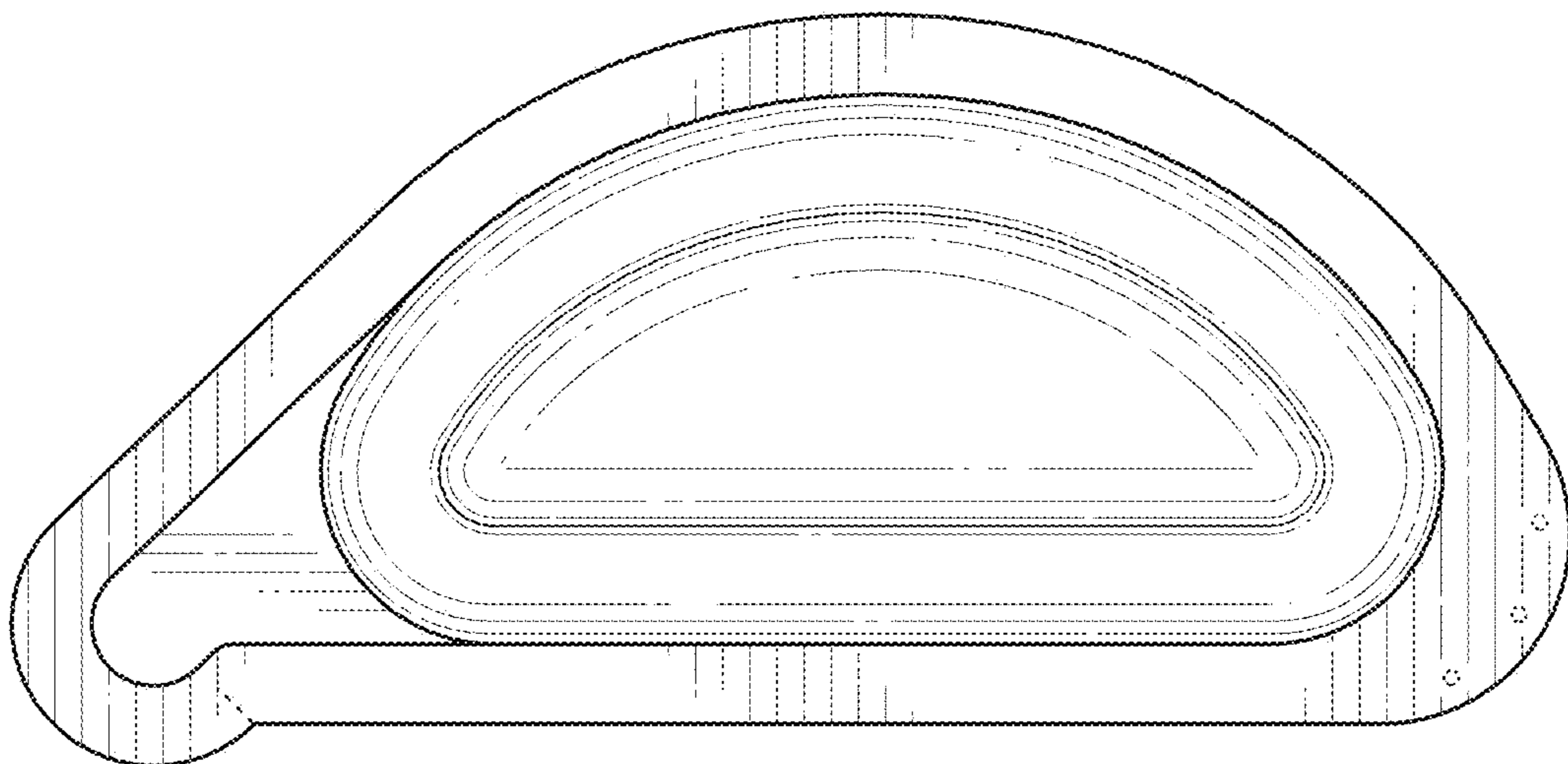
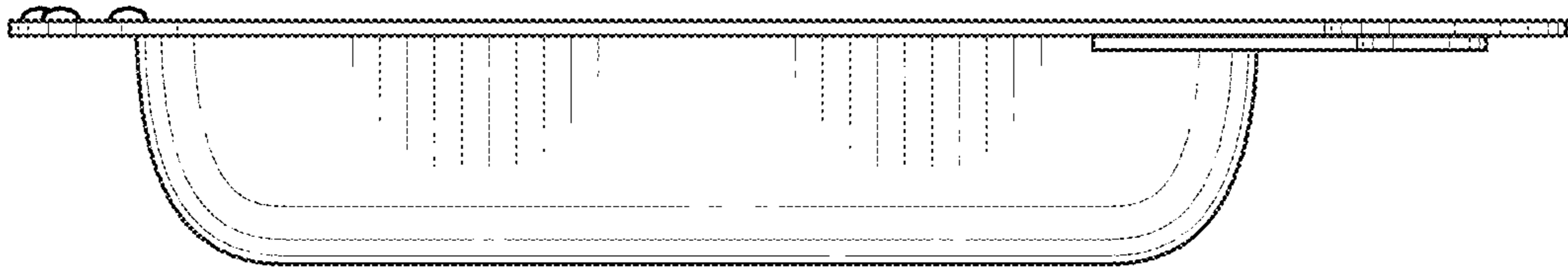
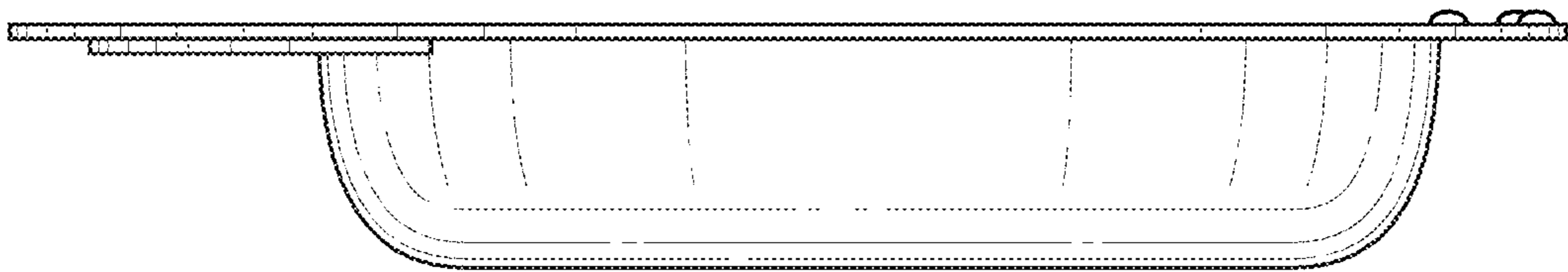

FIG. 3



**FIG. 4**



**FIG. 5**

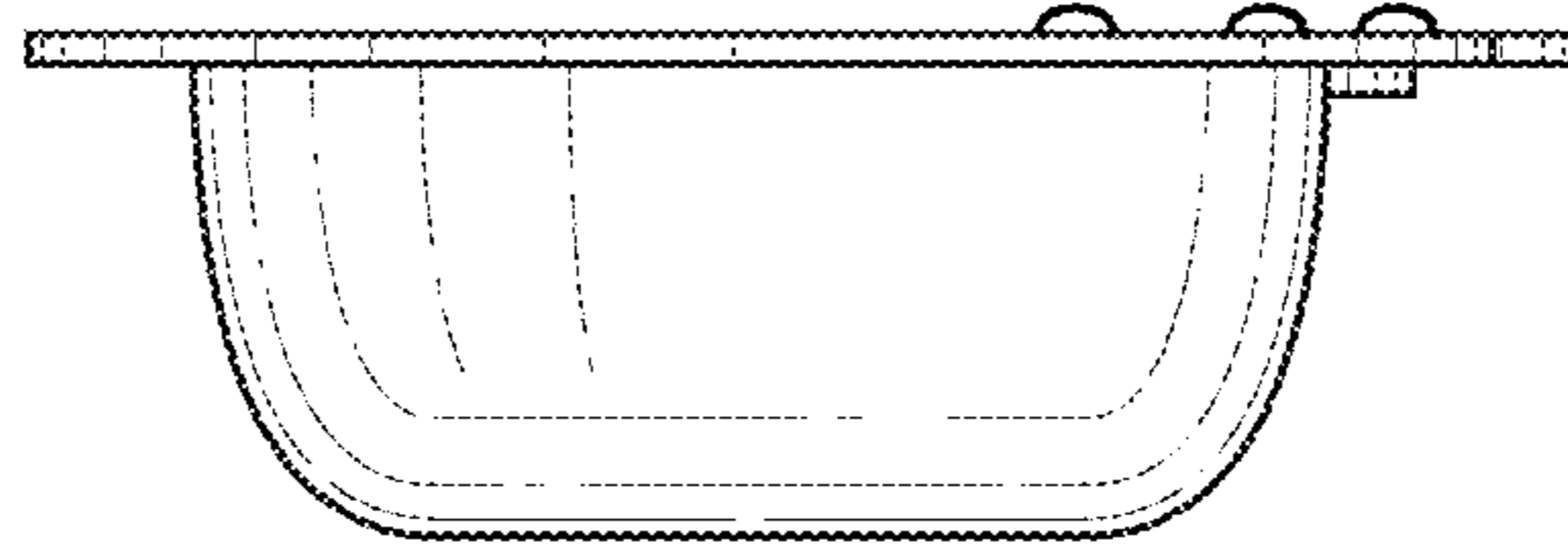

**FIG. 6**

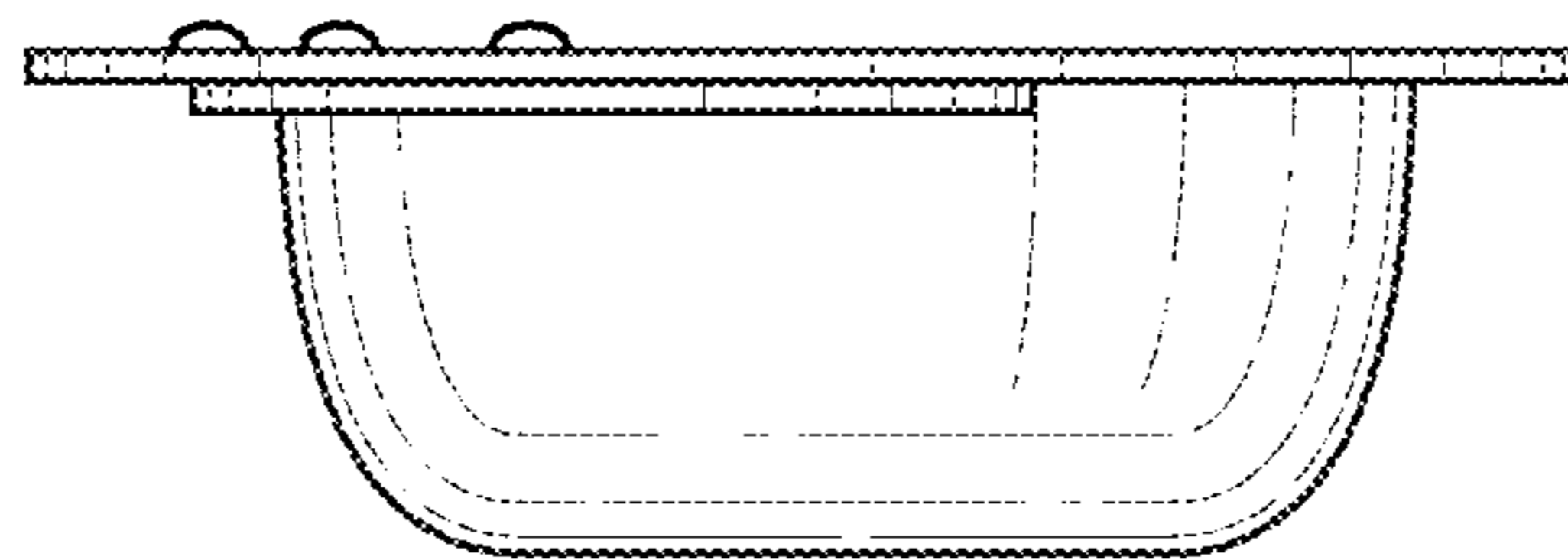

**FIG. 7**

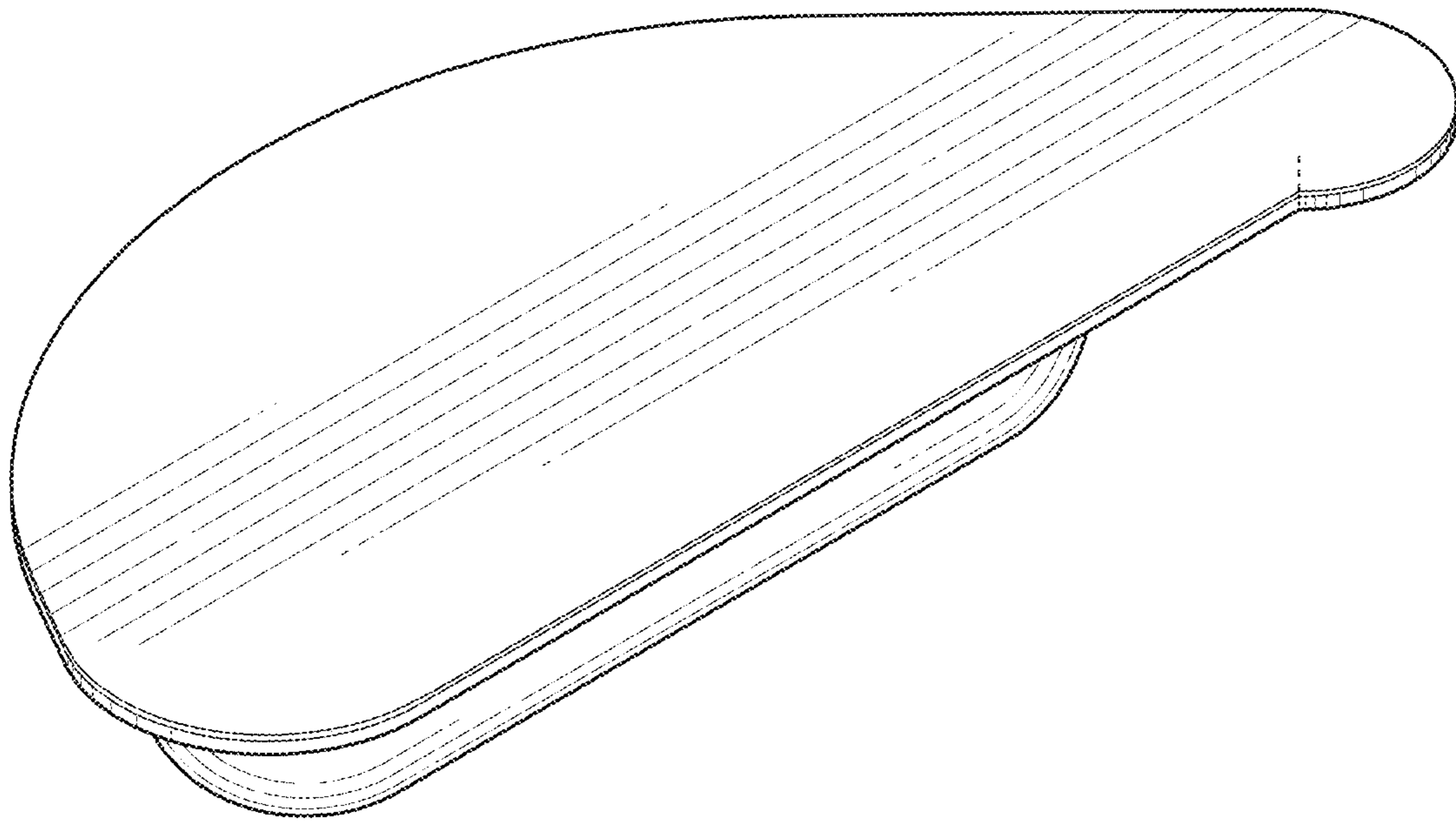

FIG. 8

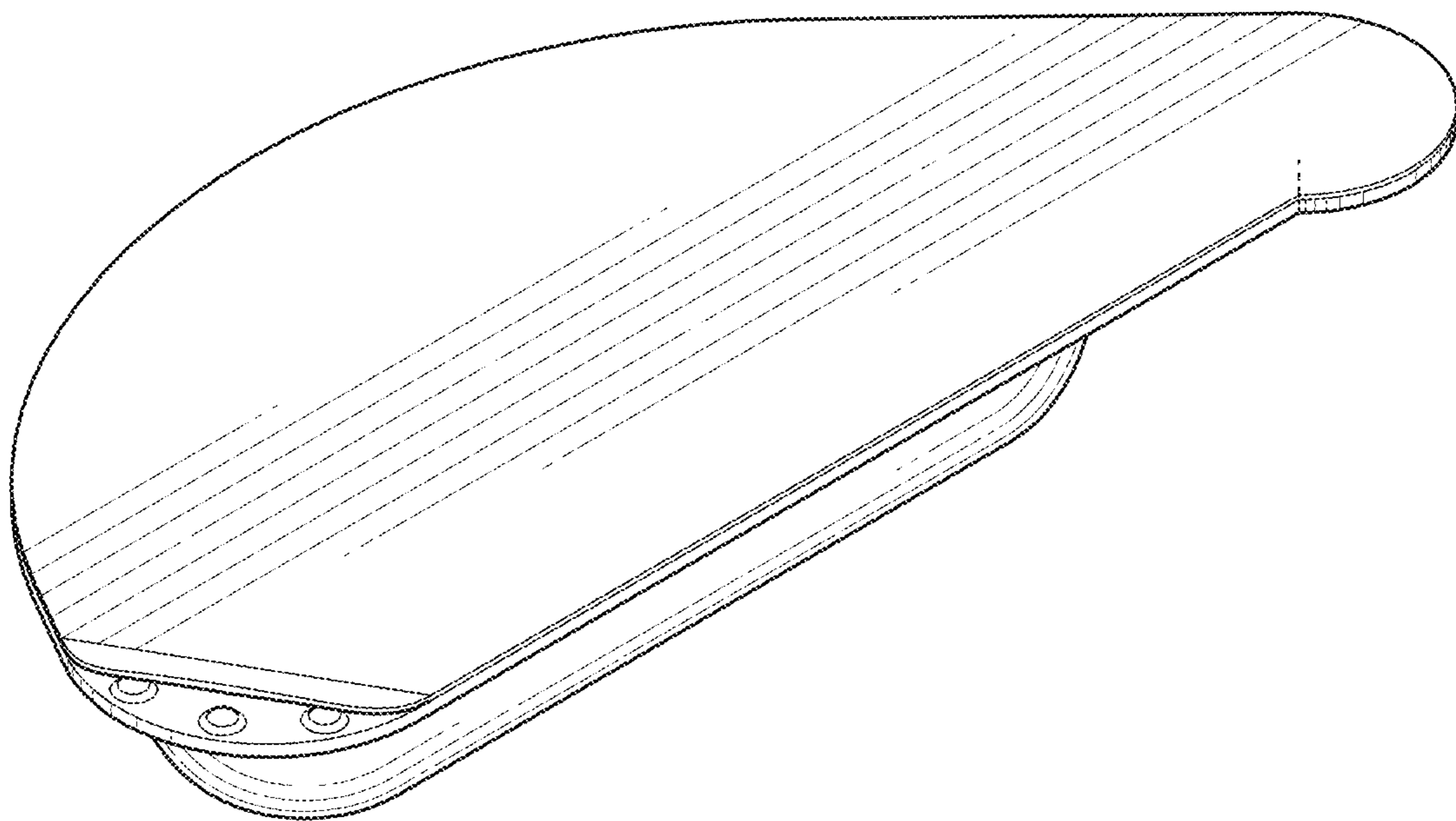
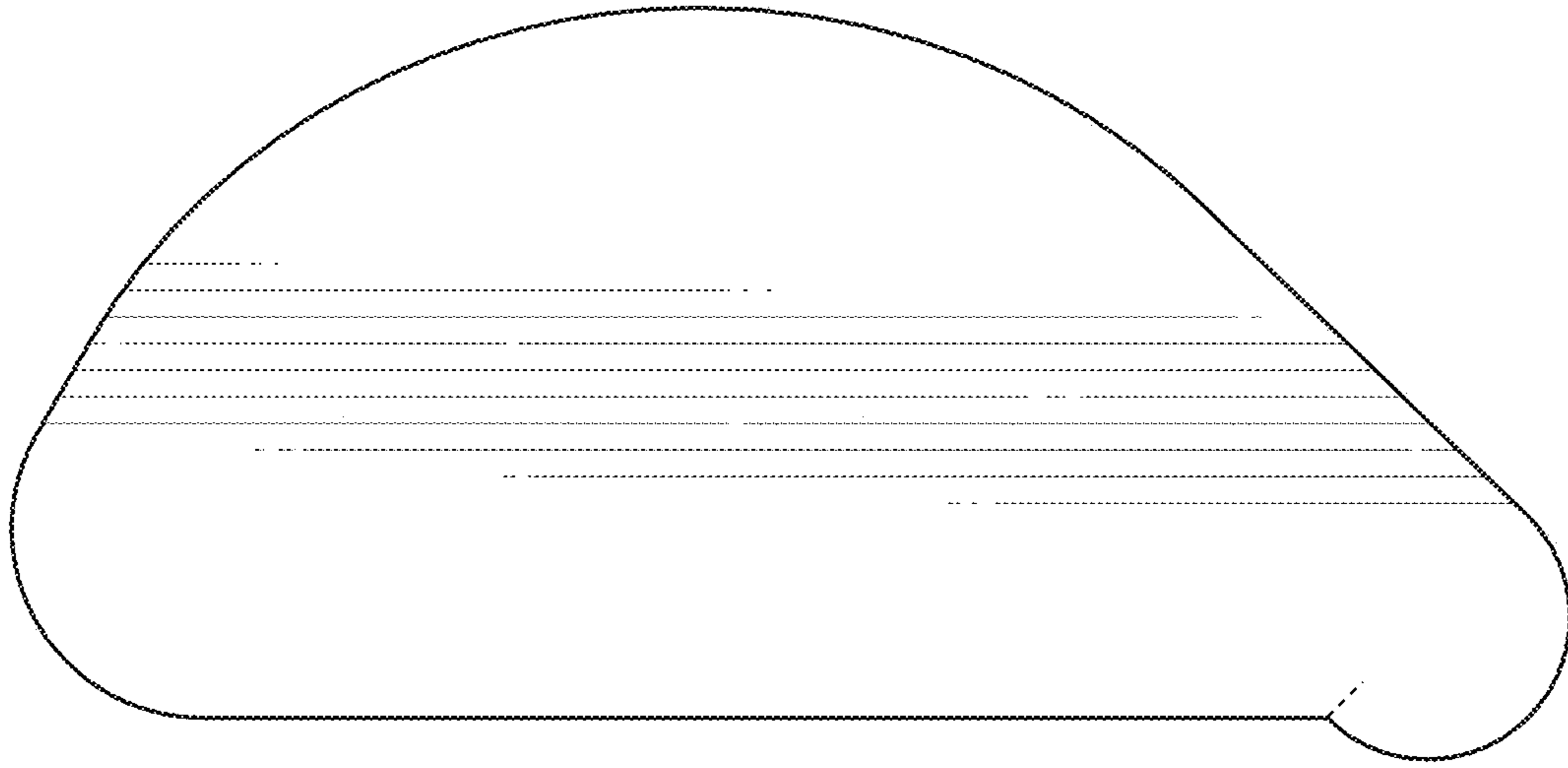
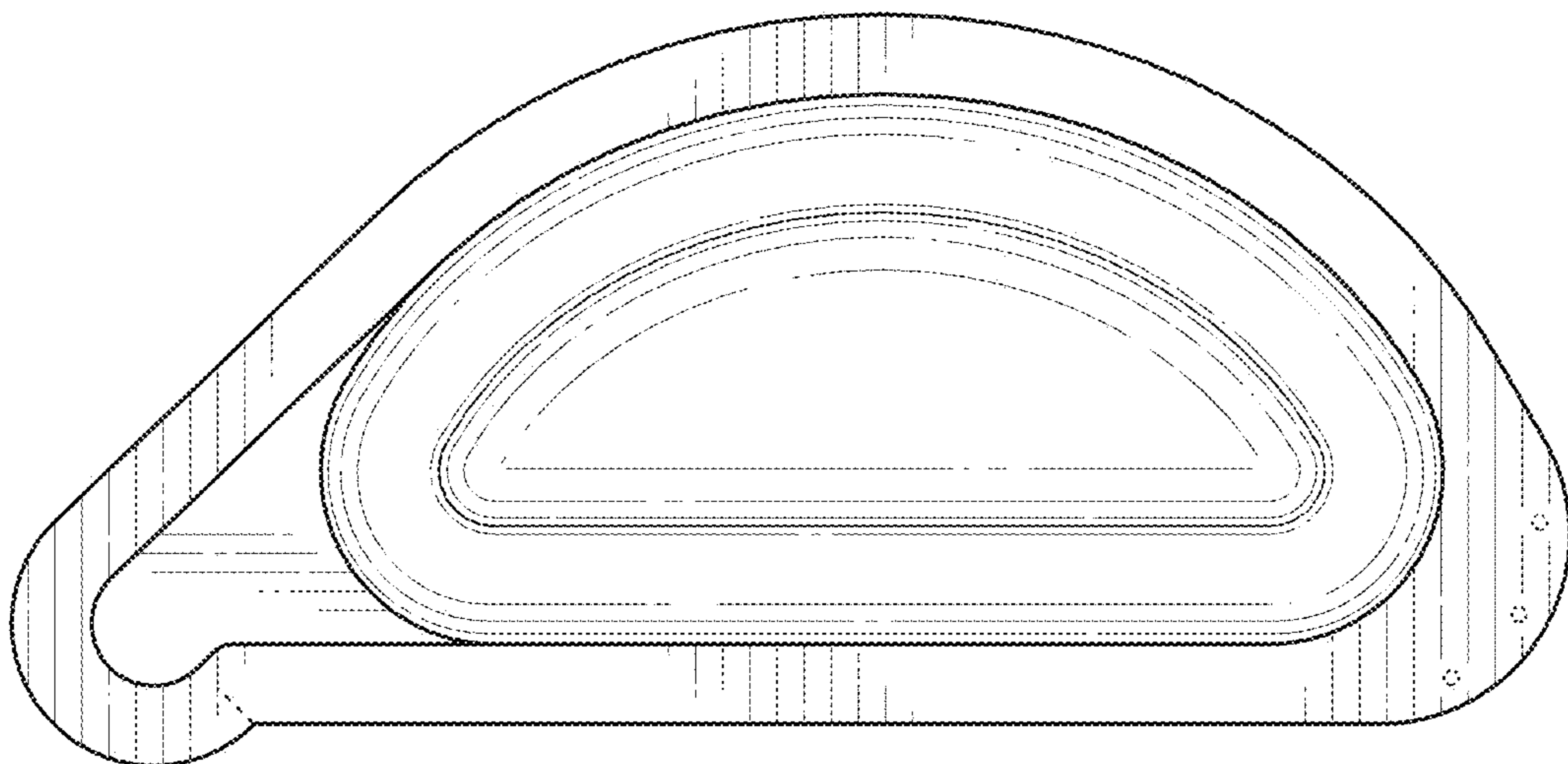

FIG. 9

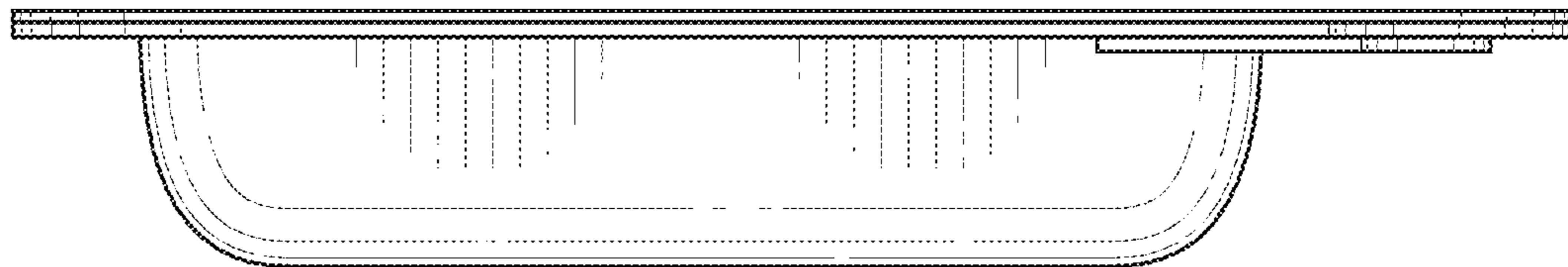

**FIG. 10**

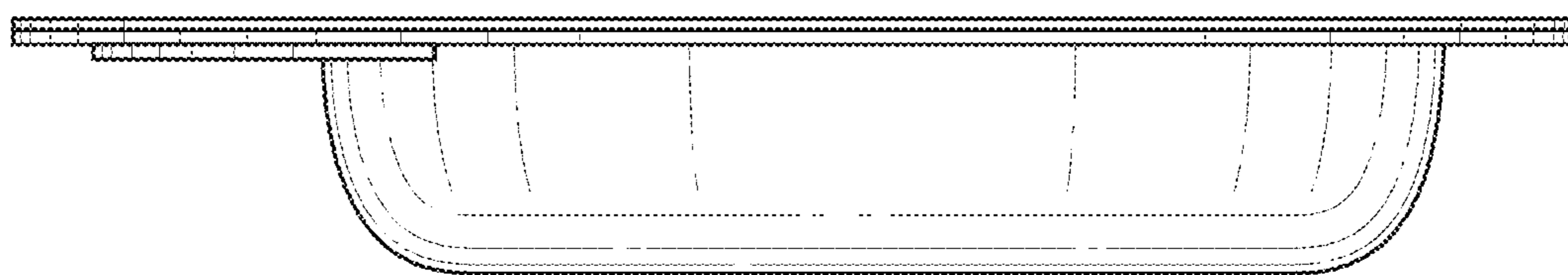

**FIG. 11**





**FIG. 12**



**FIG. 13**

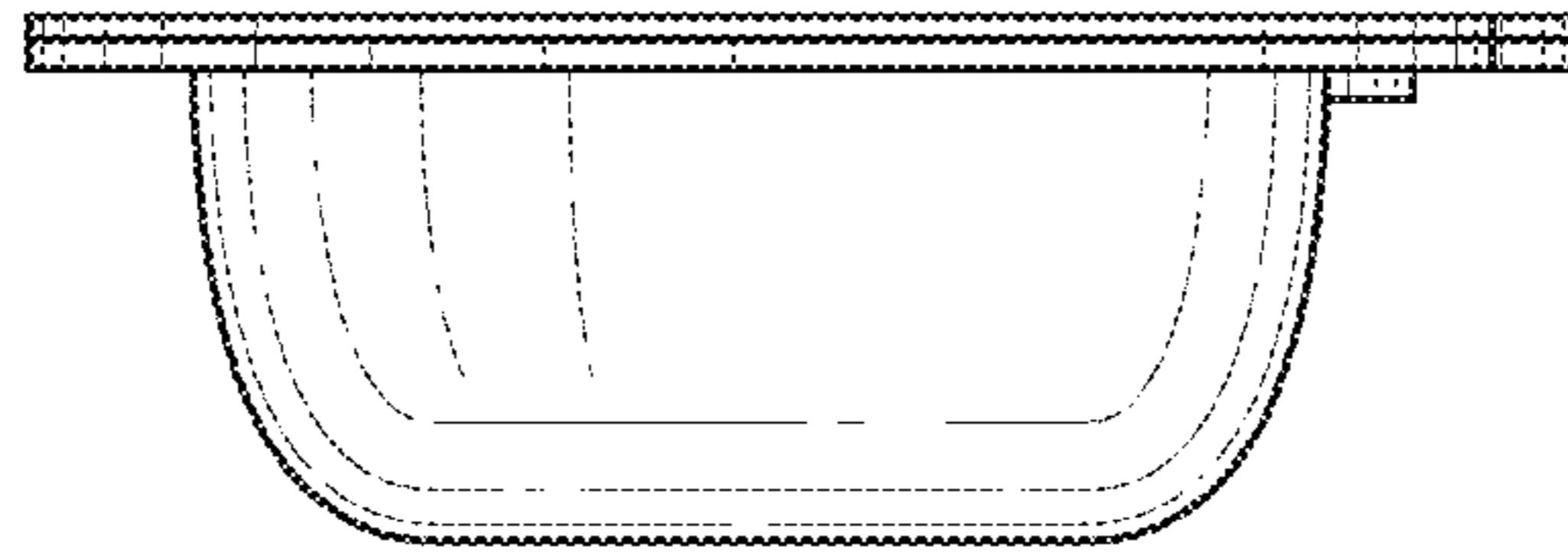

FIG. 14

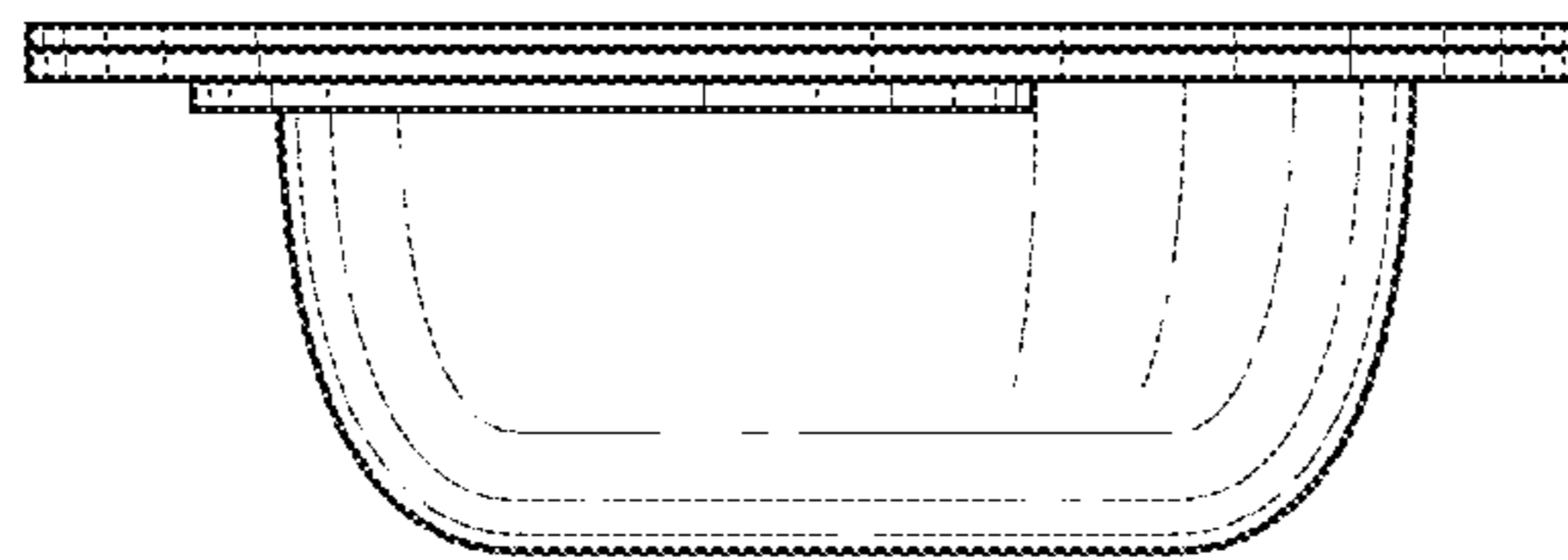
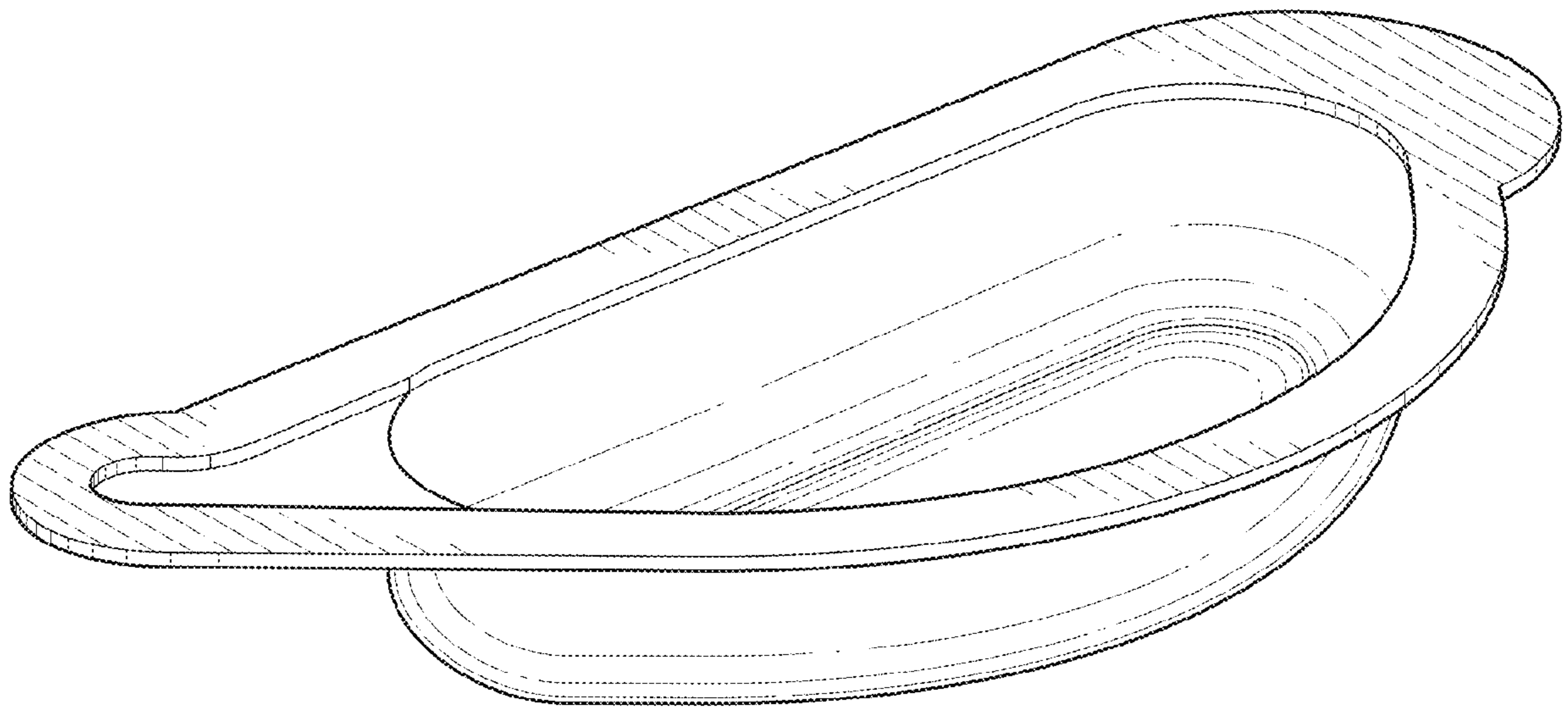
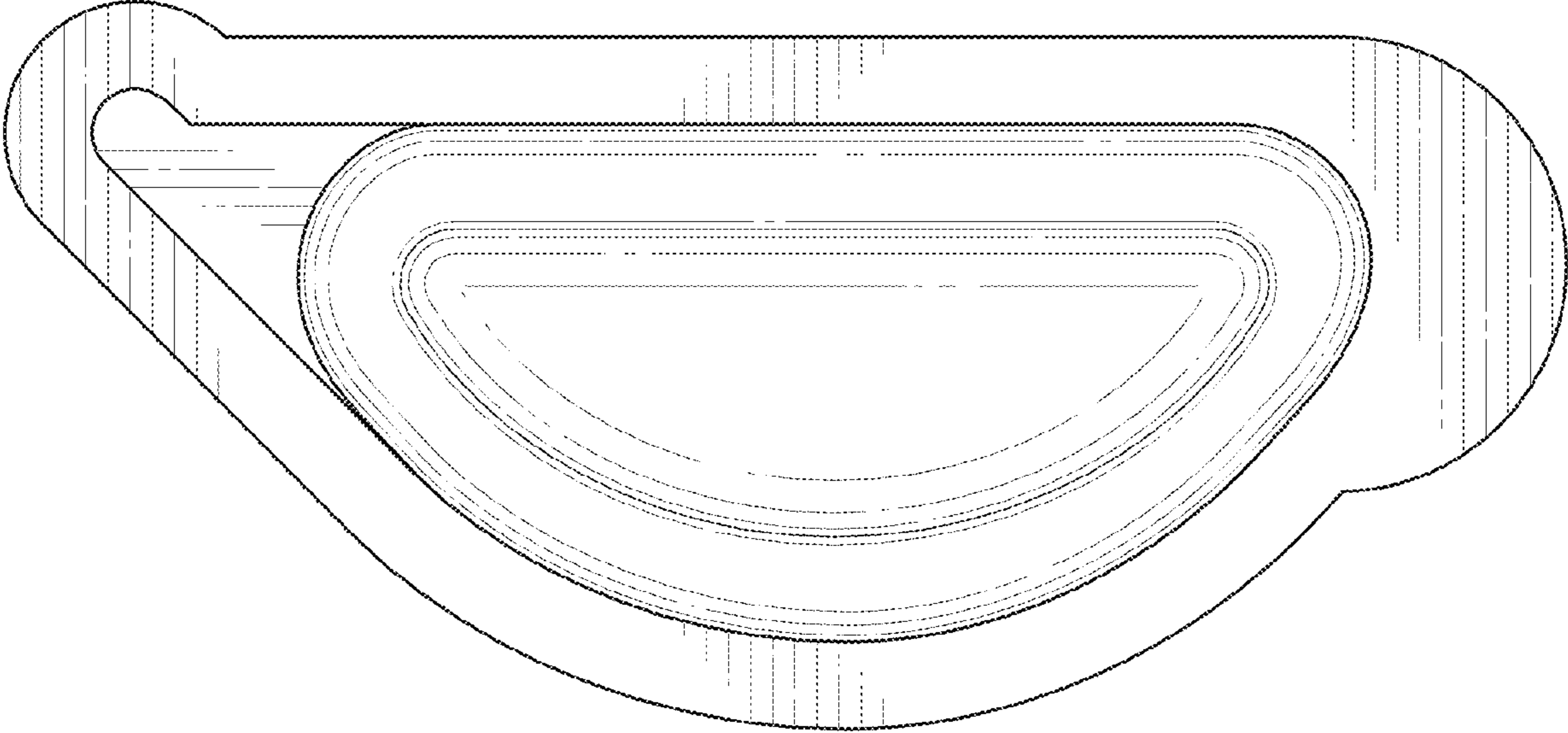

FIG. 15



**FIG. 16**



**FIG. 17**

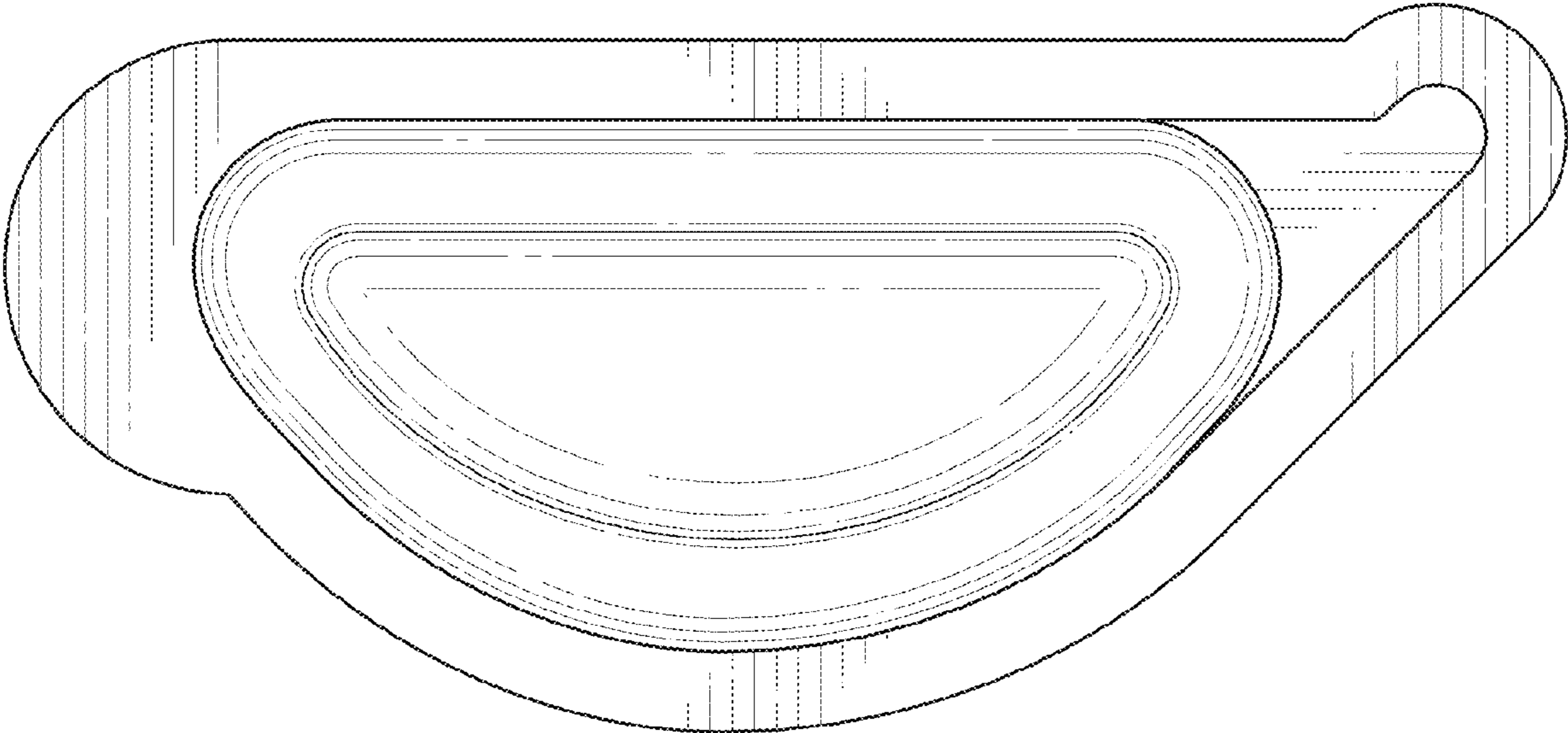

**FIG. 18**



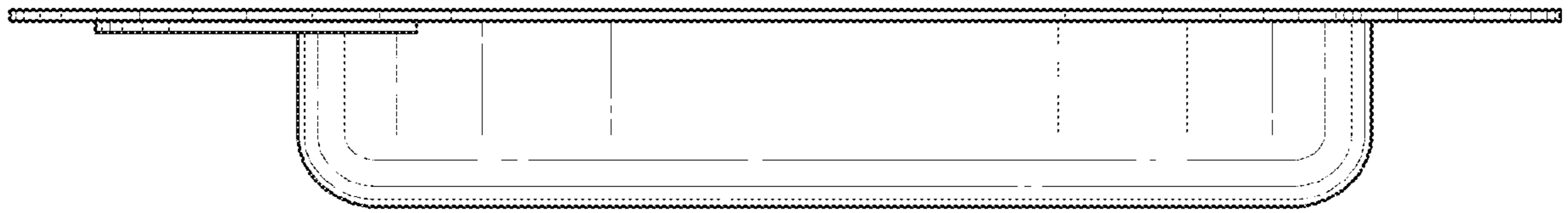

FIG. 19

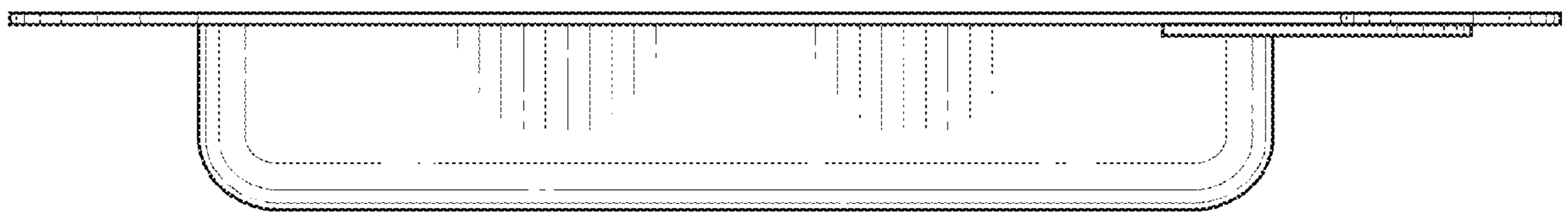

FIG. 20

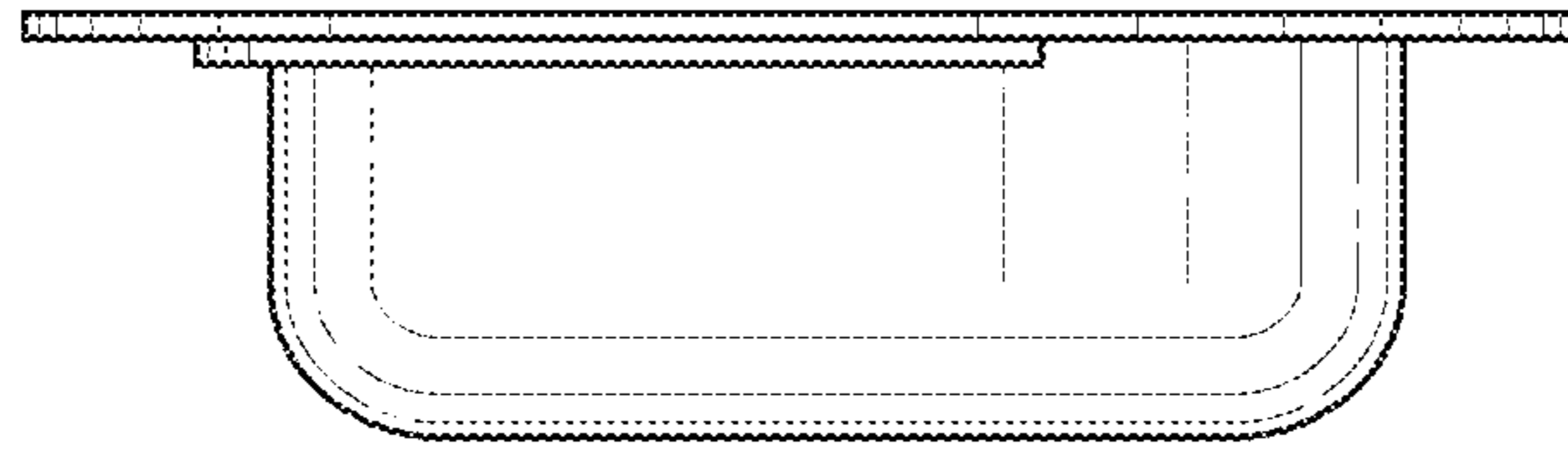

FIG. 21

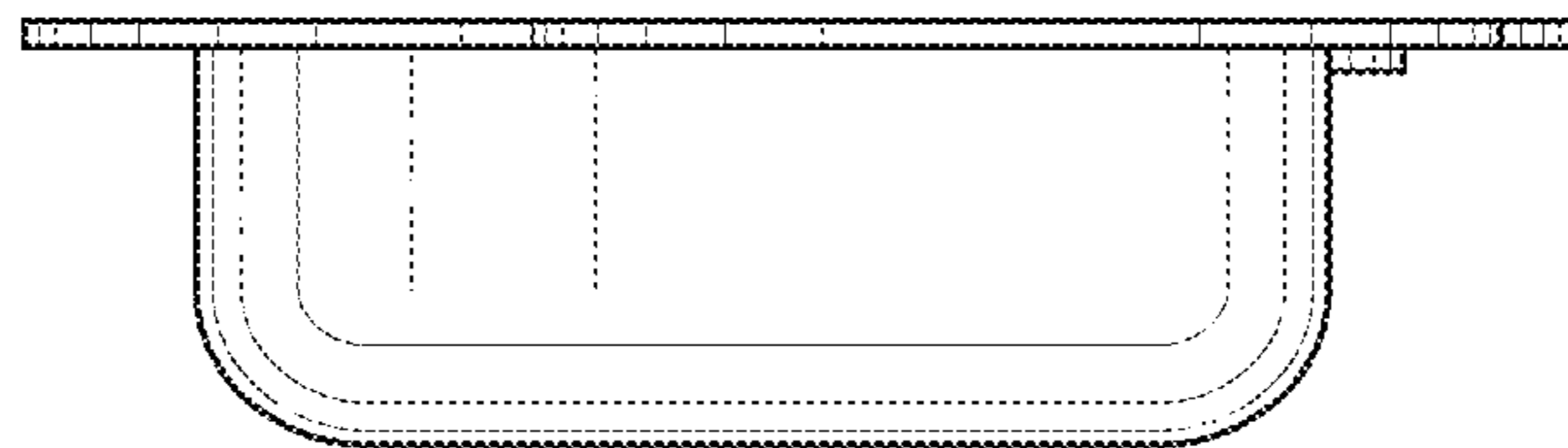
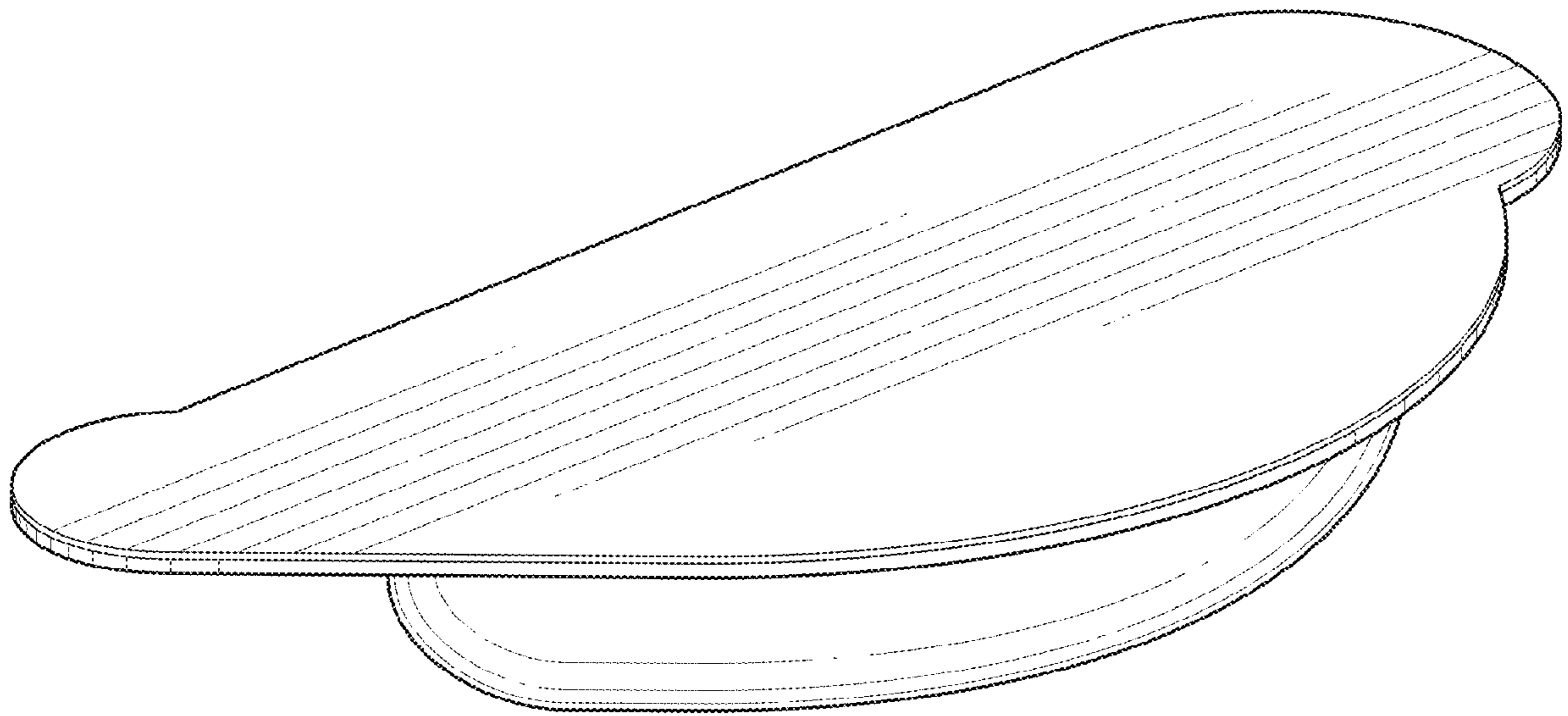
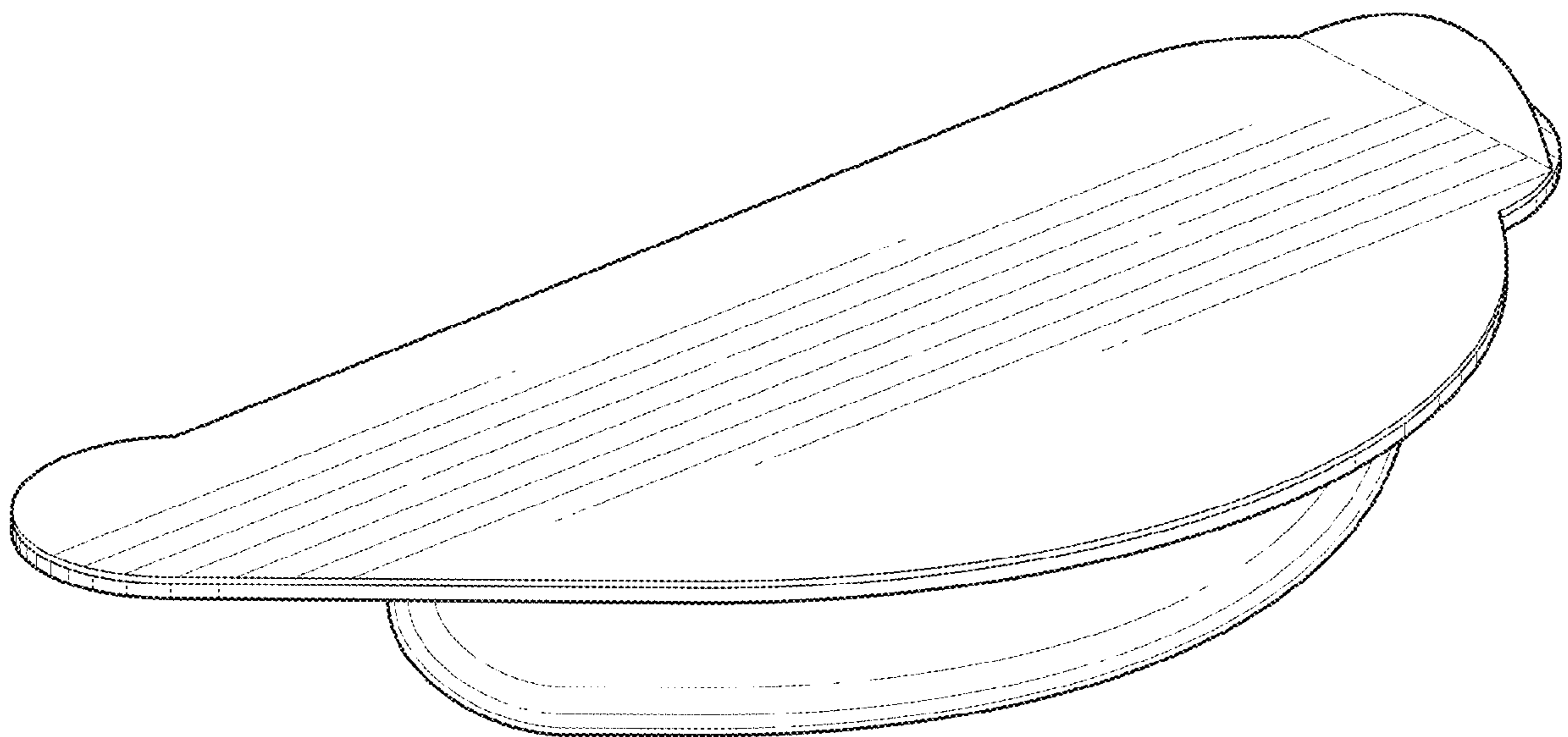

FIG. 22



**FIG. 23**



**FIG. 24**

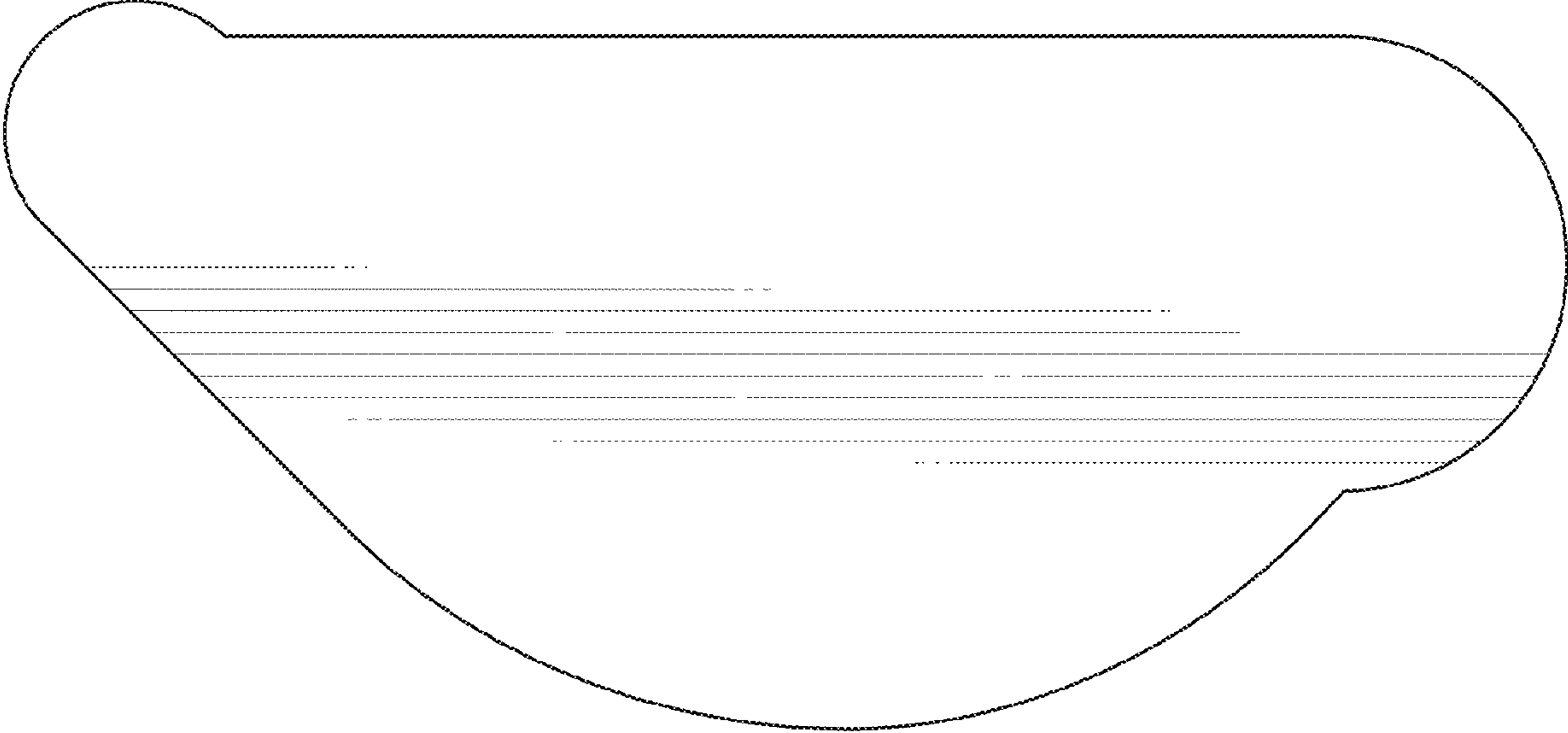

FIG. 25

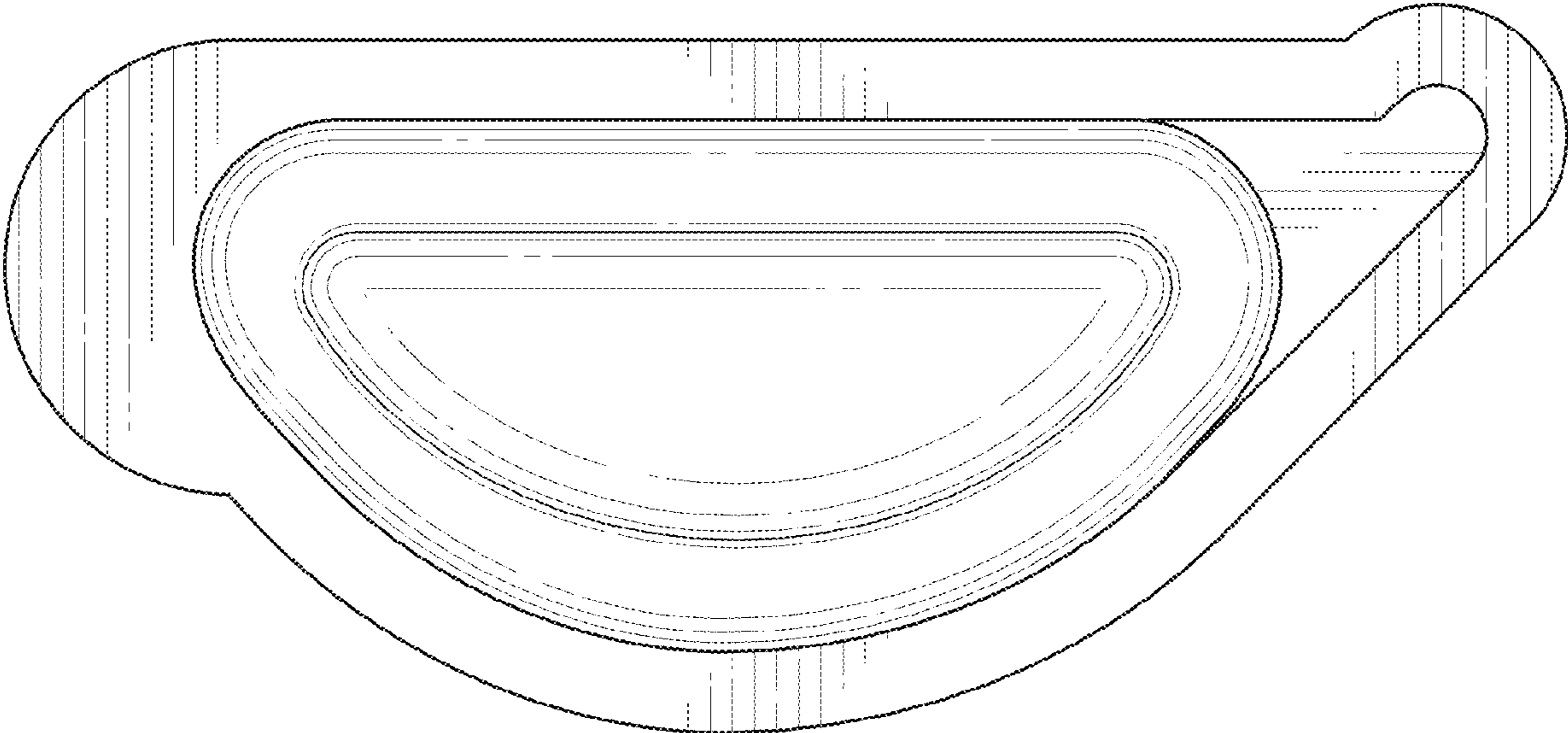

FIG. 26



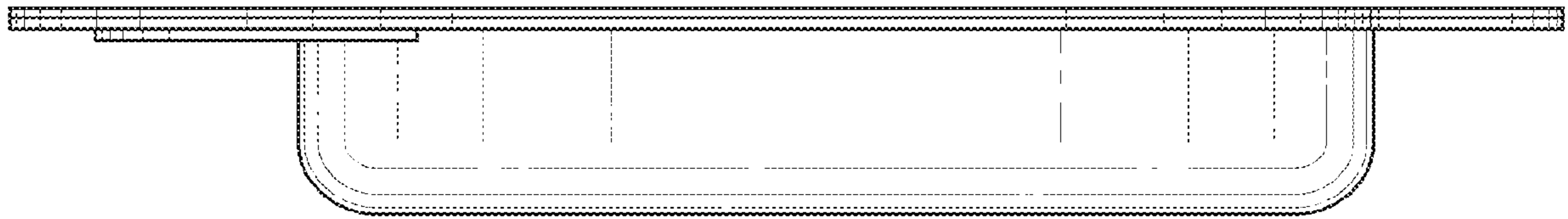

FIG. 27

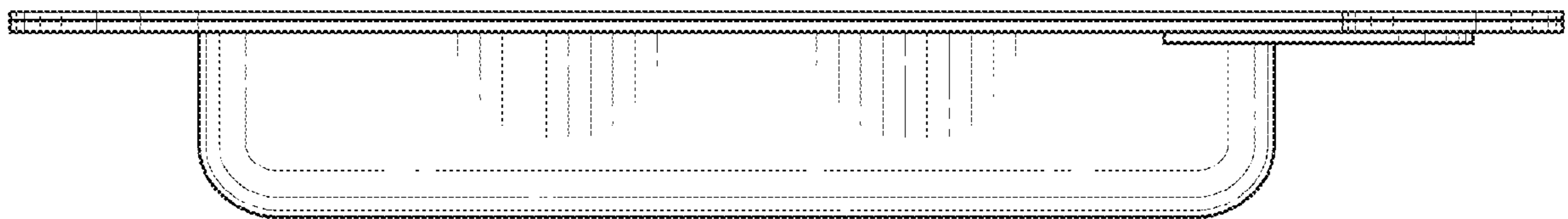

FIG. 28

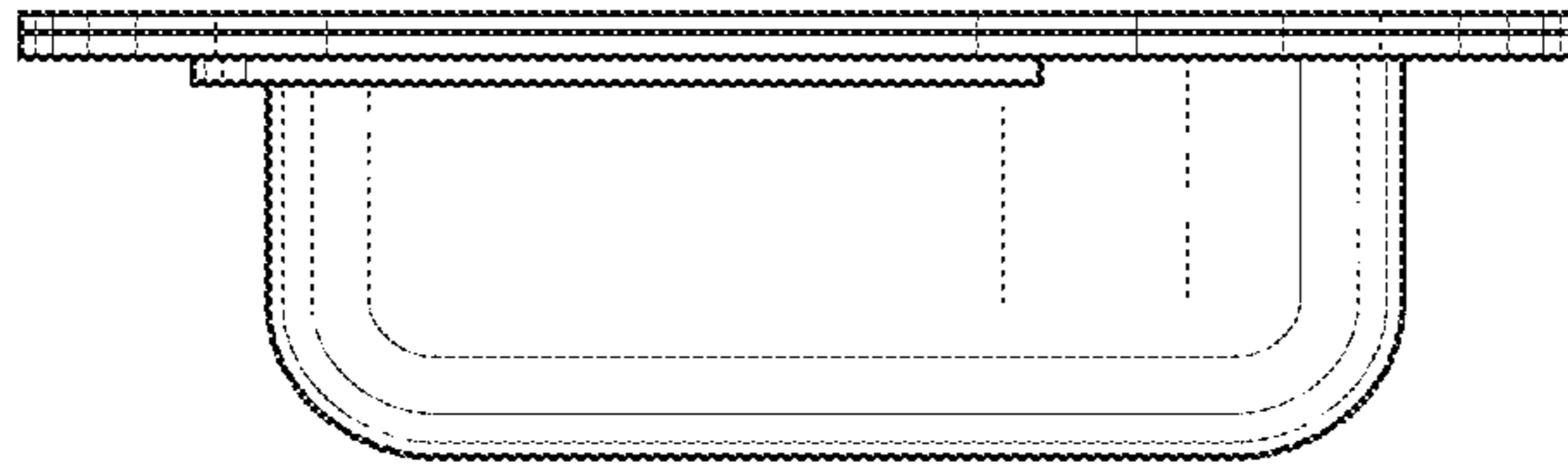

FIG. 29

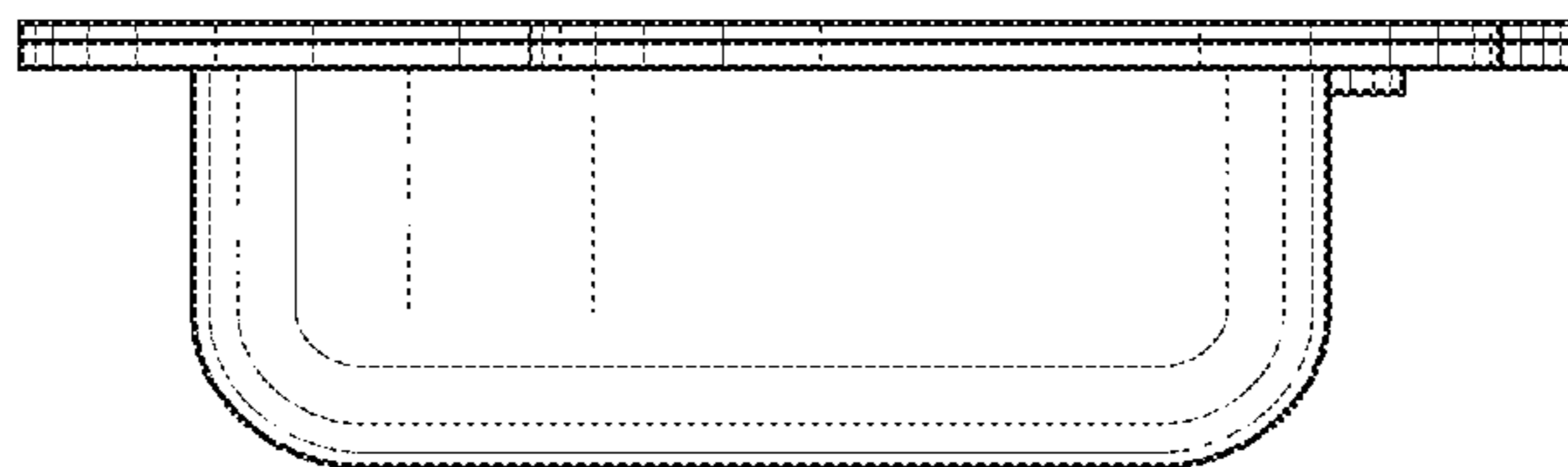

FIG. 30

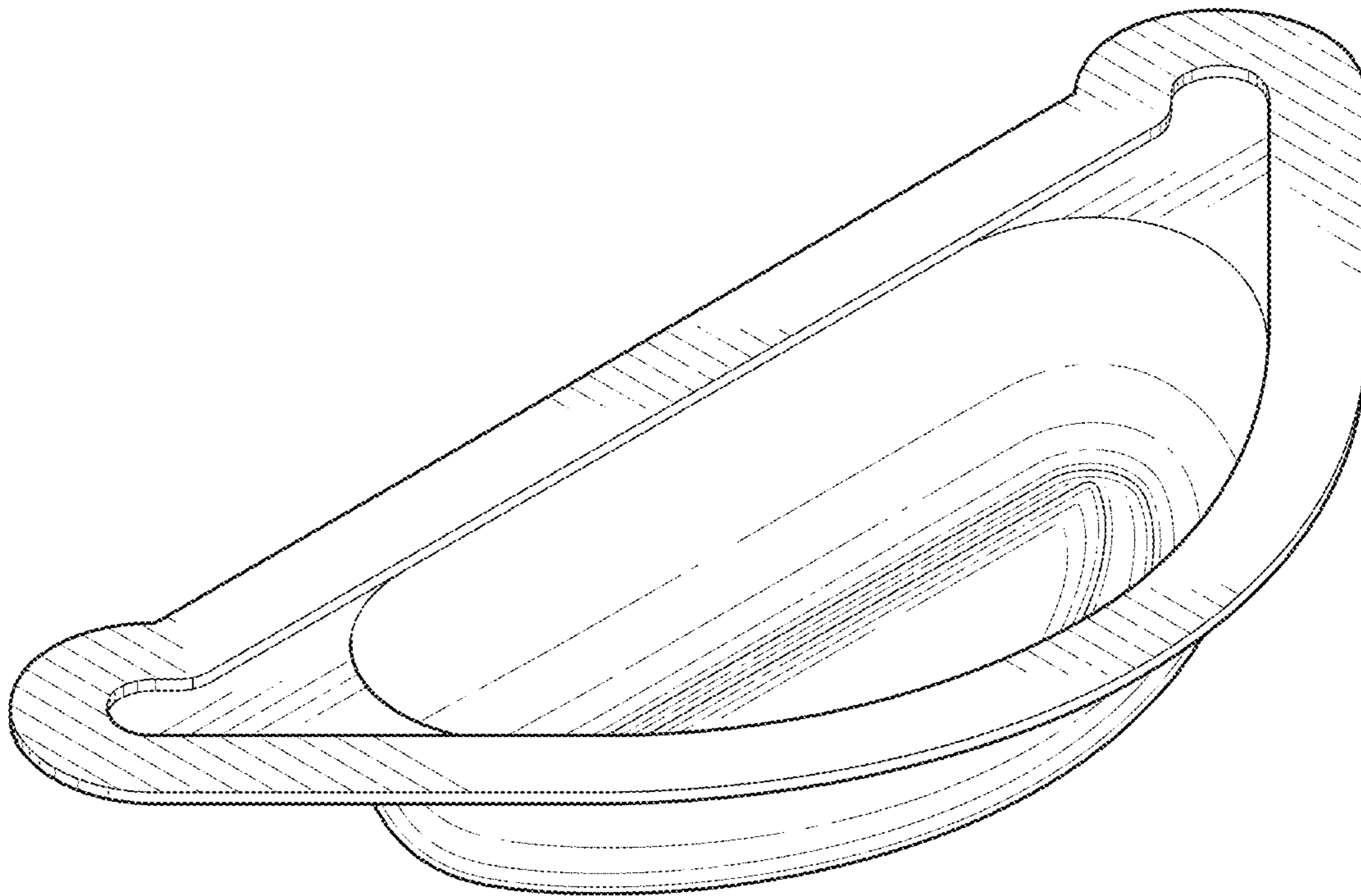
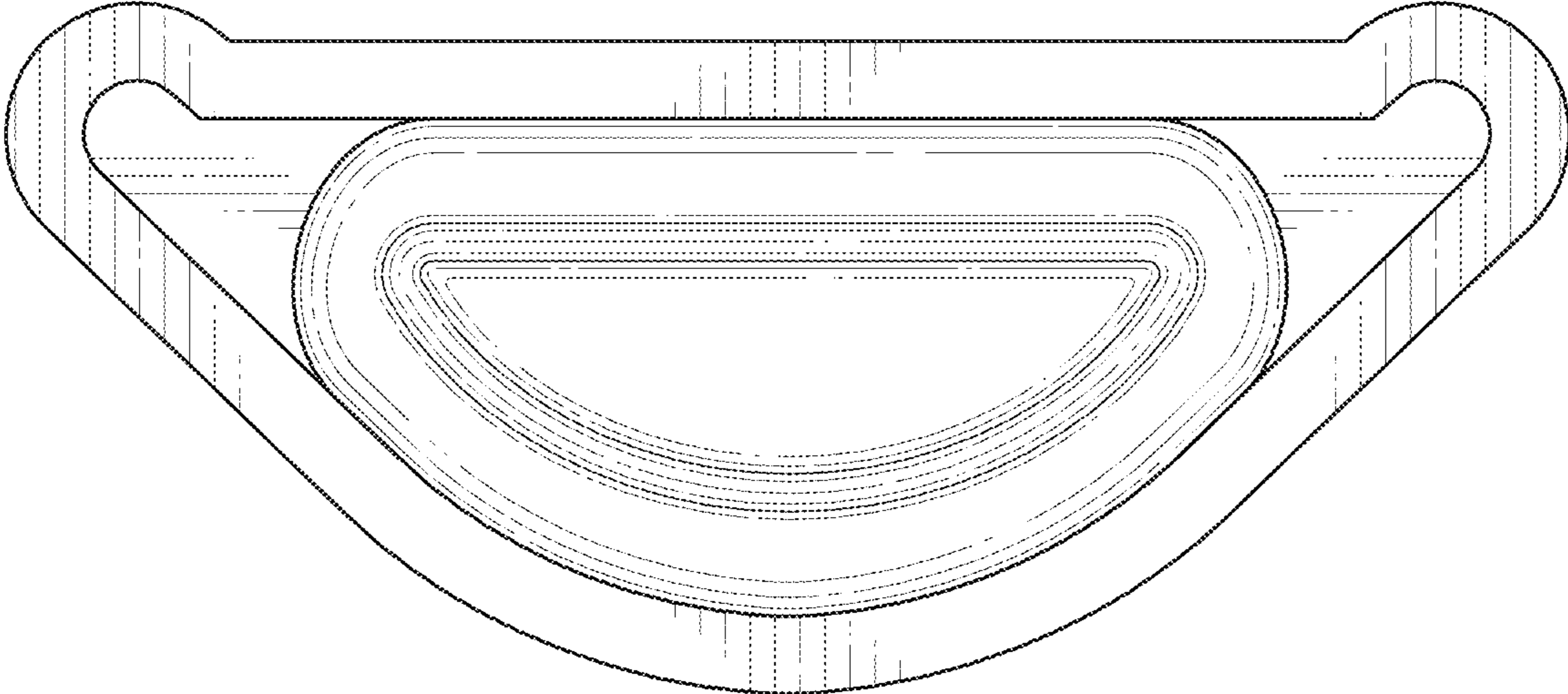
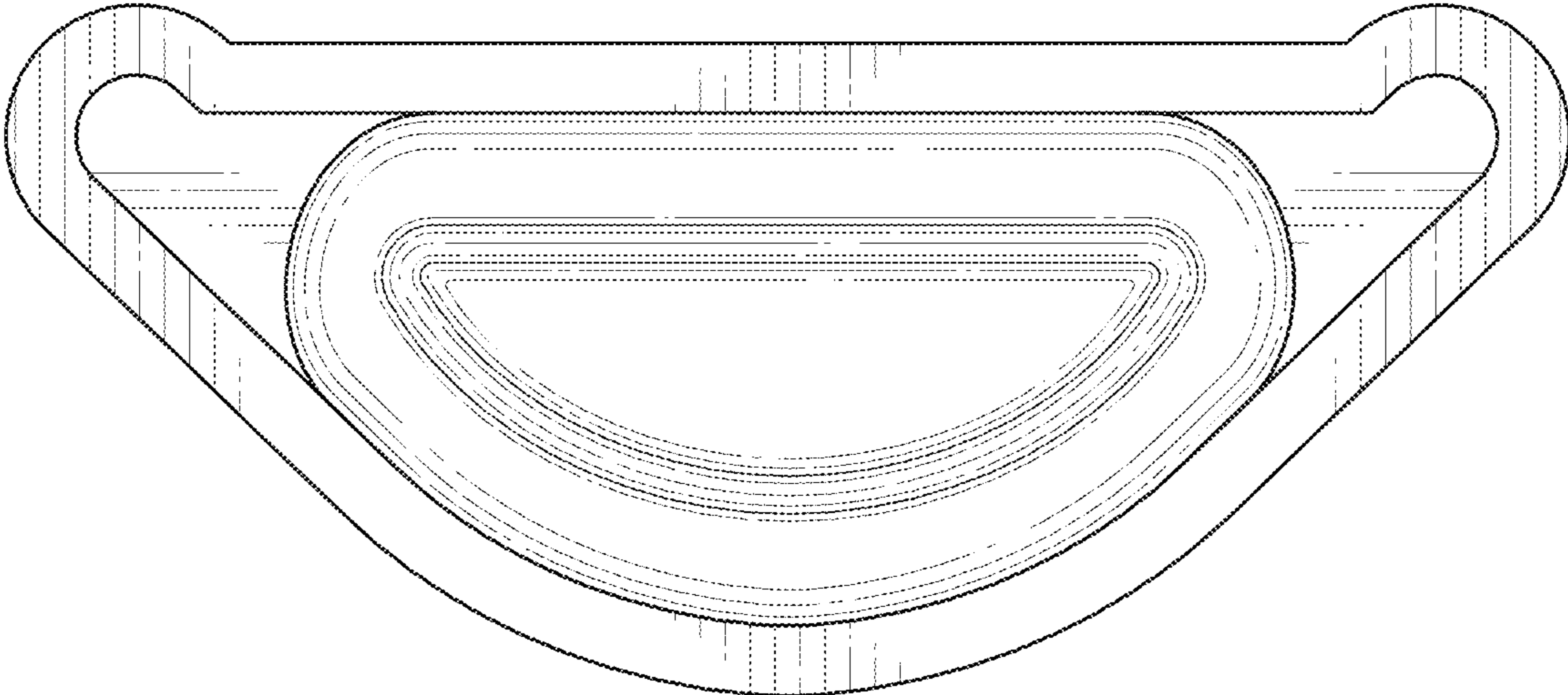

FIG. 31



**FIG. 32**



**FIG. 33**



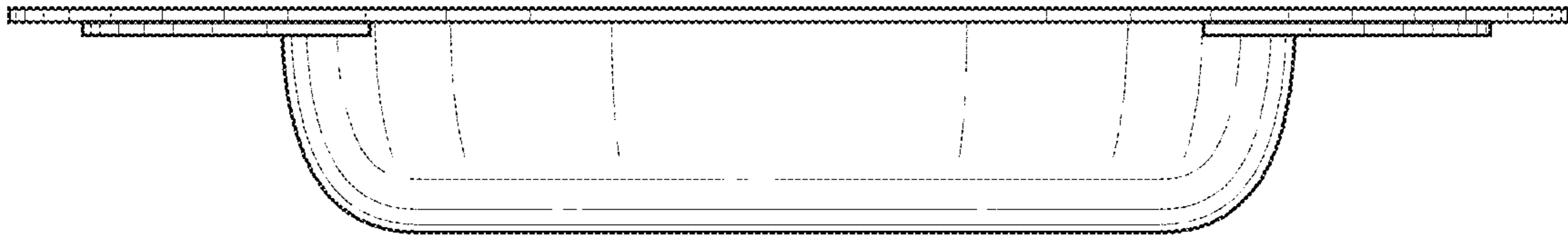

FIG. 34

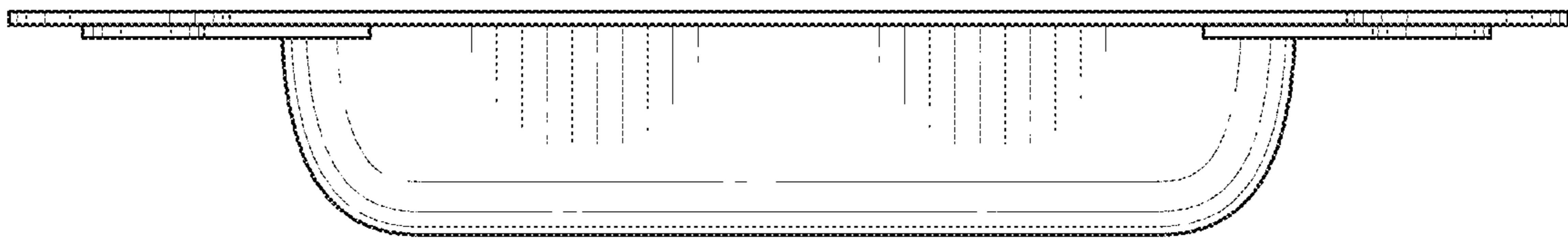
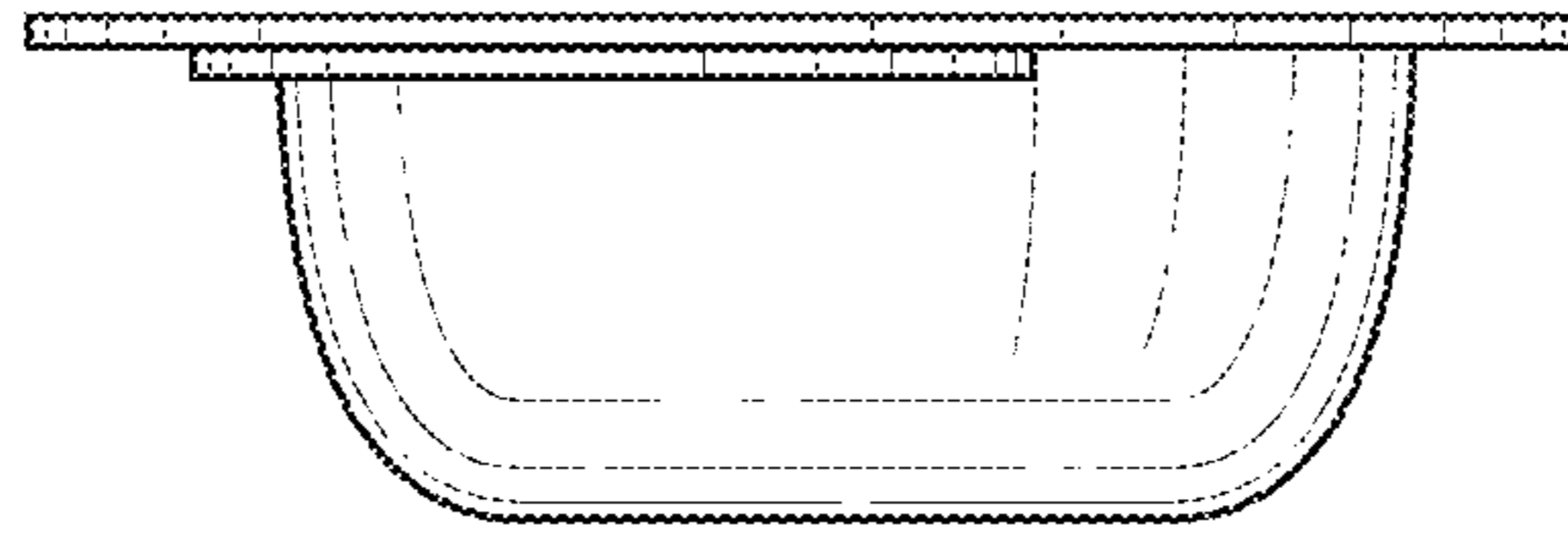

FIG. 35



**FIG. 36**



**FIG. 37**

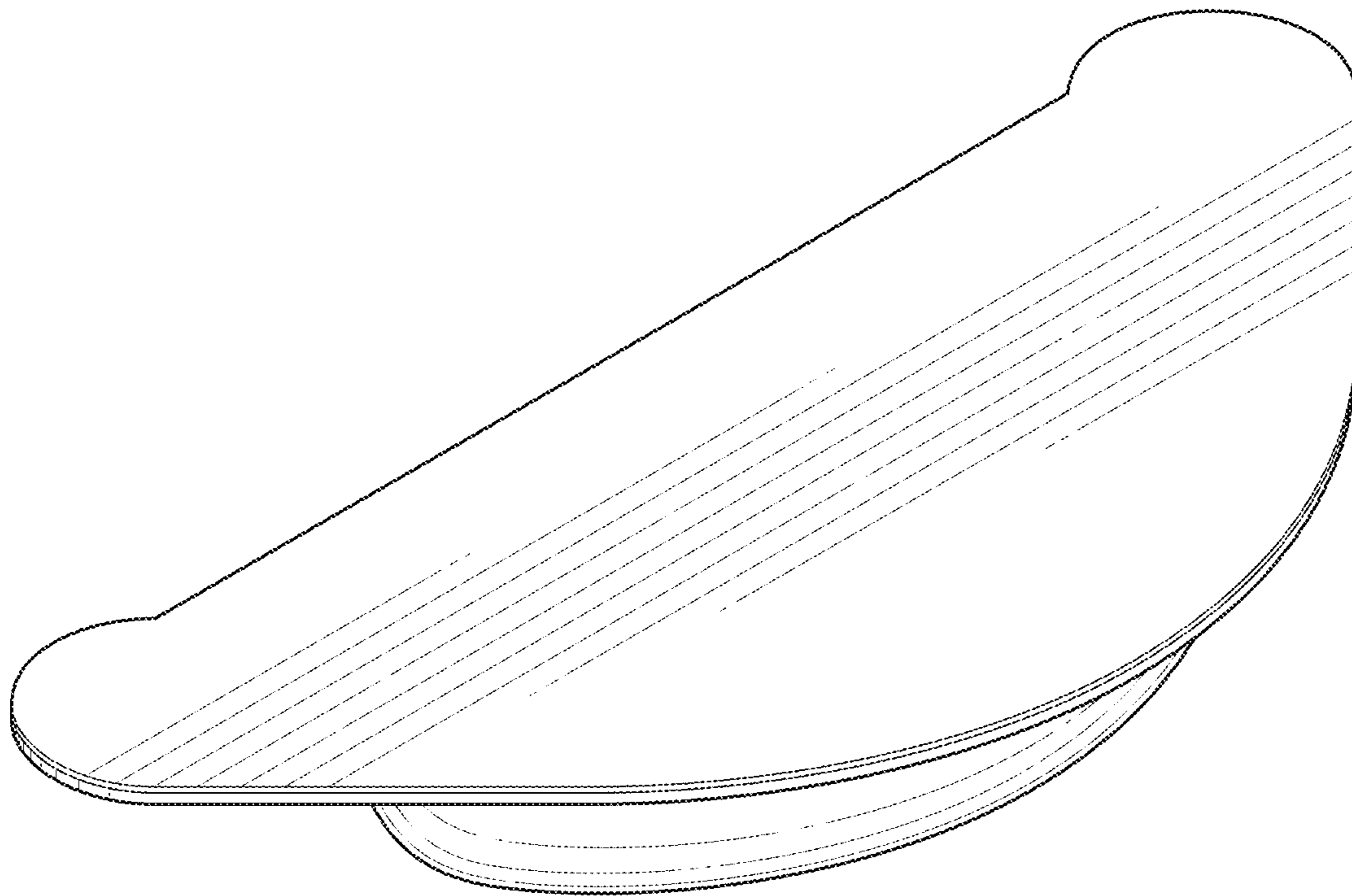

**FIG. 38**

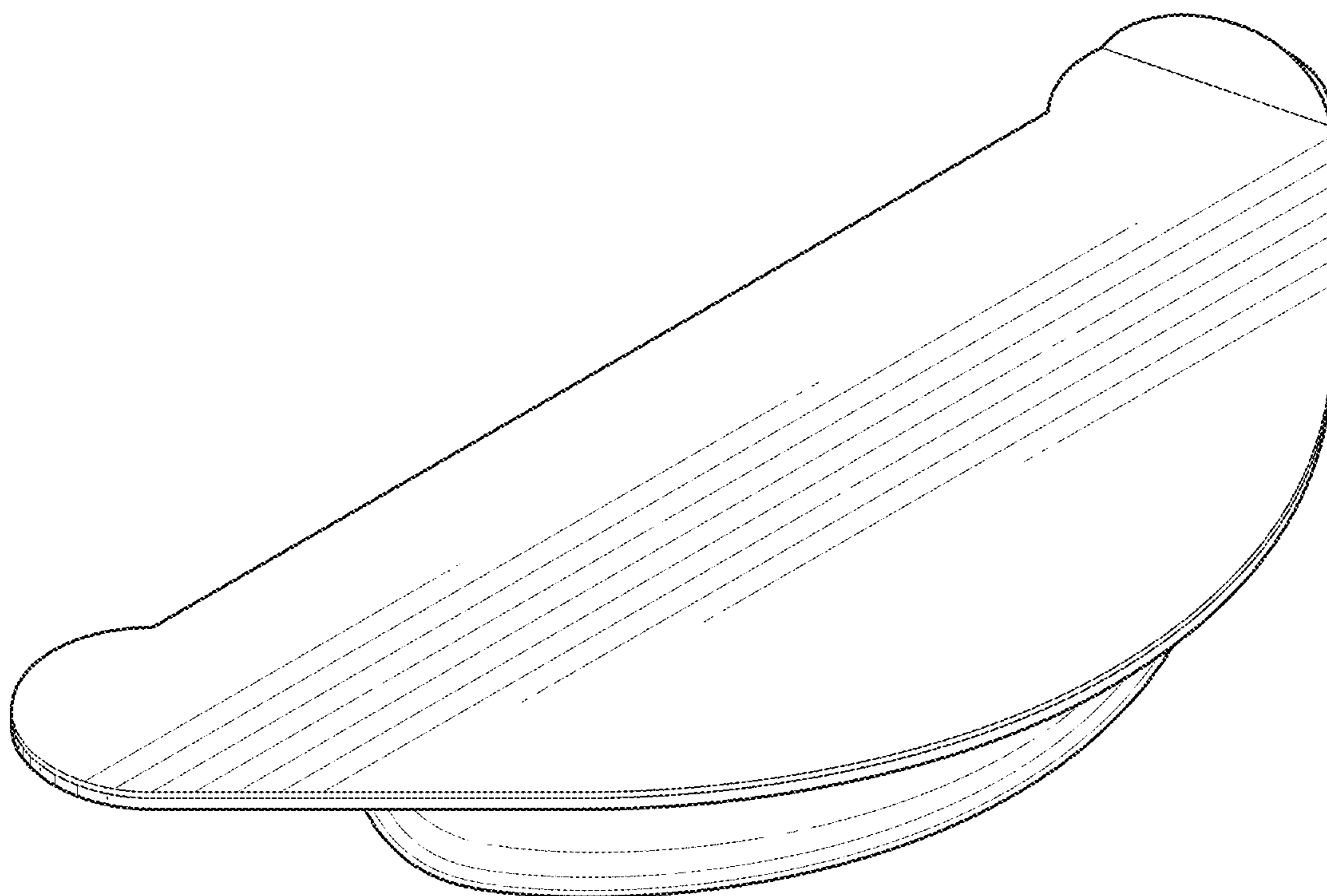

**FIG. 39**

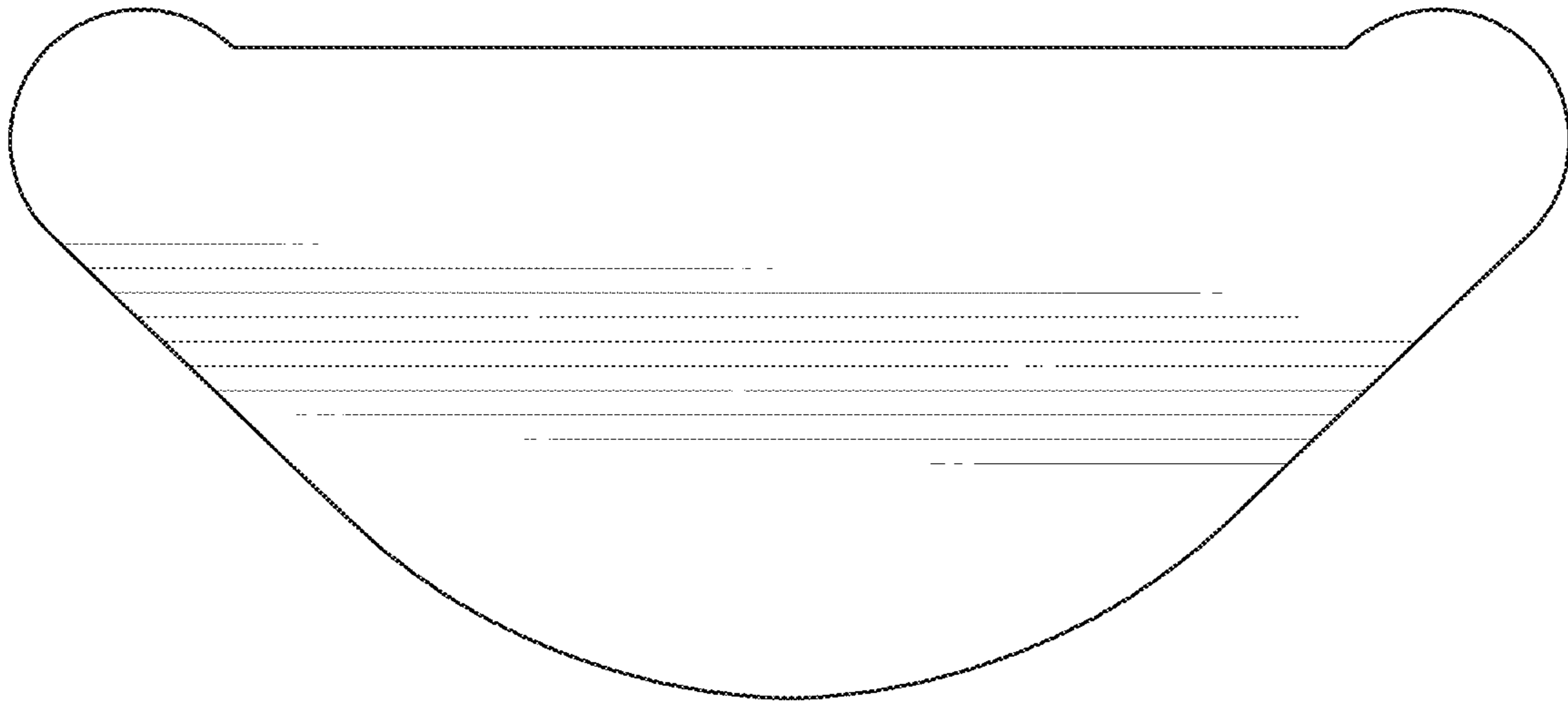

**FIG. 40**

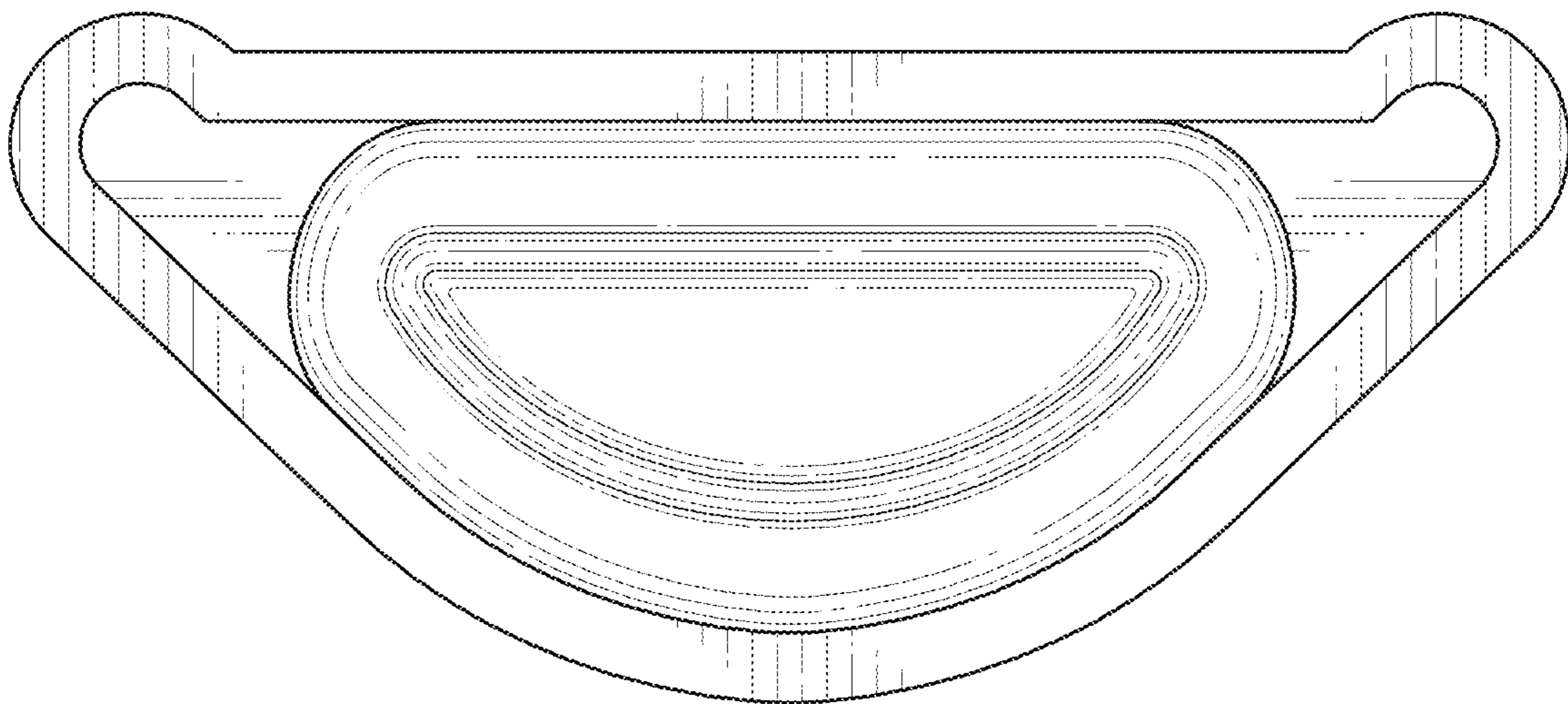

**FIG. 41**

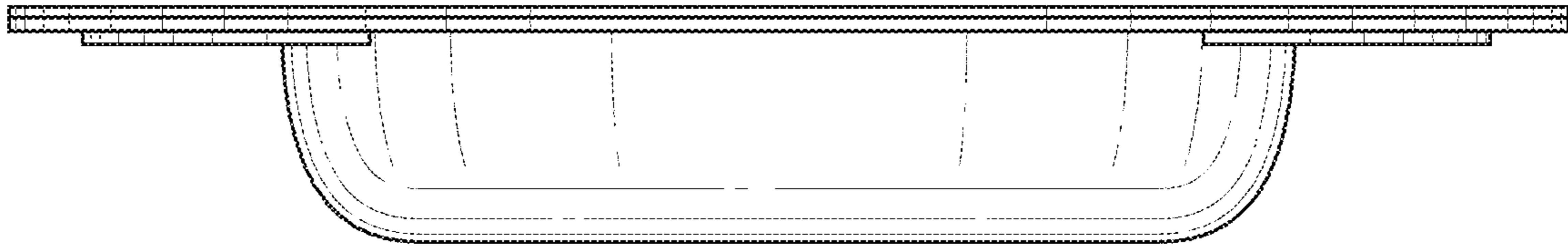

**FIG. 42**

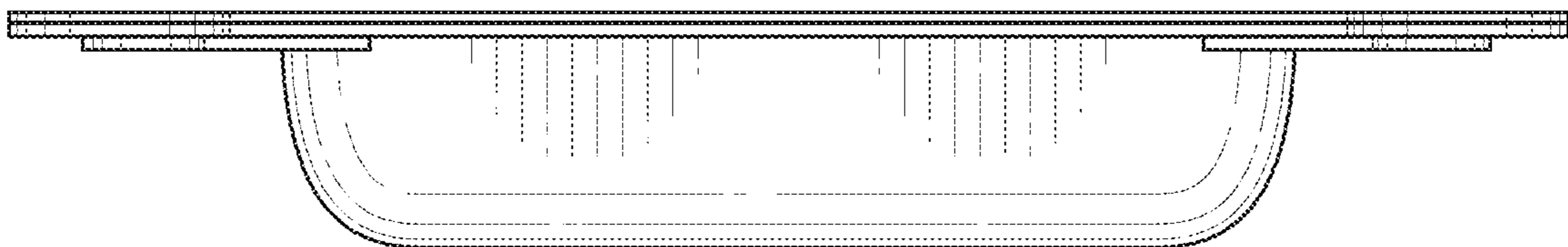

**FIG. 43**



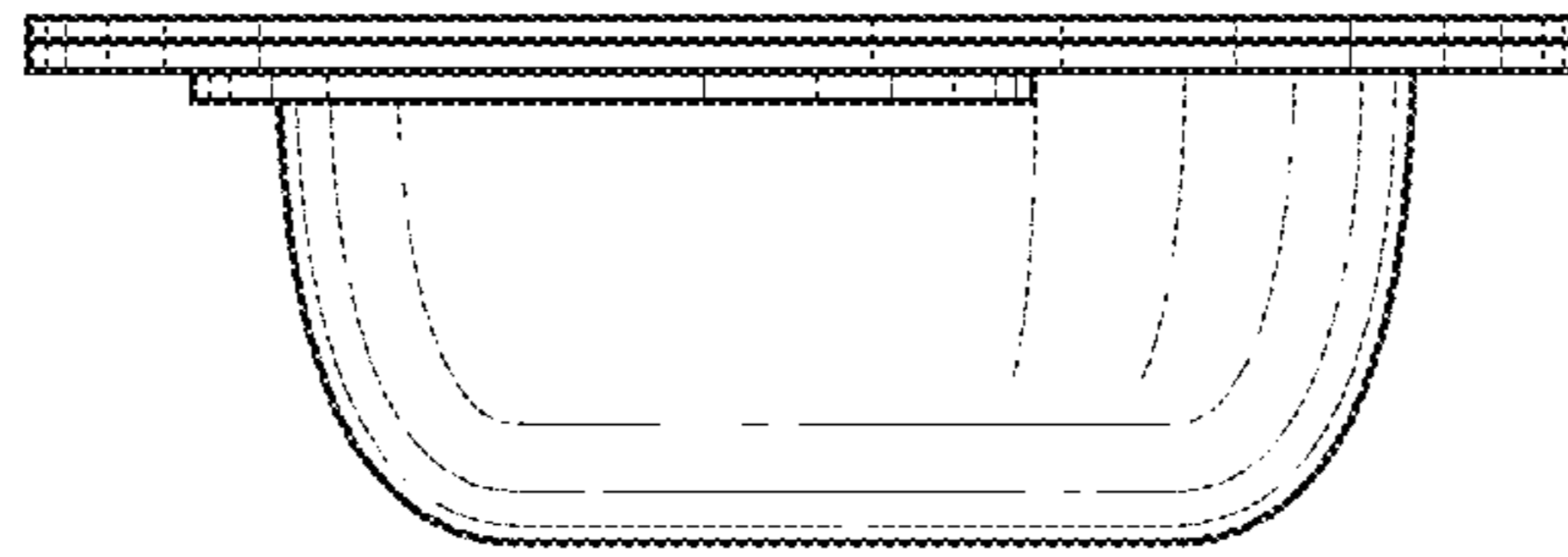

FIG. 44

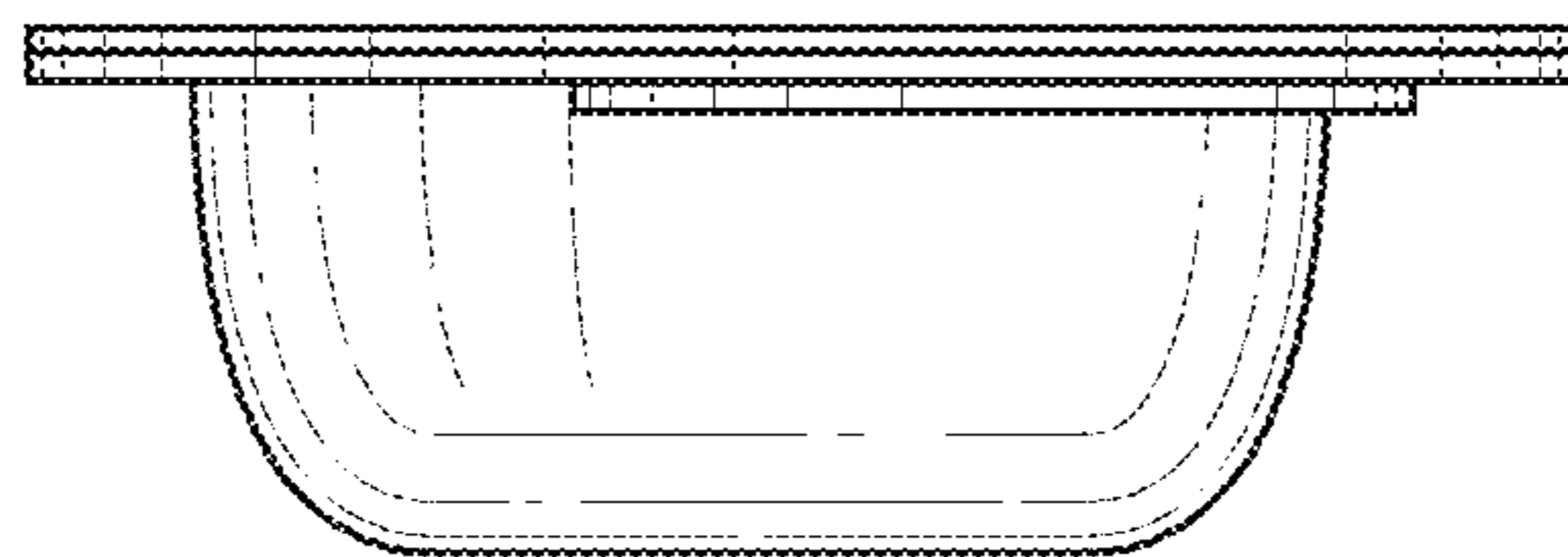

FIG. 45