



US00D986704S

(12) **United States Design Patent** (10) **Patent No.:** **US D986,704 S**  
**Lindsay** (45) **Date of Patent:** **\*\* May 23, 2023**

(54) **RING HOLDER**  
(71) Applicant: **Steve J. Lindsay**, Kearney, NE (US)  
(72) Inventor: **Steve J. Lindsay**, Kearney, NE (US)  
(\*\*) Term: **15 Years**  
(21) Appl. No.: **29/806,994**  
(22) Filed: **Sep. 8, 2021**  
(51) **LOC (14) Cl.** ..... **08-04**  
(52) **U.S. Cl.**  
USPC ..... **D8/72**  
(58) **Field of Classification Search**  
USPC ..... D8/71-74, 394-399, 59  
CPC ..... B25B 1/00; B25B 5/00  
See application file for complete search history.

D786,056 S \* 5/2017 Baiz ..... D8/387  
D792,201 S \* 7/2017 Baiz ..... D8/387  
D792,203 S \* 7/2017 Baiz ..... D8/397  
D796,947 S \* 9/2017 Hsu ..... D8/397  
D809,837 S \* 2/2018 Gao ..... D6/682.2  
D821,188 S \* 6/2018 Smullen ..... D8/396  
D827,405 S \* 9/2018 Chun ..... D8/72  
D841,457 S \* 2/2019 Brown ..... D8/399

\* cited by examiner

*Primary Examiner* — David G Muller

(74) *Attorney, Agent, or Firm* — Ryan T. Grace; Advent, LLP

(57) **CLAIM**

The ornamental design for a ring holder, as shown and described.

**DESCRIPTION**

FIG. 1 is an isometric view of a ring holder.  
FIG. 2 is another isometric view of the ring holder of FIG. 1.  
FIG. 3 is a top plan view of the ring holder of FIG. 1.  
FIG. 4 is a bottom view of the ring holder of FIG. 1.  
FIG. 5 is front view of the ring holder of FIG. 1.  
FIG. 6 a rear view of the ring holder of FIG. 1.  
FIG. 7 is a left side view of the ring holder of FIG. 1; and,  
FIG. 8 is a right side view of the ring holder of FIG. 1.  
Portions of FIGS. 1 through 8 are shown in broken lines and dash-dot-dash boundary lines illustrating portions of the article that form no part of the claimed design.

**1 Claim, 7 Drawing Sheets**

(56) **References Cited**  
U.S. PATENT DOCUMENTS

D243,154 S \* 1/1977 Dieme ..... D8/387  
D332,562 S \* 1/1993 Fremont ..... D8/73  
5,535,878 A \* 7/1996 Reed ..... A47F 7/02  
206/493  
D387,657 S \* 12/1997 Holmes ..... D8/397  
D389,640 S \* 1/1998 MacDonald ..... D3/207  
D484,784 S \* 1/2004 Siragusa ..... D8/394  
D488,715 S \* 4/2004 Plumer ..... D8/397  
D575,556 S \* 8/2008 Rohkar, Jr. .... D6/682  
D641,614 S \* 7/2011 Pontaoe ..... D8/394  
D679,177 S \* 4/2013 Craig ..... D8/395  
D727,720 S \* 4/2015 Schermer ..... D8/397  
D780,562 S \* 3/2017 Baiz ..... D8/387

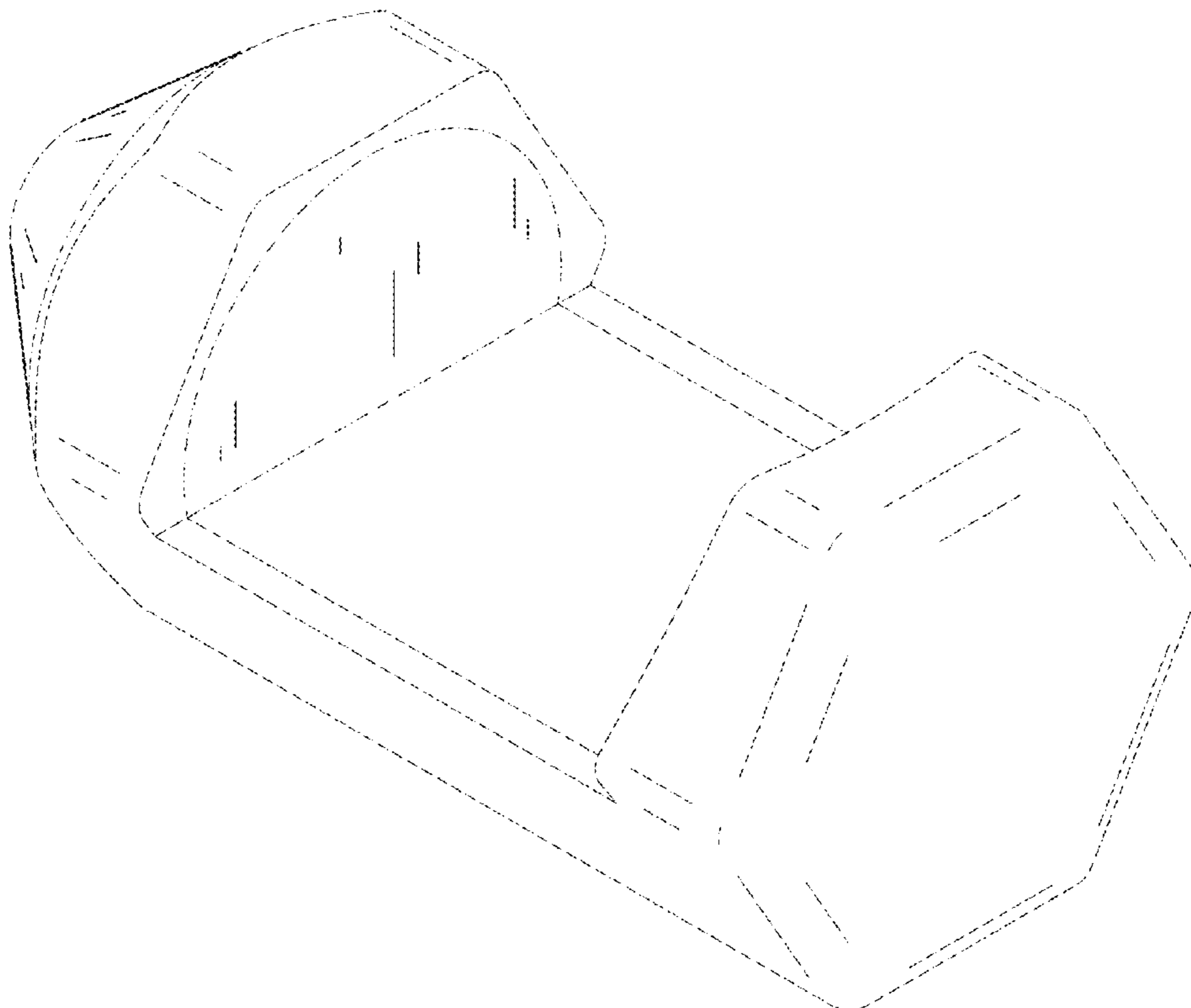

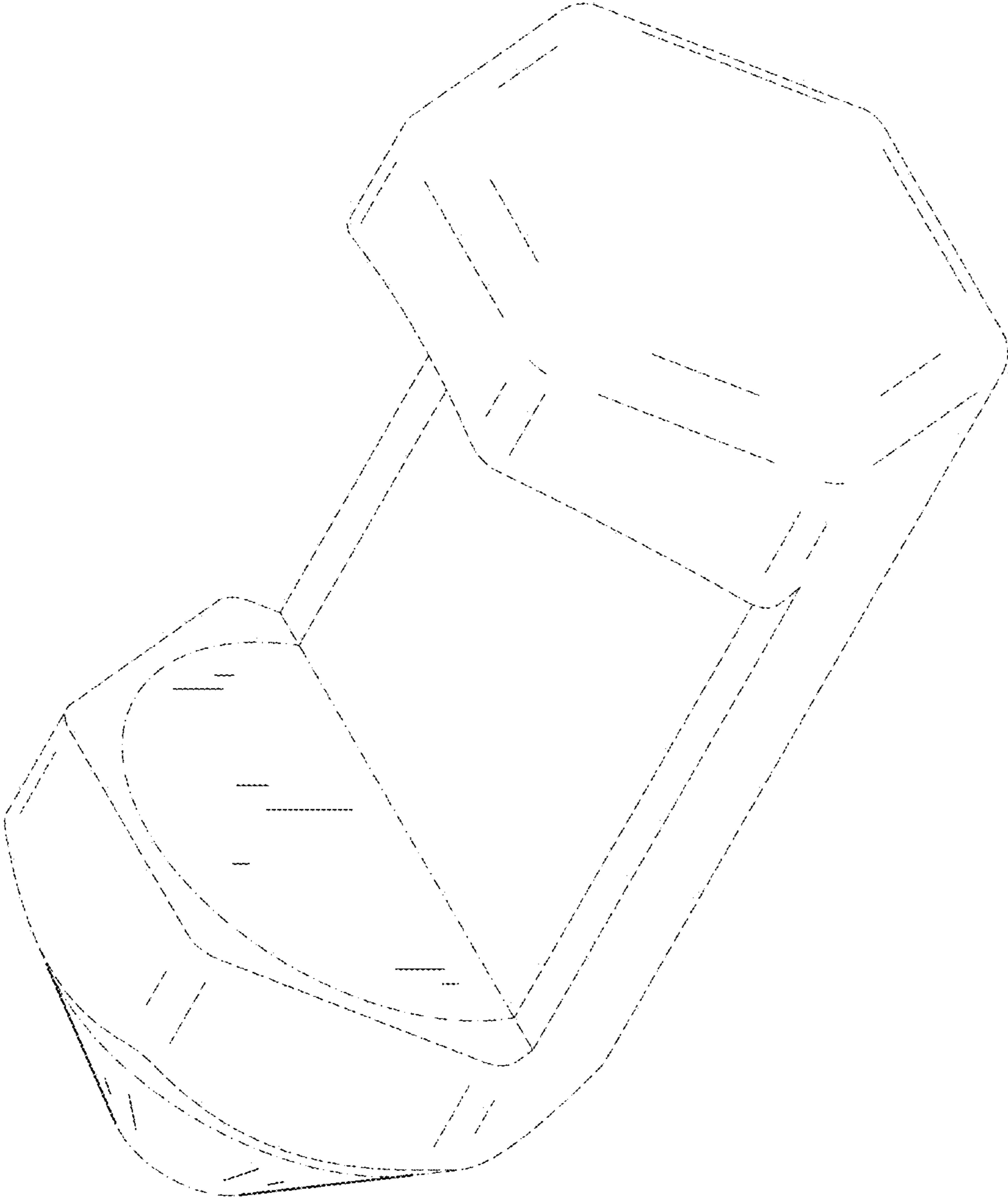

FIG. 1

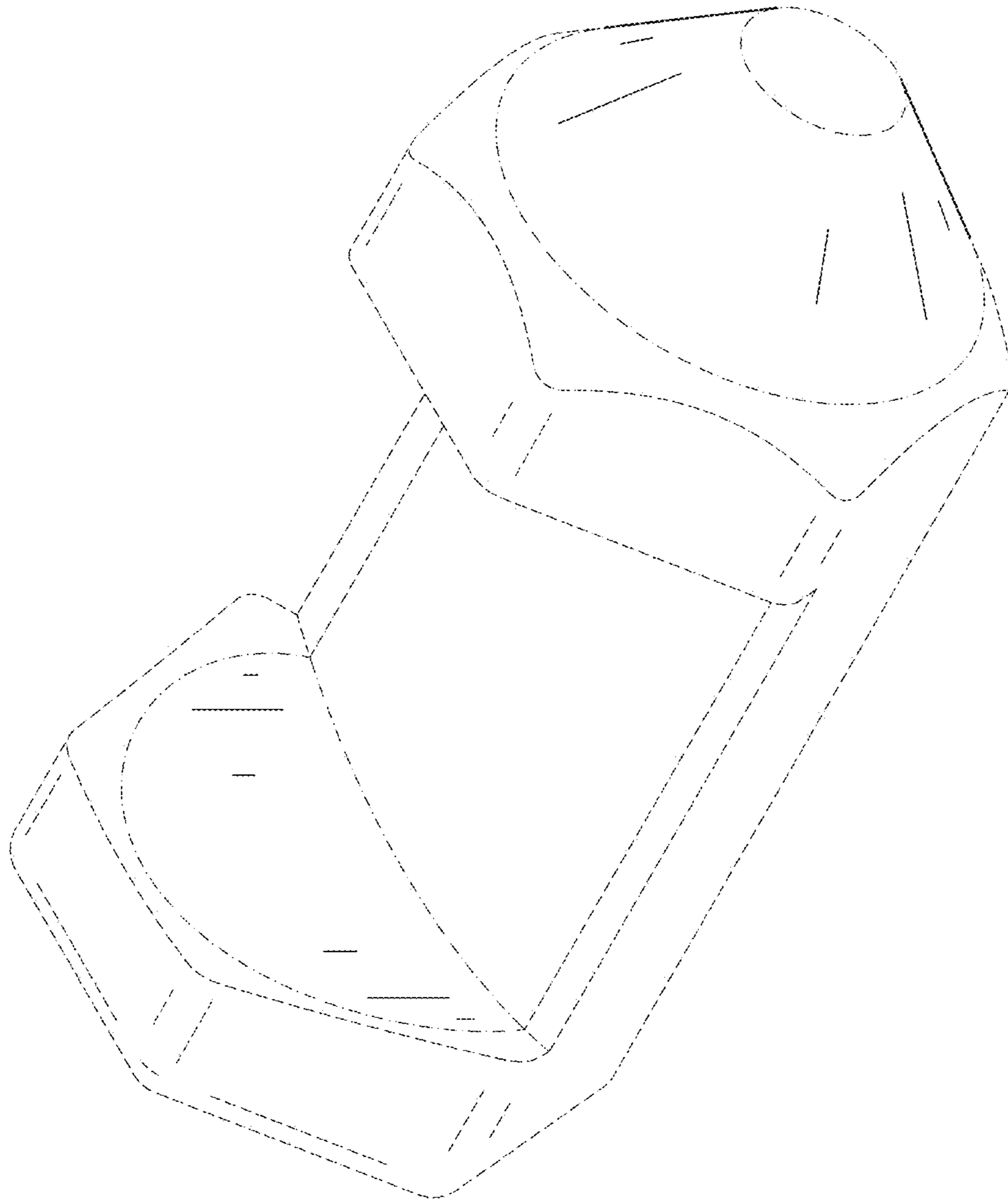
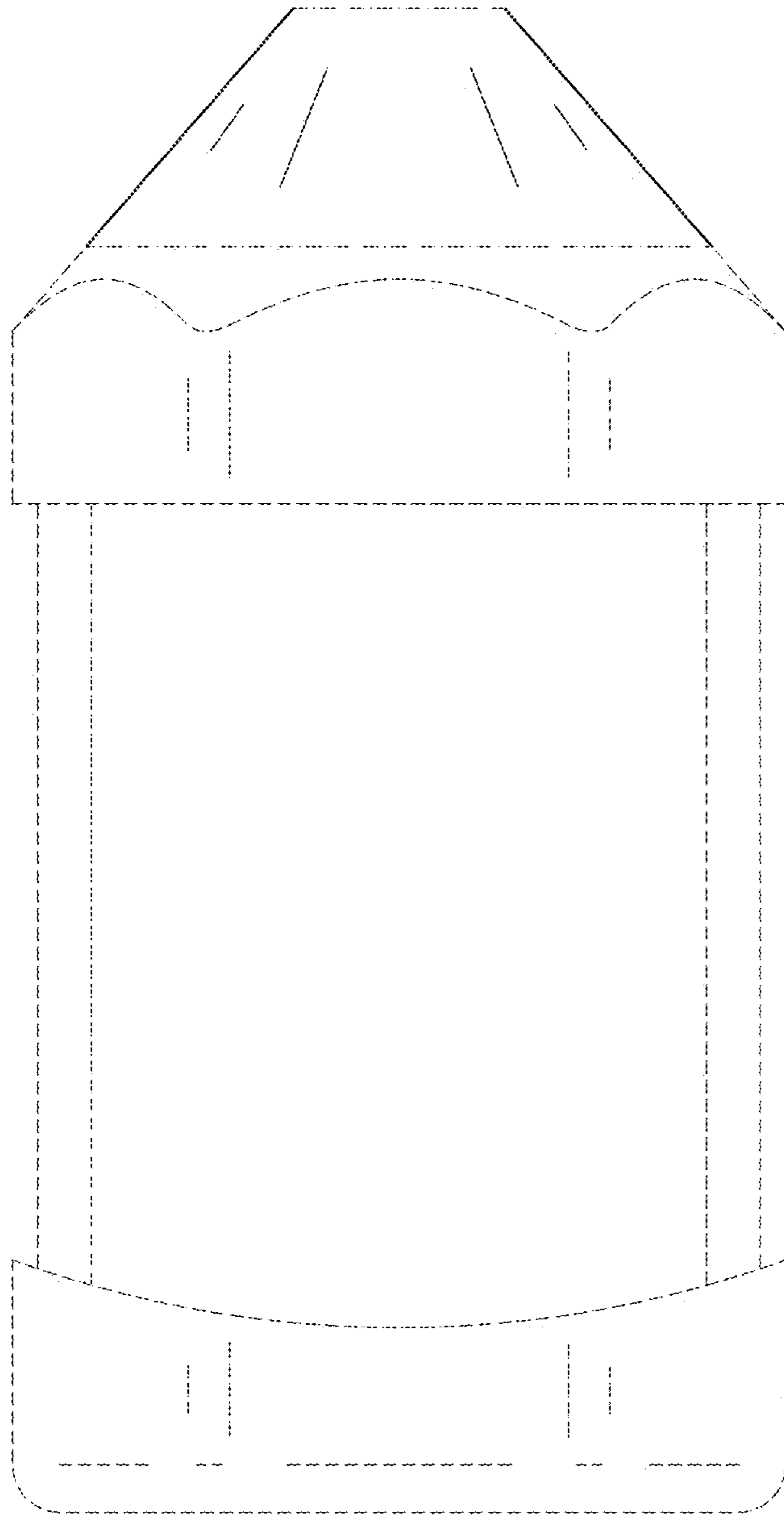

FIG. 2



**FIG. 3**

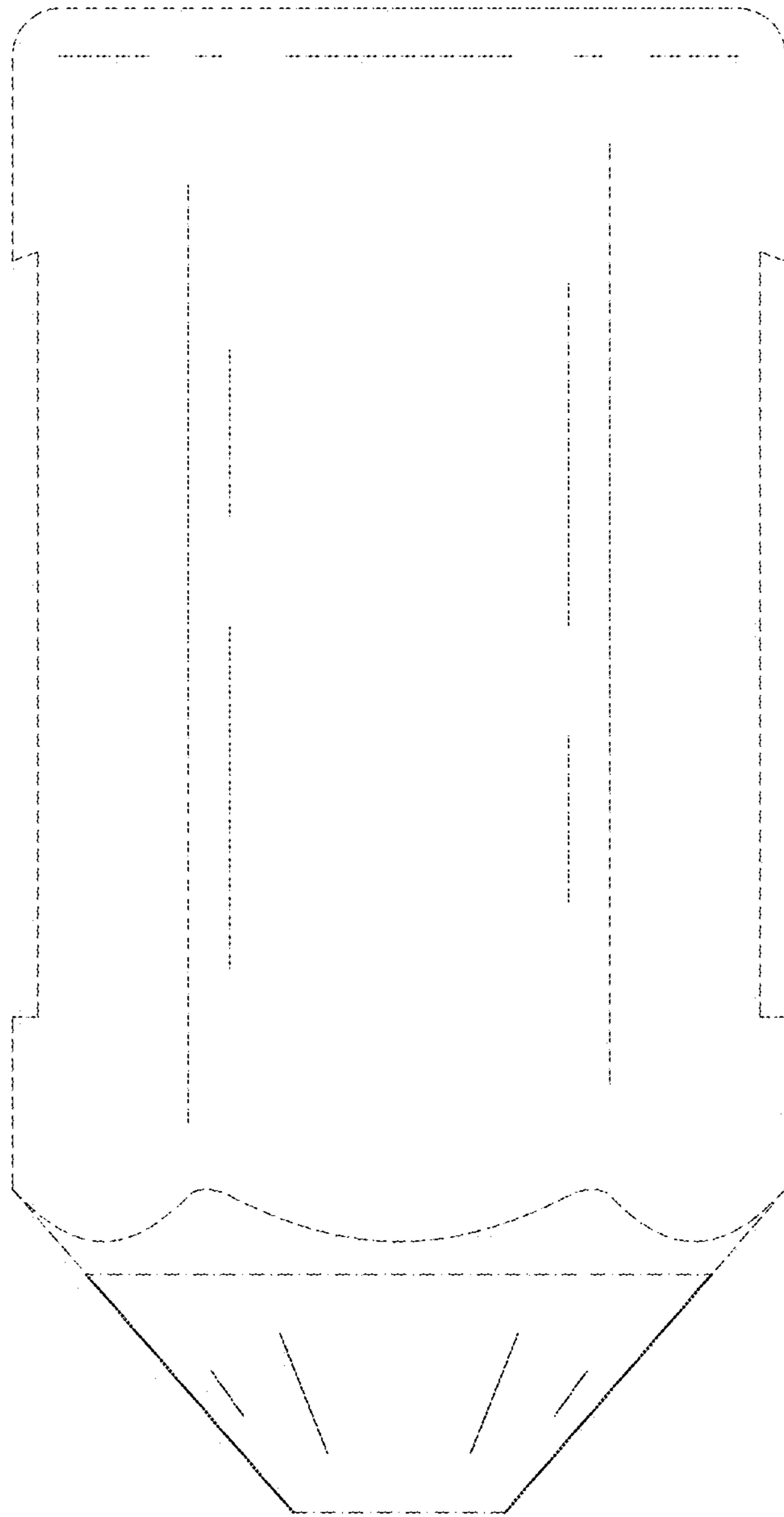
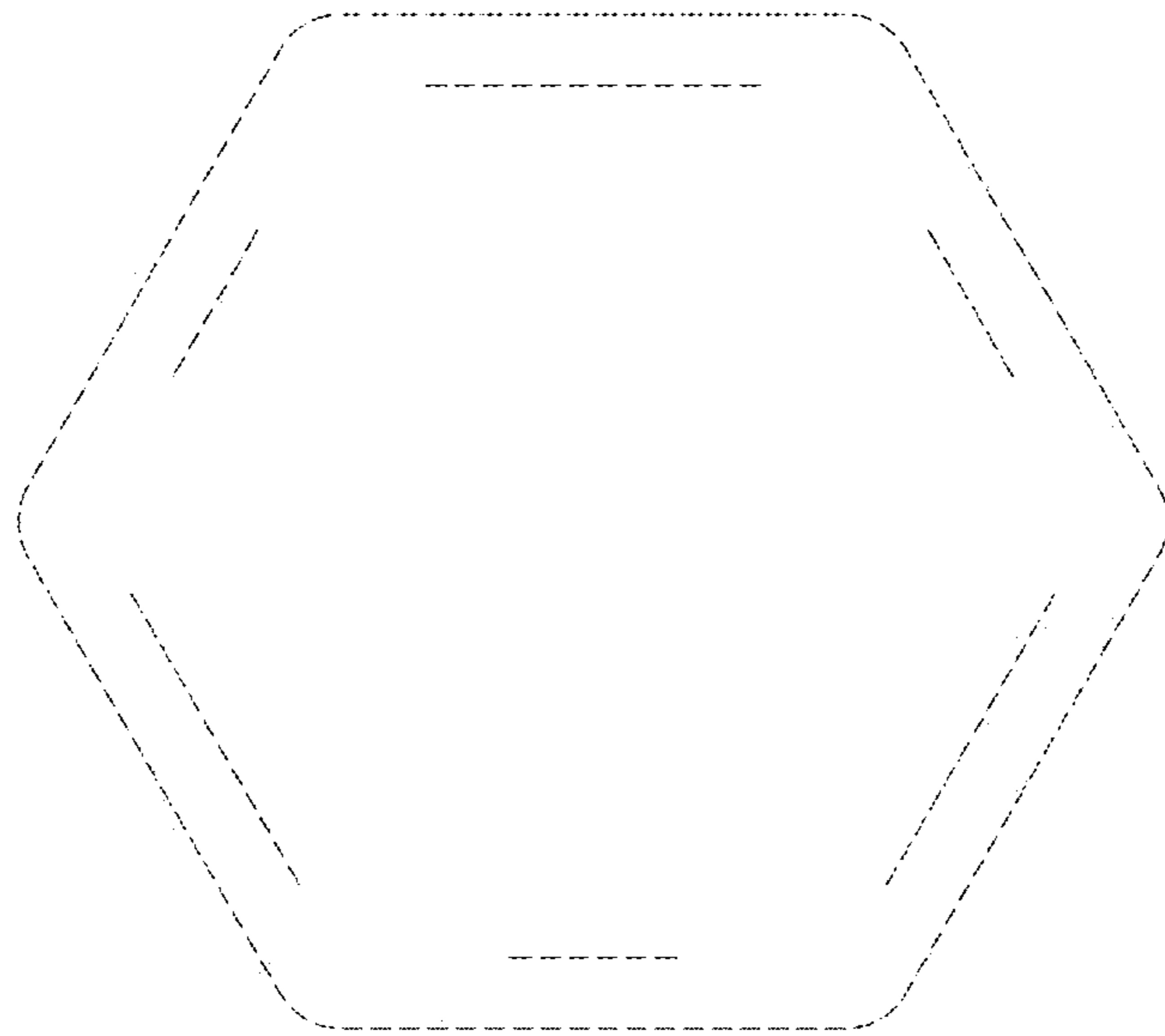
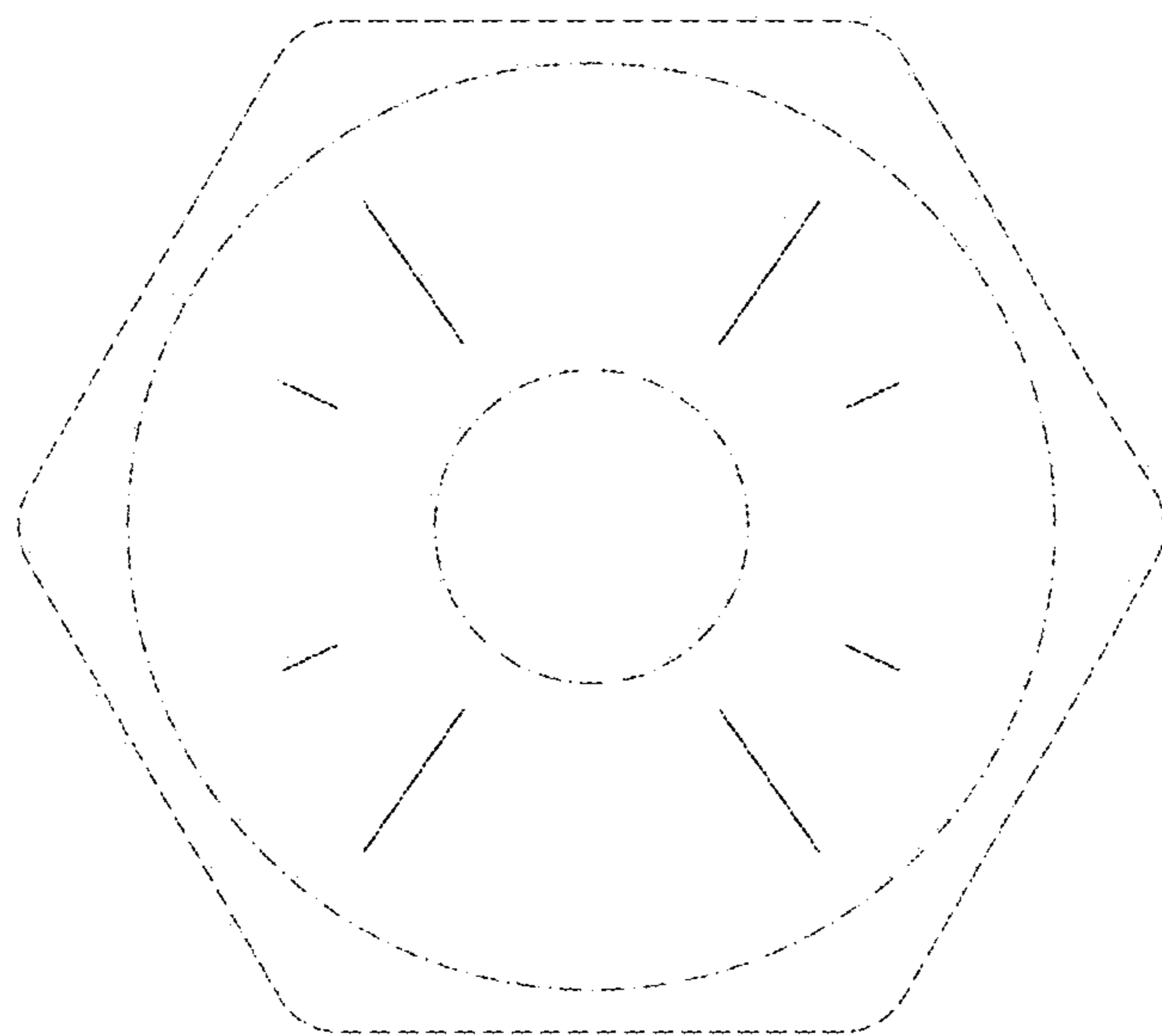

FIG. 4



**FIG. 5**



**FIG. 6**

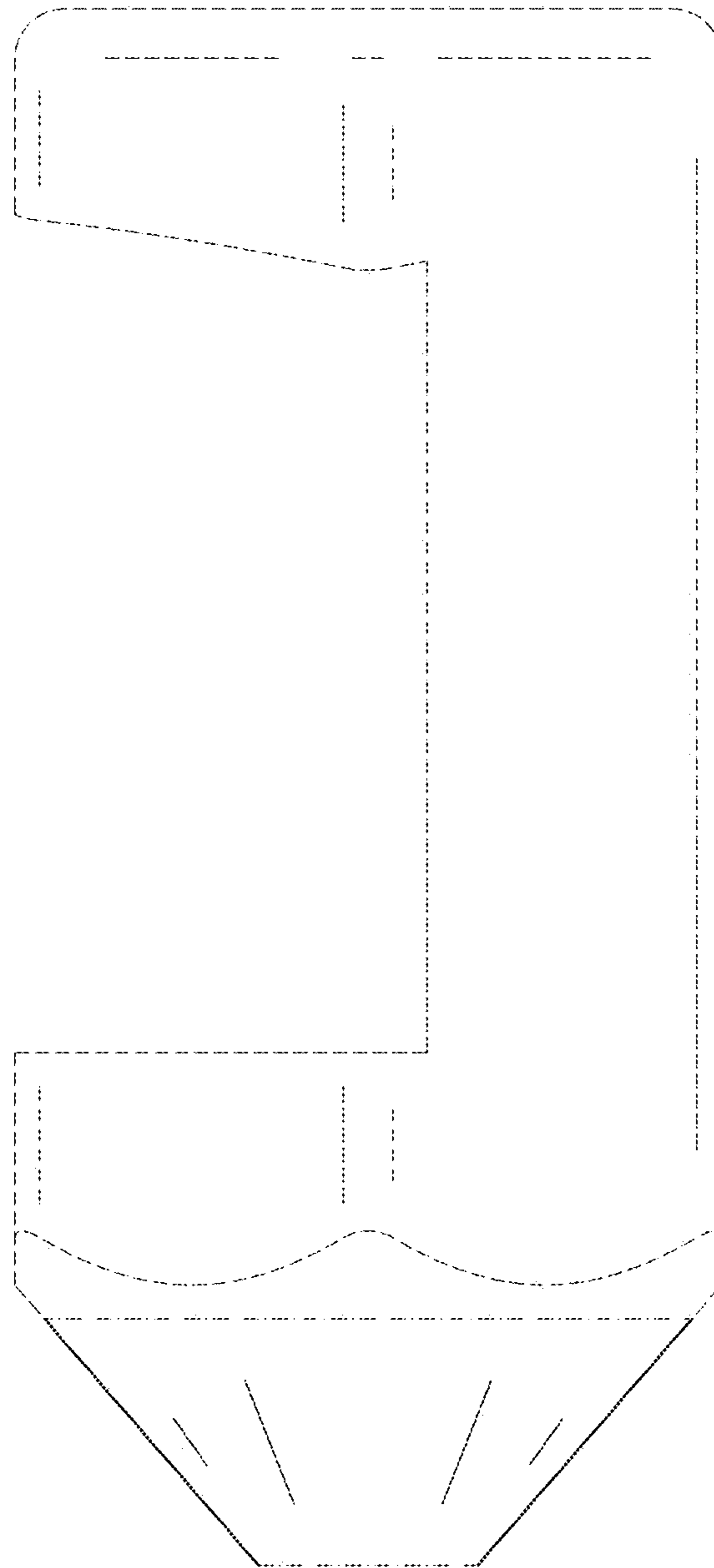

FIG. 7

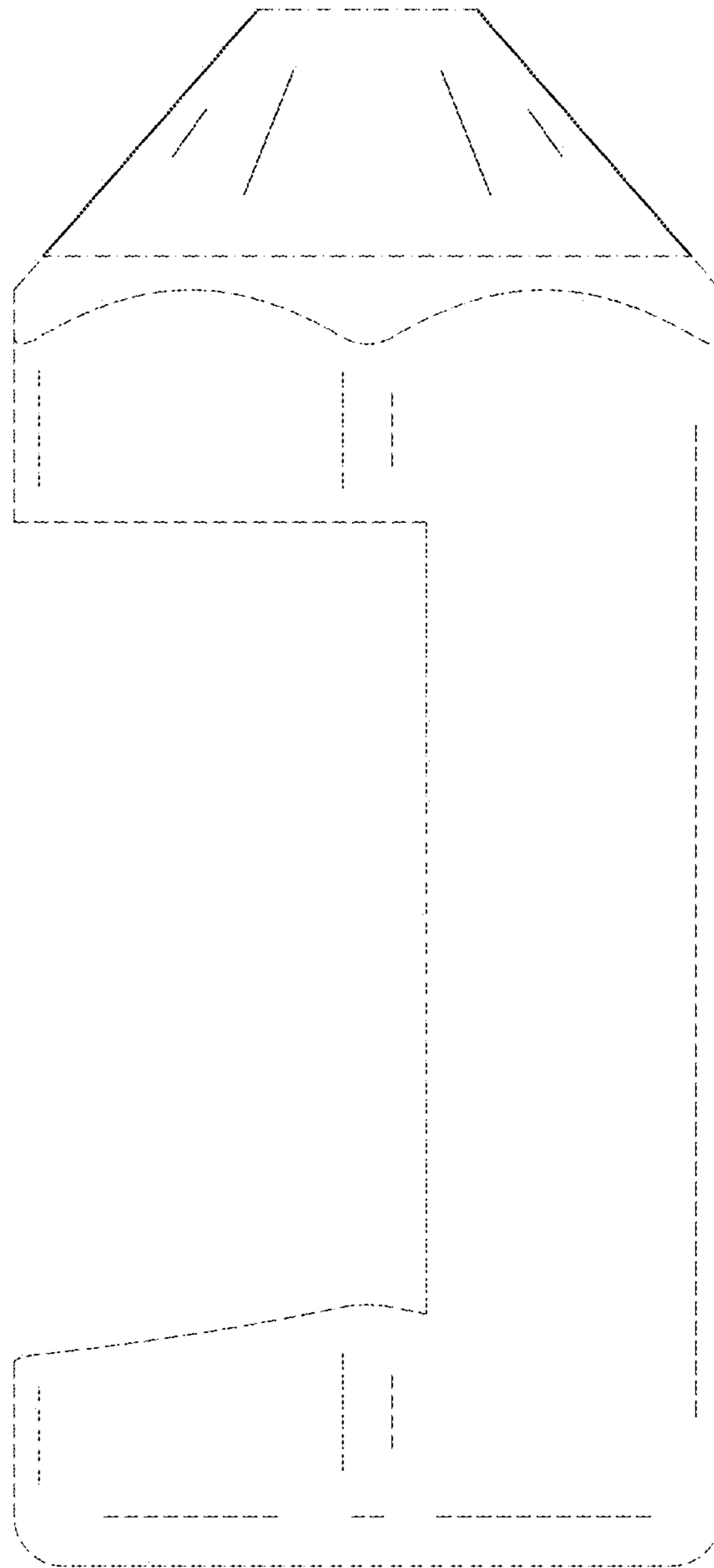

FIG. 8