



US00D986663S

(12) **United States Design Patent** (10) **Patent No.:** **US D986,663 S**
Yamamoto (45) **Date of Patent:** **** May 23, 2023**

(54) **COFFEE POT**

FOREIGN PATENT DOCUMENTS

(71) Applicant: **ZOJIRUSHI CORPORATION**, Osaka (JP)

CA 38775 * 2/1975
WO WO-D217385-001 * 5/2022

(72) Inventor: **Saya Yamamoto**, Osaka (JP)

OTHER PUBLICATIONS

(73) Assignee: **Zojirushi Corporation**, Osaka (JP)

Zojirushi America Corporation, Product of the Month: Zojirushi Fresh Brew Vacuum Insulated STainless French Press SK-XAE10, Jul. 12, 2022, Zojirushi Blog, www.zojirushi.com/blog/product-of-the-month-zojirushi-fresh-brew-vacuum-insulated-stainless-french-press-sk-xae10/ (Year: 2022).*

(**) Term: **15 Years**

(21) Appl. No.: **35/514,248**

(22) Filed: **Nov. 12, 2021**

Primary Examiner — Joseph Kukella

(80) **Hague Agreement Data**

Assistant Examiner — Arva P Adams

Int. Filing Date: **Nov. 12, 2021**

(74) *Attorney, Agent, or Firm* — Sterne, Kessler, Goldstein & Fox P.L.L.C.

Int. Reg. No.: **DM/217385**

Int. Reg. Date: **Nov. 12, 2021**

Int. Reg. Pub. Date: **May 13, 2022**

(51) **LOC (14) Cl.** **07-01**

(57) **CLAIM**

(52) **U.S. Cl.**

The ornamental design for a coffee pot, as shown and described.

USPC **D7/319**; D7/317

(58) **Field of Classification Search**

DESCRIPTION

USPC D7/300–303, 305, 314, 316–322;

D9/516, 523, 544, 545, 528, 531, 535,

D9/536, 539, 540, 549; D23/207, 209

CPC .. A47J 31/18; A47J 31/20; A47J 31/24; A47J

31/38; A47J 45/067; A47J 45/078

See application file for complete search history.

- 1. Coffee pot
- 1.1 : Perspective
- 1.2 : Perspective
- 1.3 : Front
- 1.4 : Back
- 1.5 : Left
- 1.6 : Right
- 1.7 : Top
- 1.8 : Bottom

(56) **References Cited**

U.S. PATENT DOCUMENTS

D184,715 S * 3/1959 Cornelius D7/317

3,174,424 A * 3/1965 Serio A47J 31/053

210/474

3,282,196 A * 11/1966 Manship A47J 31/053

220/759

D208,567 S * 9/1967 Mitchell D7/318

D219,056 S * 10/1970 Gibson A47J 31/053

D7/317

D232,897 S * 9/1974 Kemnitzer A47G 19/127

D7/317

Reproduction 1.1 is a front perspective view; reproduction 1.2 is a back perspective view; reproduction 1.3 is a front view; reproduction 1.4 is a back view; reproduction 1.5 is a left view; reproduction 1.6 is a right view; reproduction 1.7 is a top view; and reproduction 1.8 is a bottom view. The dashed broken lines in the reproductions represent portions of the coffee pot that form no part of the claimed design.

(Continued)

1 Claim, 8 Drawing Sheets

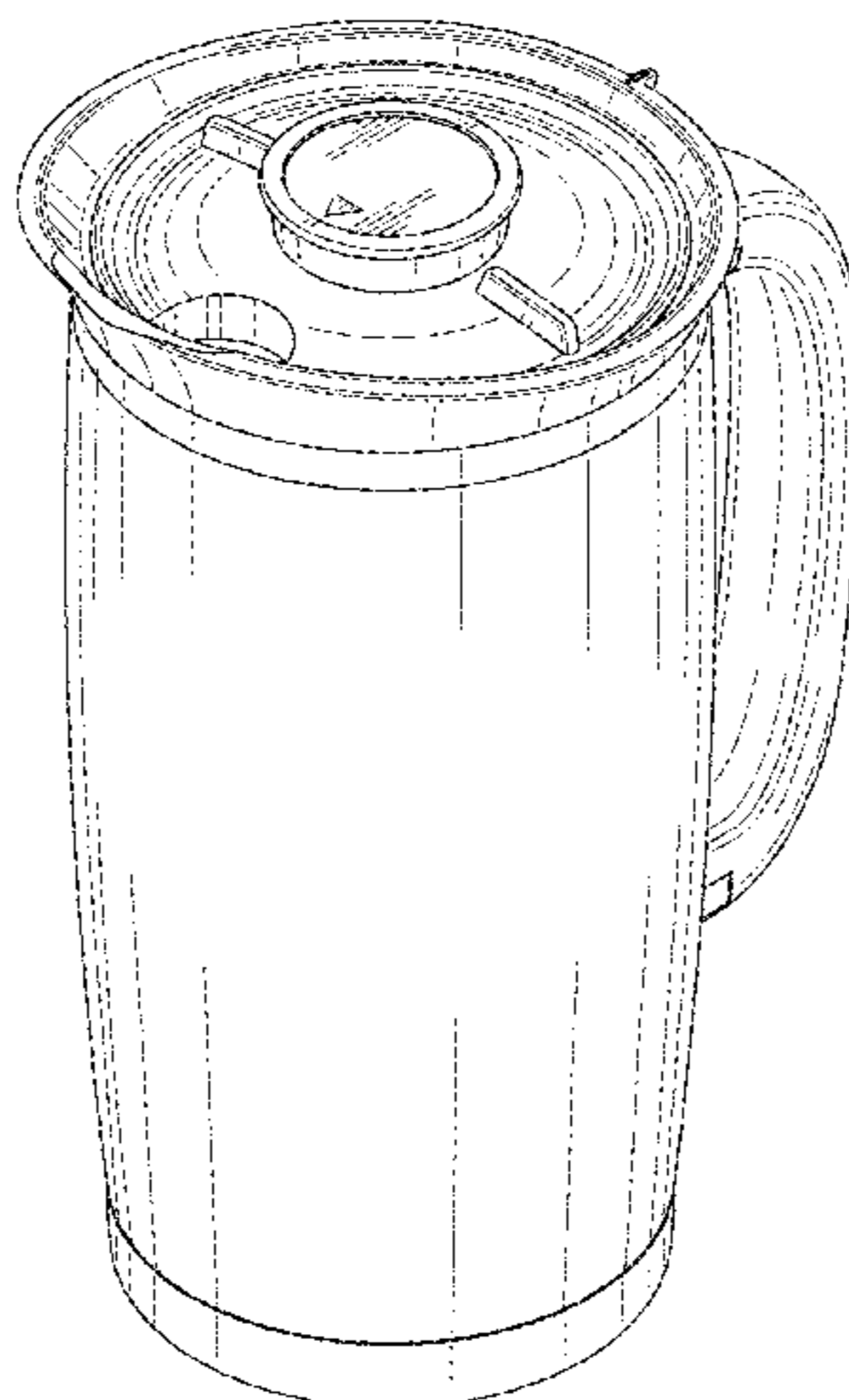

(56)

References Cited

U.S. PATENT DOCUMENTS

3,926,350	A *	12/1975	Muehlhausen	A47G 19/12
				D7/317
D486,032	S *	2/2004	Leung	D7/319
D557,978	S	12/2007	Bodum	
D579,720	S	11/2008	Rohe	
D610,859	S	3/2010	Lundstrom	
D616,248	S	5/2010	George	
D624,348	S	9/2010	Bodum	
D648,592	S	11/2011	Bodum	
D659,474	S	5/2012	Wahl et al.	
D703,479	S	4/2014	Norland et al.	
D714,581	S	10/2014	Shao	
D720,174	S *	12/2014	Melzer	D7/319
D730,675	S *	6/2015	Williams	A47G 19/12
				D7/317
D738,670	S *	9/2015	Sands	D7/319
D763,042	S	8/2016	Shao et al.	
D789,726	S	6/2017	Adelaju	
D802,978	S *	11/2017	Kestenbaum	D7/318
D815,874	S	4/2018	Chung et al.	
D833,196	S	11/2018	Mutch et al.	
D889,894	S	7/2020	Hu	
D899,173	S	10/2020	Burns et al.	
D901,979	S	11/2020	Gilmore, III et al.	
2015/0201771	A1 *	7/2015	Elsaden	A47G 19/127
				222/484

* cited by examiner

1.1

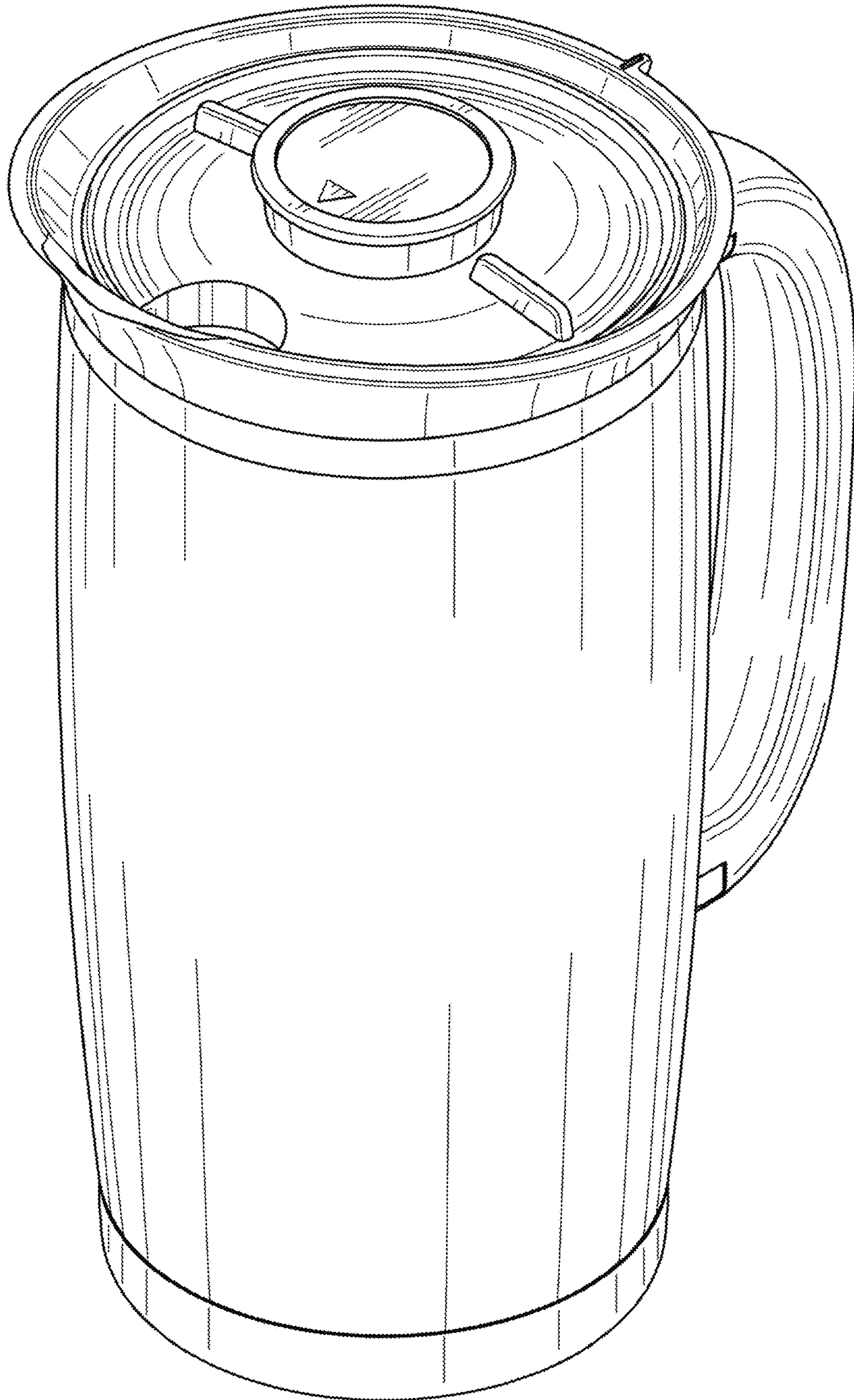

1.2

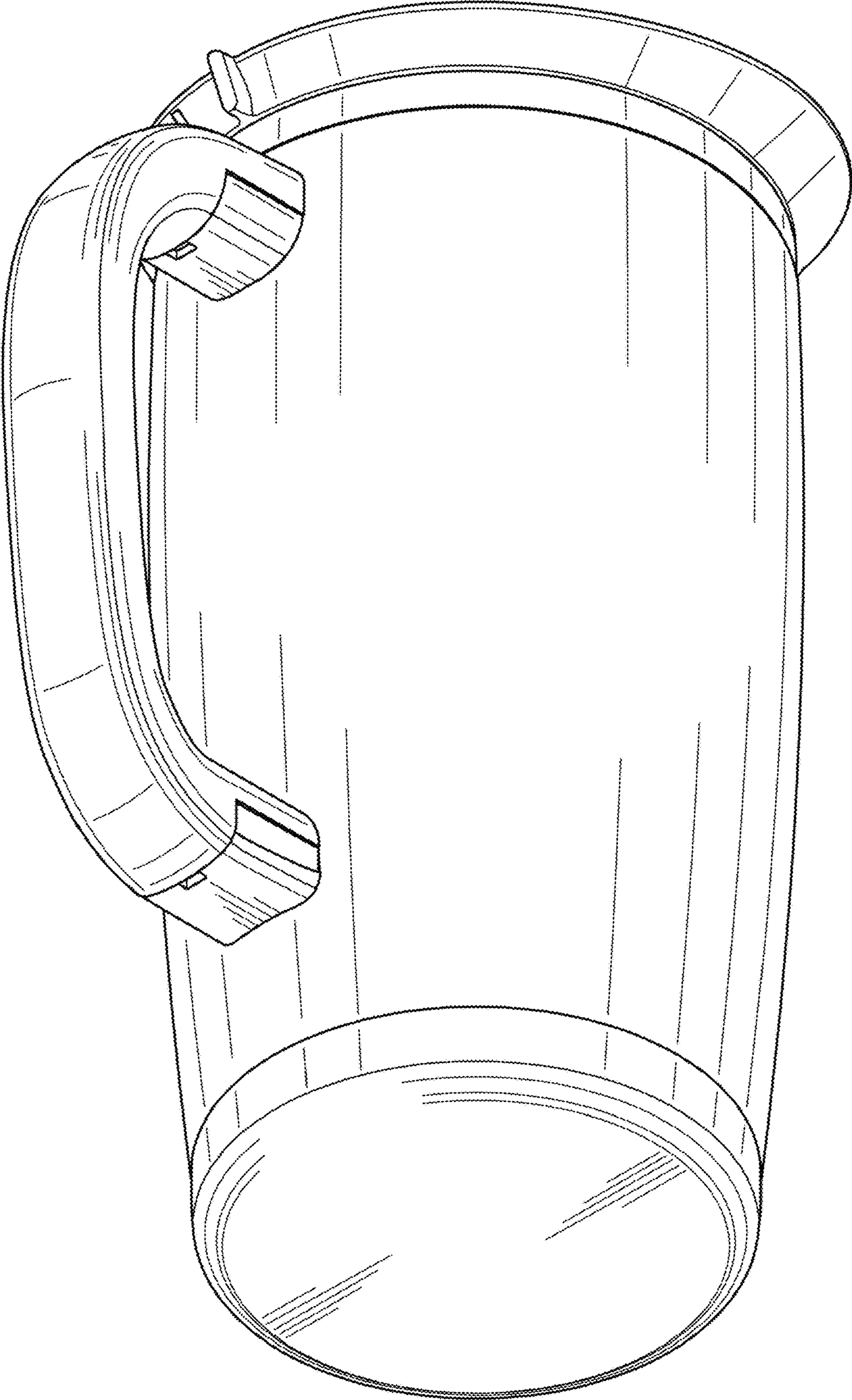

1.3

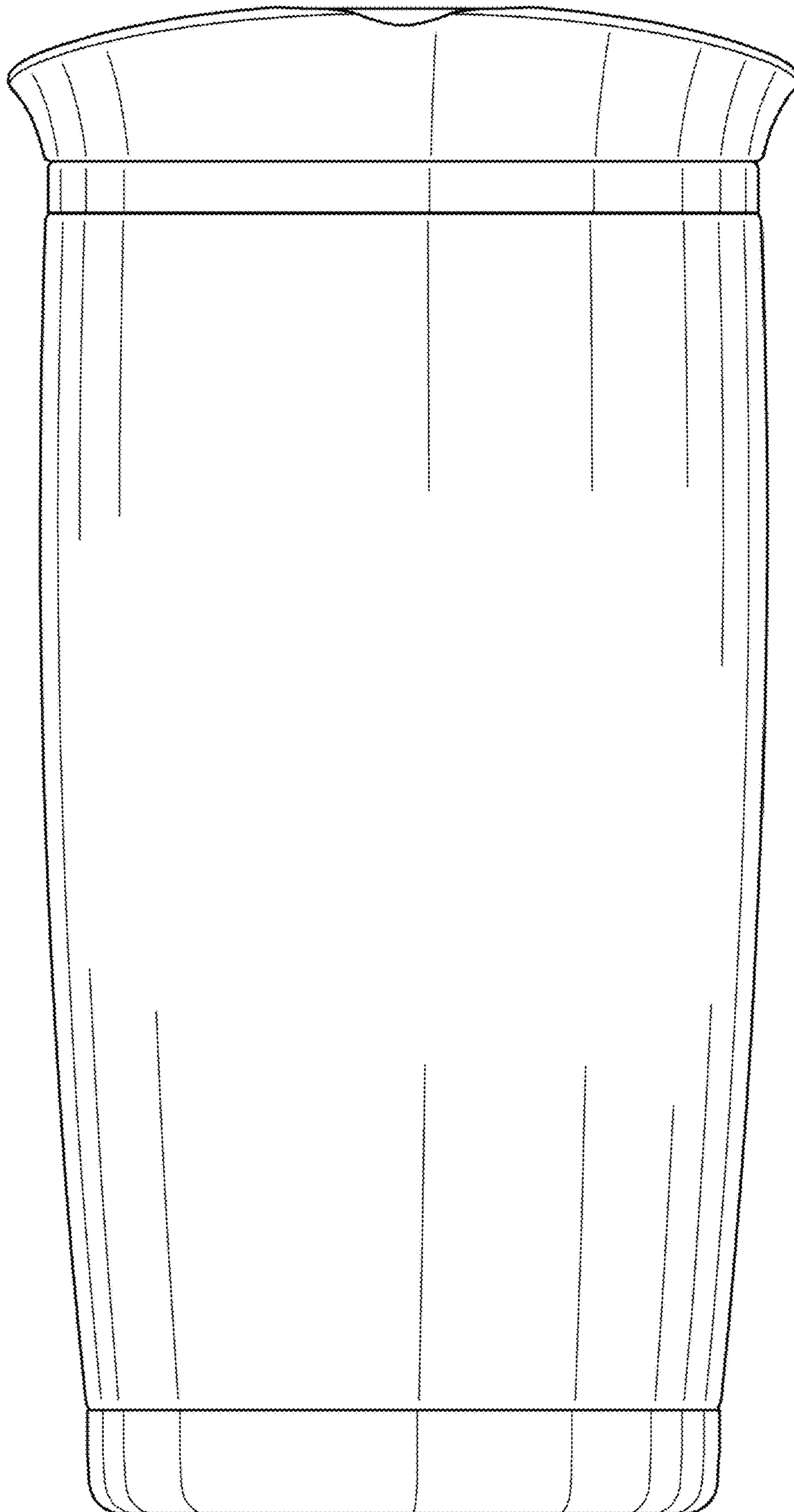

1.4

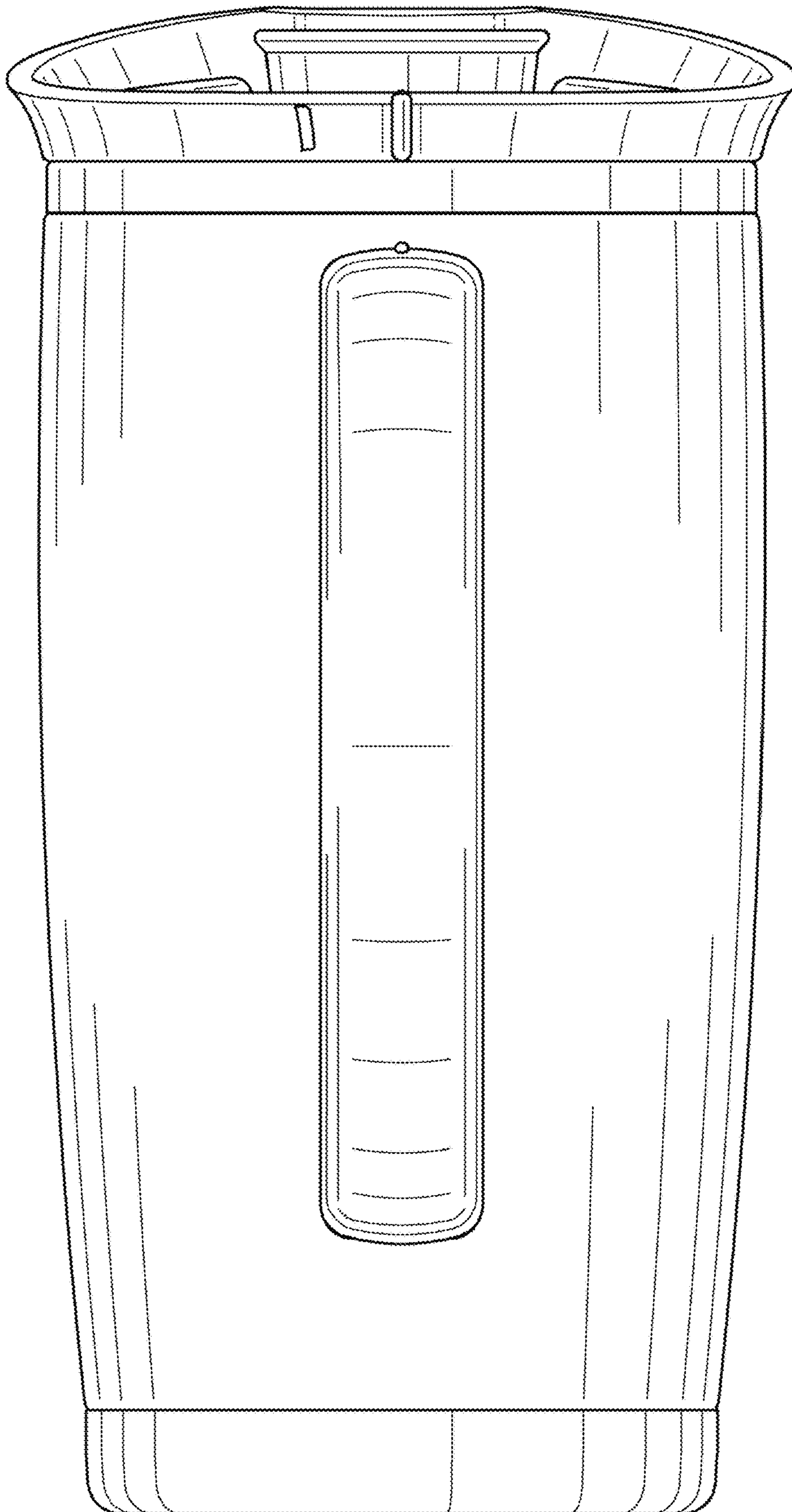

1.5

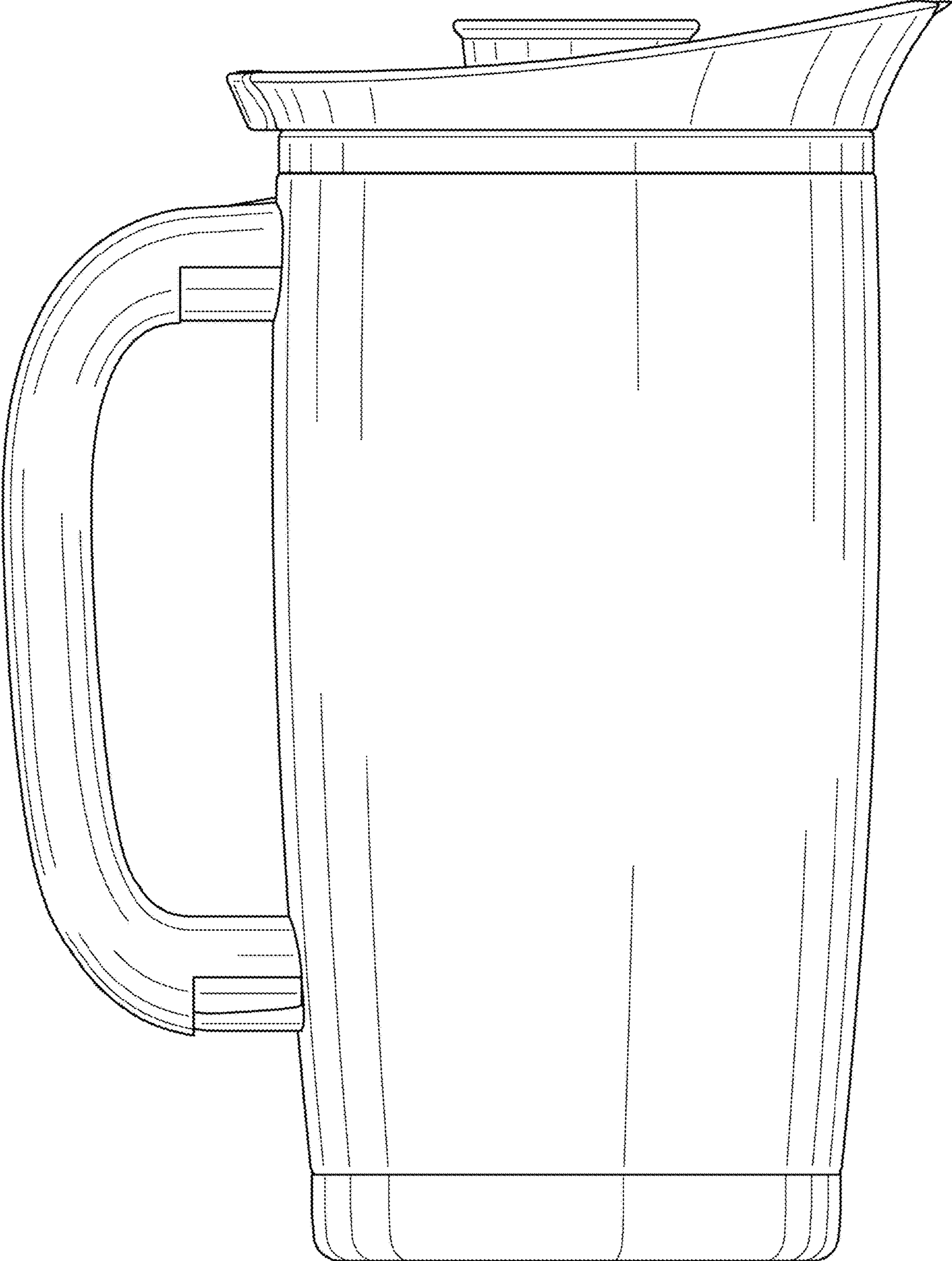

1.6

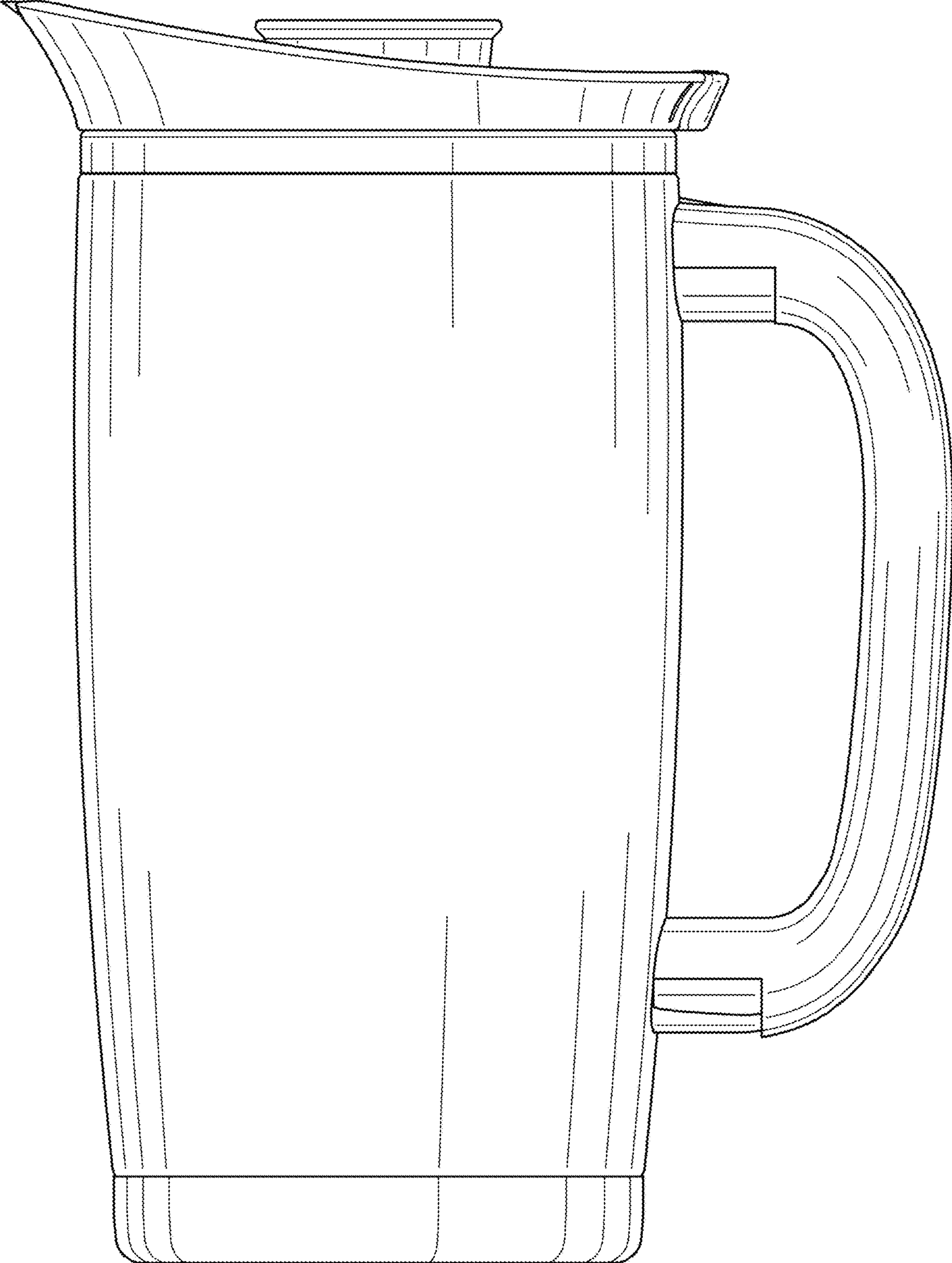

1.7

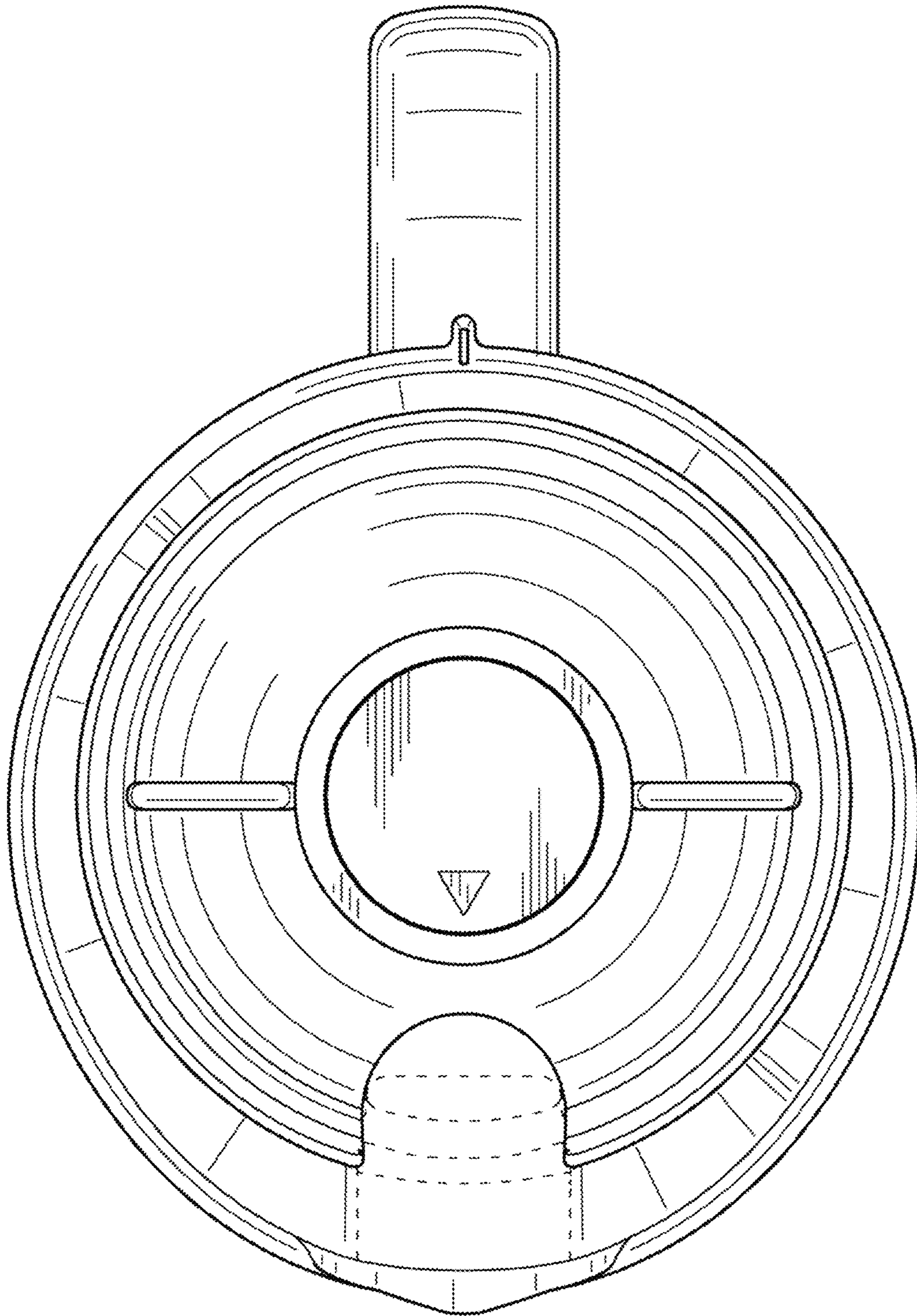

1.8

