



US00D986660S

(12) **United States Design Patent**
Tian

(10) **Patent No.:** **US D986,660 S**
(45) **Date of Patent:** **** May 23, 2023**

(54) **COFFEE TABLE**

- (71) Applicant: **HUIZHOU GREAT HARVEST WORLDWIDE INDUSTRY CO., LTD**, Huizhou (CN)
- (72) Inventor: **Xuming Tian**, Liuyang (CN)
- (73) Assignee: **HUIZHOU GREAT HARVEST WORLDWIDE INDUSTRY CO., LTD**, Huizhou (CN)
- (**) Term: **15 Years**
- (21) Appl. No.: **29/801,242**
- (22) Filed: **Jul. 28, 2021**
- (51) **LOC (14) Cl.** **06-01**
- (52) **U.S. Cl.**
USPC **D6/692.6; D6/692.1**
- (58) **Field of Classification Search**
USPC **D6/349, 686, 692, 692.1–692.6**
CPC **A47B 7/00; A47B 13/00; A47B 13/02; A47B 13/04; A47B 13/06; A47B 13/08; A47B 13/12; A47B 21/00; A47B 2200/0001; A47B 2200/0011; A47B 2200/002**
See application file for complete search history.

(56) **References Cited**

U.S. PATENT DOCUMENTS

D406,969 S	*	3/1999	Lewis	D6/692.6
D547,571 S	*	7/2007	Goldstein	D6/692.1
D552,893 S	*	10/2007	Everson	D6/692.6
D850,832 S	*	6/2019	Bieschke	D6/692.6

OTHER PUBLICATIONS

- Tufted Linen & Wood Tammy Round Ottoman/Coffee Table—La Maison Sophia <https://shop.lamaisonsophia.com/products/tammy-round-wood-and-linen-ottoman> retrieved from the internet on Mar. 6, 2023.*
- Redmond Tufted Round Cocktail Table—Our Boat House <https://www.ourboathouse.com/products/redmond-tufted-round-cocktail-table> retrieved from the internet on Mar. 6, 2023.*
- Rustic Antique Gray Solid Wood Coffee Table w/ Cushion Top—NY Furniture <https://nyfurnitureoutlets.com/products/rustic-antique-gray-solid-wood-coffee-table-w-cushion-top-and-2-end-tables-furniture-of-america-mika> retrieved from the internet on Mar. 6, 2023.*
- 24KF Large Round Upholstered Tufted Linen Ottoman Coffee Table—Amazon, first available Jun. 12, 2022 <https://www.amazon.com/dp/B0B3VTJSCV> retrieved from the internet on Mar. 6, 2023.*

* cited by examiner

Primary Examiner — Mary Ann Calabrese

(57) **CLAIM**

The ornamental design for a coffee table, as shown and described.

DESCRIPTION

FIG. 1 is a top perspective view of a coffee table showing my new design;
 FIG. 2 is a bottom perspective view thereof;
 FIG. 3 is a front elevational view thereof;
 FIG. 4 is a rear elevational view thereof;
 FIG. 5 is a left side elevational view thereof;
 FIG. 6 is a right side elevational view thereof;
 FIG. 7 is a top plan view thereof; and,
 FIG. 8 is a bottom plan view thereof.

1 Claim, 8 Drawing Sheets

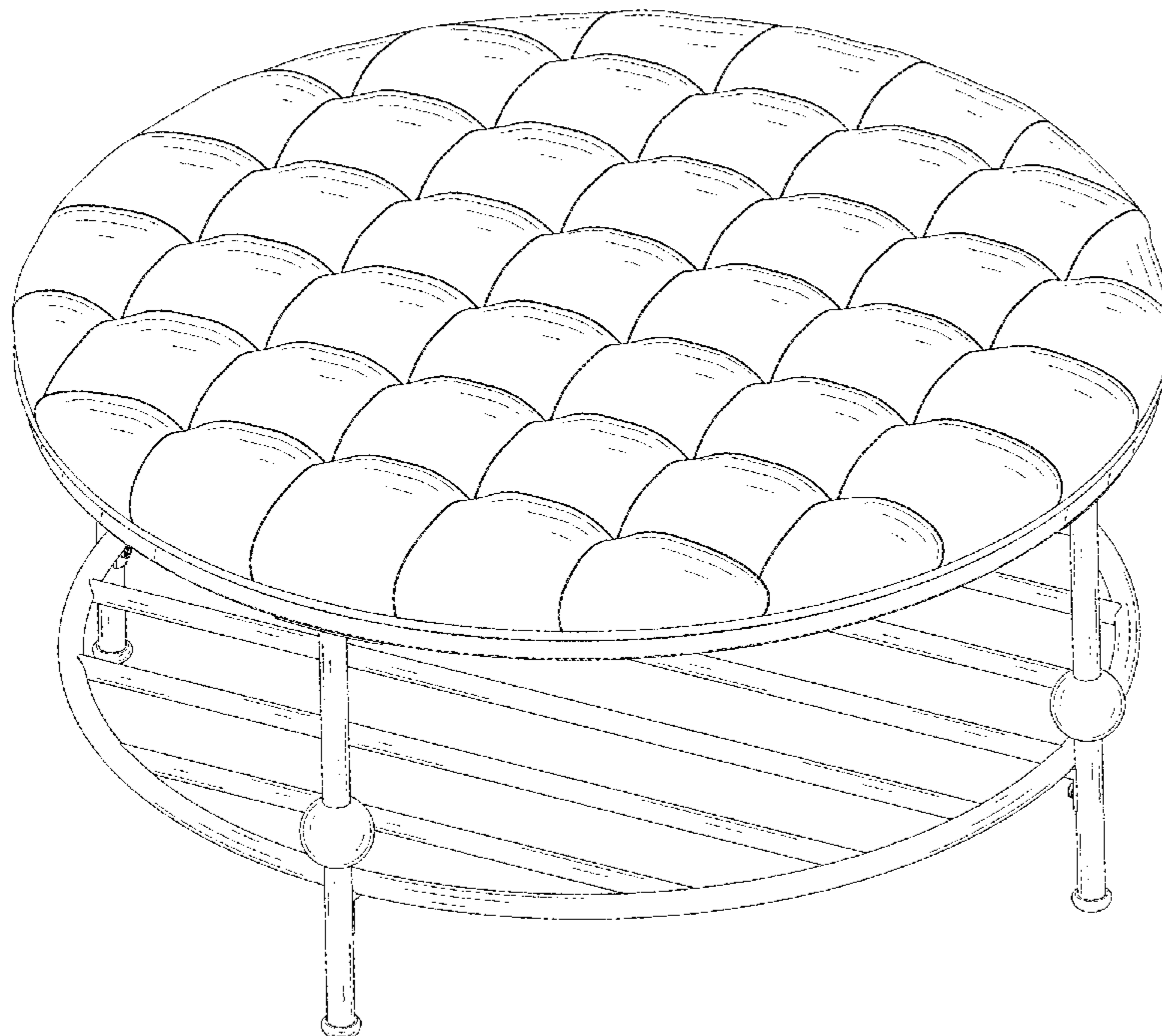

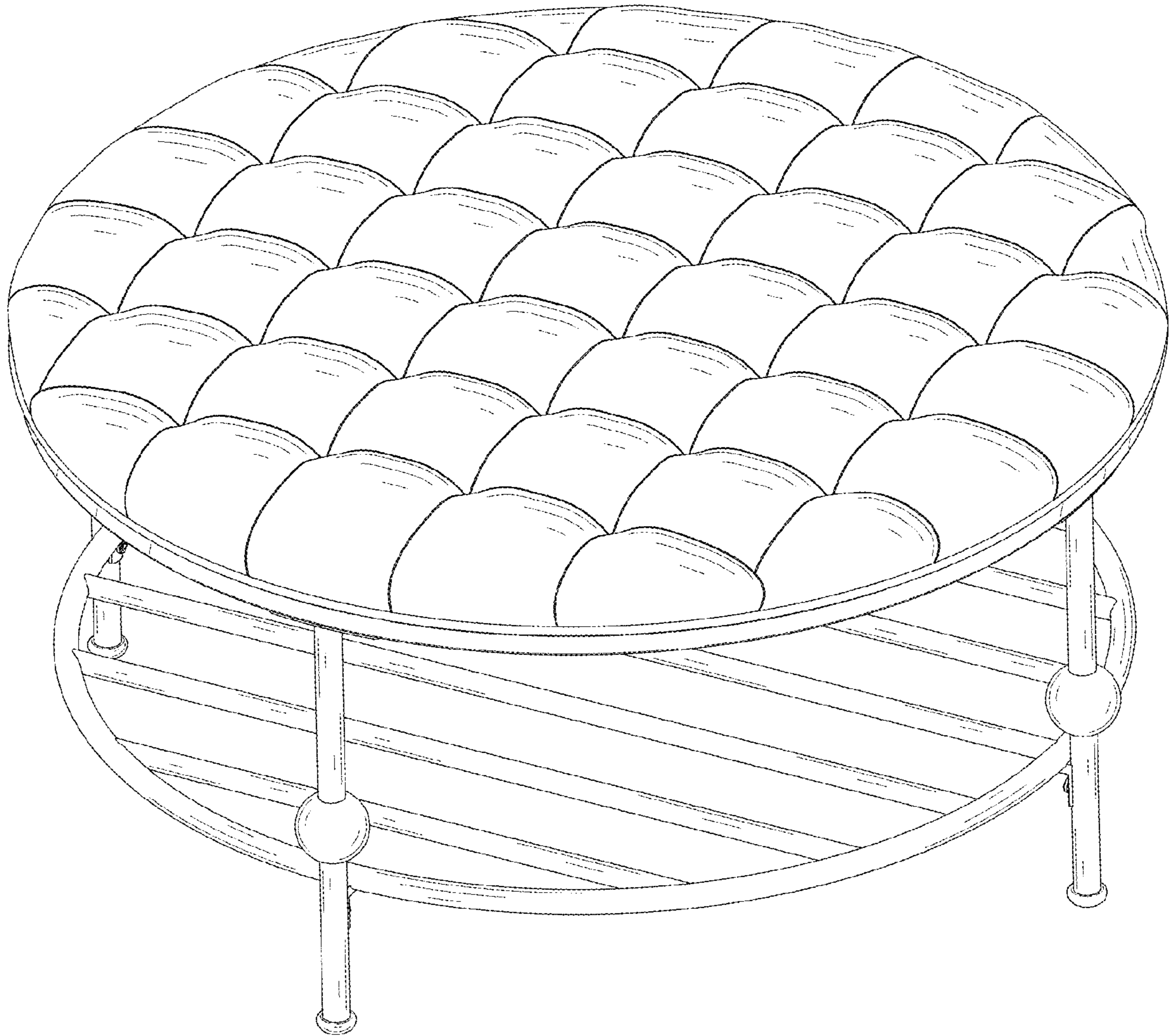

FIG. 1

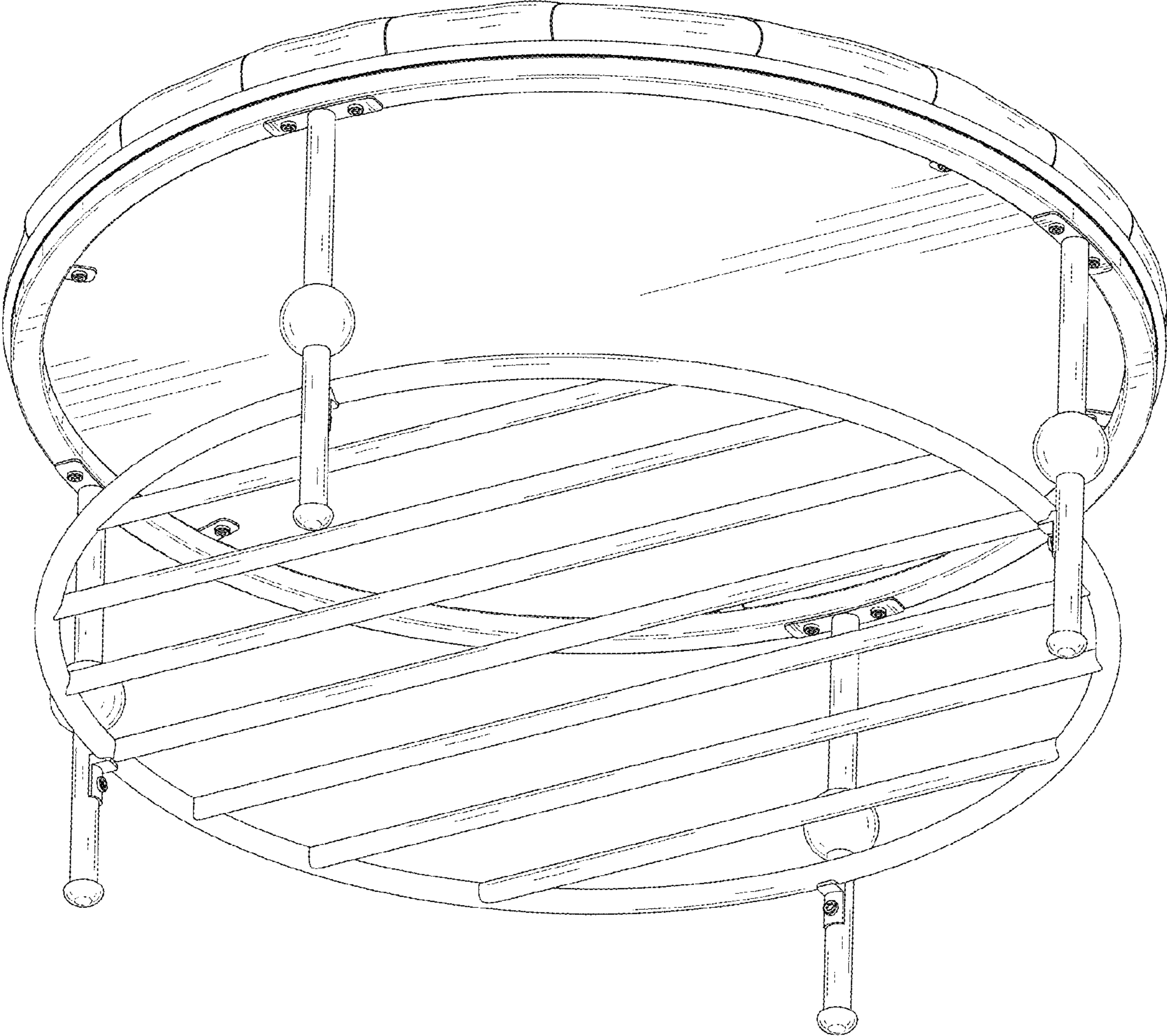

FIG. 2

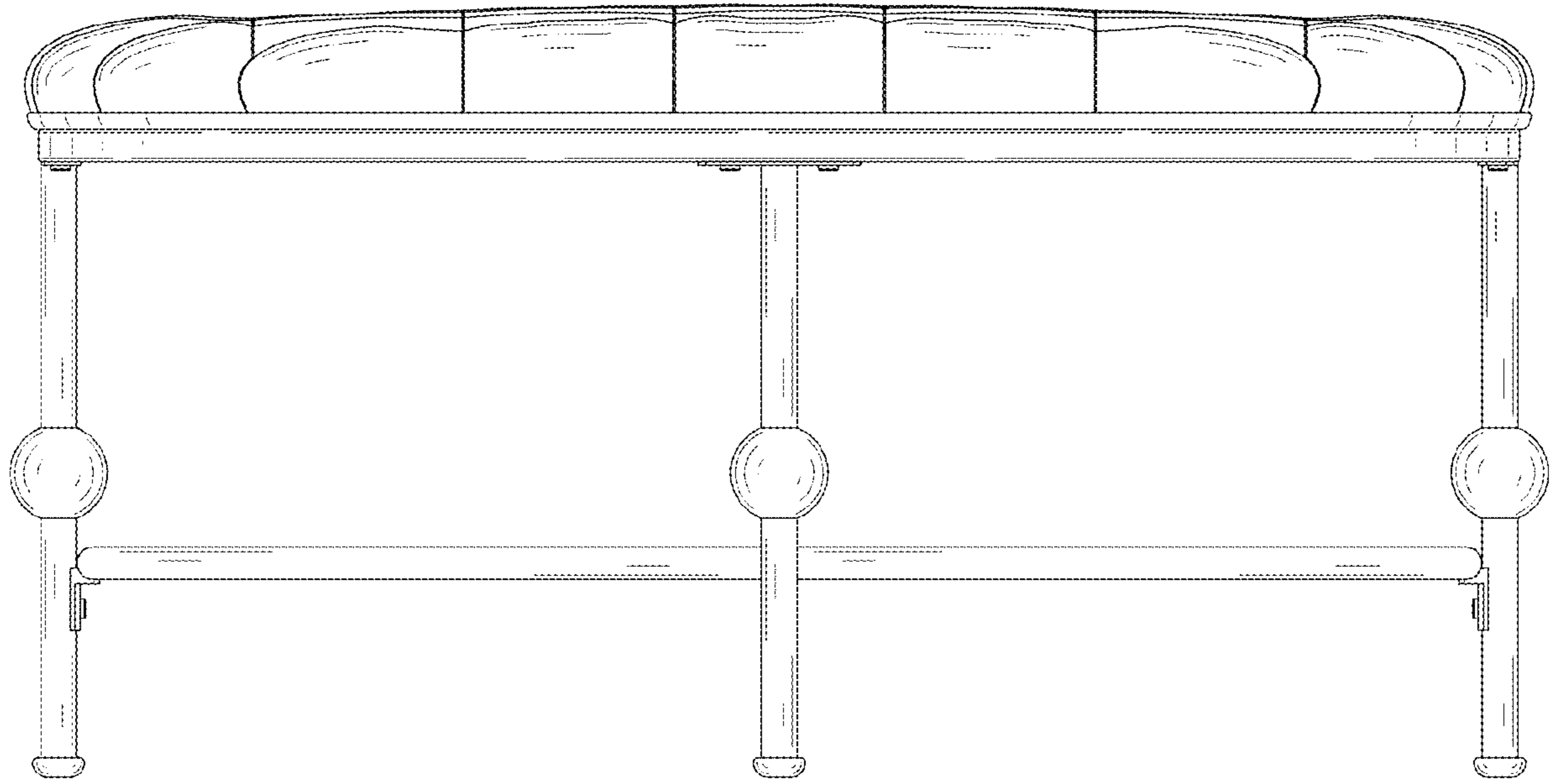

FIG. 3

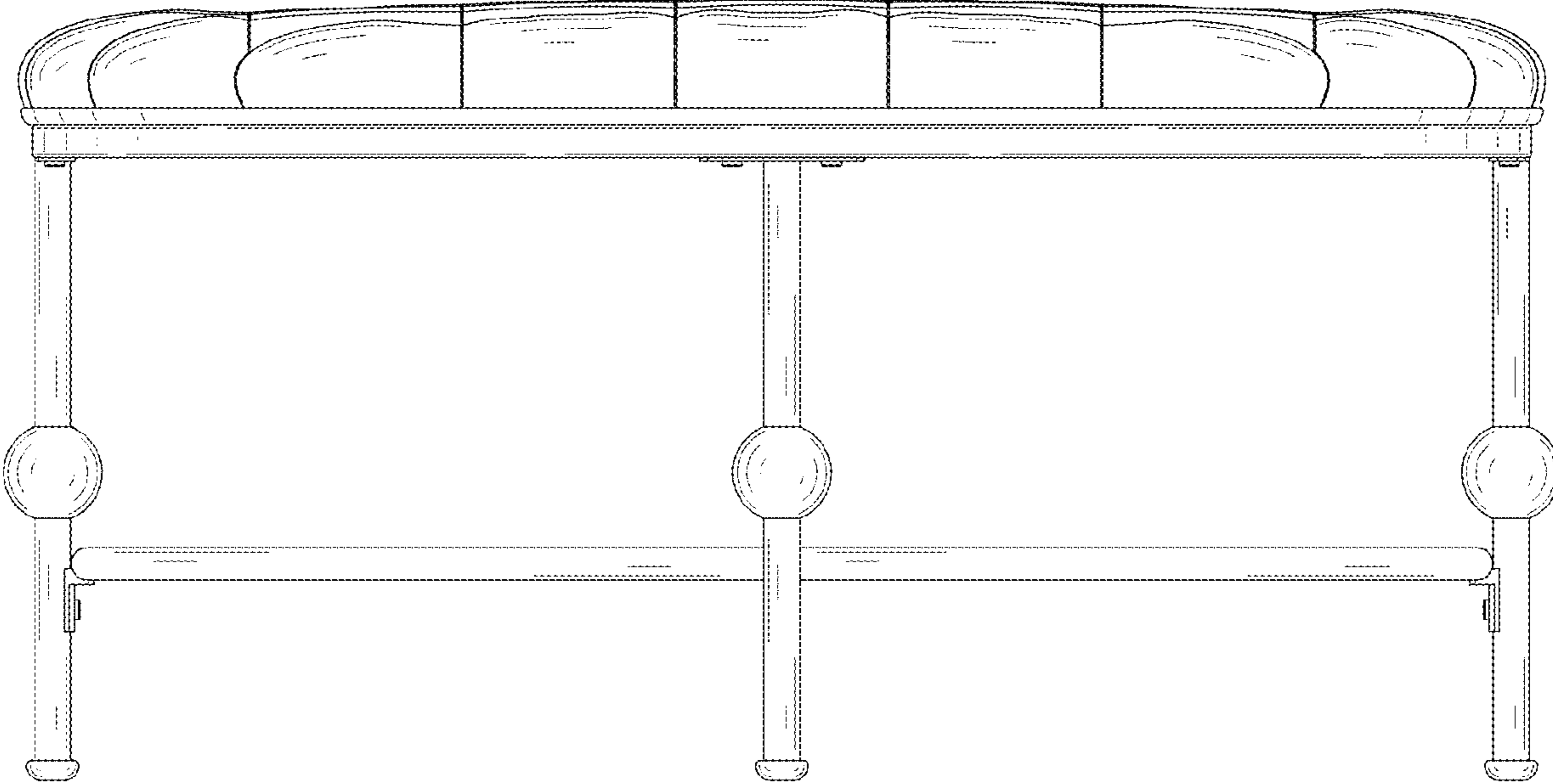

FIG. 4

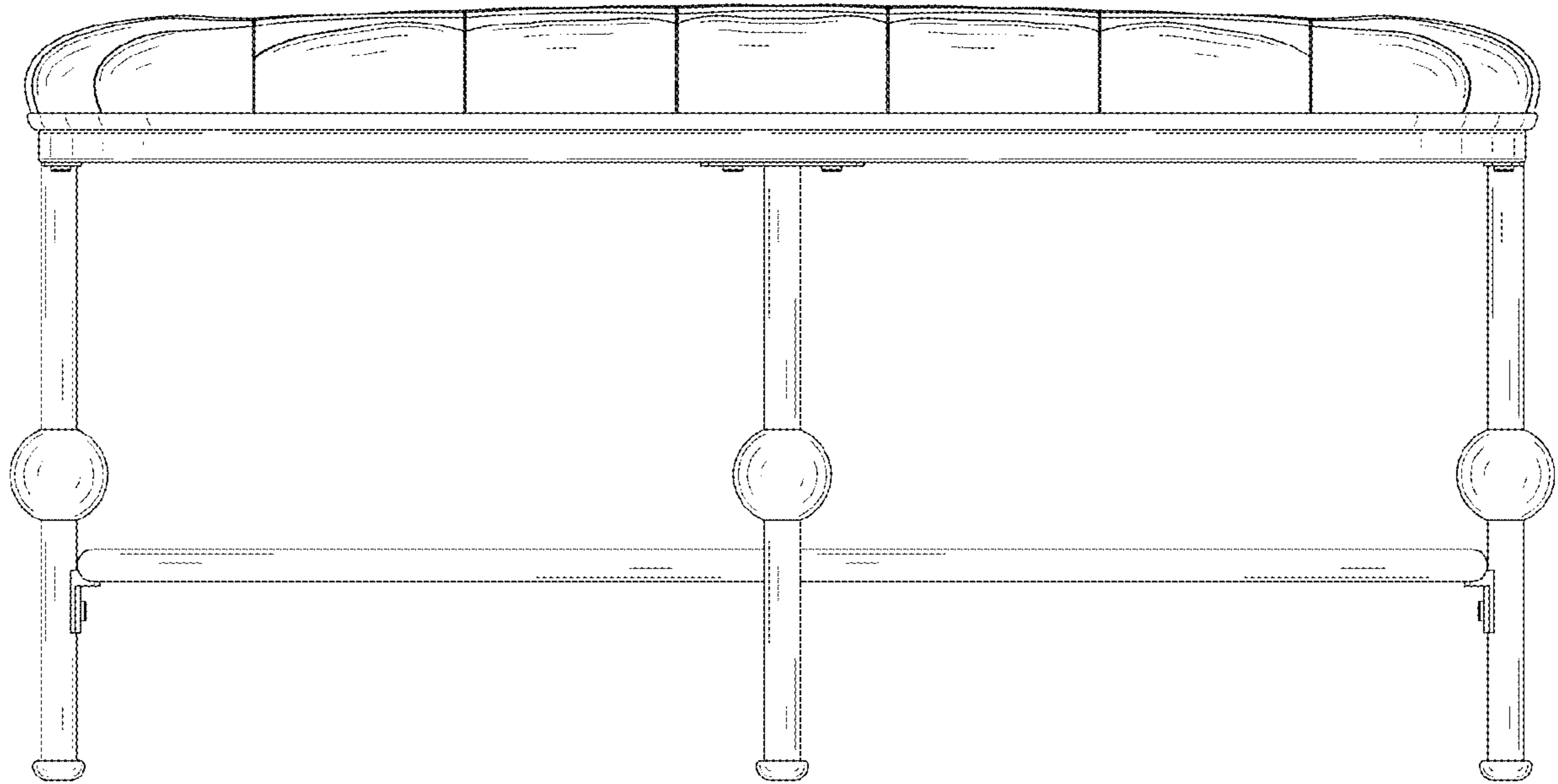

FIG. 5

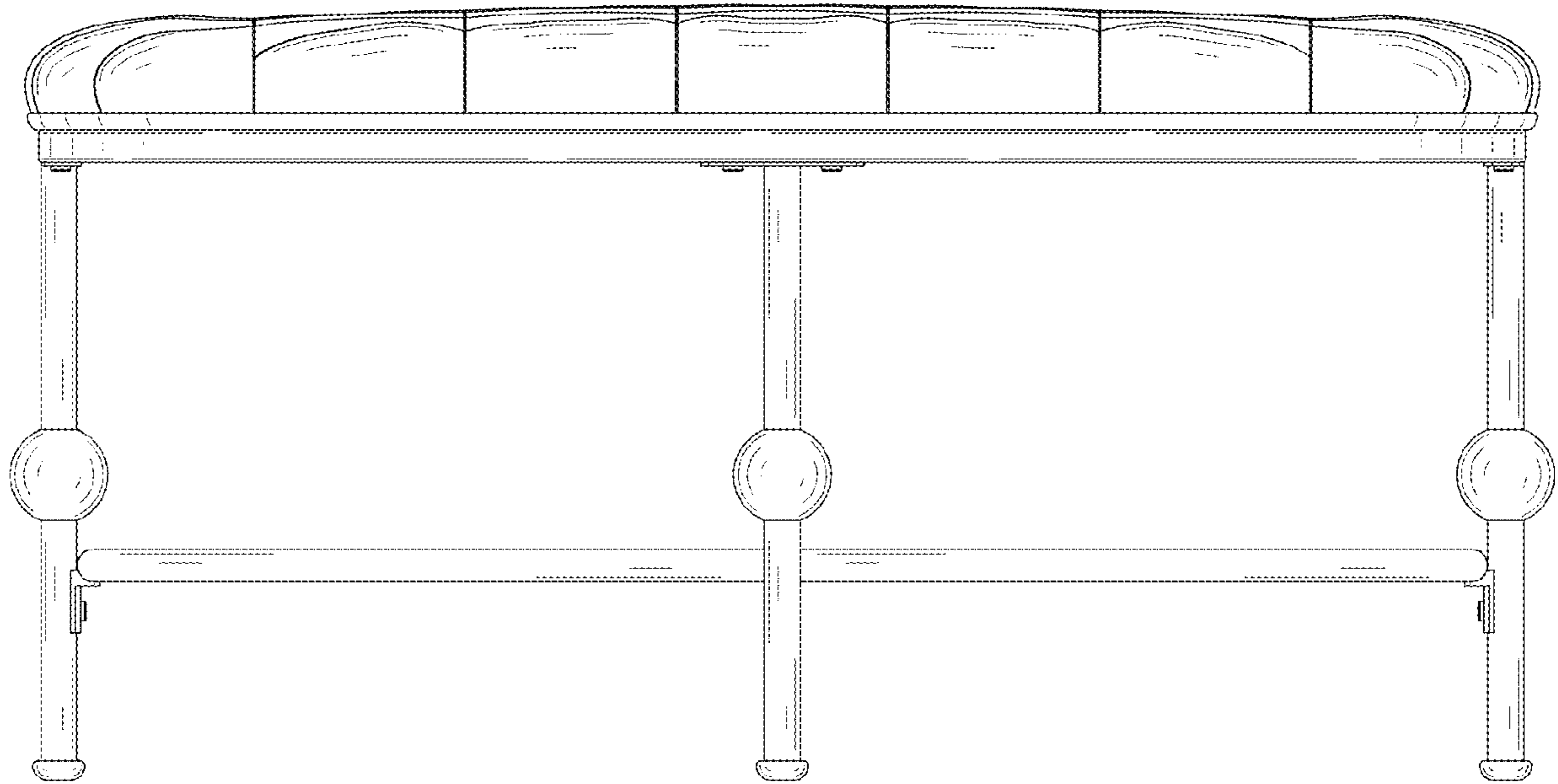

FIG. 6

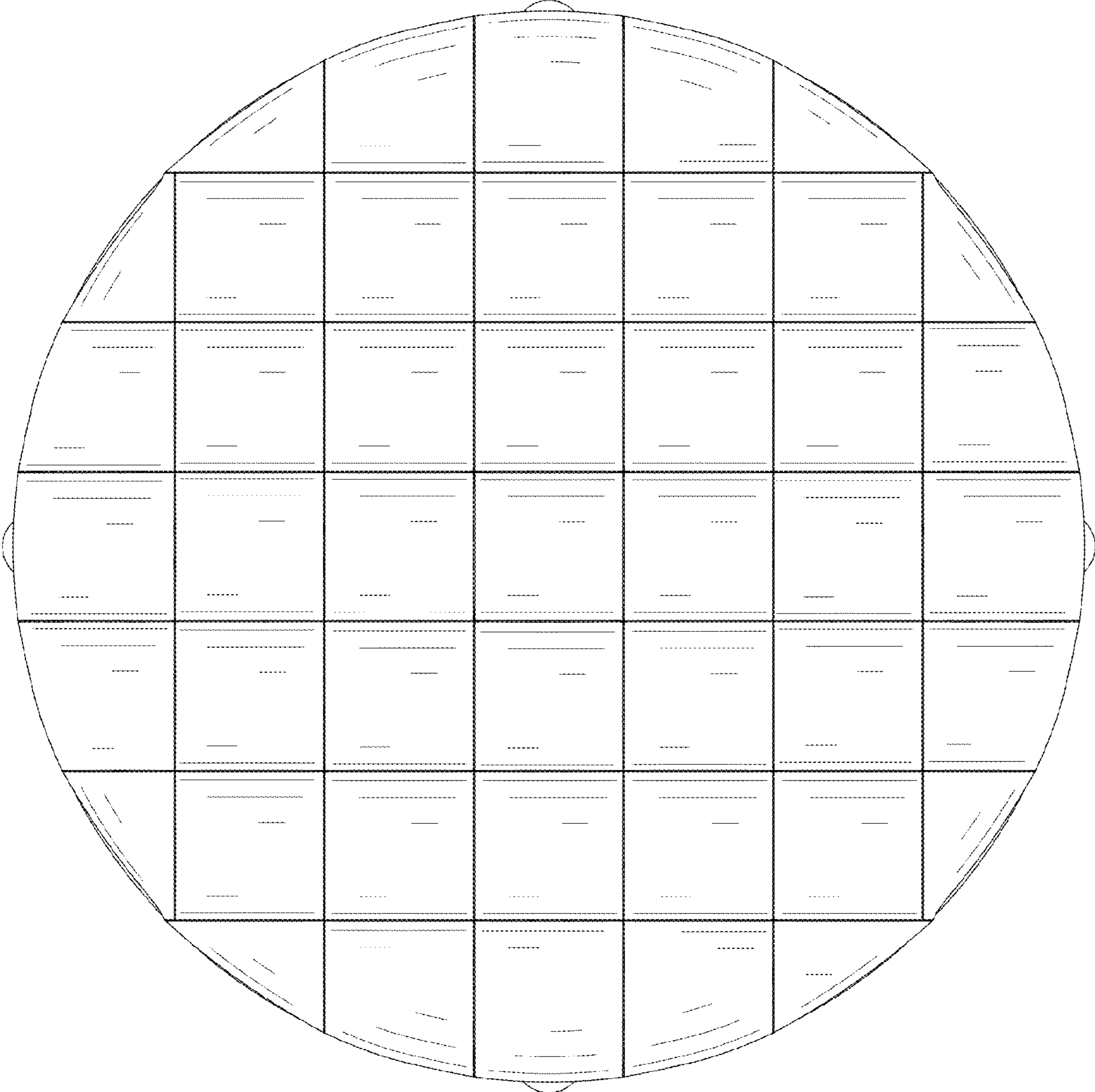

FIG. 7

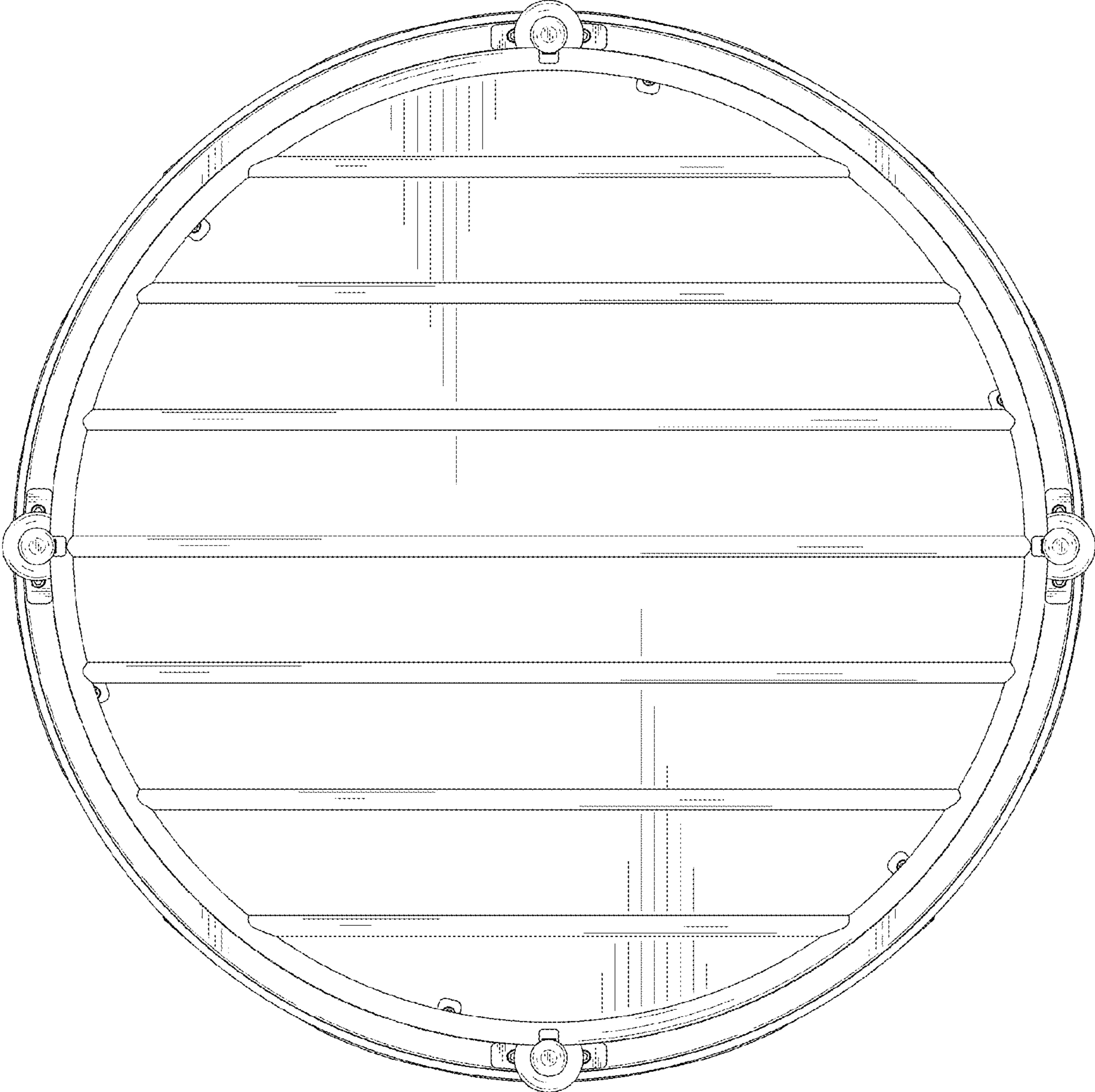

FIG. 8