



US00D986612S

(12) **United States Design Patent** (10) **Patent No.:** **US D986,612 S**  
**Vering** (45) **Date of Patent:** **\*\* May 23, 2023**

(54) **CHAISE**  
(71) Applicant: **RH US, LLC**, Corte Madera, CA (US)  
(72) Inventor: **Ann Marie Vering**, Corte Madera, CA (US)  
(73) Assignee: **RH US, LLC**, Corte Madera, CA (US)  
(\*\*) Term: **15 Years**  
(21) Appl. No.: **29/797,243**  
(22) Filed: **Jun. 29, 2021**  
(51) **LOC (14) Cl.** ..... **06-01**  
(52) **U.S. Cl.**  
USPC ..... **D6/361**  
(58) **Field of Classification Search**  
USPC ..... D6/357, 360, 361, 365, 367, 368, 369,  
D6/370, 381, 382, 383, 604  
CPC .. A47C 1/02; A47C 1/028; A47C 4/54; A47C  
17/64; A47C 17/86; A47C 23/047  
See application file for complete search history.

(56) **References Cited**

**U.S. PATENT DOCUMENTS**

D646,067 S *	10/2011	Frnier	.....	D6/361
D650,602 S *	12/2011	Massaud	.....	D6/361
D657,969 S *	4/2012	Nguyen	.....	D6/369
D707,049 S *	6/2014	Asner	.....	D6/361
D880,882 S *	4/2020	Ho	.....	D6/361
D891,801 S *	8/2020	Aubry	.....	D6/361
D957,836 S *	7/2022	Ranco	.....	D6/361
D957,837 S *	7/2022	Ranco	.....	D6/361
D958,556 S *	7/2022	Esteve Cambra	.....	D6/361
D960,595 S *	8/2022	Esteve Cambra	.....	D6/361
D974,063 S *	1/2023	Ranco	.....	D6/361

**OTHER PUBLICATIONS**

Laurel Aluminum Chaise, available in rh.com, site visited on Feb. 23, 2023, URL:https://rh.com/catalog/product/product.jsp?productId=prod23130717&sale=false&layout=horizontal (Year: 2023).\*

Modway Perspective Aluminum Outdoor Patio Chaise, available in Amazon.com, first available date of Dec. 20, 2018, site visited on Feb. 16, 2023, URL:https://www.amazon.com/Modway-EEI-3301-WHI-CHA-Perspective-Cushion-Charcoal/dp/B07M8P1TJT?th=1 (Year: 2018).\*

The Sun Lounger, available in hineighbor.com, site visited on Feb. 16, 2023, URL:https://www.hineighbor.com/products/teak-sun-lounger?variant=39762086920272&currency=USD&g\_network=x&g\_productchannel=online&g\_adid=& . . . (Year: 2023).\*

\* cited by examiner

*Primary Examiner* — Mary Ann Calabrese

*Assistant Examiner* — Mark David Wolfley

(74) *Attorney, Agent, or Firm* — Lewis Roca Rothgerber Christie LLP

(57) **CLAIM**

The ornamental design for a chaise, as shown and described.

**DESCRIPTION**

FIG. 1 is a front right perspective view of a chaise showing my new design;

FIG. 2 is a left rear perspective view thereof;

FIG. 3 is a top plan view thereof;

FIG. 4 is a right side elevation view thereof, the left side elevation view being a mirror image;

FIG. 5 is a front elevation view thereof;

FIG. 6 is a rear elevation view thereof; and,

FIG. 7 is a front right side perspective view thereof showing the chaise in a reclined position.

The broken lines represent environmental subject matter and portions of the chaise that form no part of the claimed design.

**1 Claim, 6 Drawing Sheets**

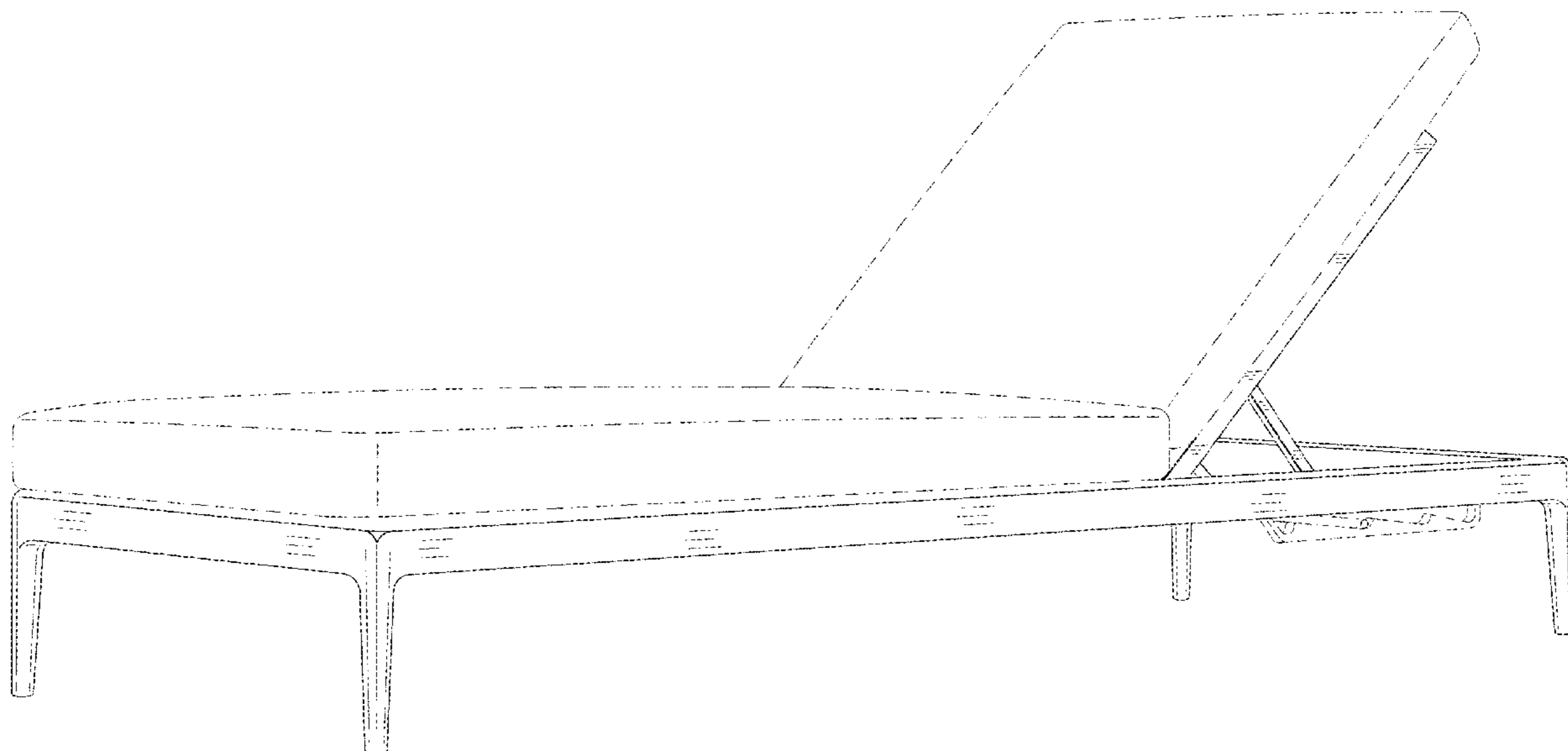

FIG. 1

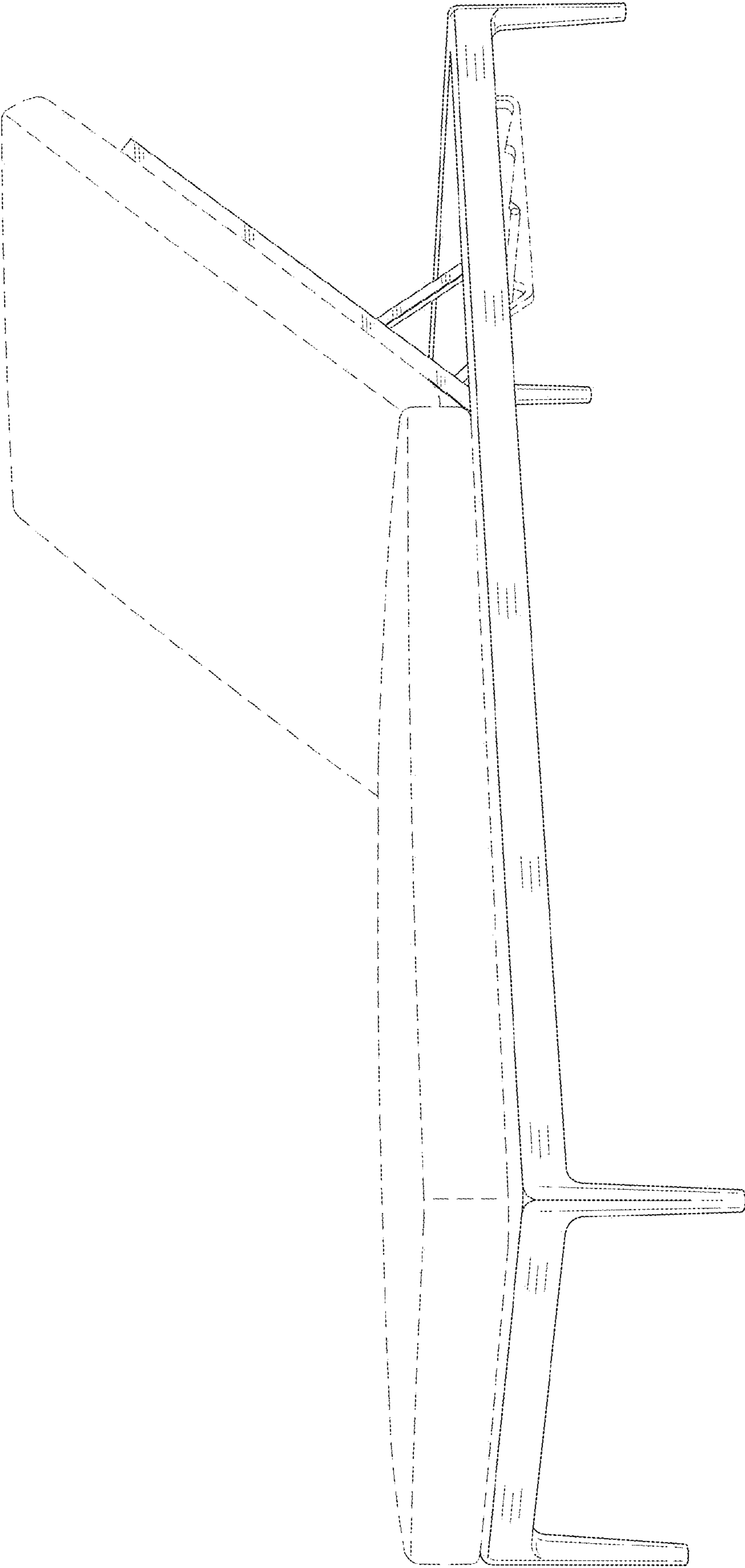

FIG. 2

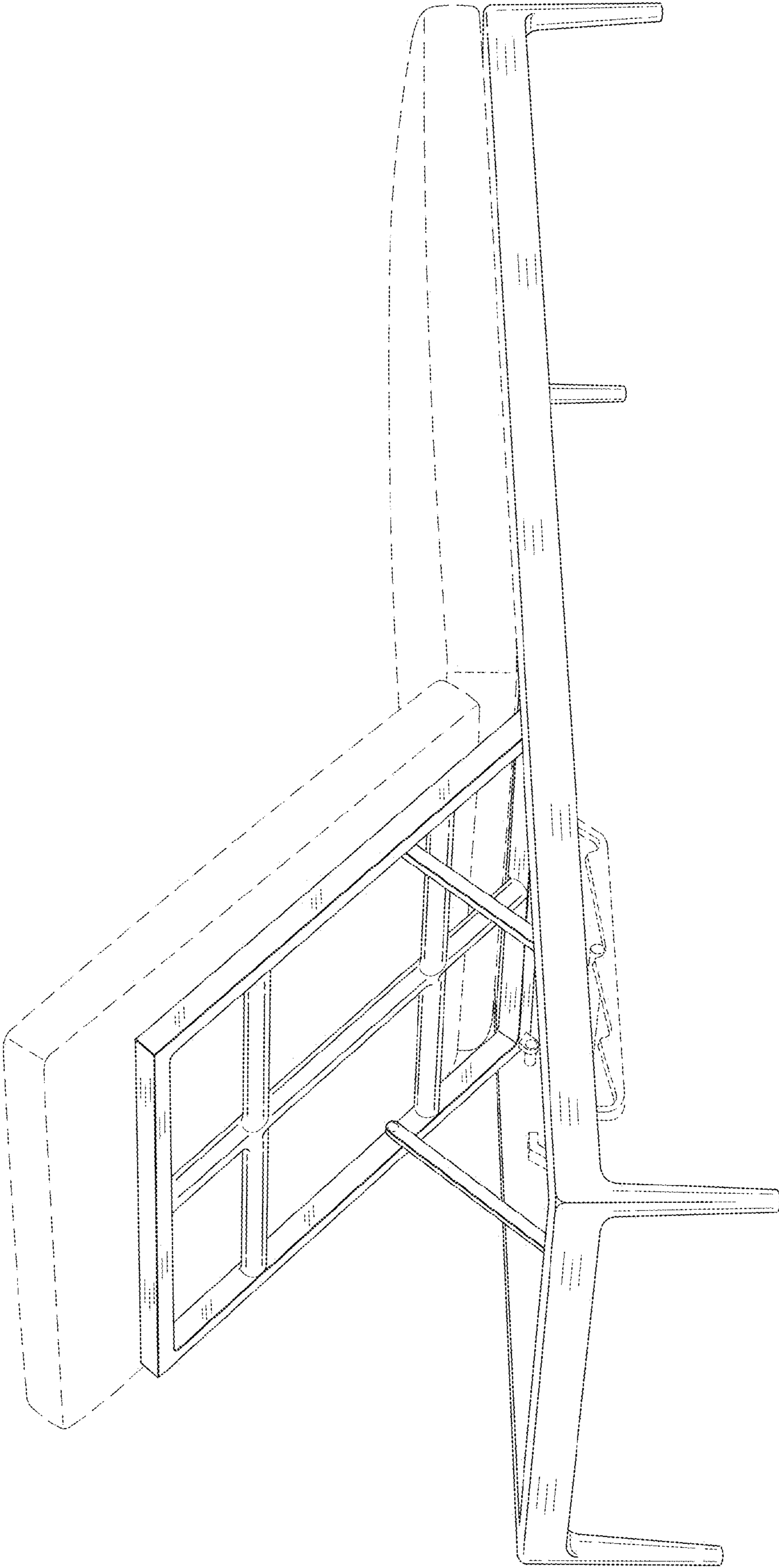

FIG. 3

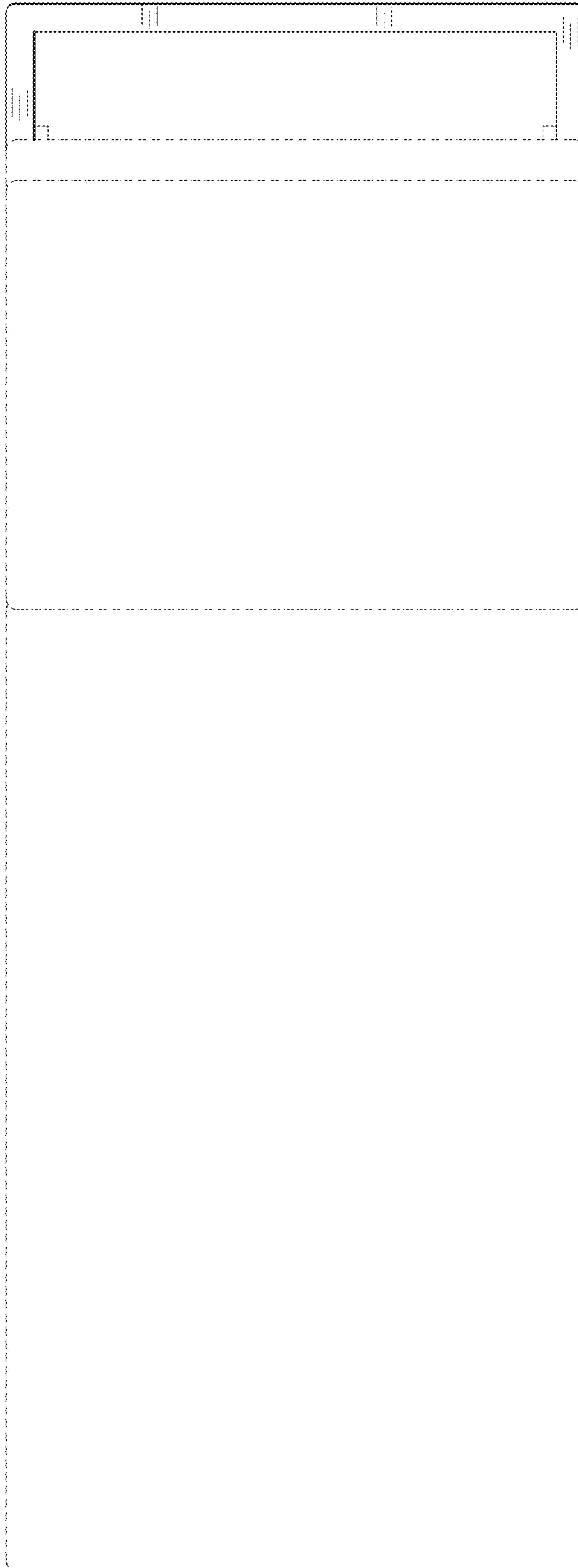

FIG. 4

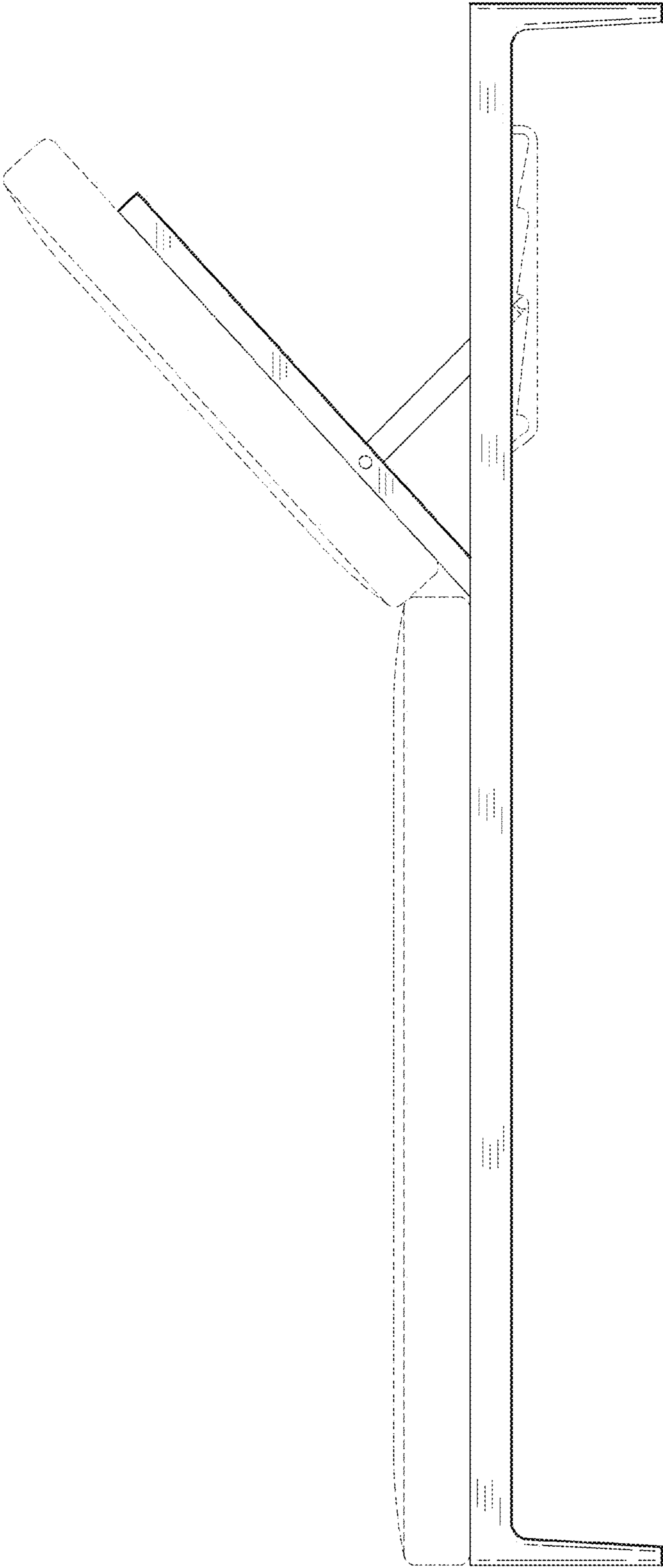

FIG. 6

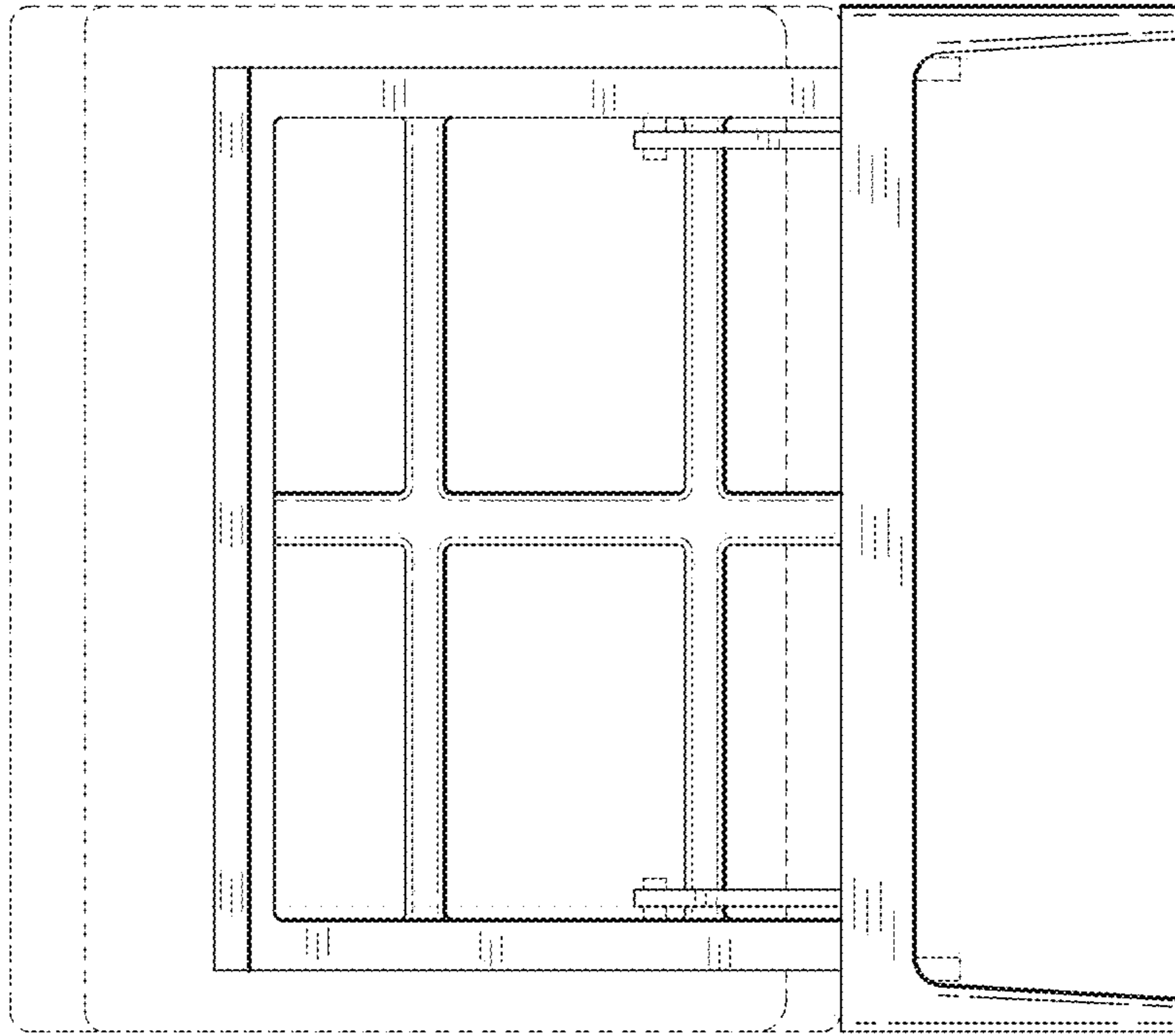

FIG. 5

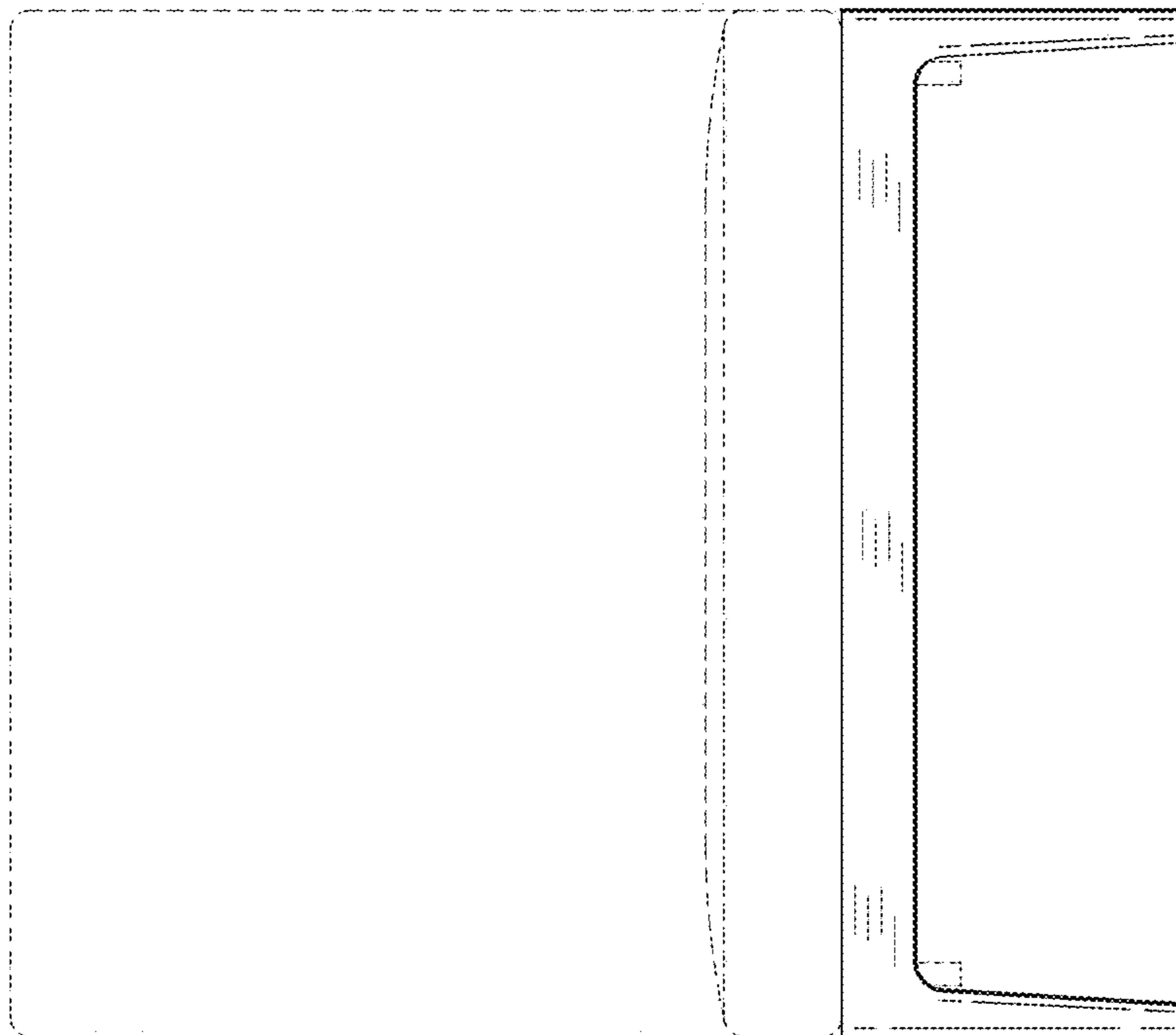

FIG. 7

