



US00D986591S

(12) **United States Design Patent**  
**Geddes**

(10) **Patent No.:** **US D986,591 S**

(45) **Date of Patent:** **\*\* May 23, 2023**

(54) **BAG**

(71) Applicant: **GIVENCHY**, Paris (FR)

(72) Inventor: **Laura Geddes**, Paris (FR)

(73) Assignee: **GIVENCHY**, Paris (FR)

(\*\*) Term: **15 Years**

(21) Appl. No.: **29/770,341**

(22) Filed: **Feb. 11, 2021**

(30) **Foreign Application Priority Data**

Oct. 3, 2020 (EM) ..... 008194005-0004

(51) **LOC (14) Cl.** ..... **03-01**

(52) **U.S. Cl.**  
USPC ..... **D3/232; D3/217**

(58) **Field of Classification Search**  
USPC ..... D3/215-217, 226, 232-234, 237-238,  
D3/243, 245-246, 301  
CPC ..... A45F 3/02; A45F 3/04; A45F 2003/002;  
A45C 11/20; A45C 3/00; A45C 9/00;  
A45C 1/02  
See application file for complete search history.

(56) **References Cited**

**U.S. PATENT DOCUMENTS**

D170,080 S \* 7/1953 Codish ..... D3/232  
D324,978 S \* 3/1992 Rosson ..... D7/709  
D404,563 S \* 1/1999 Rausch ..... D3/216  
D415,612 S \* 10/1999 Mach ..... D3/246  
D516,813 S \* 3/2006 Tortorella ..... D3/301

D527,177 S \* 8/2006 Pillet ..... D3/246  
D704,436 S \* 5/2014 Hickman ..... D3/231  
D774,299 S \* 12/2016 Anderson ..... D3/232  
D790,850 S \* 7/2017 Baldwin ..... D3/226  
D833,736 S \* 11/2018 Voll ..... D3/217  
D869,153 S \* 12/2019 Sun ..... D3/232  
D887,128 S \* 6/2020 Novak ..... D3/217  
D974,747 S \* 1/2023 He ..... A45F 3/04  
D3/217  
2009/0050246 A1 \* 2/2009 Godshaw ..... A45F 3/02  
150/108

\* cited by examiner

*Primary Examiner* — Jennifer L Watkins

*Assistant Examiner* — Samantha Lynne Brodowski

(74) *Attorney, Agent, or Firm* — Cantor Colburn LLP

(57) **CLAIM**

I claim, the ornamental design for a bag, as shown and described.

**DESCRIPTION**

FIG. 1 is a perspective view of a bag, showing my new design;  
FIG. 2 is a front view thereof;  
FIG. 3 is a rear view thereof;  
FIG. 4 is a side view thereof;  
FIG. 5 is an opposite side view thereof;  
FIG. 6 is a top view thereof; and,  
FIG. 7 is a bottom view thereof.  
The connected dashed lines used in the drawings indicate stitching and form a part of the claimed design.

**1 Claim, 5 Drawing Sheets**

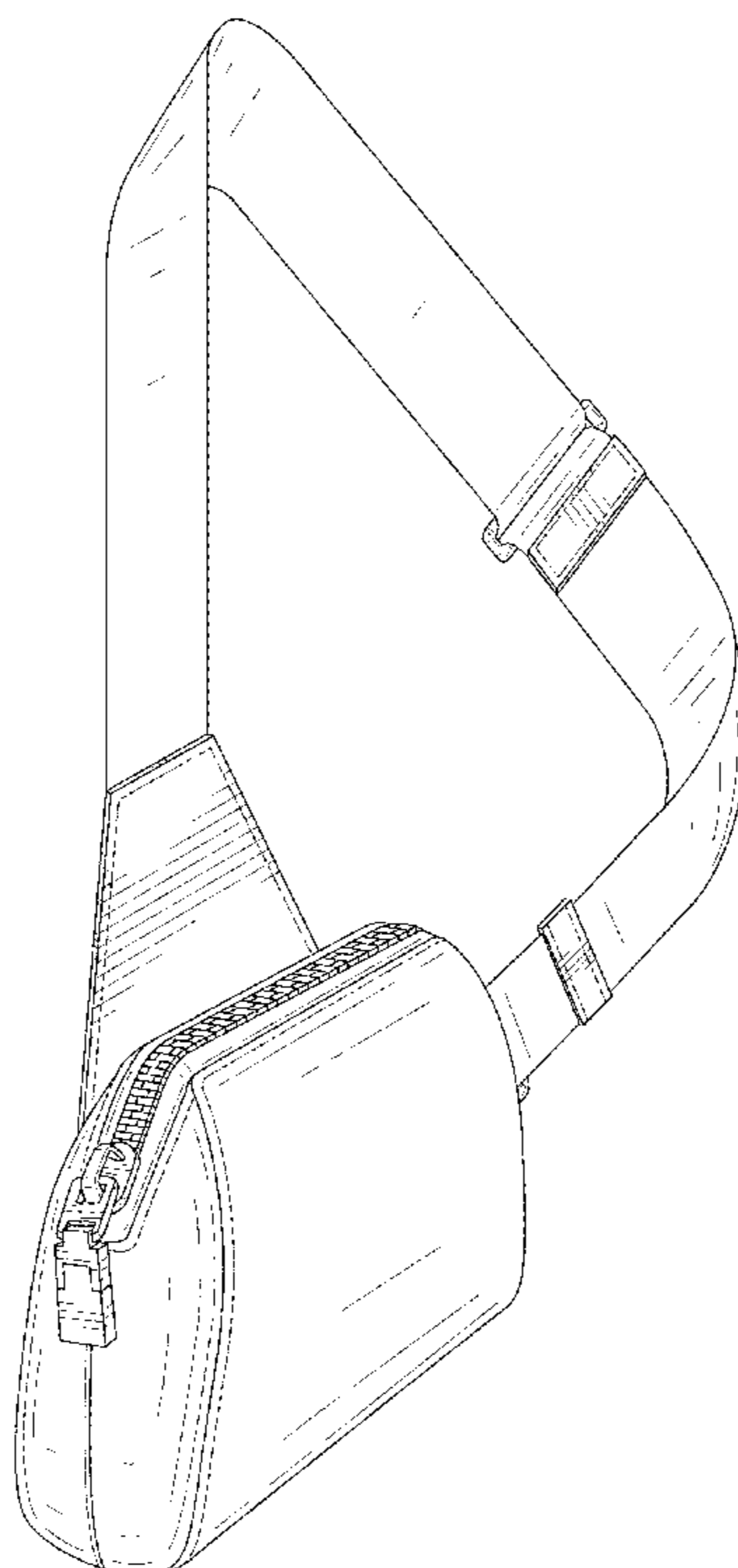

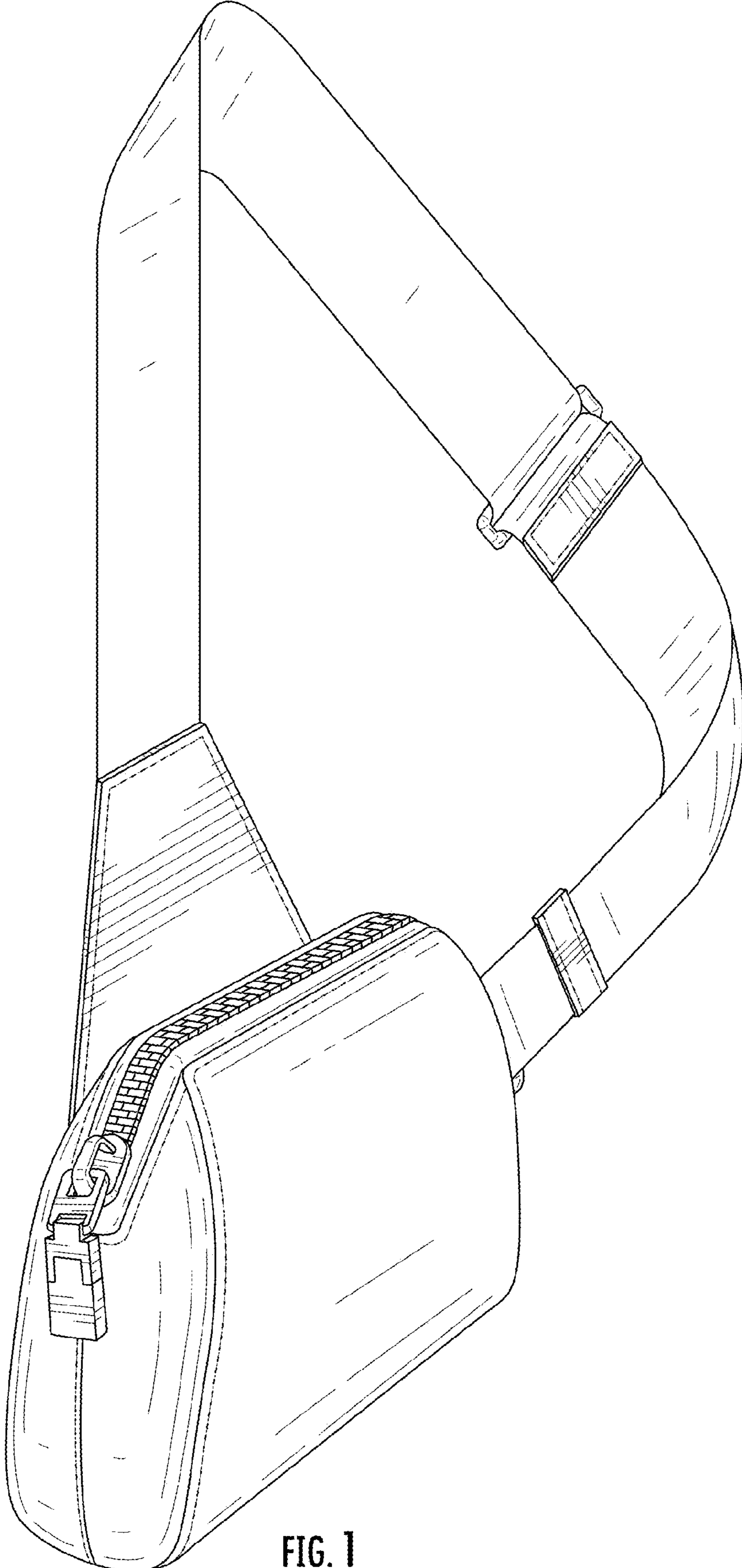

FIG. 1

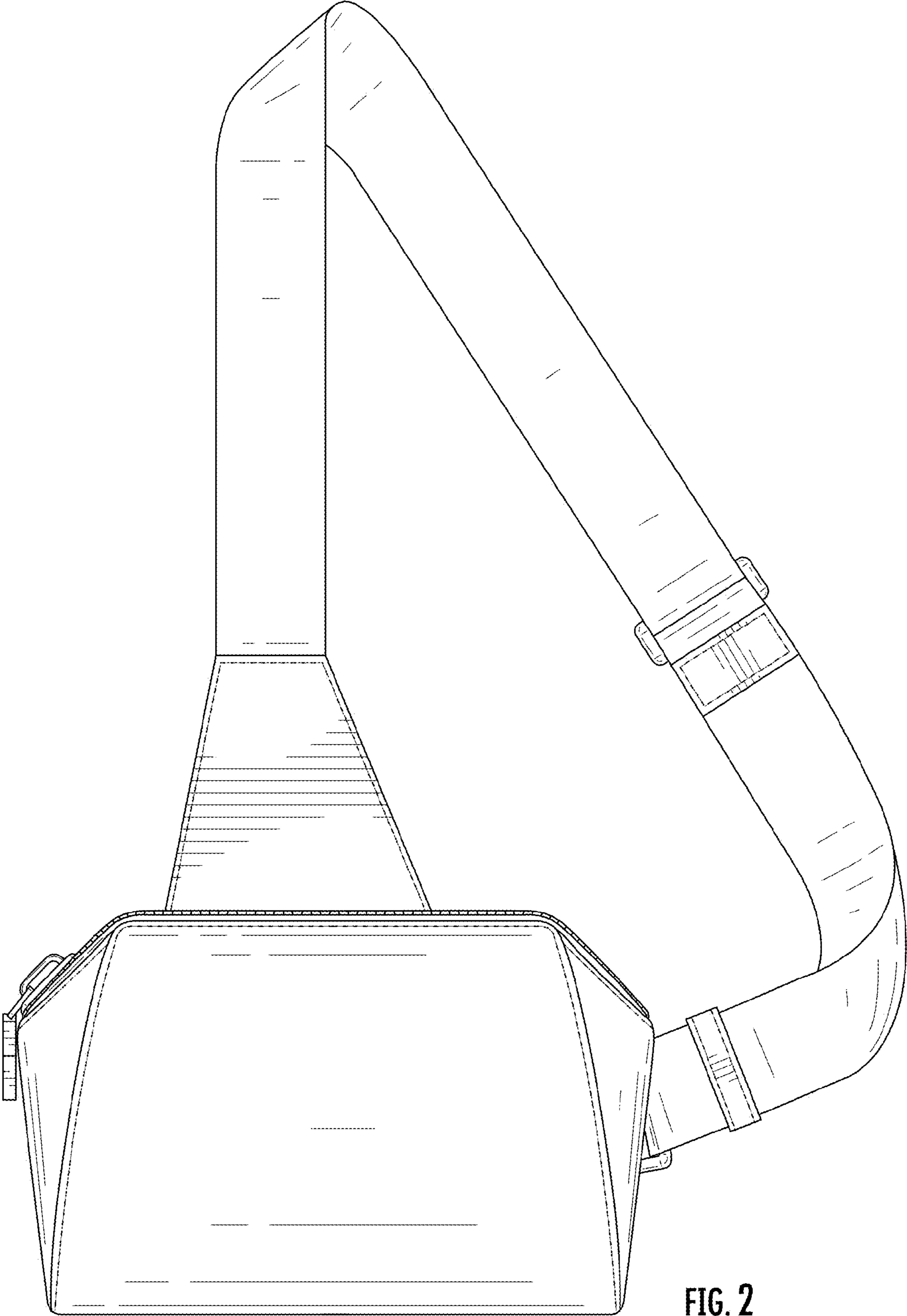

FIG. 2

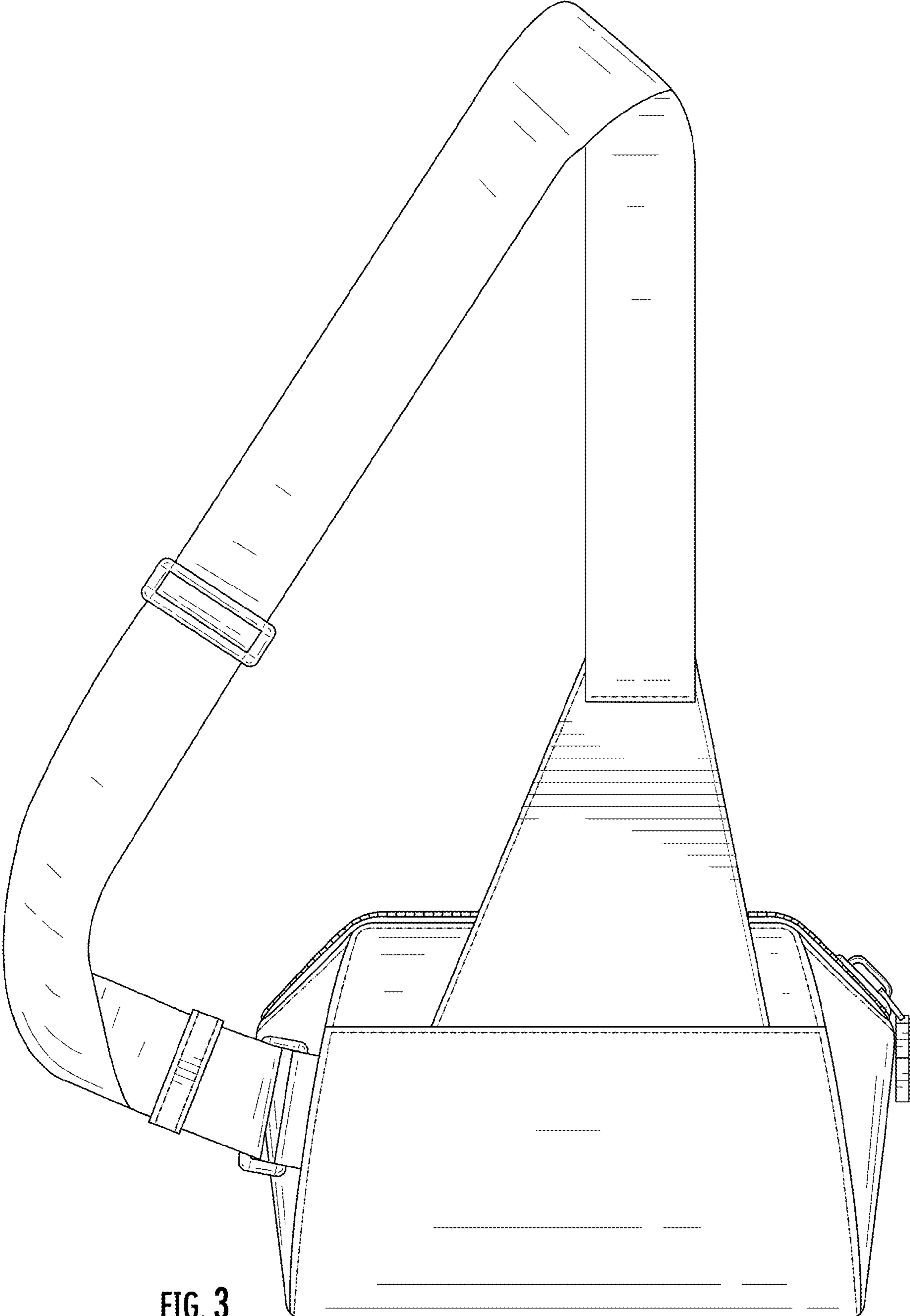
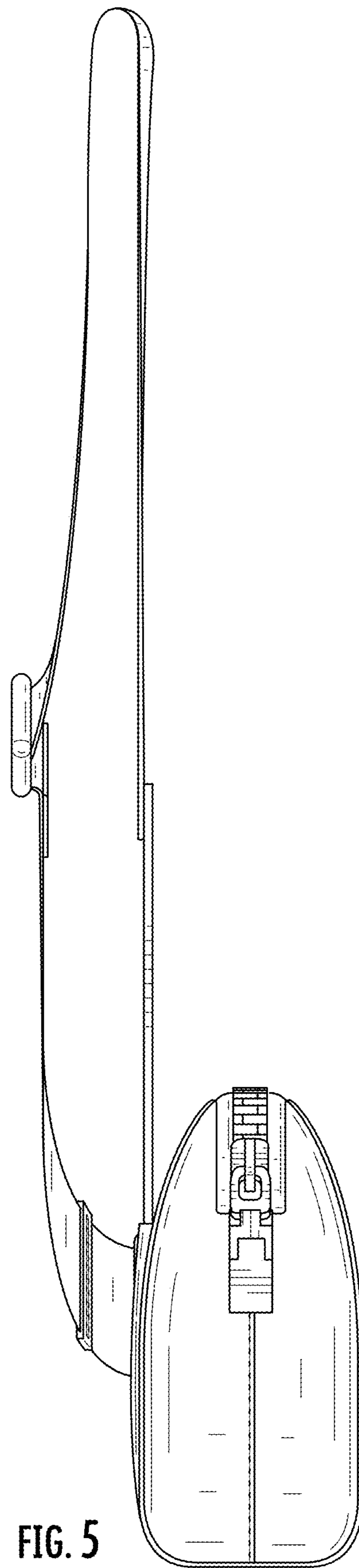
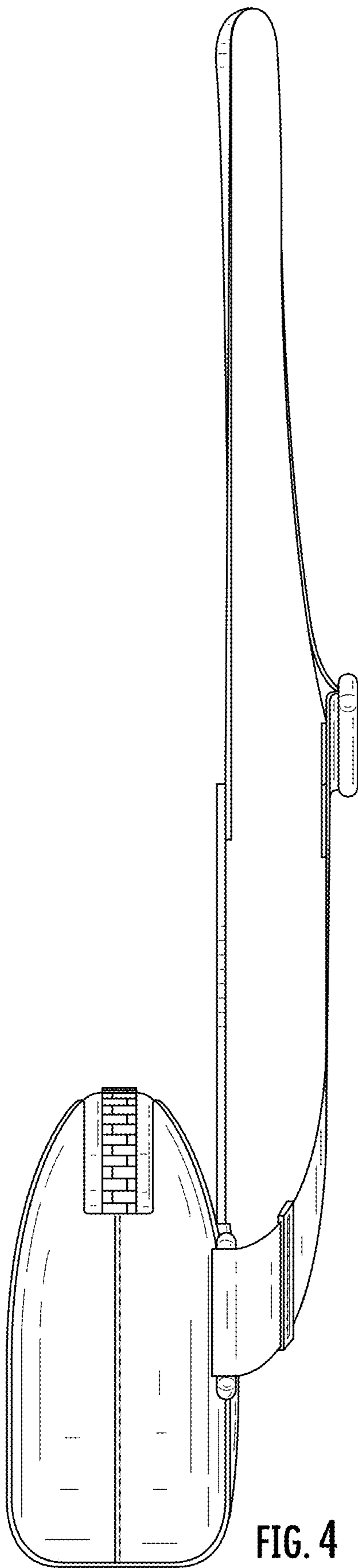

FIG. 3





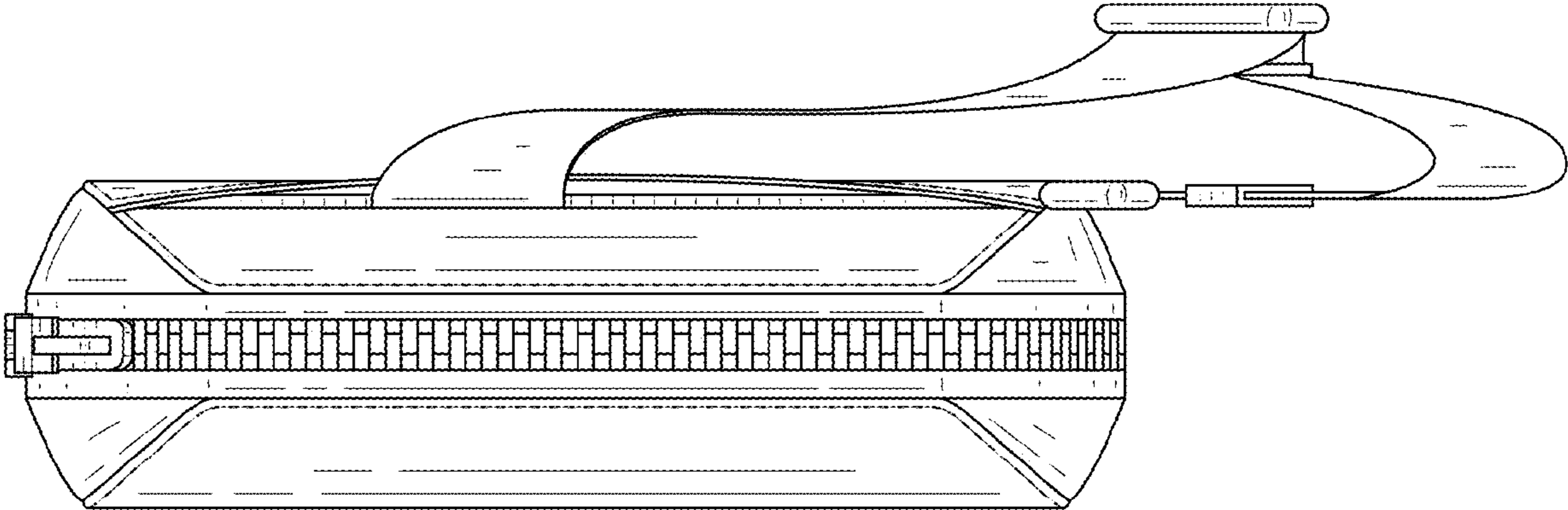

FIG. 6

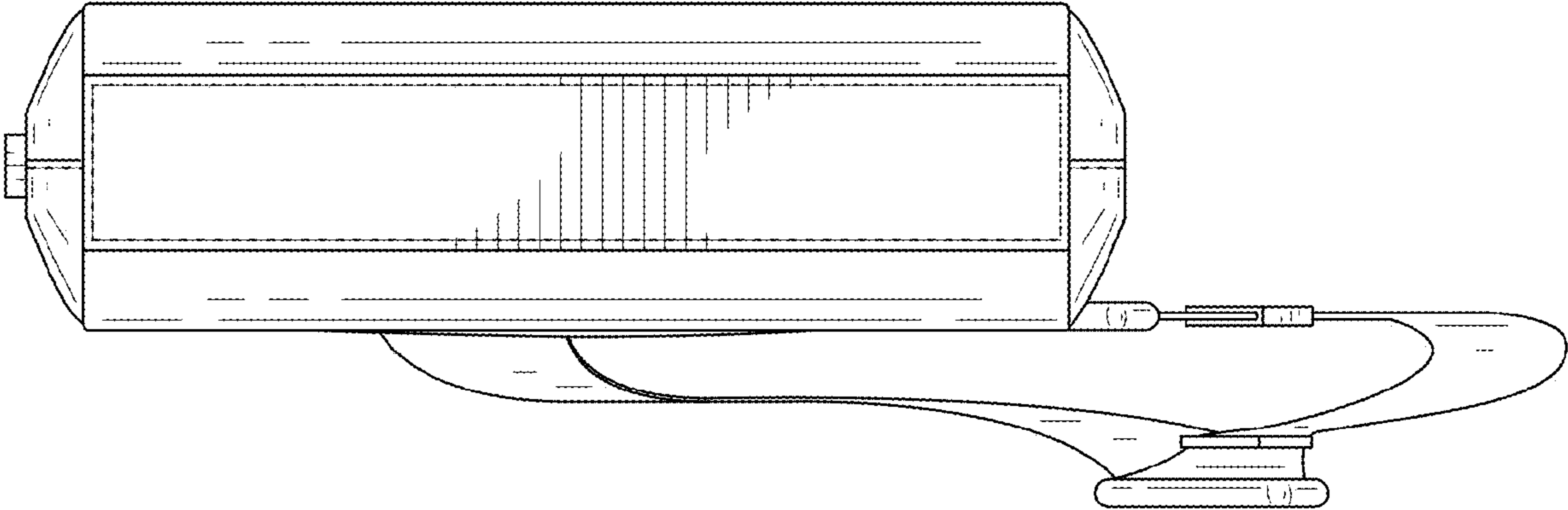

FIG. 7