



US00D986530S

(12) **United States Design Patent** (10) **Patent No.:** **US D986,530 S**
Torano et al. (45) **Date of Patent:** **** May 23, 2023**

(54) **GARMENT**

(71) Applicant: **Spanx, LLC**, Atlanta, GA (US)

(72) Inventors: **Deneb Torano**, Atlanta, GA (US);
Wendy Hanson Allen, Atlanta, GA (US);
Jennifer Roberts Johnson, Atlanta, GA (US)

(73) Assignee: **Spanx, LLC**, Atlanta, GA (US)

(**) Term: **15 Years**

(21) Appl. No.: **29/783,483**

(22) Filed: **May 13, 2021**

(51) **LOC (14) Cl.** **02-01**

(52) **U.S. Cl.**
USPC **D2/701**

(58) **Field of Classification Search**
USPC D2/700, 701, 702, 703, 705, 706, 707,
D2/708, 710, 731, 732
CPC A41C 3/0057; A41C 3/0078; A41C 3/06;
A41C 1/00; A41C 1/06; A41C 1/10;
A41C 3/0007; A41C 3/0014; A41C 1/08;
A41B 9/06; A41B 9/08
See application file for complete search history.

D175,171 S	7/1955	Kaupp	
2,719,973 A	10/1955	Blatt	
D177,067 S	3/1956	Risenfeld	
D177,771 S *	5/1956	Sparadoski	D2/703
2,745,103 A	5/1956	Van Home	
D179,815 S	3/1957	Newman	
D180,834 S *	8/1957	Leventhal	D2/702
3,035,586 A	5/1962	Bell	
3,056,410 A	10/1962	Pierson	
3,137,300 A	6/1964	Gingras	
3,137,301 A	6/1964	Gingras	
3,175,560 A	3/1965	Menzies	
3,194,240 A	7/1965	Mayer	
3,212,504 A	10/1965	Sheldon	
D204,377 S *	4/1966	Glines	D2/702
3,245,409 A	4/1966	Martin	
D205,894 S	10/1966	Lobbenberg	
3,283,759 A	11/1966	Welsch	
3,339,554 A	9/1967	Nobbs	
3,478,748 A	11/1969	Bjorn-Larsen	
3,756,247 A	9/1973	Hand	
D238,623 S	2/1976	Cascio	
D245,292 S	8/1977	Curry	
D252,656 S *	8/1979	Bergh	D2/703
D321,083 S	10/1991	Thygesen	
D338,543 S	8/1993	van Laar	
D348,973 S	7/1994	Stewart	
D370,552 S	6/1996	Erwin	
D376,403 S	12/1996	Kato	
D413,424 S	9/1999	Davies	
D416,124 S	11/1999	Davies	
D491,334 S	6/2004	Parker	
D576,777 S	9/2008	Herbert	
7,631,367 B2	12/2009	Caillibotte	
D607,547 S	1/2010	Maier	
D616,627 S *	6/2010	Schindler	D2/702
D623,377 S *	9/2010	Schindler	D2/700
D632,051 S *	2/2011	Schindler	D2/702
D632,052 S *	2/2011	Schindler	D2/702
D632,053 S *	2/2011	Schindler	D2/702
D641,128 S *	7/2011	Zarabi	D2/703
D641,130 S *	7/2011	Zarabi	D2/703
D665,558 S *	8/2012	Schindler	D2/701
D666,384 S *	9/2012	Schindler	D2/701
D667,607 S *	9/2012	Schindler	D2/702
8,376,808 B2	2/2013	Hopkins	
D697,693 S	1/2014	Choi	
D707,920 S	7/2014	Hays	
D725,347 S	3/2015	Kirkwood	
D758,701 S *	6/2016	Chiang	D2/840
D793,032 S *	8/2017	Carpenter	D2/731
9,750,288 B2	9/2017	Gehlhausen	
D818,597 S	5/2018	Worstman	

(56) **References Cited**
U.S. PATENT DOCUMENTS

D14,535 S	1/1884	Bowers
D15,215 S	8/1884	Ramsey
1,414,205 A	4/1922	Redmond
1,693,799 A	12/1928	Scofield
D87,354 S	7/1932	Pittman
2,021,033 A	11/1935	Thomas
D118,425 S	1/1940	Kops
2,471,348 A	5/1949	Redmond
D161,608 S	1/1951	Arseneault
D162,661 S	3/1951	Imershein
D166,363 S	4/1952	Terry
D167,631 S	9/1952	Imershein
2,641,762 A	6/1953	Greco
D170,694 S	10/1953	Kahn
2,707,280 A	5/1955	Mayer

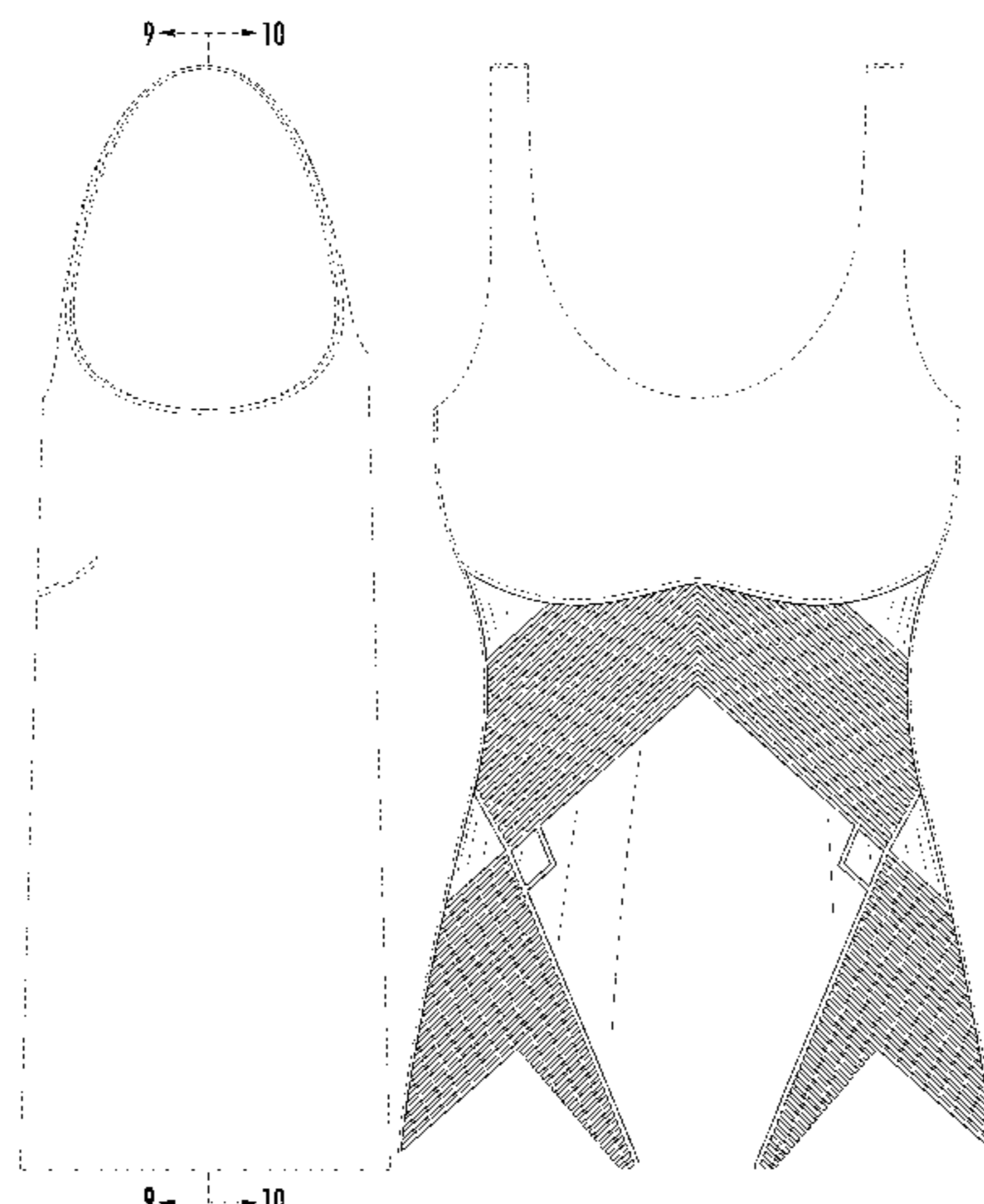

D822,946	S	*	7/2018	Stewart	D2/708
D906,631	S	*	1/2021	Lin	D2/701
D909,009	S		2/2021	Huang		
D915,735	S	*	4/2021	Fischer	D2/701
D922,731	S		6/2021	Touidjine-Williams		
D923,916	S		7/2021	Warren, Jr.		
2015/0038052	A1		2/2015	Hays		
2016/0073704	A1		3/2016	Basta		
2019/0045855	A1		2/2019	Musciacchio		
2019/0116898	A1*		4/2019	Ulrich	A41C 3/08

FOREIGN PATENT DOCUMENTS

CN	306145531	11/2020
CN	306275470	1/2021
EM	18361-0001	9/2003
JP	D1295165	2/2007
JP	D1375277	12/2009
JP	D1416124	6/2011
JP	D1468790	5/2013

OTHER PUBLICATIONS

Contour Lift and Shape Camisole, posting date not available [online], [retrieved Dec. 12, 2022]. Retrieved from internet, <https://atom.fit/products/lift-shape-camisole> (Year: 2022).*

Sportsupport Postpartum Crossback Tank, posting date not available [online], [retrieved Dec. 12, 2022]. Retrieved from internet, <https://www.blanqi.com/products/sportsupport-postpartum-crossback-tank> (Year: 2022).*

Honeylove Liftwear Tank, posting date not available [online], [retrieved Dec. 12, 2022]. Retrieved from internet, <https://www.barenecessities.com/product.aspx> (Year: 2022).*

Contour Tank, posting date not available [online], [retrieved Dec. 12, 2022]. Retrieved from internet, <https://www.jalaclothing.com/products/contour-tank-bone> (Year: 2022).*

Back Support Control Tank, posting date not available [online], [retrieved Dec. 12, 2022]. Retrieved from internet, <https://www.macys.com/shop/product/back-support-control-tank> (Year: 2022).*

Spanx Thinstincts Collection—Lightweight Tummy Shapewear, available at spanx.com, retrieved from https://spanx.com/collections/thinstincts-collection?gclid=EAialQobChMI04ni3uCa9AIVYQaICR3KbwzXE.AAYASABEgJ04vD_BwE&gclid=aw.ds, 2021, 2 pages.

Spanx Thinstincts 2.0 Mid-Thigh High Waist Shorts, available at [dillards.com](https://www.dillards.com/p/spanx-thinstincts-2.0-mid-thigh-high-waist-shorts/512511302), earliest customer review date Apr. 2021, retrieved from <https://www.dillards.com/p/spanx-thinstincts-2.0-mid-thigh-high-waist-shorts/512511302>, 2021, 3 pages.

Spanx Thinstincts 2.0 High-Waisted Mid Thigh Shorts, available at [dillards.com](https://www.dillards.com/p/spanx-thinstincts-2.0-high-waisted-mid-thigh-shorts/512511252), earliest customer review date Mar. 2021, retrieved from <https://www.dillards.com/p/spanx-thinstincts-2.0-high-waisted-mid-thigh-shorts/512511252>, 2021, 3 pages.

Spanx Thinstincts 2.0 High Waisted Mid Thigh Short, retrieved from <https://www.qvc.com/Spanx-Trust-Your-Thinstincts-20-High-Waisted-Mid-Thigh-Short.product.A399799.html??TZ=EST>, 2021, 5 pages.

Spanx Thinstincts 2.0 Open-Bust Mid-Thigh Bodysuit, available at [dillards.com](https://www.dillards.com/p/spanx-thinstincts-2.0-open-bust-rnid-thigh-bodysuit/512511305), earliest customer review date Apr. 2021 retrieved from <https://www.dillards.com/p/spanx-thinstincts-2.0-open-bust-rnid-thigh-bodysuit/512511305>, 2021, 3 pages.

Spanx Thinstincts 2.0 Flat Neck Tummy Shaping Tank, available at [dillards.com](https://www.dillards.com/p/spanx-thinstincts-2.0-lightweight-flat-neck-tummy-shaping-tank/513360775), earliest customer review date Aug. 2021, retrieved from <https://www.dillards.com/p/spanx-thinstincts-2.0-lightweight-flat-neck-tummy-shaping-tank/513360775>, 2021, 3 pages.

Spanx Trust Your Thinstincts 2.0 Brief Panty, earliest customer review date Aug. 18, 2018, retrieved from <https://www.qvc.com/Spanx-Trust-Your-Thinstincts-20-Brief-Panty.product.A399796.html>, 2018, 5 pages.

Spanx Thinstincts 2.0 Mid-Thigh Short Black, retrieved from <https://www.kastner-oehler.de/spanx-thinstincts-20-mid-thigh-short-soft-nude-beige-7402910.html>, 2021, 2 pages.

* cited by examiner

Primary Examiner — Jonathan J Han
Assistant Examiner — Caitlin Mackenzie Williams
 (74) *Attorney, Agent, or Firm* — Meunier Carlin & Curfman LLC

(57) CLAIM

The ornamental design for a garment, as shown and described.

DESCRIPTION

FIG. 1 is a front perspective view of a garment showing our new design according to a first embodiment.

FIG. 2 is a front view of our new design shown in FIG. 1.

FIG. 3 is a rear view of our new design shown in FIG. 1.

FIG. 4 is a right-side view of our new design shown in FIG. 1.

FIG. 5 is a left-side view of our new design shown in FIG. 1.

FIG. 6 is a top view of our new design shown in FIG. 1.

FIG. 7 is a bottom view of our new design shown in FIG. 1.

FIG. 8 is a front perspective view of our new design shown in FIG. 1 when in use.

FIG. 9 is a cross-sectional view taken along line 9-9 of FIG. 4.

FIG. 10 is a cross-sectional view taken along line 10-10 of FIG. 4.

FIG. 11 is a cross-sectional view taken along line 11-11 of FIG. 2.

FIG. 12 is a front perspective view of a garment showing our new design according to a second embodiment.

FIG. 13 is a front view of our new design shown in FIG. 12.

FIG. 14 is a rear view of our new design shown in FIG. 12.

FIG. 15 is a right-side view of our new design shown in FIG. 12.

FIG. 16 is a left-side view of our new design shown in FIG. 12.

FIG. 17 is a top view of our new design shown in FIG. 12.

FIG. 18 is a bottom view of our new design shown in FIG. 12.

FIG. 19 is a front perspective view of our new design shown in FIG. 12 when in use.

FIG. 20 is a cross-sectional view taken along line 20-20 of FIG. 15.

FIG. 21 is a cross-sectional view taken along line 21-21 of FIG. 15; and,

FIG. 22 is a cross-sectional view taken along line 22-22 of FIG. 13.

The short broken lines showing elements of the garment in the drawings illustrate features of the article of manufacture that form no part of the claimed design. The human figure rendered in short broken lines in FIGS. 8 and 19 illustrates environmental subject matter intended to assist in showing how the design appears when in use and forms no part of the claim.

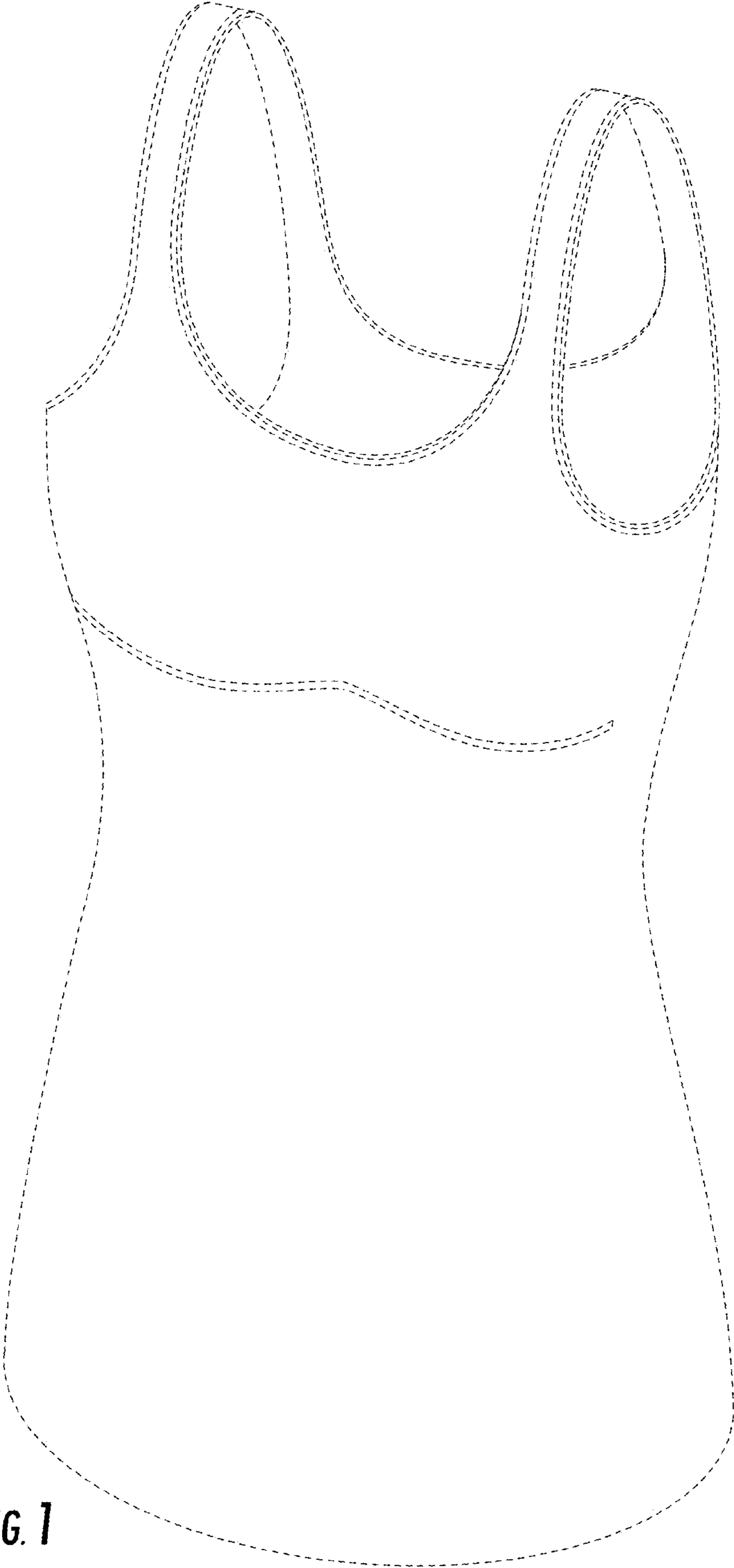

FIG. 1

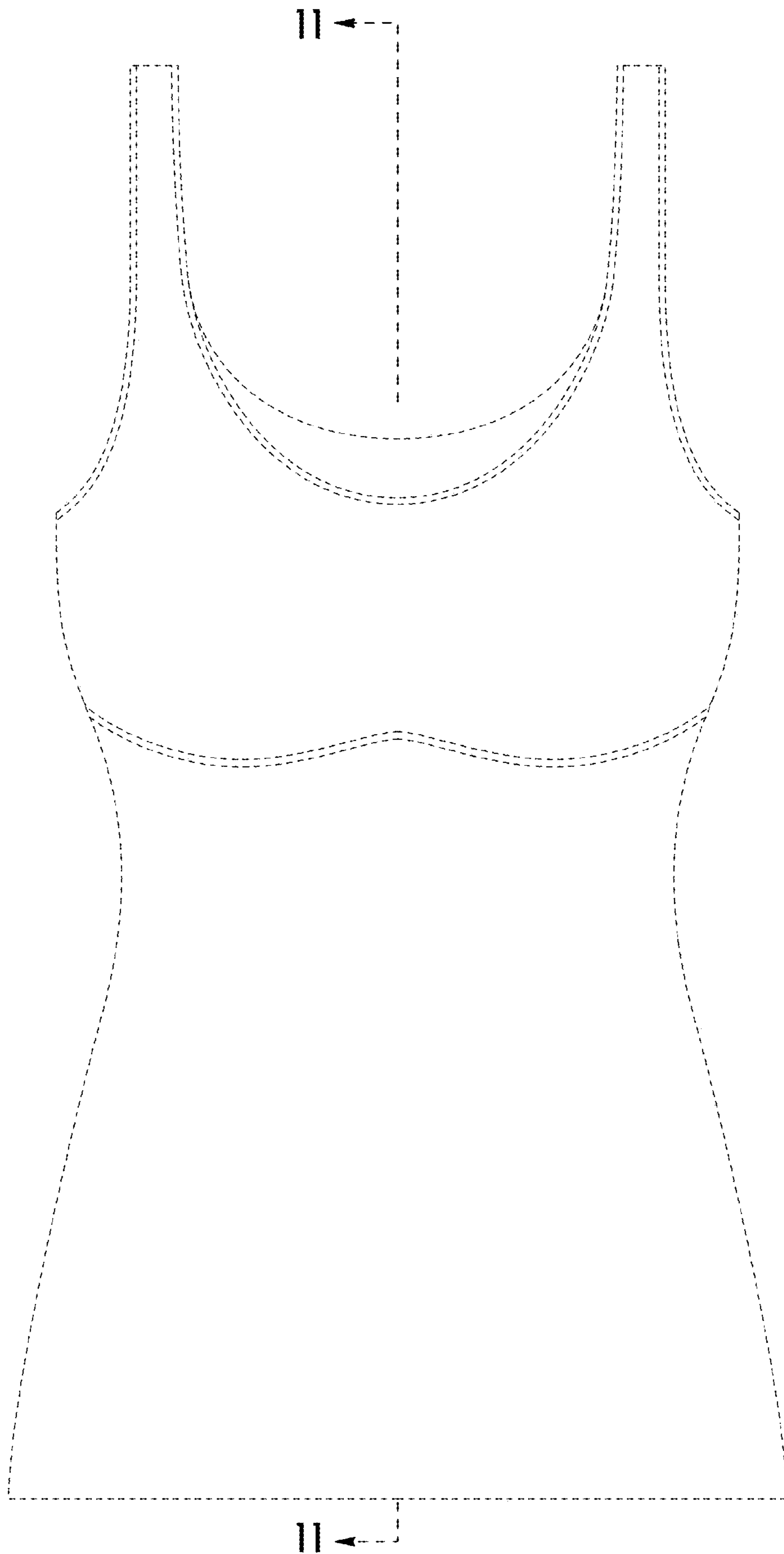

FIG. 2

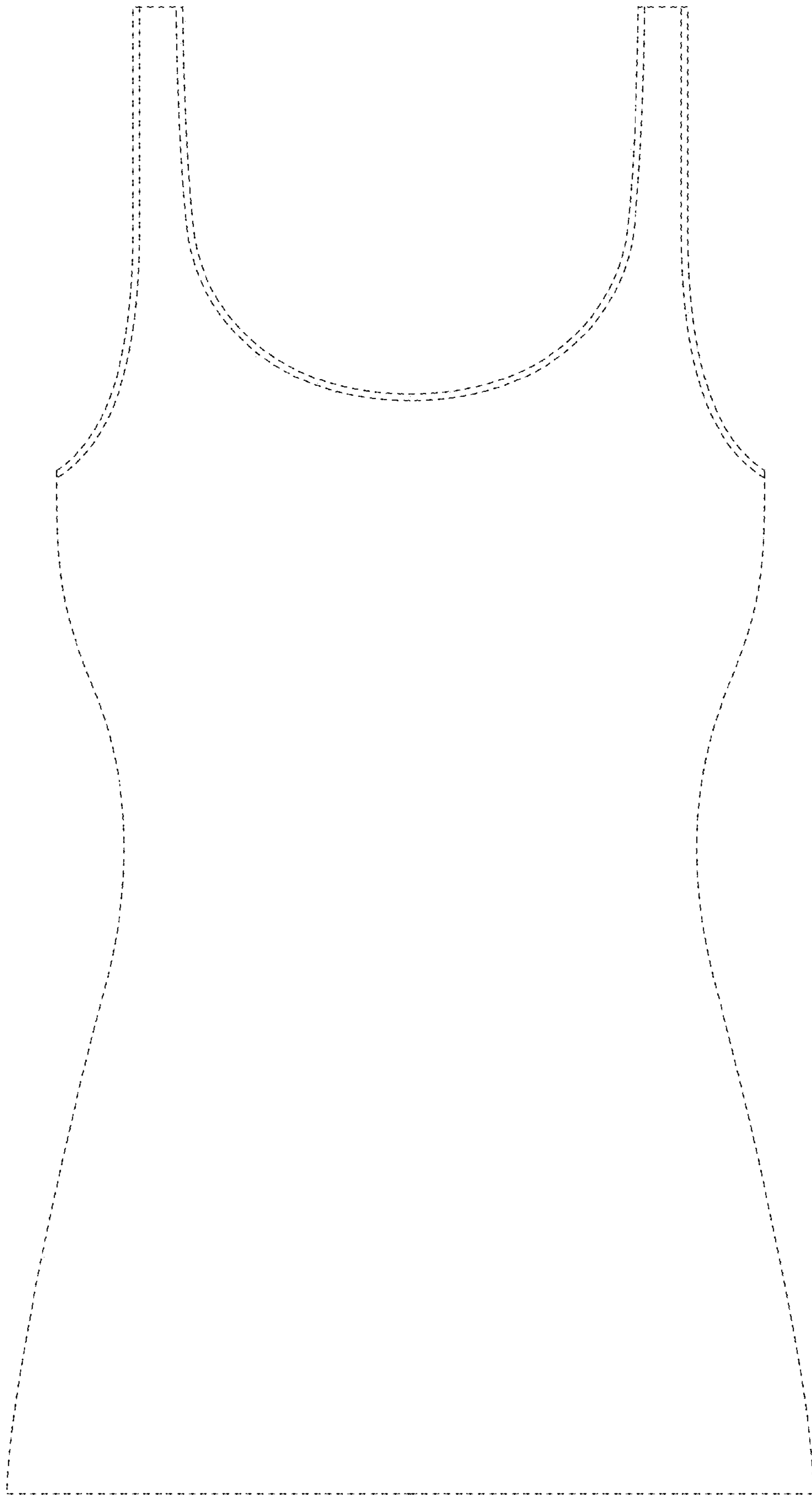

FIG. 3

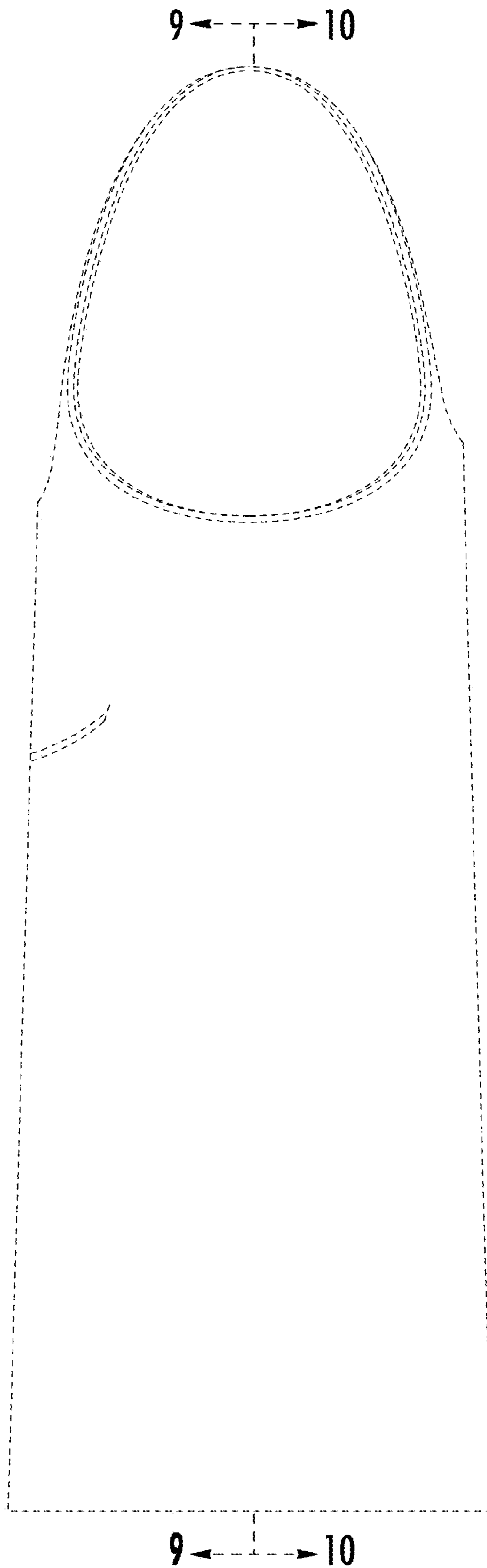

FIG. 4

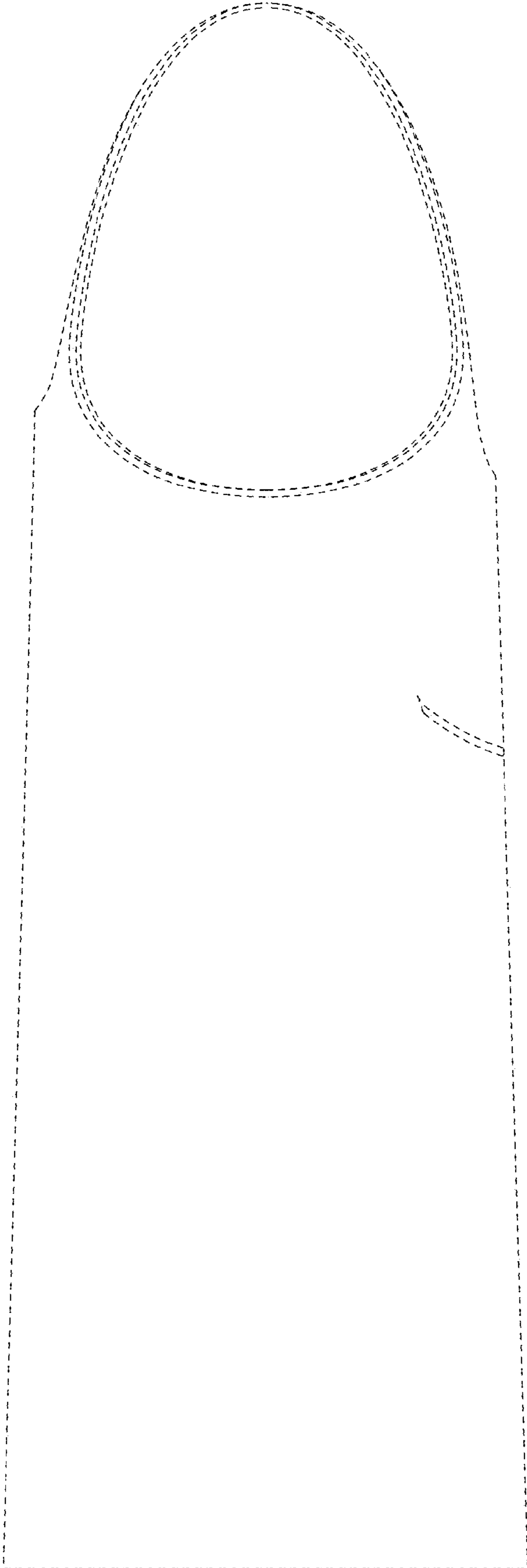

FIG. 5

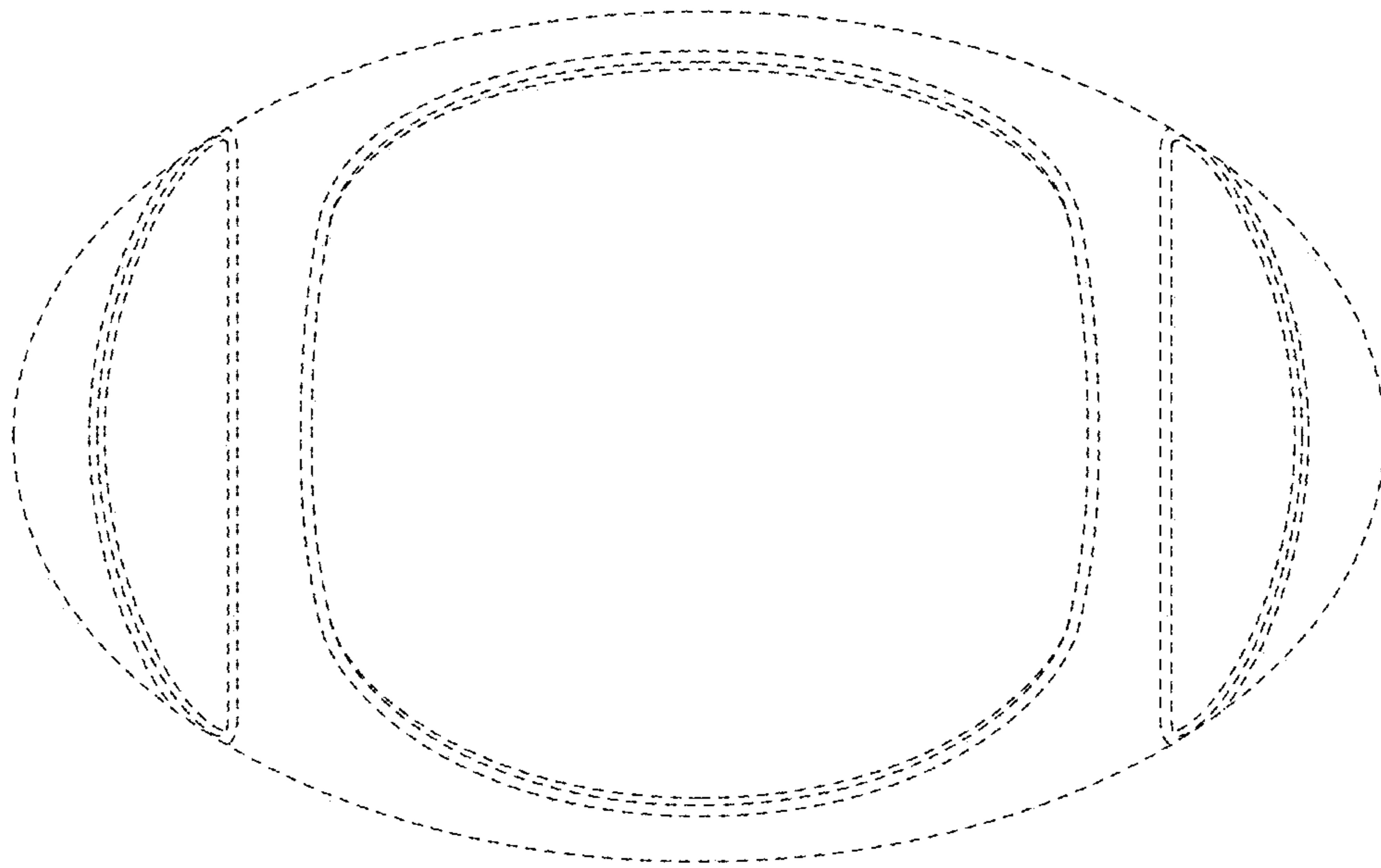

FIG. 6

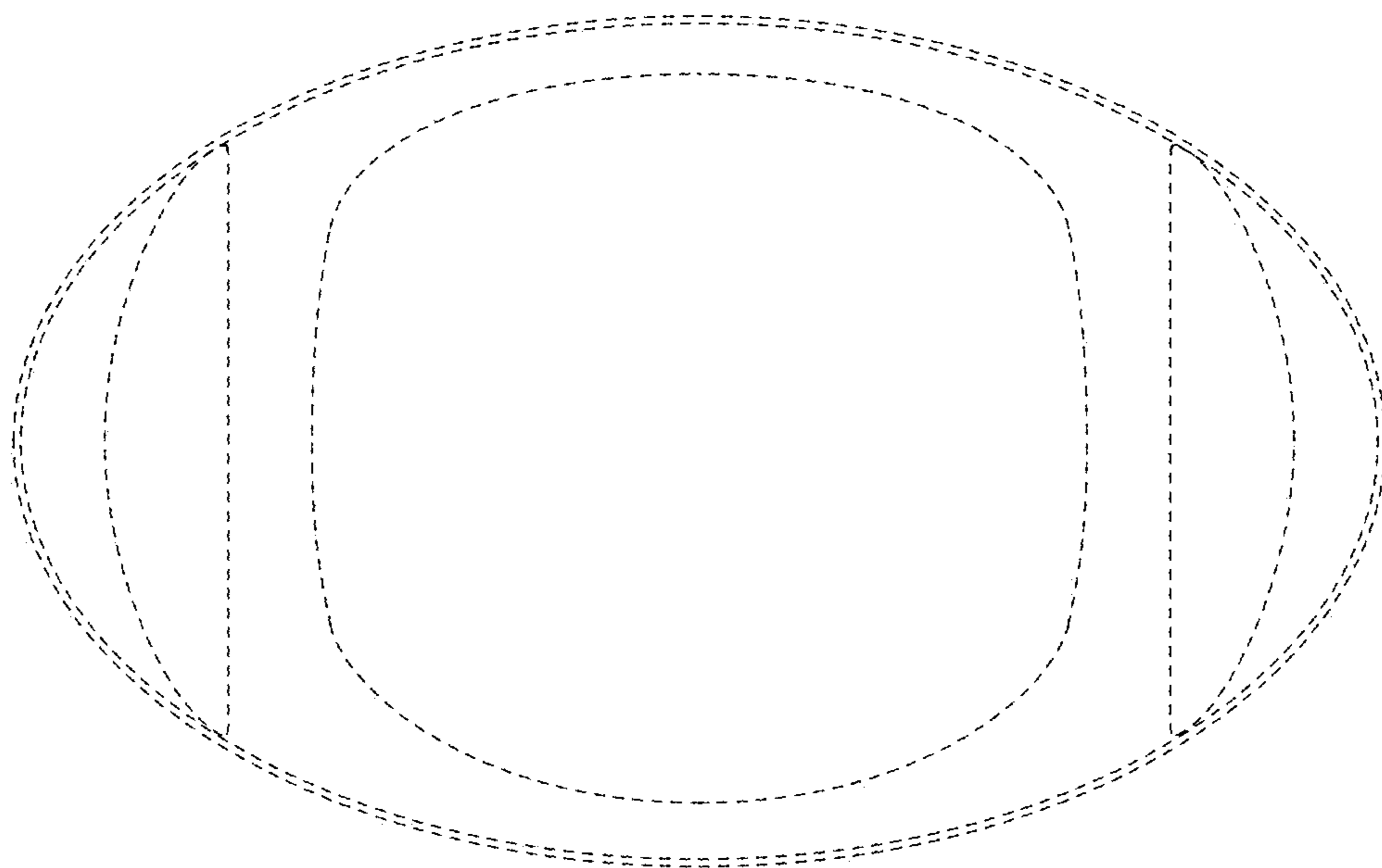

FIG. 7

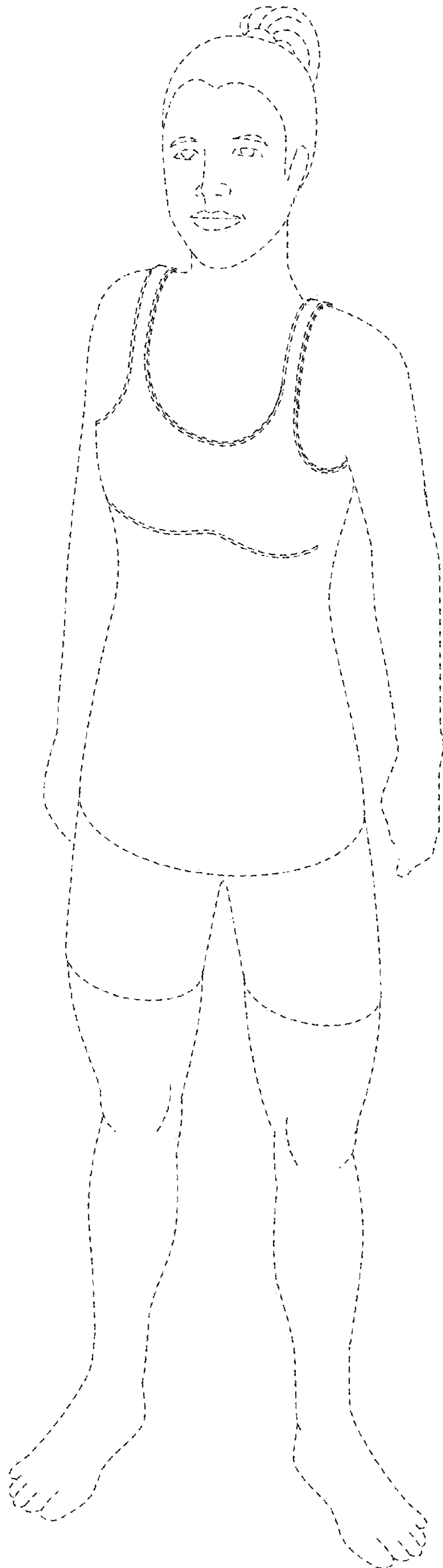

FIG. 8

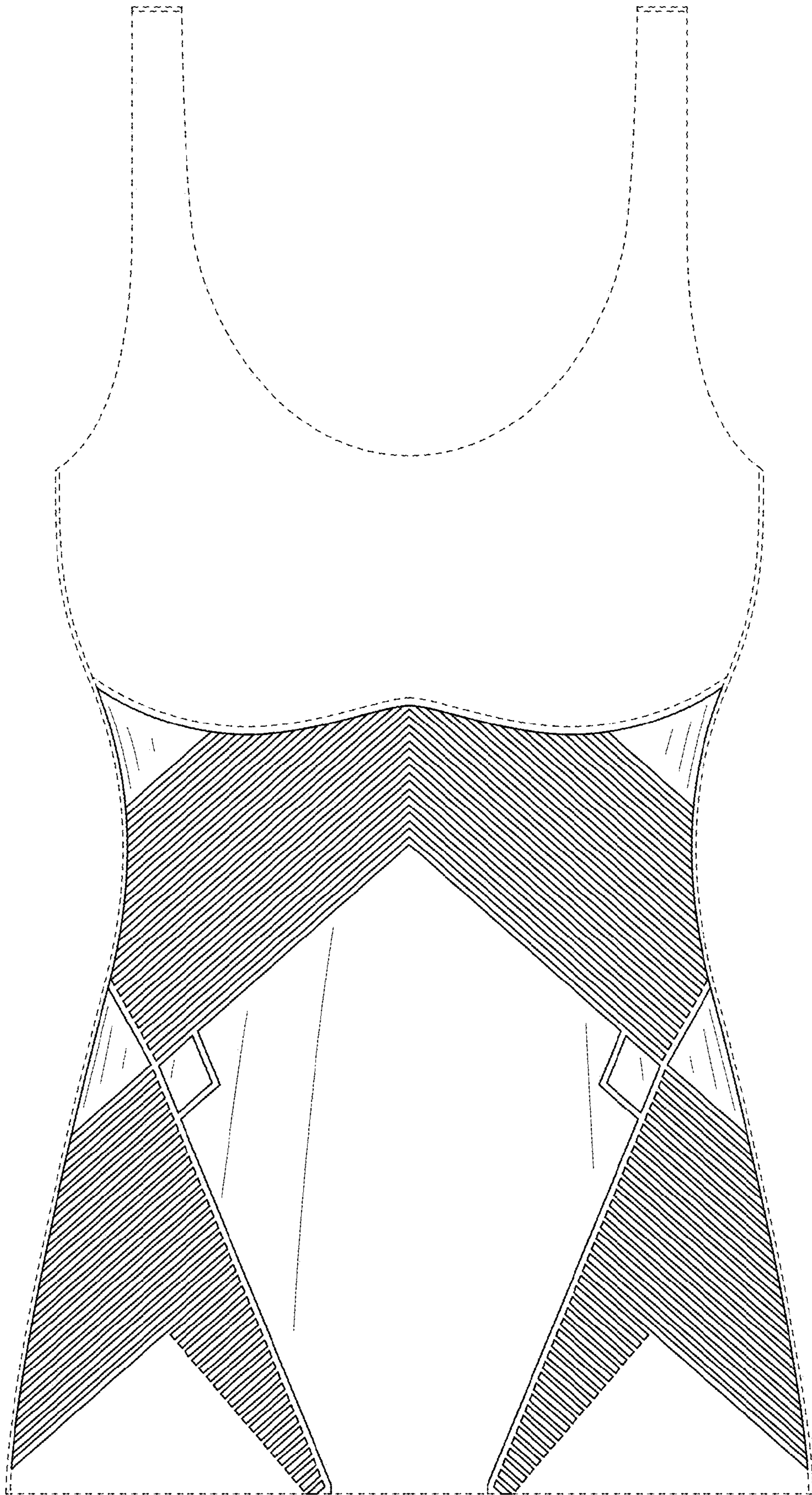

FIG. 9

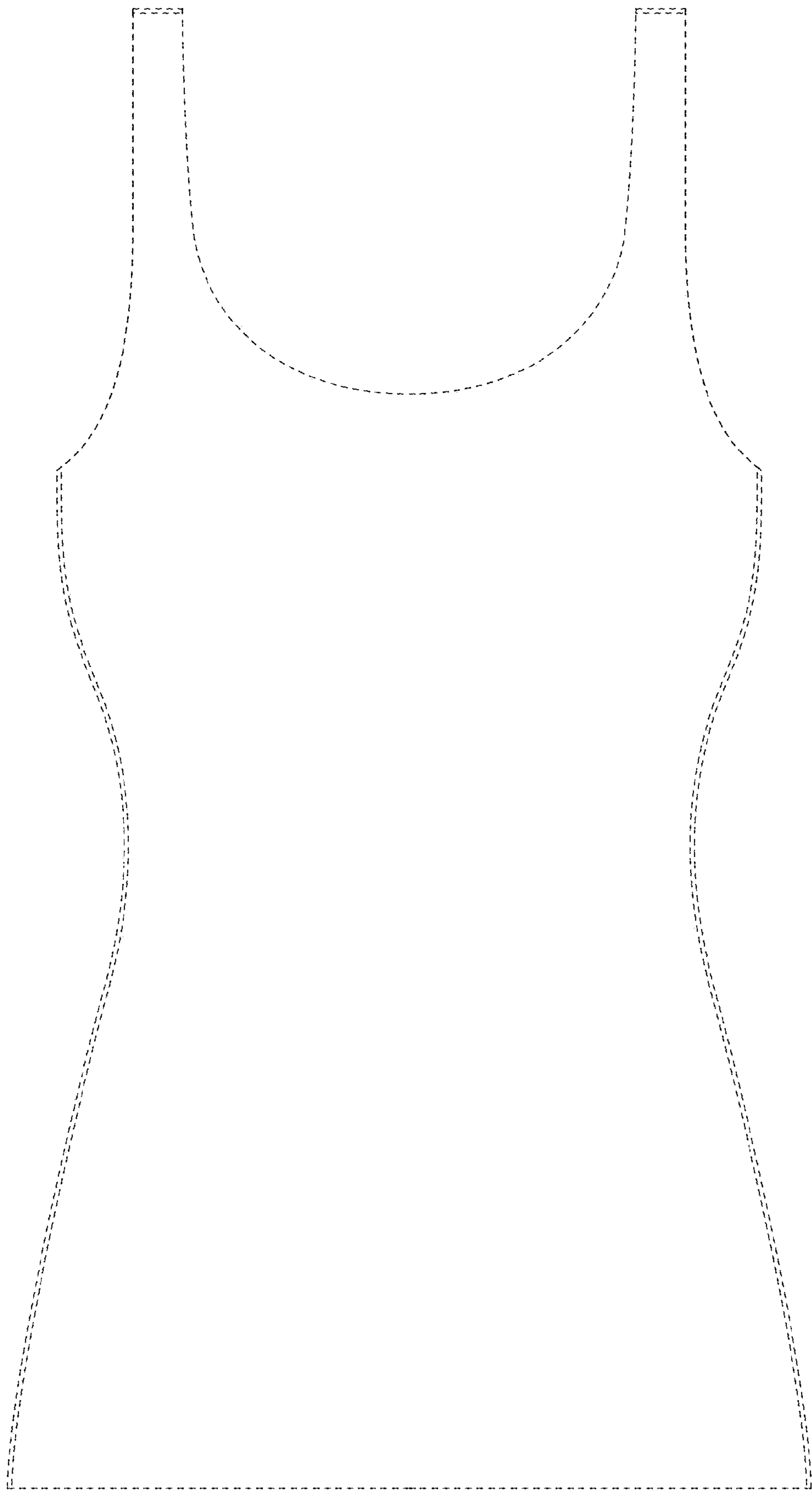

FIG. 10

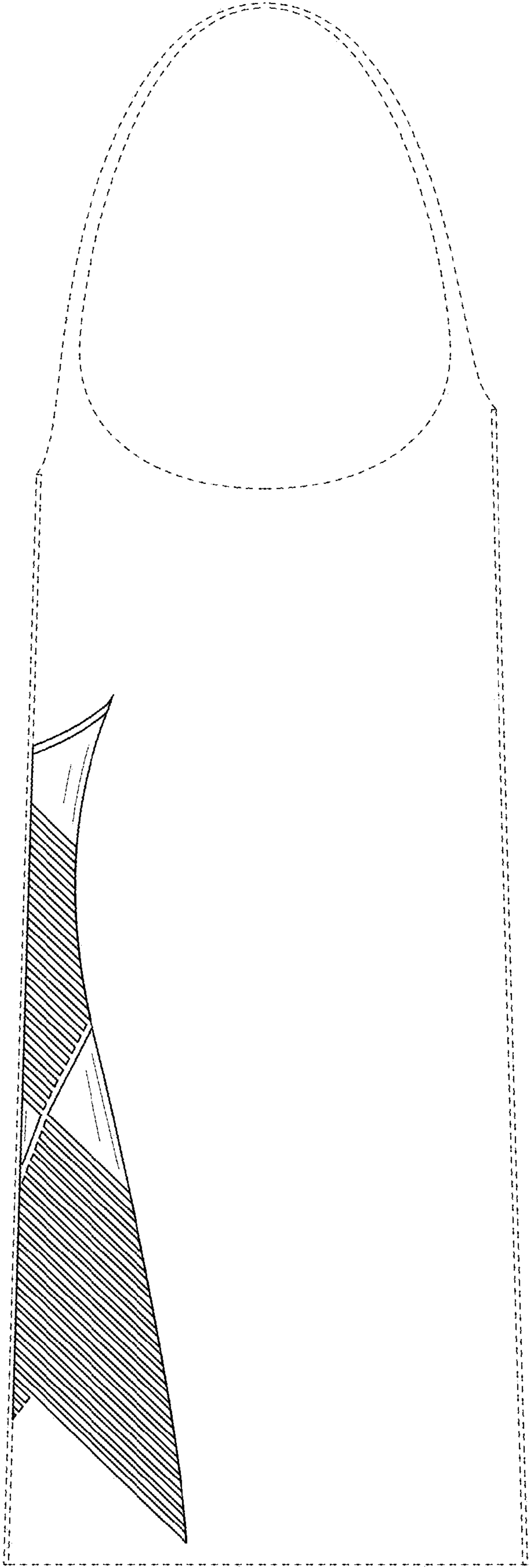

FIG. 11

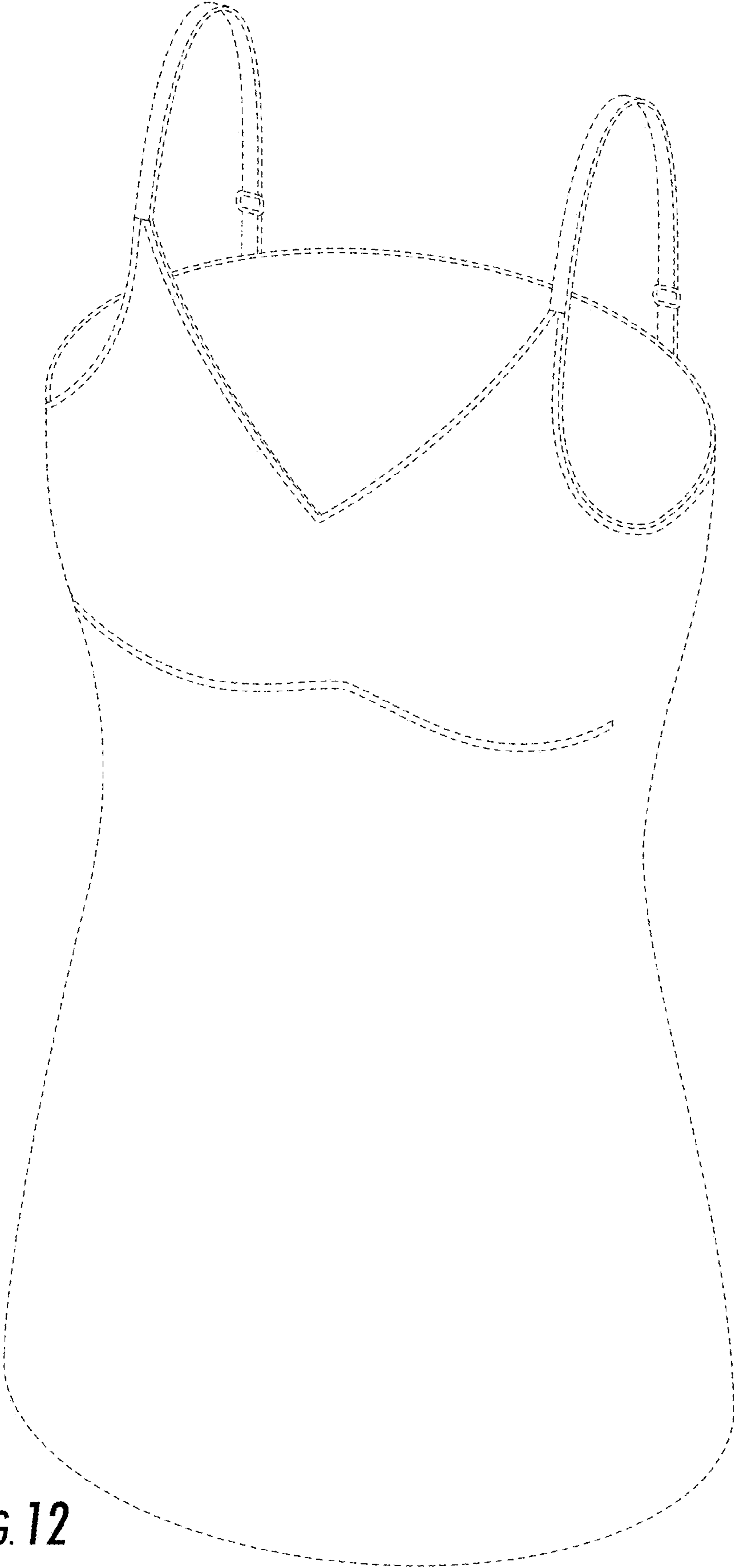

FIG. 12

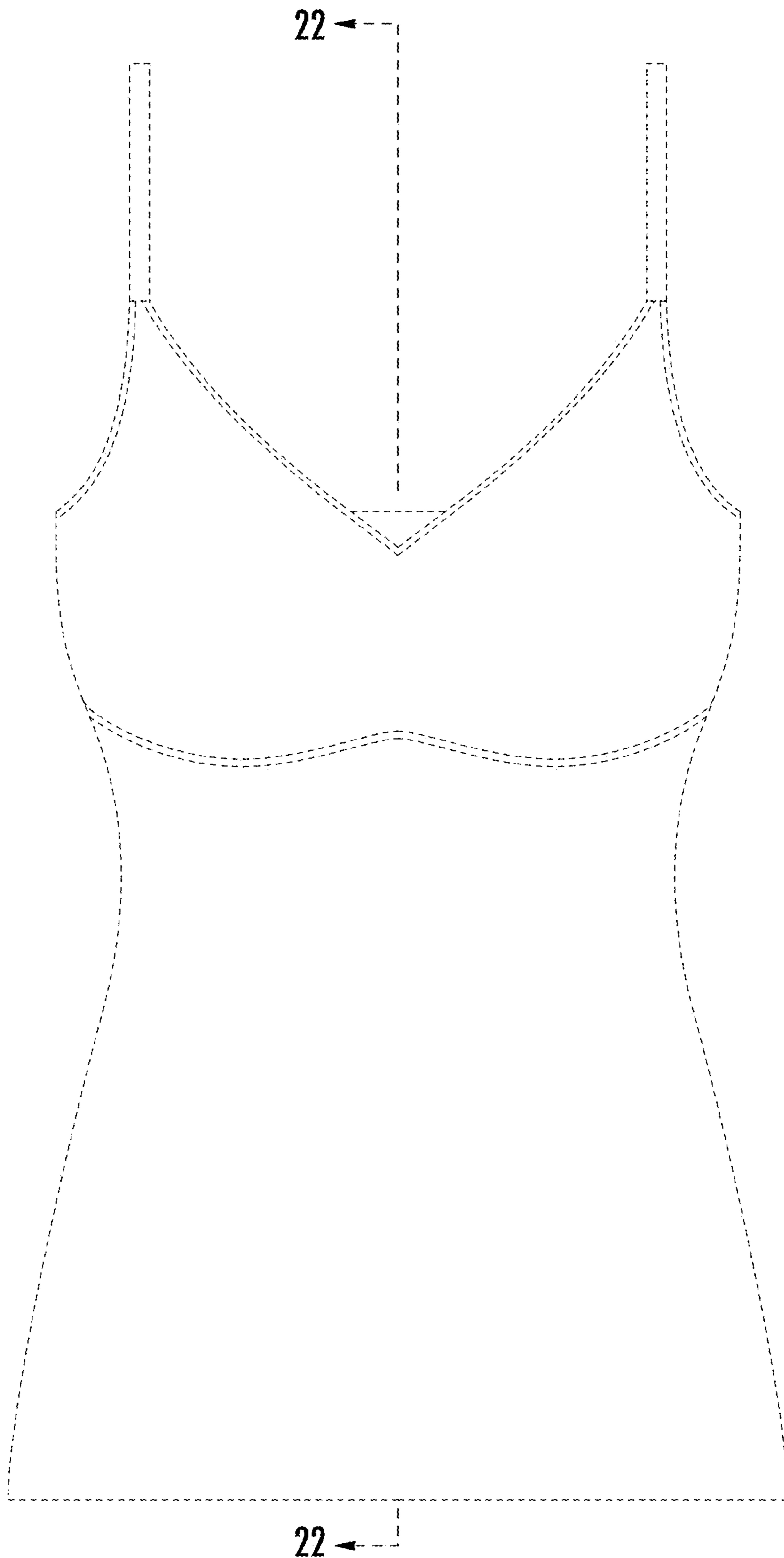

FIG. 13

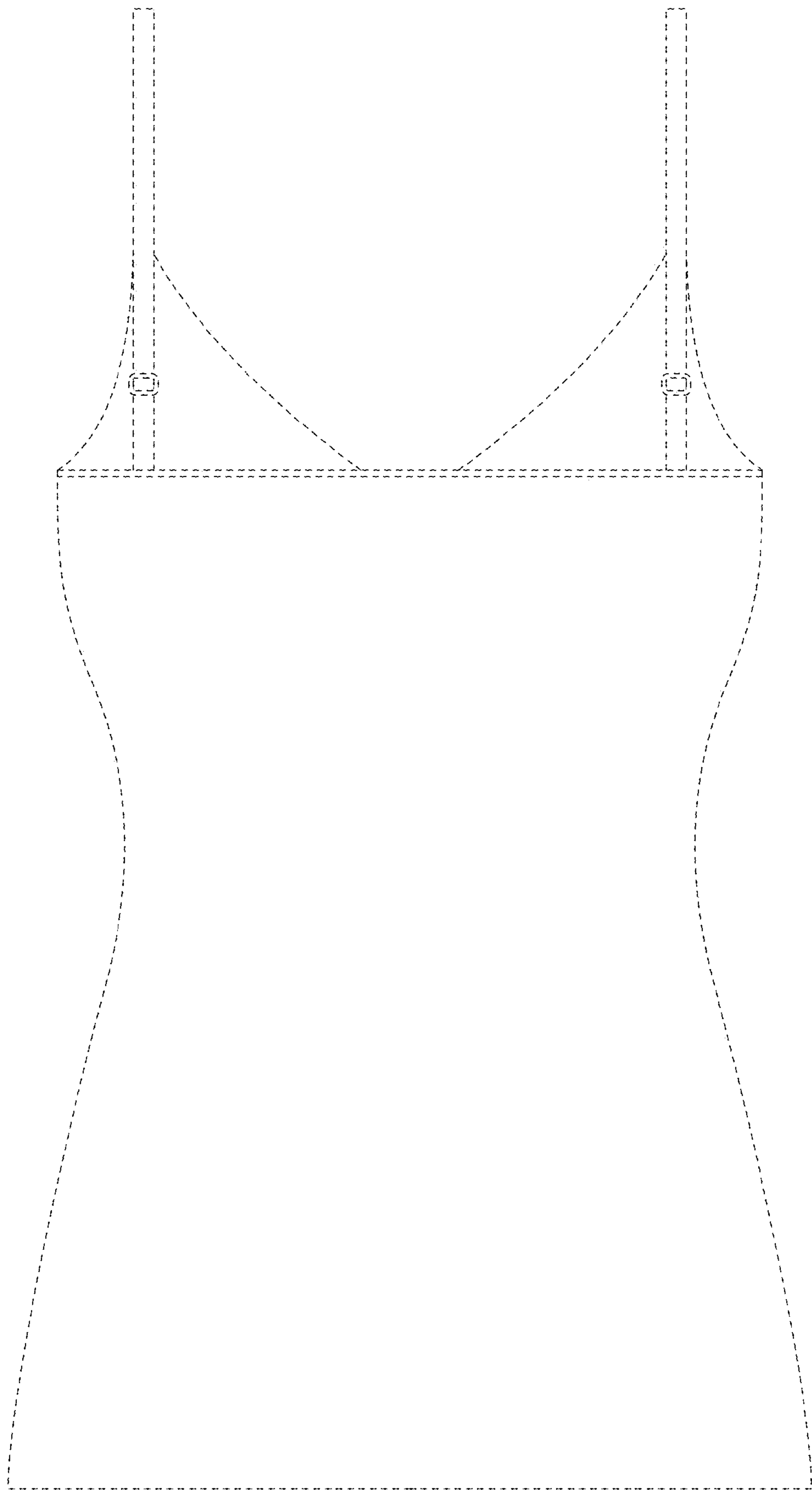
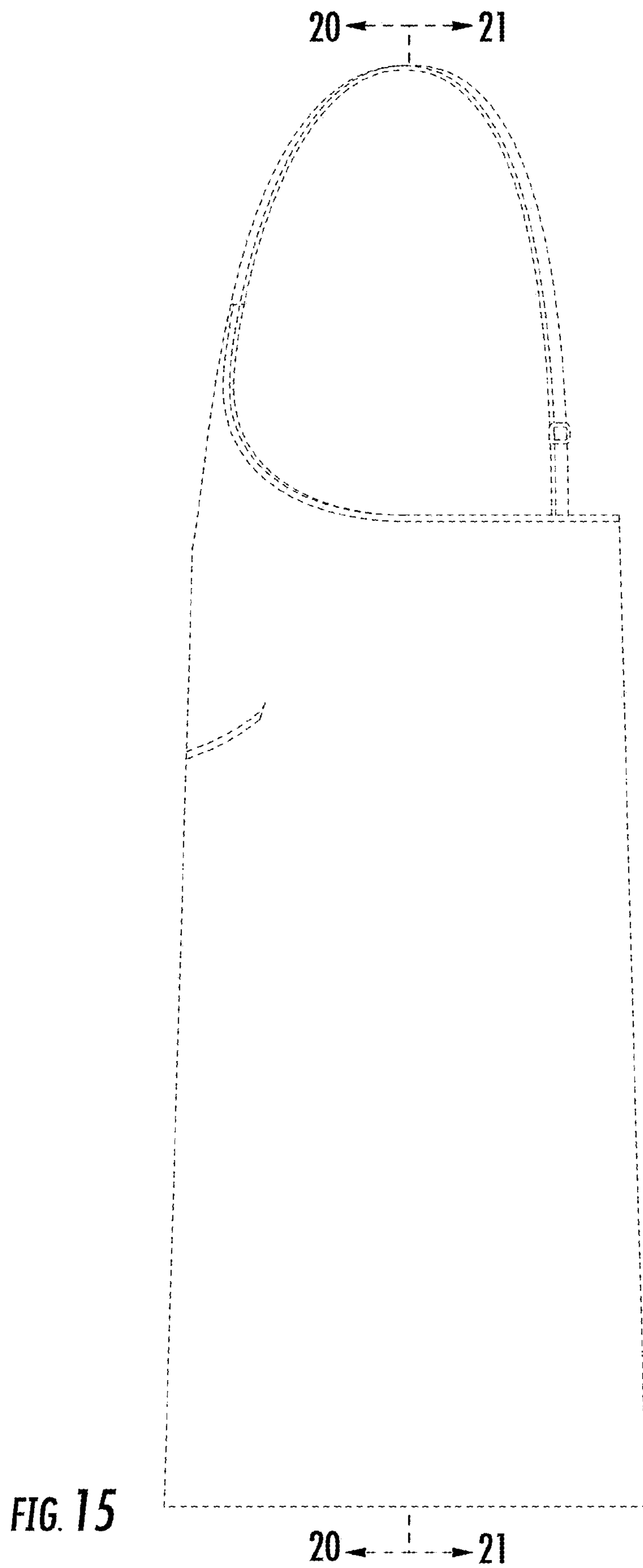

FIG. 14



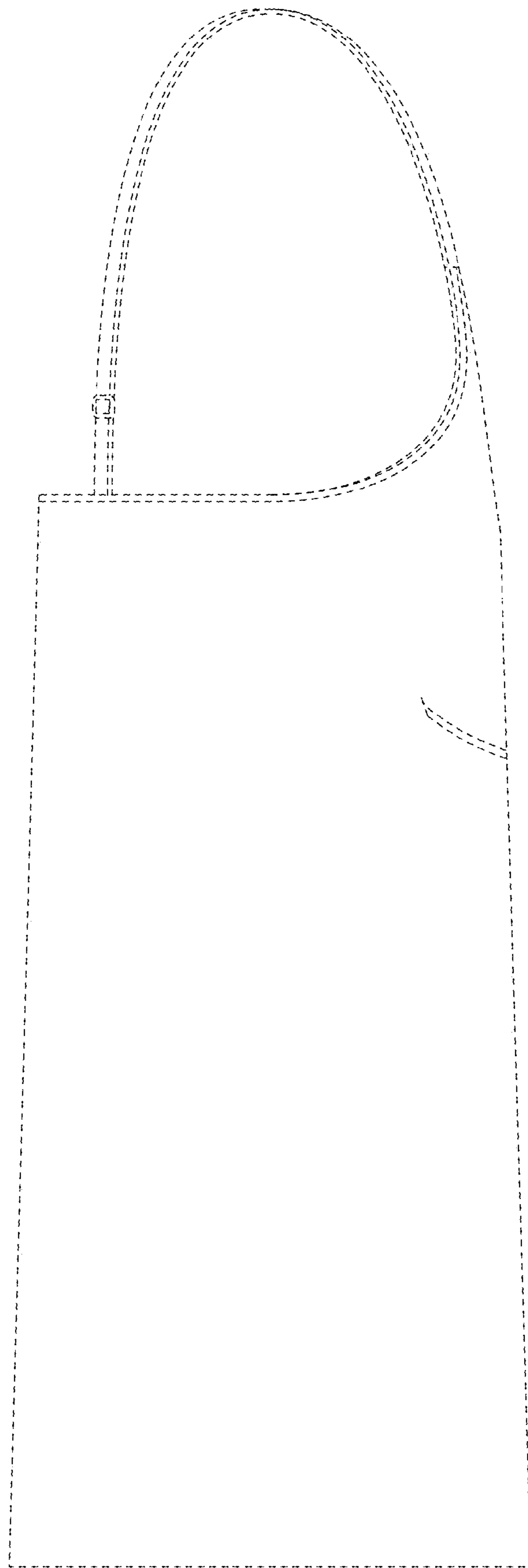

FIG. 16

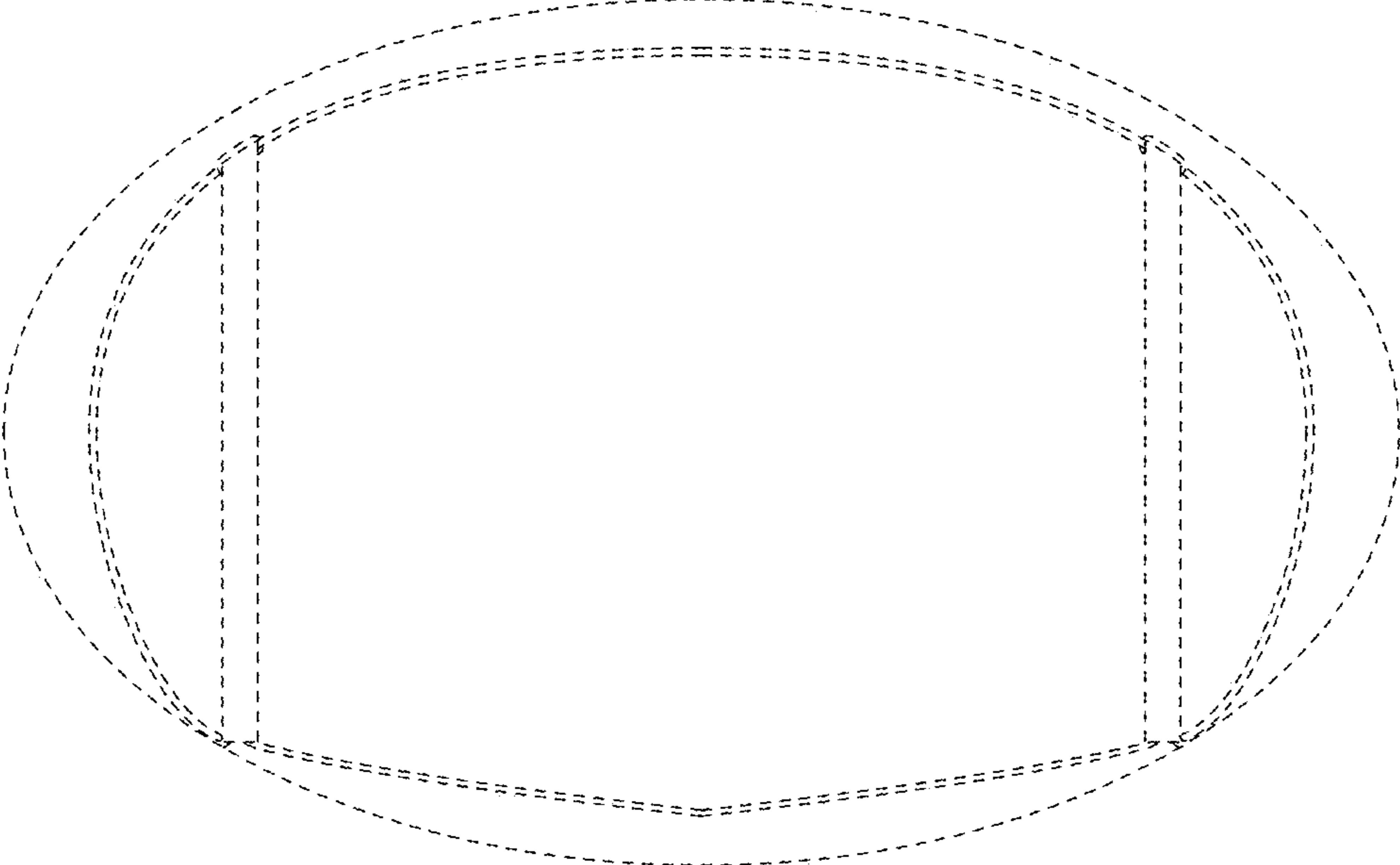

FIG. 17

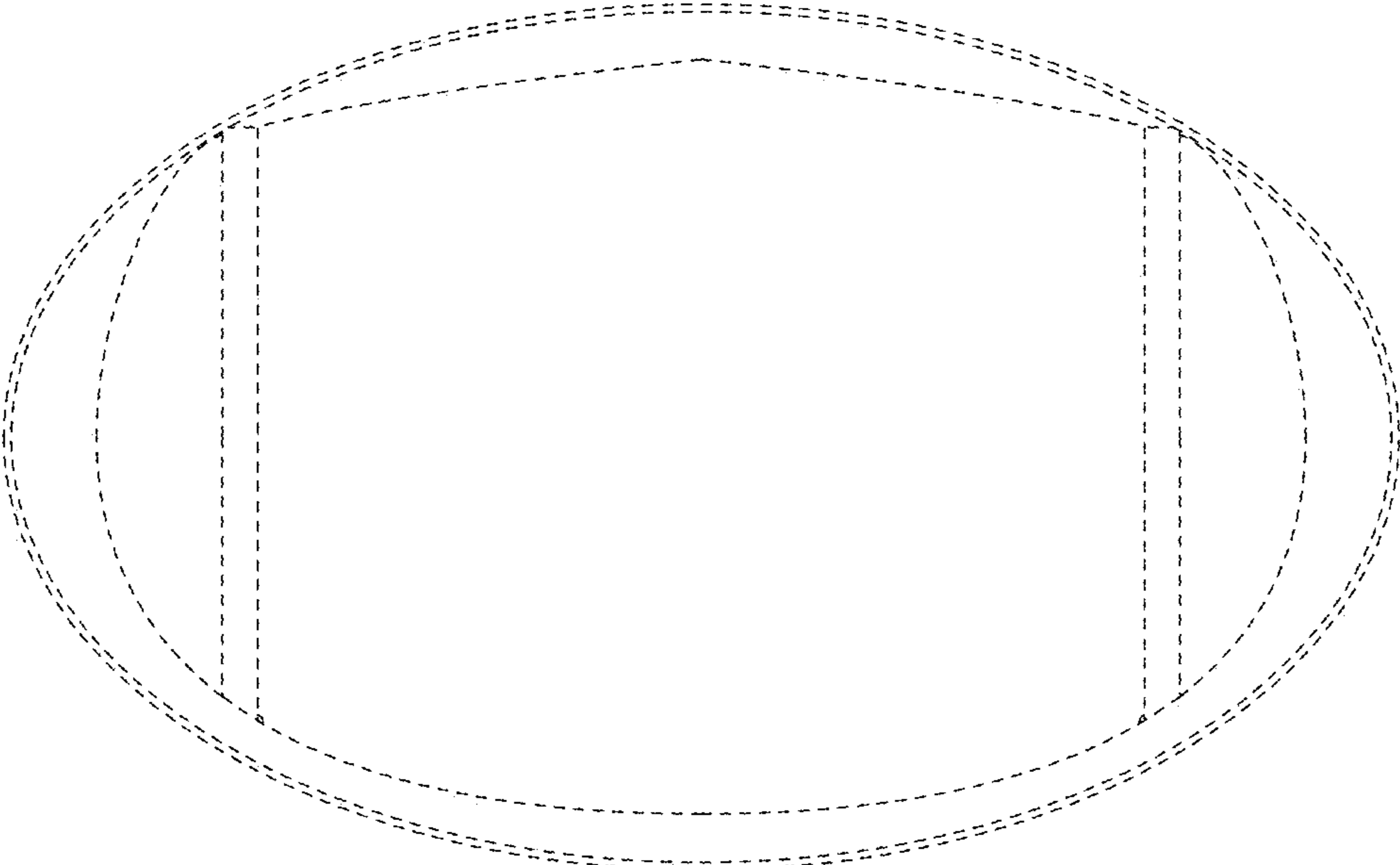

FIG. 18

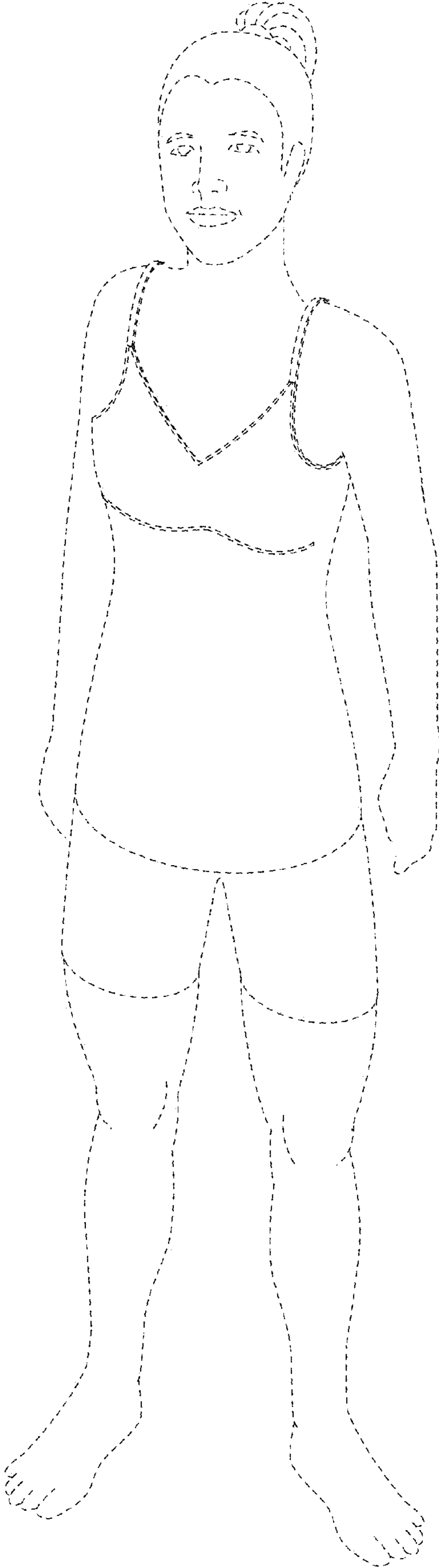

FIG. 19

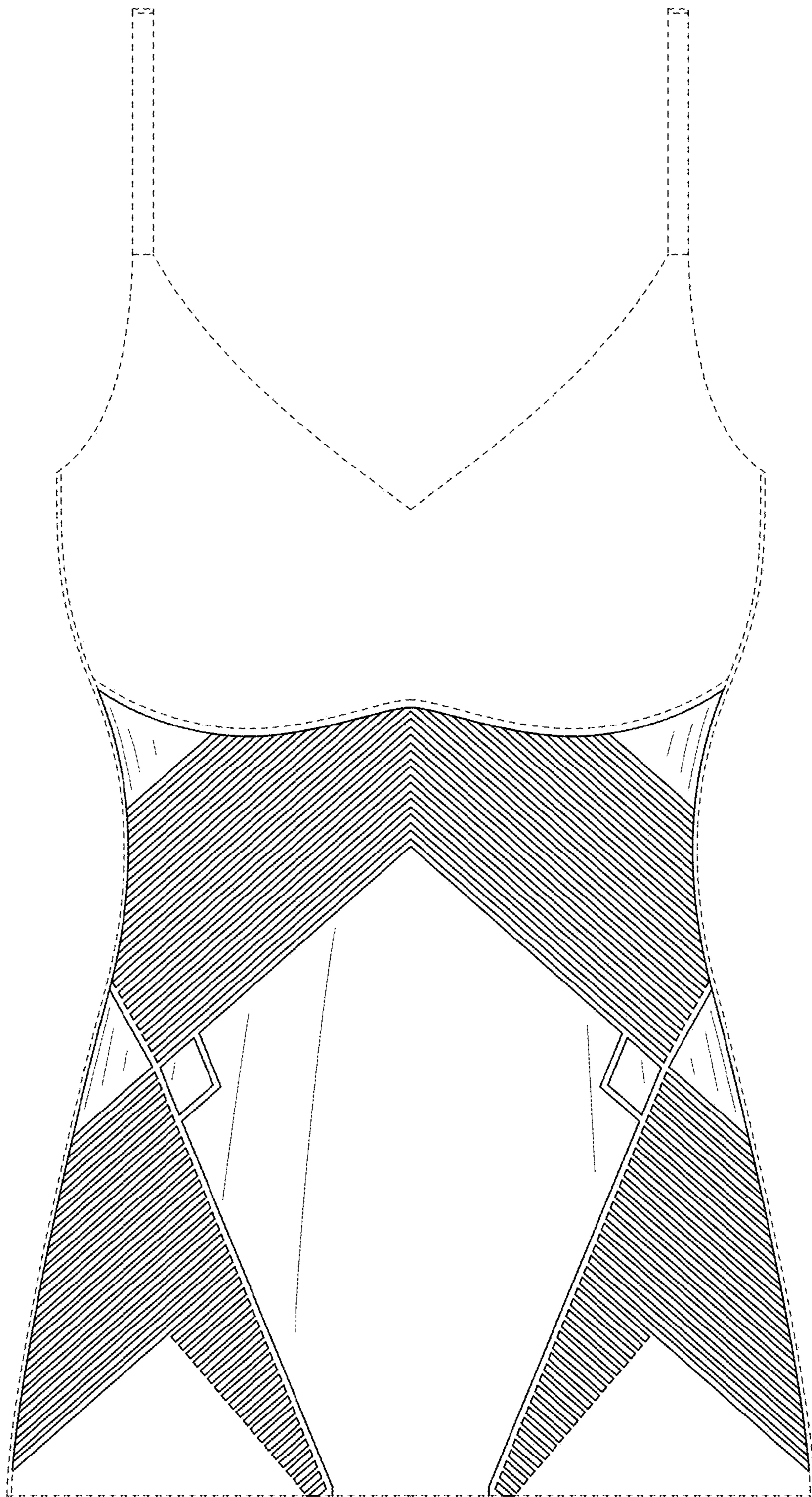

FIG. 20

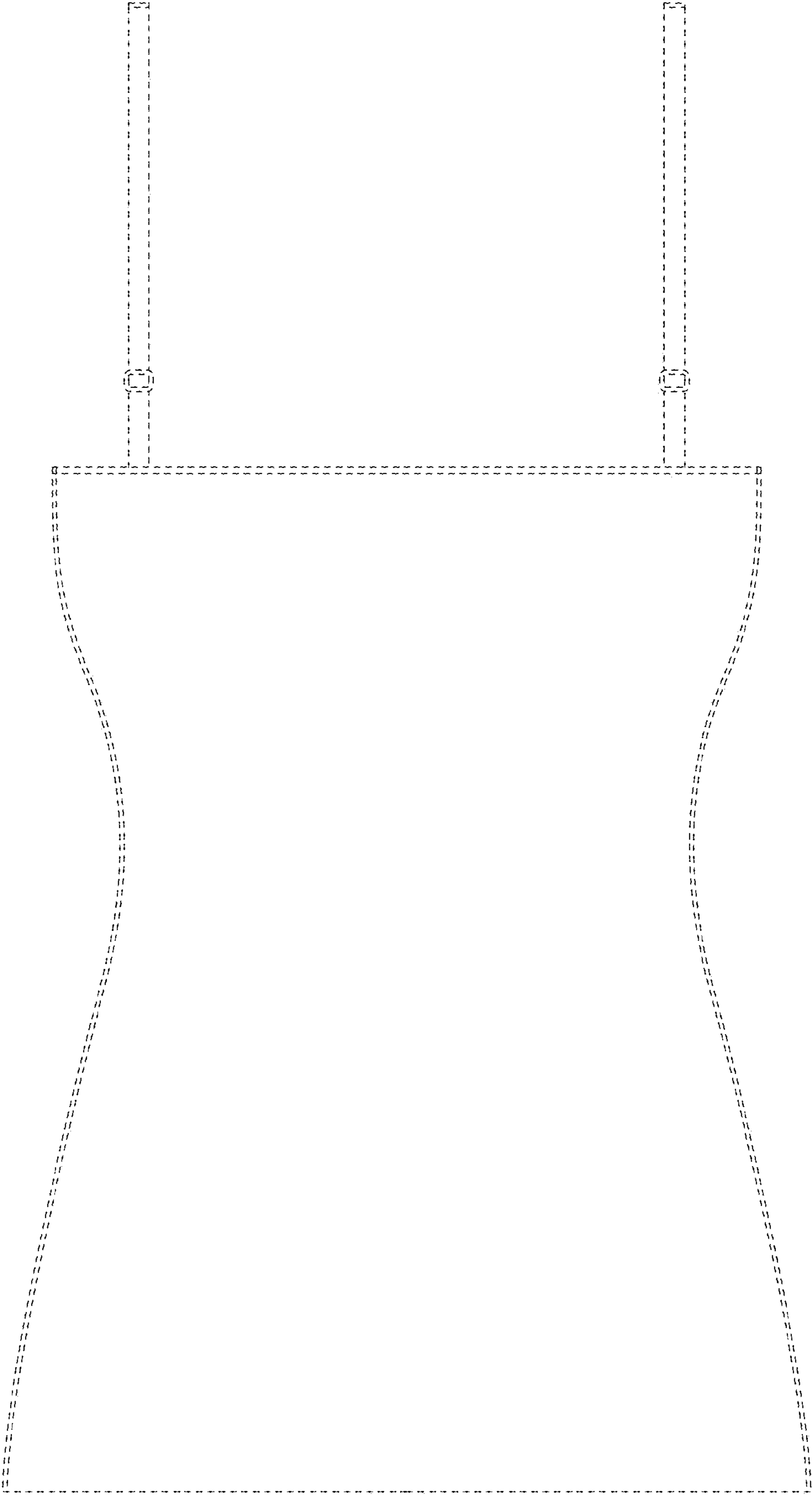

FIG. 21

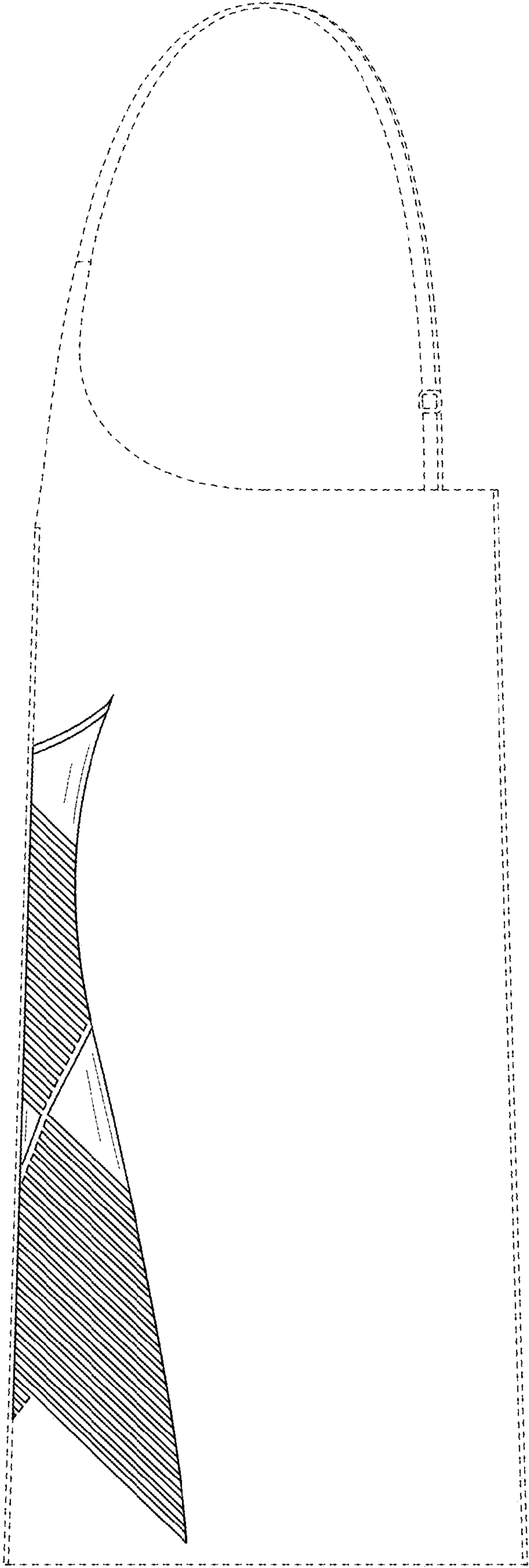

FIG. 22