



US00D986424S

(12) **United States Design Patent**  
**Ben Noon**

(10) **Patent No.:** **US D986,424 S**  
(45) **Date of Patent:** **\*\* May 16, 2023**

(54) **COMPRESSION BOOT**

(71) Applicant: **Mego Afek AC Ltd.**, Doar Afek (IL)

(72) Inventor: **Asher Ben Noon**, Karmiel (IL)

(73) Assignee: **MEGO AFEK AC LTD.**, Doar Afek (IL)

(\*\*) Term: **15 Years**

(21) Appl. No.: **29/765,879**

(22) Filed: **Jan. 12, 2021**

(51) **LOC (14) Cl.** ..... **24-04**

(52) **U.S. Cl.**  
USPC ..... **D24/192**

(58) **Field of Classification Search**  
USPC ..... D24/188, 190–192, 200, 206, 214, 215,  
D24/171, 199, 212, 213; D2/970, 980,  
D2/984–986, 989; D29/120.1, 121.2,  
D29/121.1, 122, 100, 113, 114  
CPC .... A61F 5/0111; A61F 5/0113; A61F 5/0127;  
A61F 5/0585; A61F 5/0195; A61H  
9/0078; A61H 9/0092; A41H 1/008

See application file for complete search history.

(56) **References Cited**

**U.S. PATENT DOCUMENTS**

- 3,548,809 A \* 12/1970 Conti ..... A61H 9/0078  
601/152
- 4,941,458 A \* 7/1990 Taheri ..... A61H 9/0078  
601/152
- D326,556 S \* 6/1992 Rooke ..... D2/911
- 5,218,954 A \* 6/1993 van Bemmelen .... A61H 9/0078  
128/DIG. 20

(Continued)

**OTHER PUBLICATIONS**

Recovery Pump Air Compression Boots, [site visited Apr. 21, 2022]. Available from Internet. URL: <https://www.herculife.com/rp-sports-compression-recovery-boots.html> (Year: 2017).\*

(Continued)

*Primary Examiner* — T Chase Nelson

*Assistant Examiner* — Kelly L Gross

(74) *Attorney, Agent, or Firm* — Vorys, Sater, Seymour and Pease LLP; Anthony P. Venturino; Maryellen Feehery Hank

(57) **CLAIM**

The ornamental design for a compression boot, as shown and described.

**DESCRIPTION**

FIG. 1 is a right side, front, and top perspective view of a compression boot showing the new design;  
 FIG. 2 is a left side, front, and top perspective view thereof;  
 FIG. 3 is a front view thereof;  
 FIG. 4 is a rear view thereof;  
 FIG. 5 is a bottom view thereof.  
 FIG. 6 is a top view thereof;  
 FIG. 7 is a left side view thereof; and  
 FIG. 8 is a right side view thereof;  
 FIG. 9 is another right side, front, and top perspective view of a compression boot showing the new design;  
 FIG. 10 is a left side, front, and top perspective view thereof;  
 FIG. 11 is a front view thereof;  
 FIG. 12 is a rear view thereof;  
 FIG. 13 is a bottom view thereof.  
 FIG. 14 is a top view thereof;  
 FIG. 15 is a left side view thereof; and,  
 FIG. 16 is a right side view thereof.

The broken lines along the seams of the compression boot depict stitching and form no part of the claimed design. The remaining broken lines are directed to portions of the compression boot that also form no part of the claimed design.

**1 Claim, 14 Drawing Sheets**

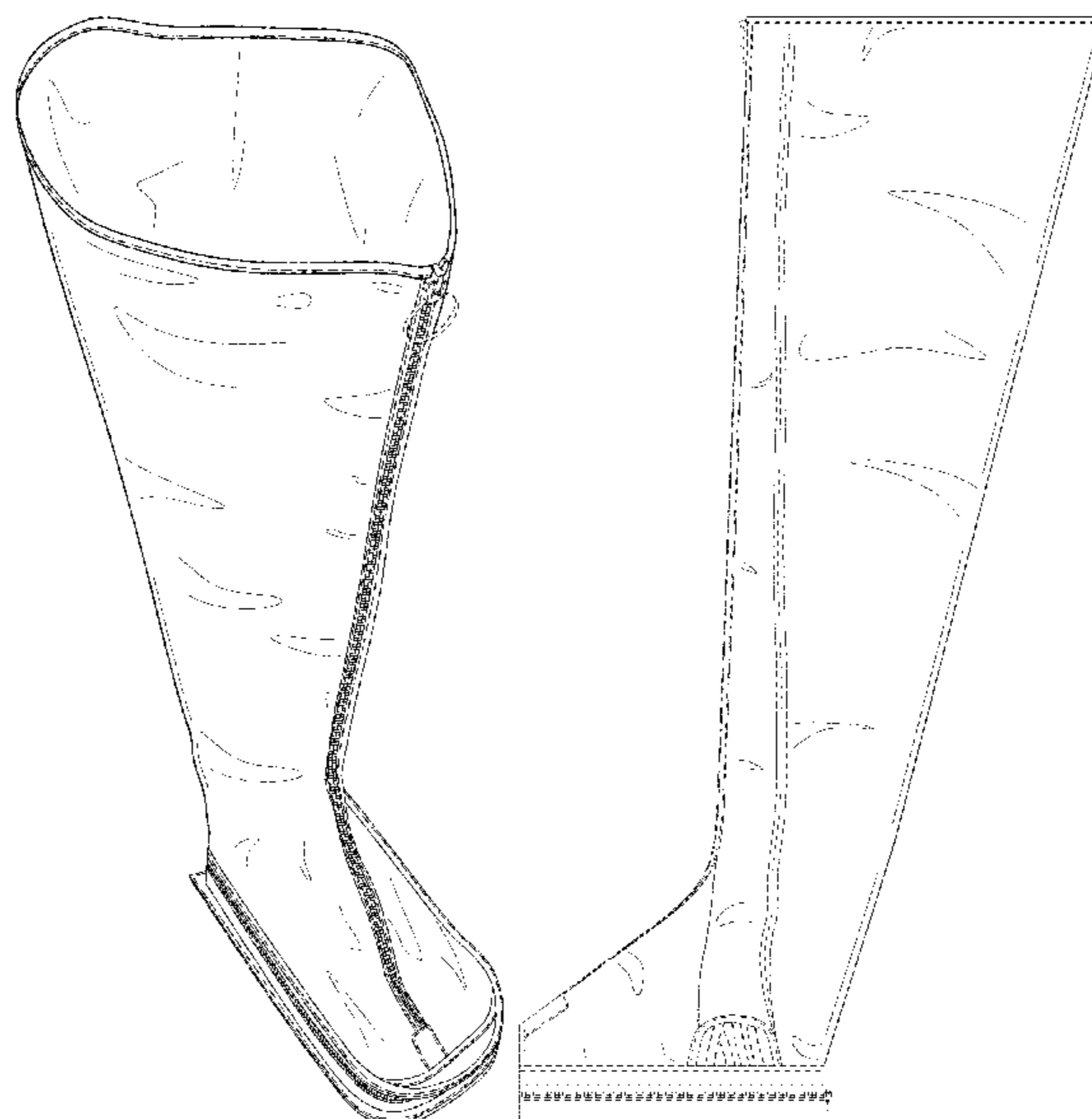

(56)

References Cited

U.S. PATENT DOCUMENTS

5,277,695 A \* 1/1994 Johnson, Jr. .... A61F 5/34  
 128/DIG. 20  
 D357,572 S \* 4/1995 Seiler ..... D2/910  
 D382,673 S \* 8/1997 Hargrove ..... D29/120.1  
 D382,994 S \* 9/1997 Kluttz ..... D2/980  
 D395,514 S \* 6/1998 Stano ..... D24/192  
 D433,758 S \* 11/2000 Allen ..... D24/207  
 6,254,554 B1 \* 7/2001 Turtzo ..... A61F 13/085  
 601/134  
 D477,413 S \* 7/2003 Schirmacher ..... D24/206  
 D483,876 S \* 12/2003 Walasek ..... D24/208  
 D505,727 S \* 5/2005 Krahner ..... D24/192  
 D530,016 S \* 10/2006 Sroufe ..... D24/192  
 D578,652 S \* 10/2008 Tabron ..... D24/192  
 D623,385 S \* 9/2010 Stansberry ..... D2/910  
 7,947,003 B2 \* 5/2011 Bonnefin ..... A61H 9/0078  
 601/150  
 D643,537 S \* 8/2011 Lee ..... D24/192  
 D686,738 S \* 7/2013 Tabron ..... D24/192  
 8,608,676 B2 \* 12/2013 Jorissen ..... A61F 5/05825  
 602/8  
 D747,601 S \* 1/2016 Middleton ..... D2/980  
 D756,076 S \* 5/2016 Branum ..... D2/910  
 D774,652 S \* 12/2016 Rego, Jr. .... D24/189  
 D798,463 S \* 9/2017 Crewdson ..... D24/192  
 D798,464 S \* 9/2017 Crewdson ..... D24/192  
 9,788,738 B2 \* 10/2017 Barak ..... A61H 9/0078  
 9,827,131 B2 \* 11/2017 Watts ..... A61F 5/0111  
 10,092,250 B2 \* 10/2018 Tucker ..... A61H 9/0078  
 10,226,211 B2 \* 3/2019 Barak ..... A61B 5/0205

D847,332 S \* 4/2019 Whiteside ..... D24/128  
 D848,625 S \* 5/2019 Chase ..... D24/190  
 10,350,104 B2 \* 7/2019 Wellendorf ..... A61F 5/0104  
 10,463,565 B2 \* 11/2019 Lowe ..... A61H 9/0092  
 D872,286 S \* 1/2020 Hoffman ..... D24/190  
 D872,288 S \* 1/2020 Zhang ..... D24/192  
 D872,291 S \* 1/2020 Ben-Noon ..... D24/200  
 D873,424 S \* 1/2020 Zhang ..... D24/192  
 D878,740 S \* 3/2020 Zeng ..... D2/980  
 D888,379 S \* 6/2020 Janek Marquez ..... D2/902  
 D888,969 S \* 6/2020 Zhang ..... D24/190  
 D893,734 S \* 8/2020 Hu ..... D24/192  
 10,813,825 B2 \* 10/2020 Schubert ..... A61H 9/0078  
 D904,619 S \* 12/2020 Spyropoulos ..... D24/169  
 D919,103 S \* 5/2021 MacPherson ..... D24/190  
 D921,207 S \* 6/2021 Chase ..... D24/190  
 D923,805 S \* 6/2021 Li ..... A61H 9/0078  
 D24/207  
 D965,284 S \* 10/2022 Papel ..... D2/980  
 D977,240 S \* 2/2023 Lan ..... D2/980  
 2002/0019657 A1 \* 2/2002 Elkins ..... A61F 7/02  
 602/14  
 2012/0179084 A1 \* 7/2012 Lipshaw ..... A61F 13/0273  
 602/75

OTHER PUBLICATIONS

Recovery Pump Air Compression Boots-Dated Review, [site visited Apr. 21, 2022]. Available from Internet. URL: <https://www.youtube.com/watch?v=bE--7J45ytl> (Year: 2017).\*

\* cited by examiner

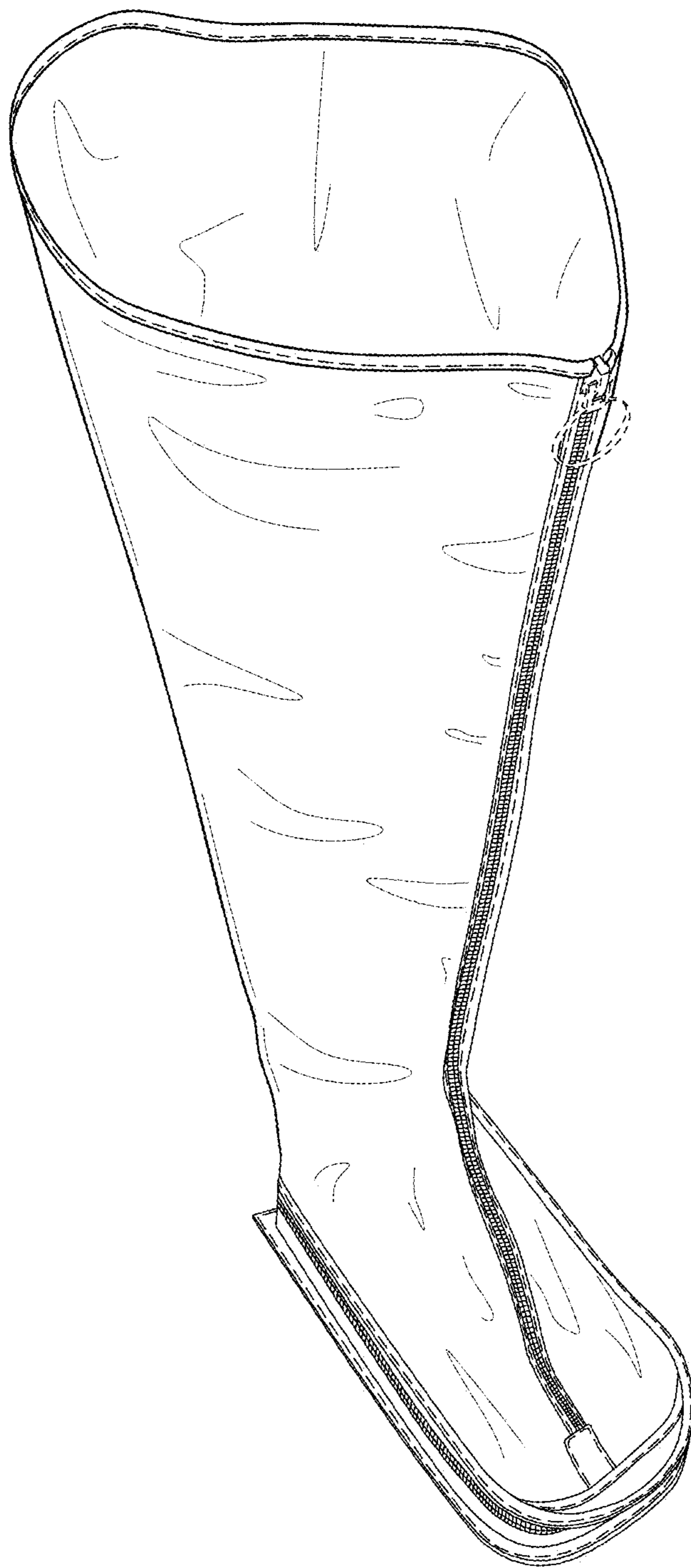

FIG. 1

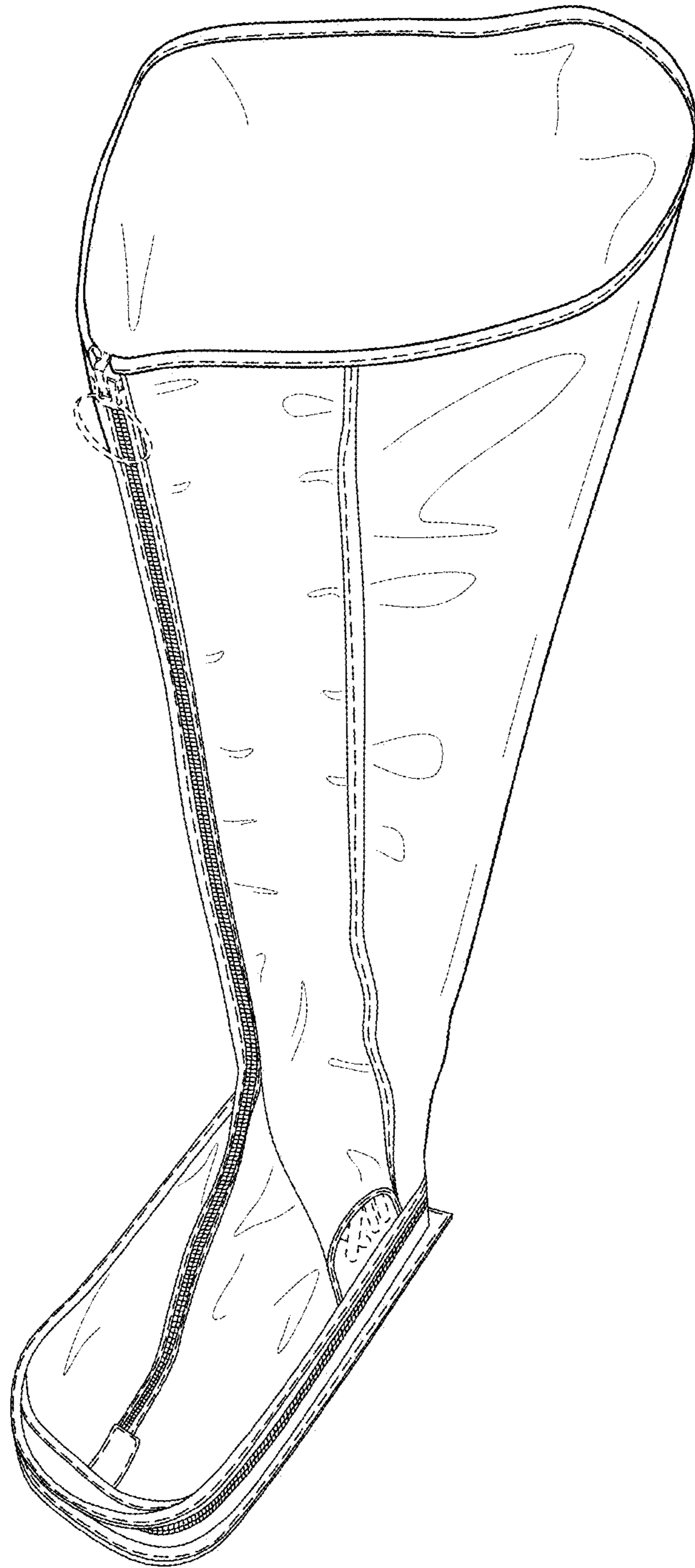

FIG. 2

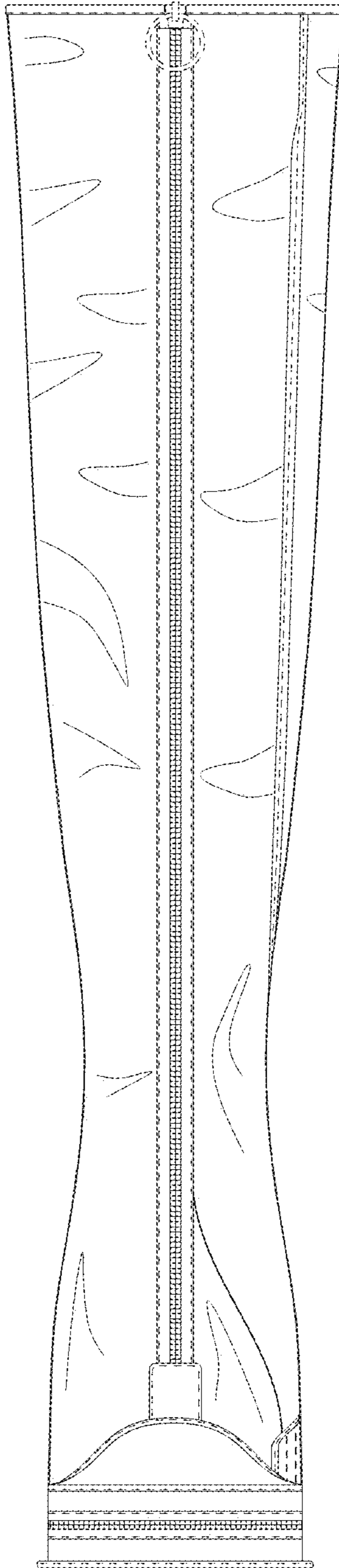

FIG. 3

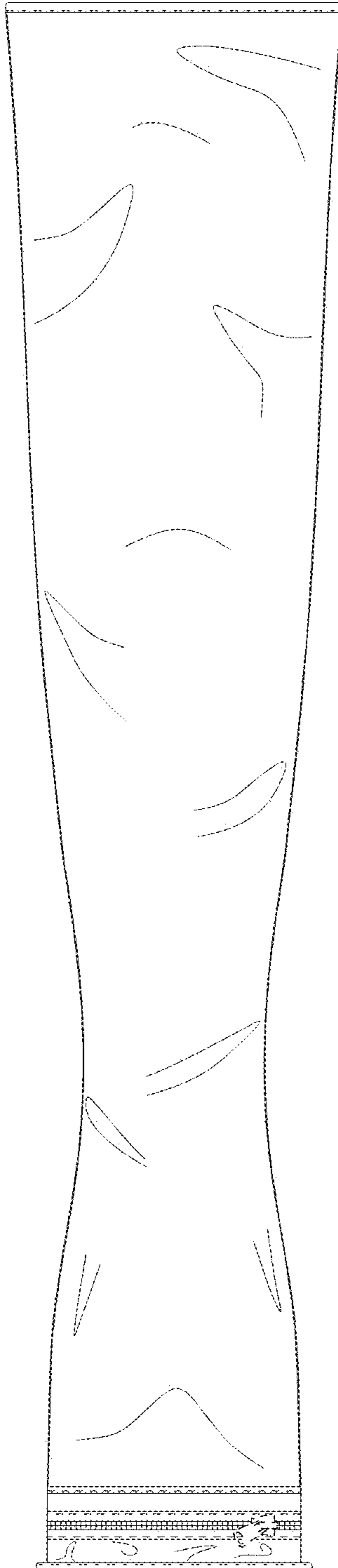

FIG. 4

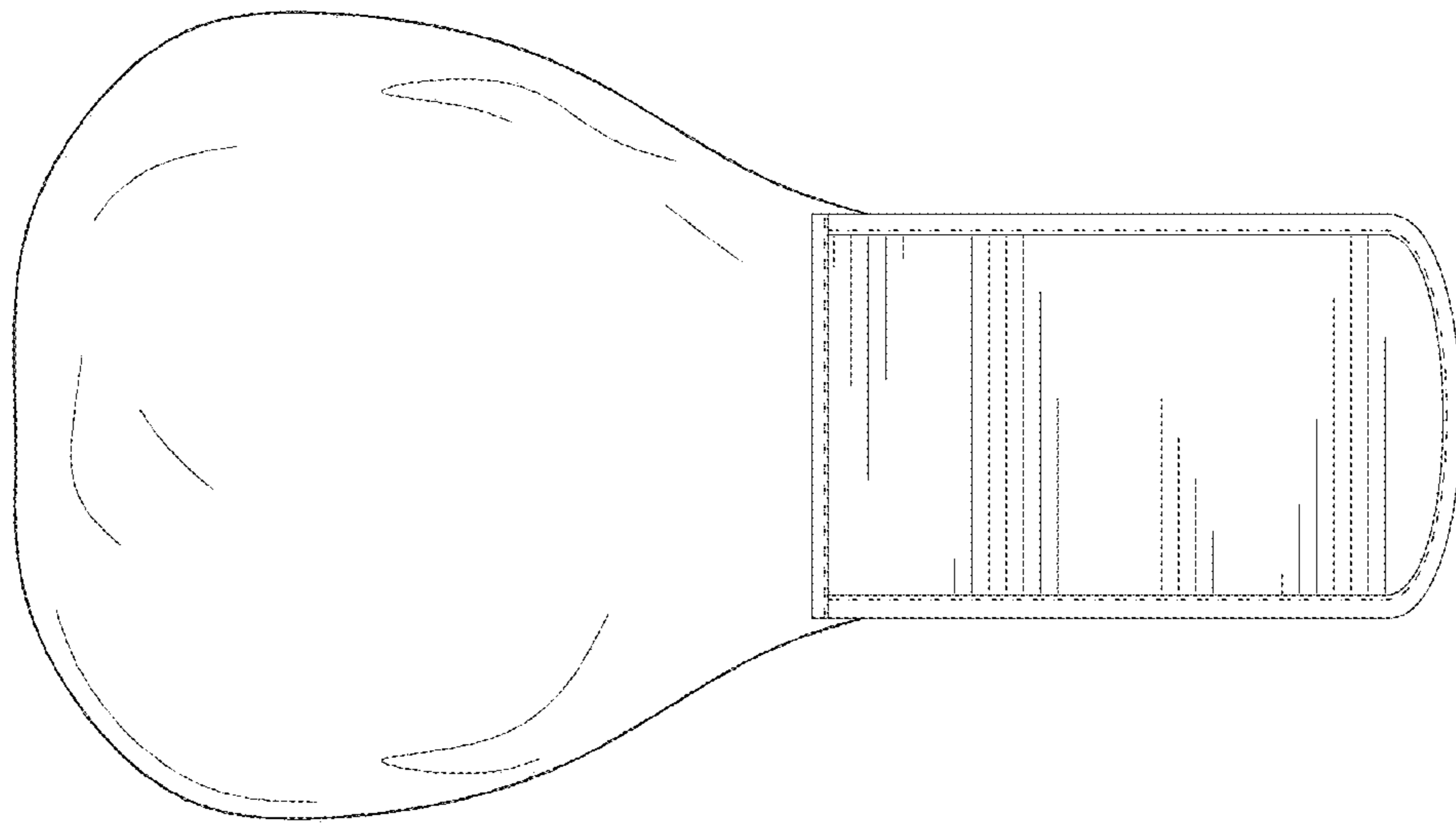

FIG. 5

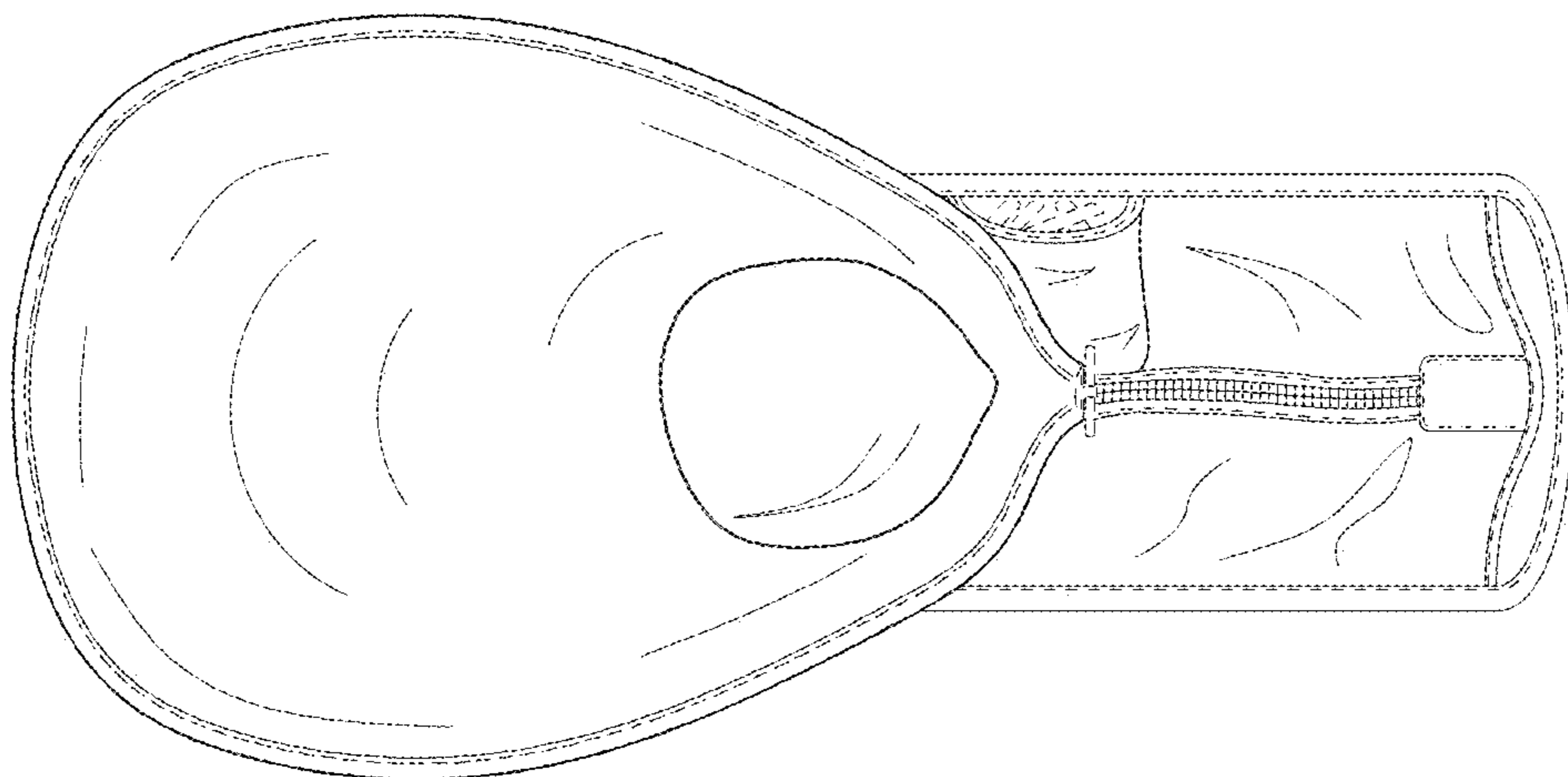

FIG. 6

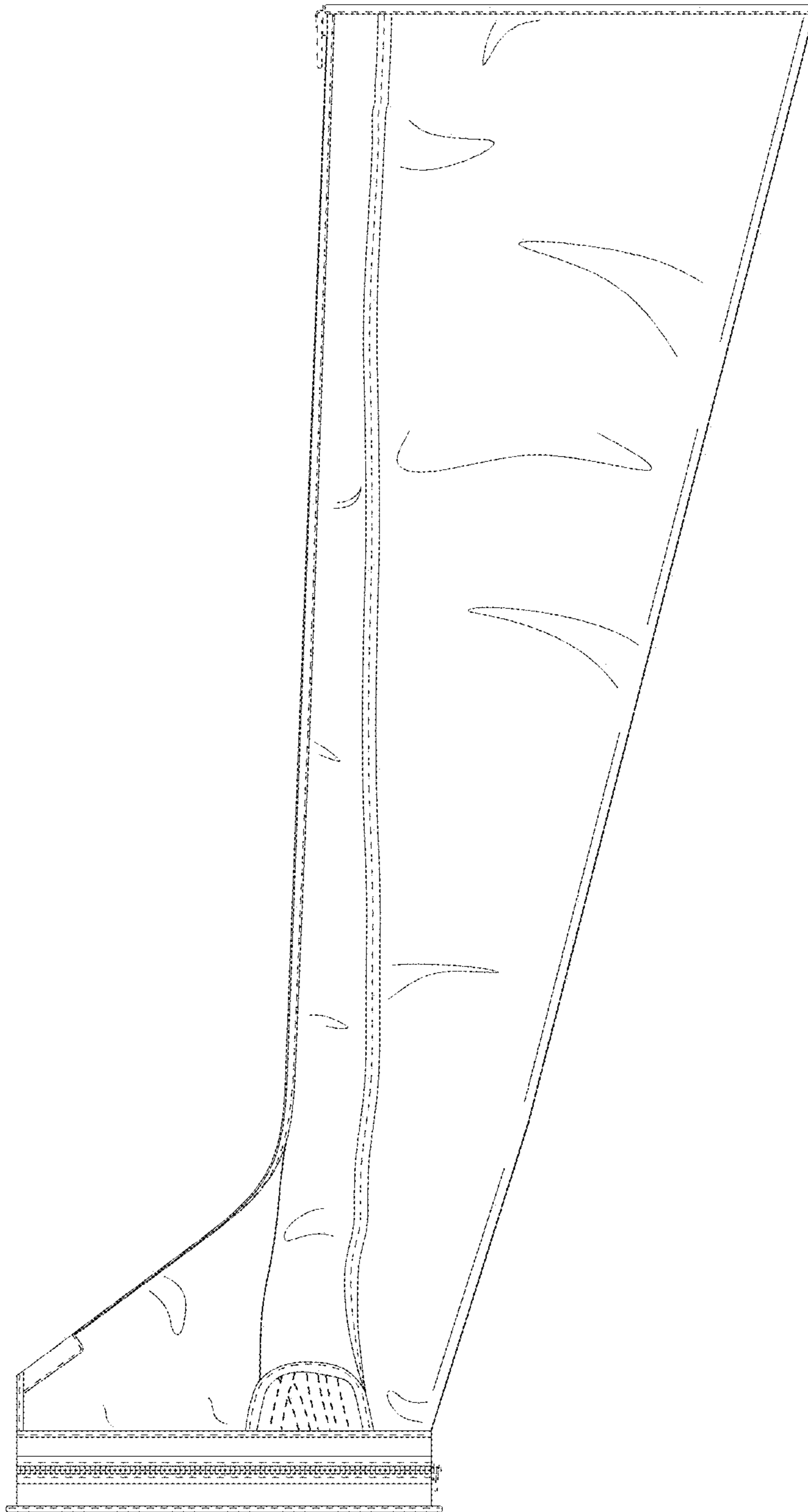

FIG. 7



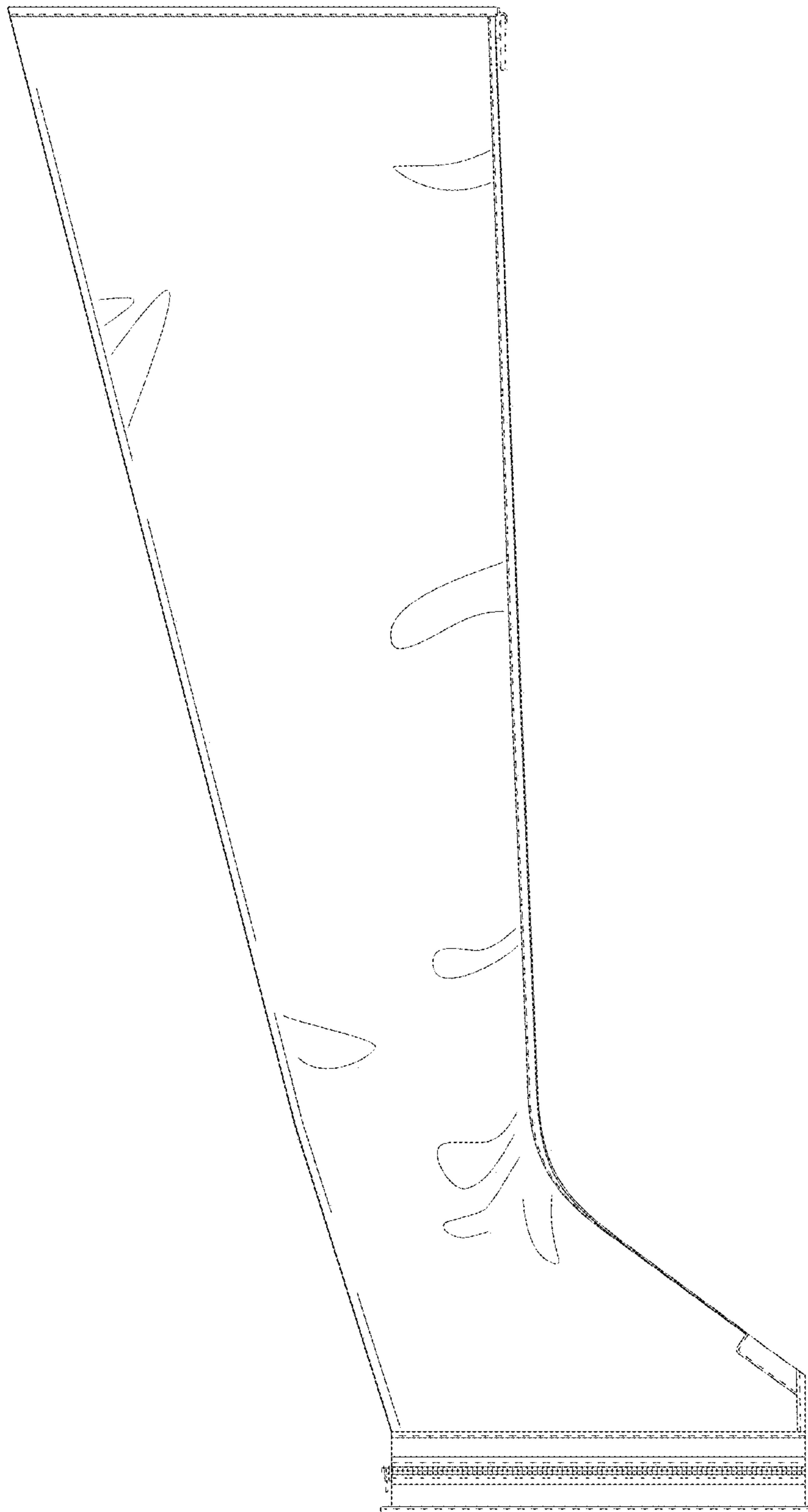

FIG. 8

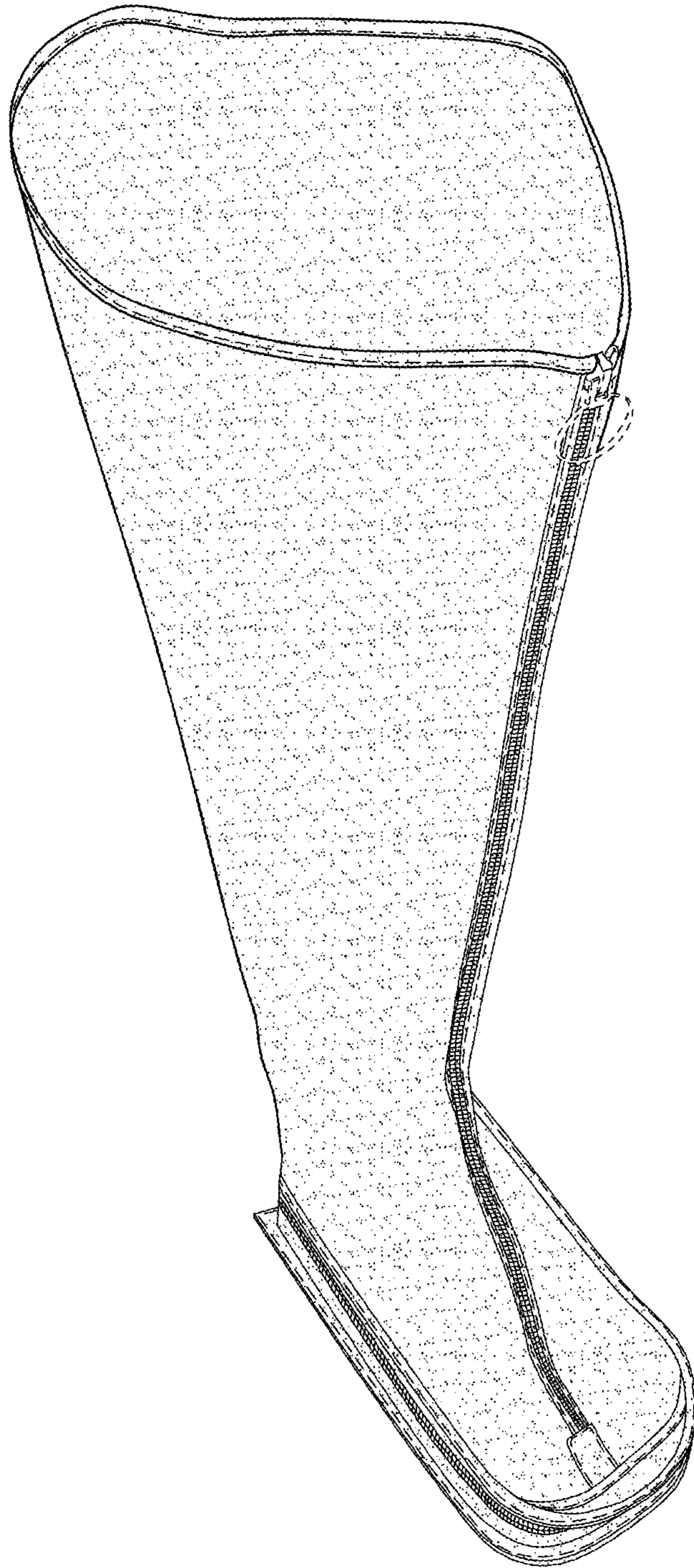

FIG. 9

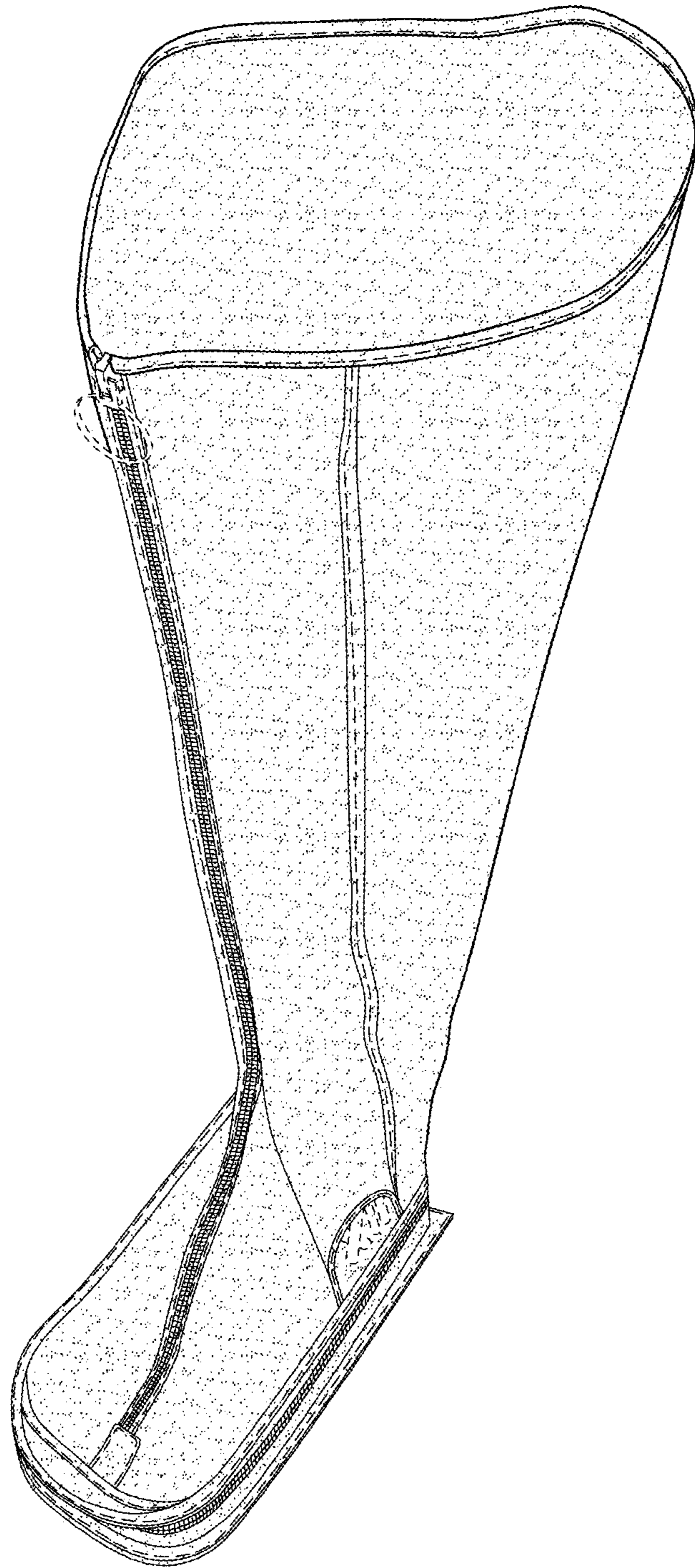

FIG. 10

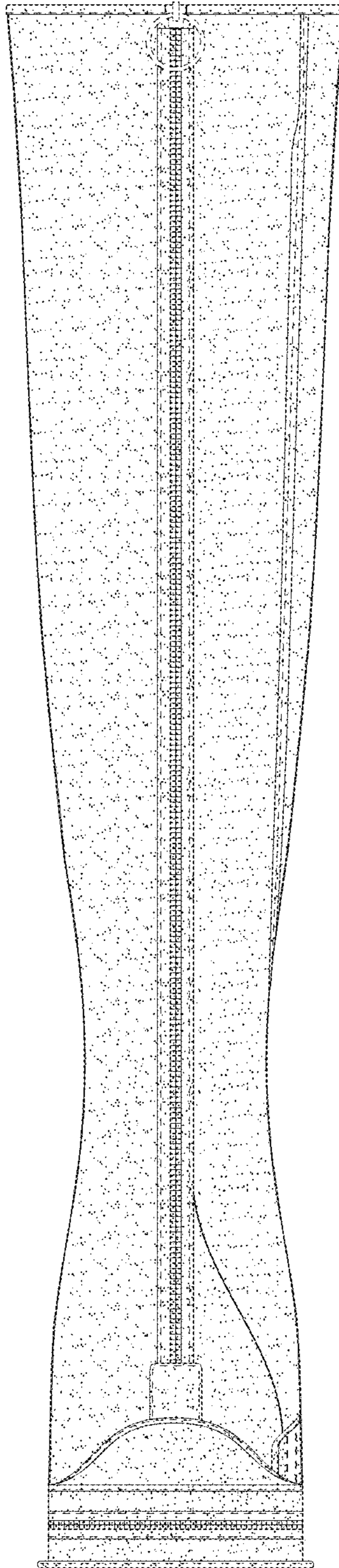

FIG. 11

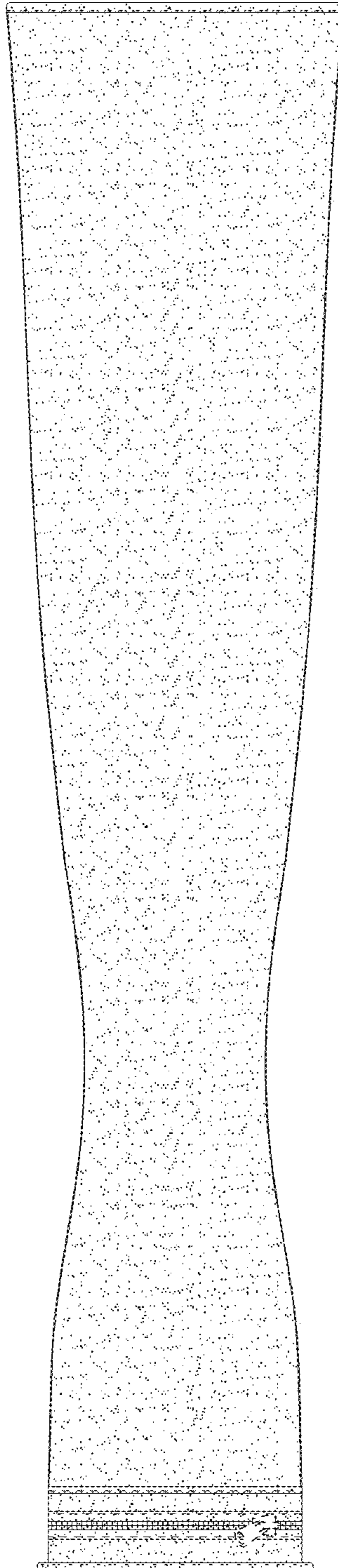

FIG. 12

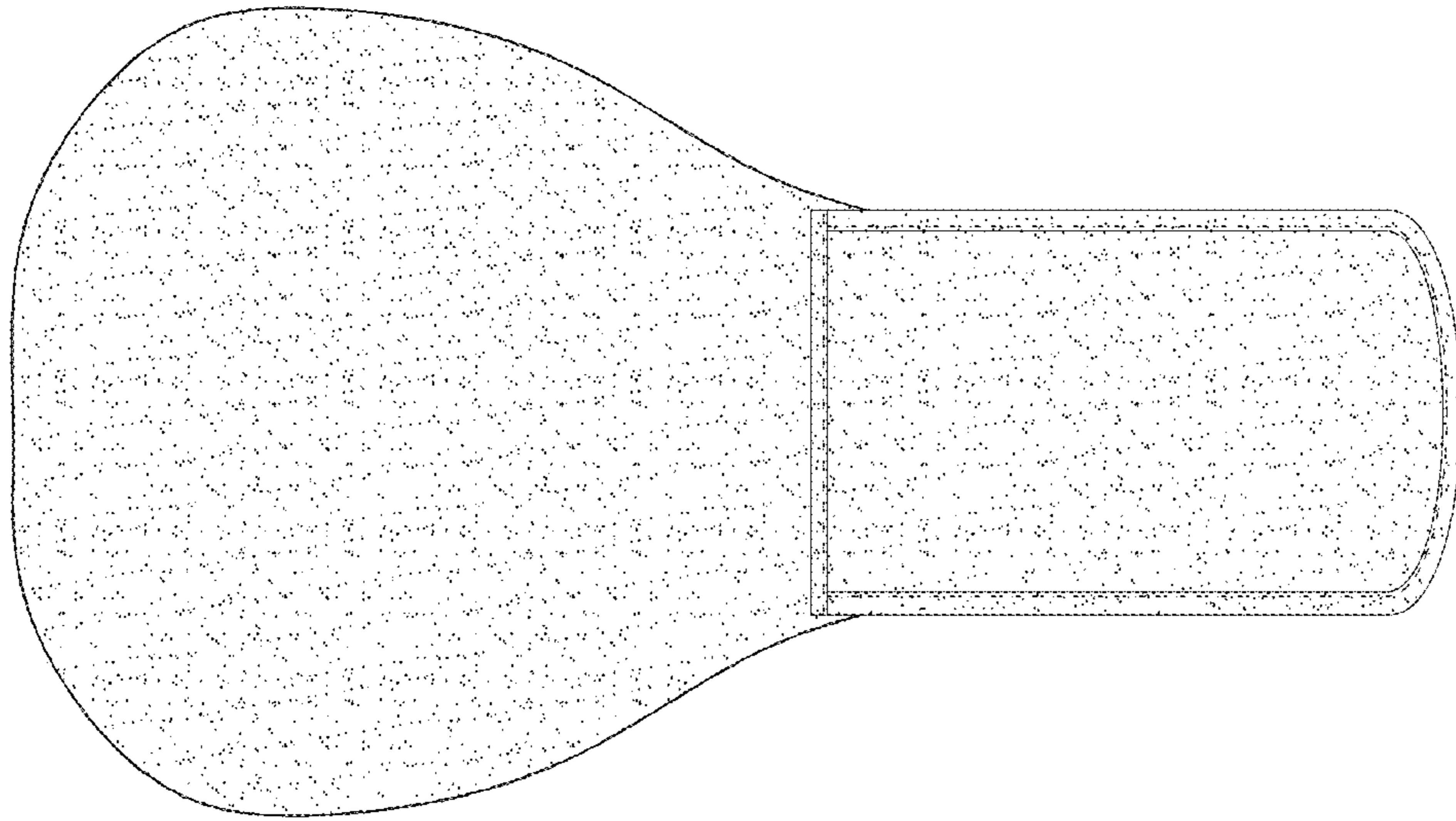

FIG. 13

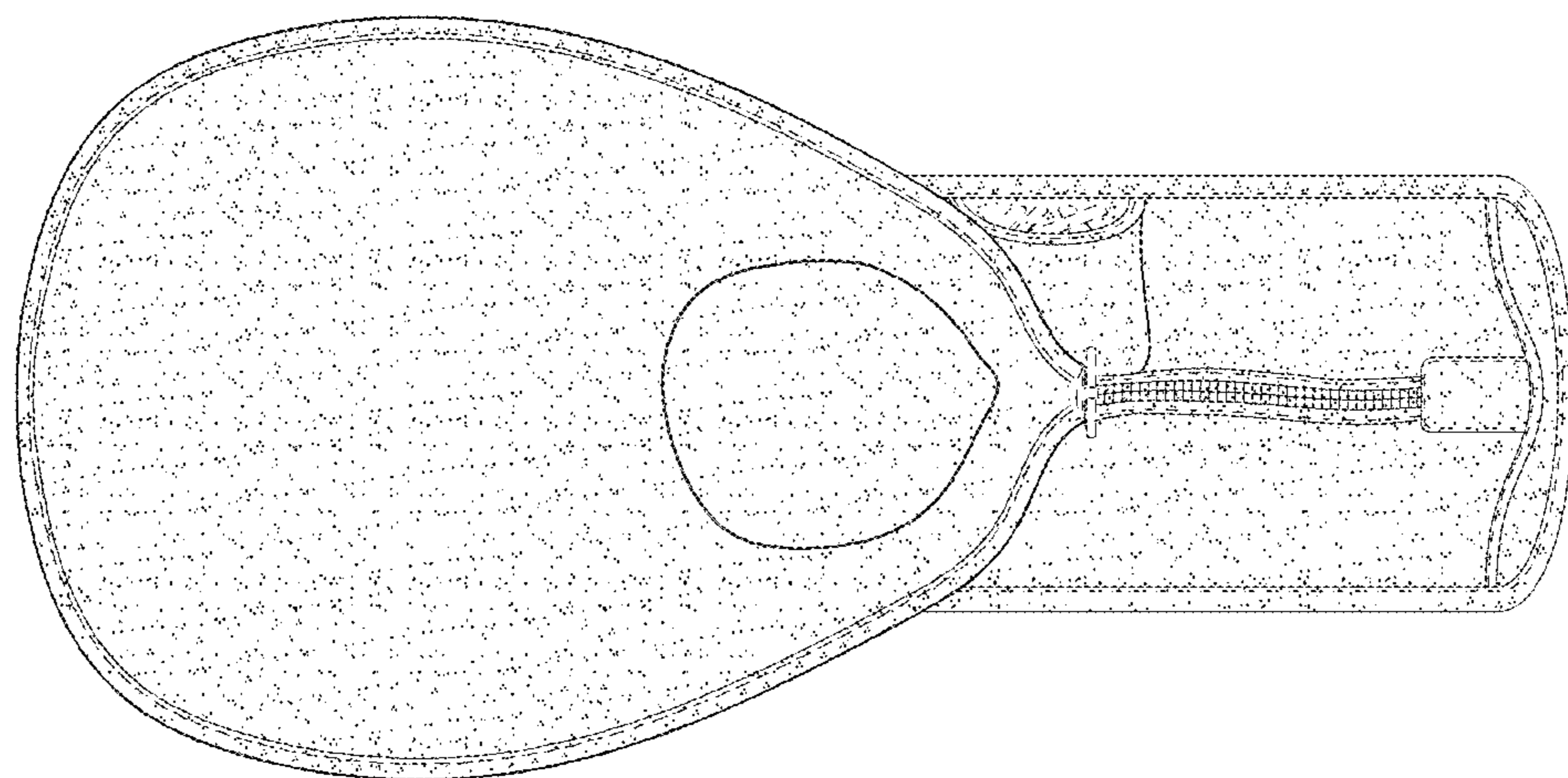

FIG. 14

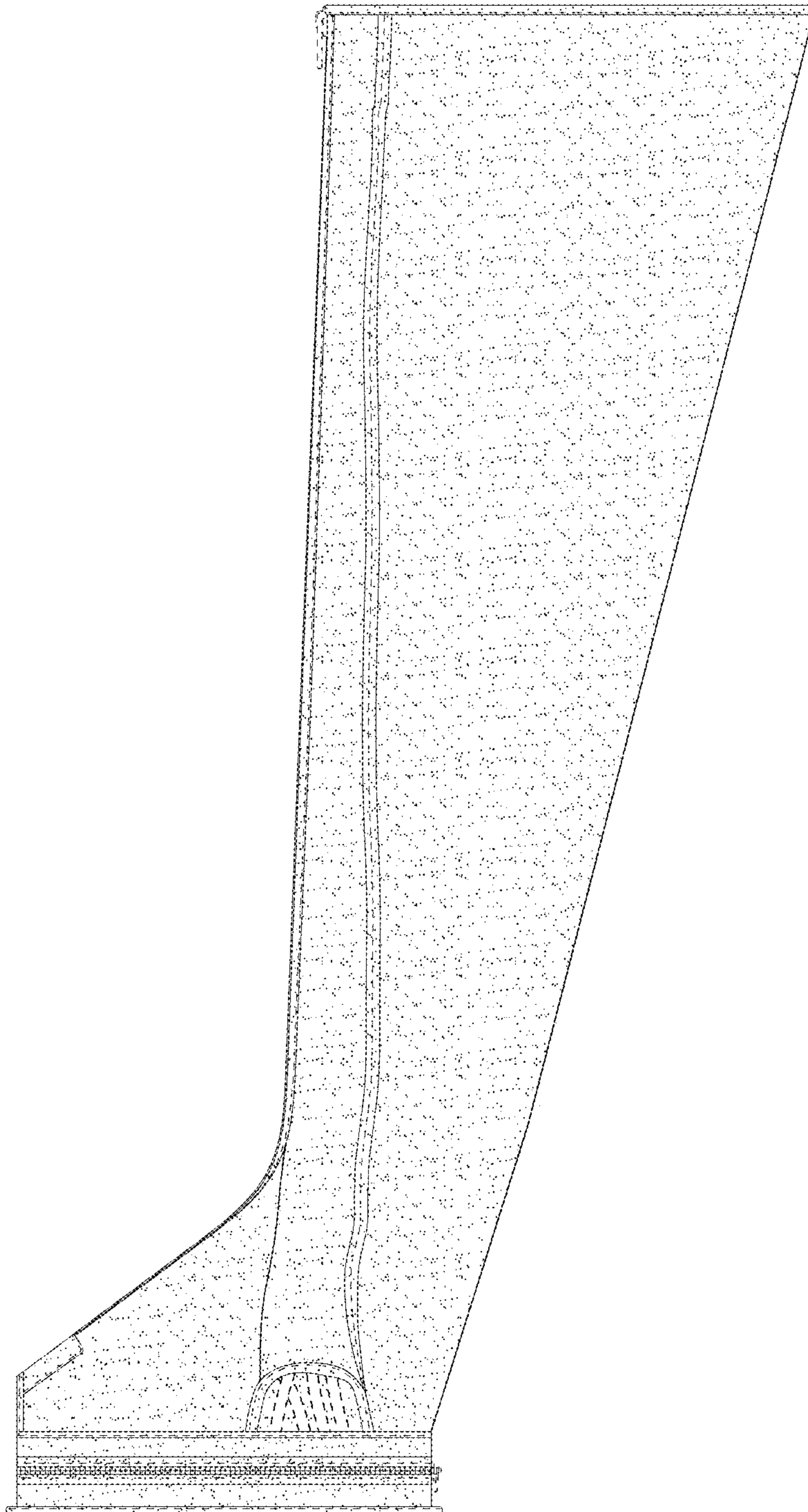

FIG. 15

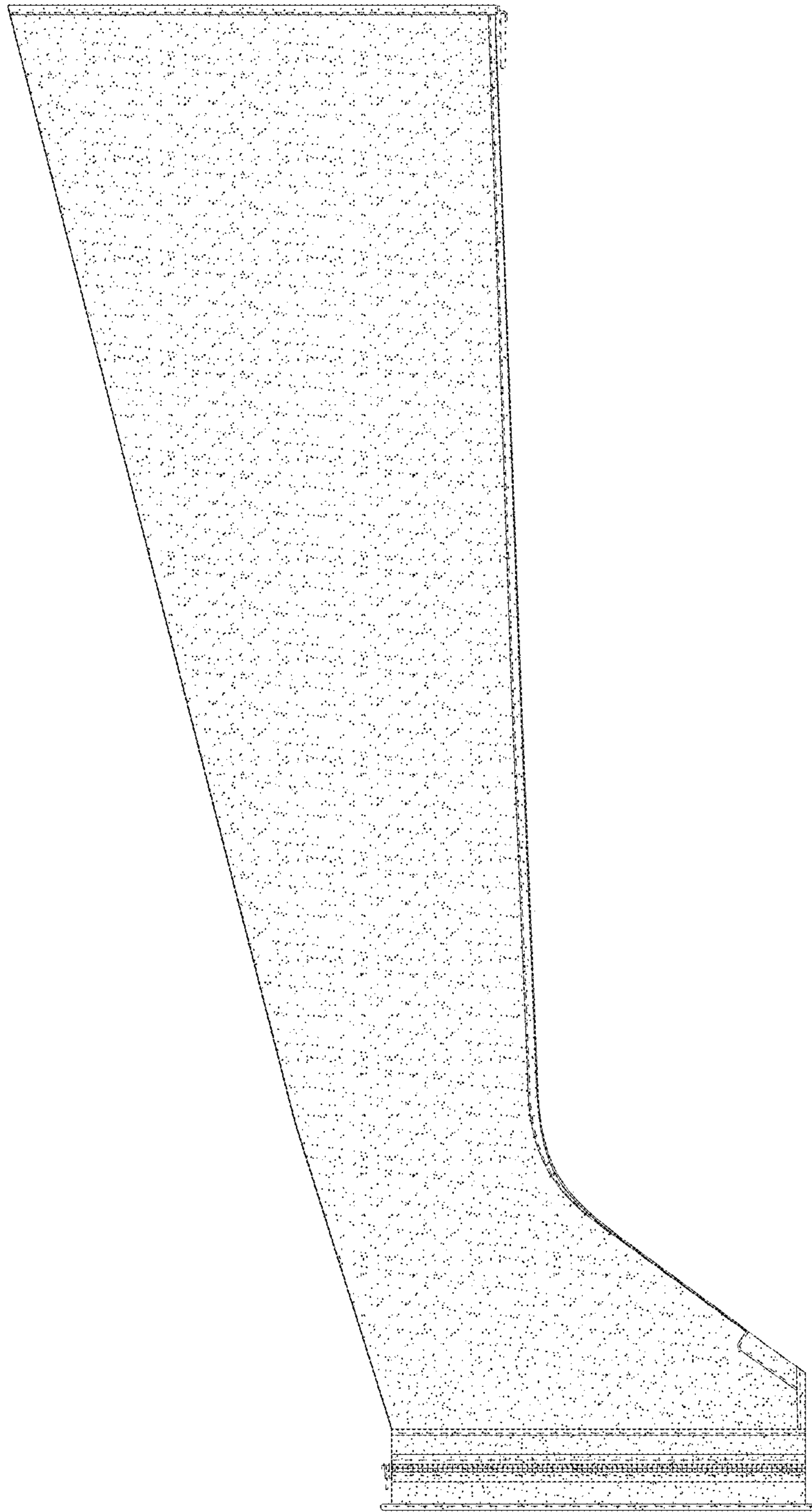

FIG. 16