

US00D986408S

(12) **United States Design Patent** (10) **Patent No.:** **US D986,408 S**
Zhang et al. (45) **Date of Patent:** **** May 16, 2023**

(54) **MASK**

FOREIGN PATENT DOCUMENTS

(71) Applicants: **Beijing Naton Medical Technology Holdings Co., Ltd.**, Beijing (CN); **Naton Medical Protective Equipment(Tianjin) Co., Ltd.**, Tianjin (CN)

CN 306061253 * 9/2020
CN 306355302 * 2/2021
EM 008311997-0002 * 12/2020

(72) Inventors: **Liang Zhang**, Beijing (CN); **Jianchun Lu**, Beijing (CN); **Zongwei Yu**, Beijing (CN); **Jian Wang**, Beijing (CN); **Xiang Dong**, Beijing (CN)

OTHER PUBLICATIONS

Gildan Adult Reusable 3-Layer Tie-On Face Mask. Jun. 10, 2020. Site visited Dec. 15, 2022. [https://www.amazon.com/Gildan-Adult-Reusable-3-Layer-Cotton/dp/B08BQYMT3Y/ref=sr_1_4?crd=39X5LSQHJJYJH&keywords=silicone+tie+back+mask&qid=1671134652&prefix=silicone+tie+back+mask%2Caps%2C87&sr=8-4] (Year: 2020).*

(73) Assignees: **BEIJING NATON MEDICAL TECHNOLOGY HOLDINGS CO., LTD.**, Beijing (CN); **NATON MEDICAL PROTECTIVE EQUIPMENT(TIANJIN) CO., LTD.**, Tianjin (CN)

(Continued)

Primary Examiner — Wendy L Arminio
Assistant Examiner — Maheen Khurshid
(74) *Attorney, Agent, or Firm* — Hodgson Russ LLP

(**) Term: **15 Years**

(21) Appl. No.: **29/761,643**

(57) **CLAIM**

(22) Filed: **Dec. 10, 2020**

The ornamental design for a mask, as shown and described.

(30) **Foreign Application Priority Data**

Jun. 12, 2020 (CN) 202030297162.2

(51) **LOC (14) Cl.** **29-02**

(52) **U.S. Cl.**
USPC **D24/110.1; D29/108**

(58) **Field of Classification Search**
USPC D24/110.1, 108, 110–110.4, 110.6, 162, D24/164; D29/102, 105–108, 110
(Continued)

DESCRIPTION

The file of this patent contains at least one drawing/photograph executed in color. Copies of this patent with color drawing(s)/photograph(s) will be provided by the Office upon request and payment of the necessary fee.

FIG. 1 is a front elevation view of a mask;
FIG. 2 is a rear elevation view thereof;
FIG. 3 is a left side elevation view thereof;
FIG. 4 is a right side elevation view thereof;
FIG. 5 is a top plan view thereof;
FIG. 6 is a bottom plan view thereof;
FIG. 7 is front perspective view thereof; and,
FIG. 8 is a rear perspective view thereof.

(56) **References Cited**

U.S. PATENT DOCUMENTS

5,699,792 A * 12/1997 Reese A41D 13/1184
128/207.11

D837,456 S * 1/2019 Andrews D29/108
(Continued)

1 Claim, 4 Drawing Sheets
(4 of 4 Drawing Sheet(s) Filed in Color)

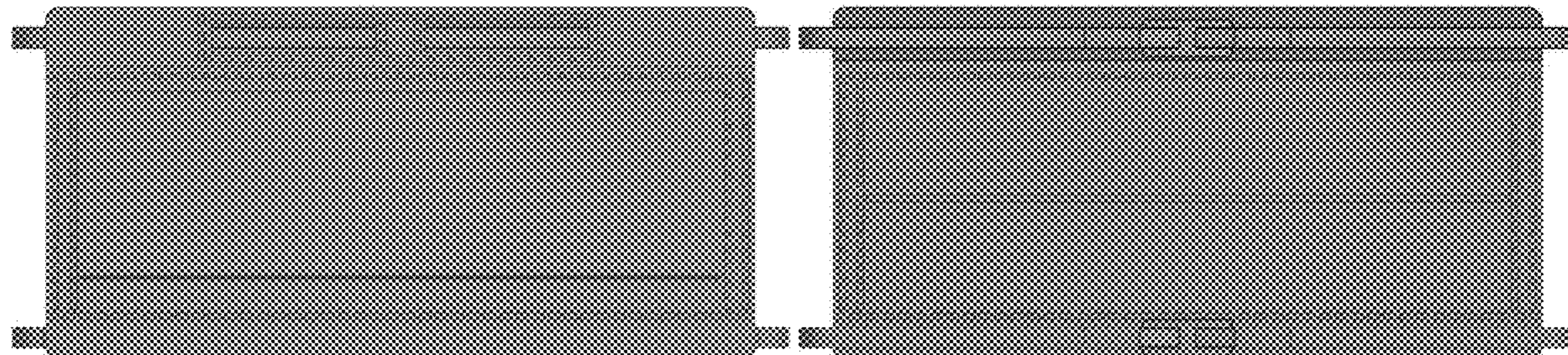

(58) **Field of Classification Search**

CPC A61M 16/00; A62B 7/00; A62B 18/00;
 A62B 18/02; A62B 18/025; A62B
 18/084; A62B 18/086; A62B 18/01; A62B
 18/04; A62B 18/08; A62B 23/00; A41D
 13/11; A41D 13/1107; A41D 13/1115;
 A41D 13/1123; A41D 13/113; A41D
 13/1161; A42B 3/20; A42B 3/225

See application file for complete search history.

(56) **References Cited**

U.S. PATENT DOCUMENTS

D848,678	S *	5/2019	Andrews	D29/108
D849,928	S *	5/2019	Grover	D24/110.1
D854,144	S *	7/2019	Bowen	D24/110.1
10,385,484	B1 *	8/2019	Wyrick	D04B 1/22
10,660,385	B2 *	5/2020	Nagao	A41D 13/1161
D905,351	S *	12/2020	Zheng	D29/108
11,052,269	B1 *	7/2021	Greenway, II	B01D 39/1623
D928,936	S *	8/2021	Zeng	D24/110.1
2009/0145434	A1 *	6/2009	Herrmann	A61M 16/06 128/203.29
2009/0205666	A1 *	8/2009	Bowen	A41D 13/1107 128/206.13
2011/0308525	A1 *	12/2011	Lu	A41D 13/1115 128/206.19
2012/0272973	A1 *	11/2012	Palomo	A41D 13/1115 128/863
2014/0076334	A1 *	3/2014	Cheng	A61B 46/00 128/857

2015/0306432	A1 *	10/2015	Orofino	A62B 18/025 29/505
2018/0160749	A1 *	6/2018	Kim	A41D 13/1107
2020/0229934	A1 *	7/2020	Song	A61F 2/3859

OTHER PUBLICATIONS

Defender Safety—ASTM Level 3 Face Mask. Aug. 12, 2020. Site visited Dec. 15, 2022. [https://www.amazon.com/Defender-Safety-Pleated-Tie-Back-Ply-30/dp/B08F5K7DHK/ref=sr_1_11?crid=39X5LSQHJJYJH&keywords=silicone+tie+back+mask&qid=1671134652&sprefix=silicone+tie+back+mask%2Caps%2C87&sr=8-11] (Year: 2020).*

Adjustable Mask Ear Strap Hook. Apr. 20, 2020. Site visited Dec. 15, 2022. [https://www.amazon.com/dp/B087BW6JC2/ref=sspa_dk_detail_3?psc=1&pd_rd_i=B087BW6JC2&pd_rd_w=dMybP&content-id=amzn1.sym.9f074495-da4d-4e1c-b407-69e85fa47fdb&pf_rd_p=9f074495-da4d-4e1c-b407-69e85fa47fdb&pf_rd_r=GXRKB6XS7MJYZJAEJ012&pd_rd_wg=jjeqn&pd_rd_r=b78d303b-b5fa-4266-8b8d-7f2dffdd145e&s=hpc&sp_csd=d2lkZ2V0TmFtZT1zcF9kZXRhaWxfidGhlbWF0aWM&spLa=ZW5jcnlwdGVkUXVhbGlmaWVyPUE0NVpXVU1IN1RLNUUmZW5jcnlwdGVkSWQ9QTEwMDgwMTkyM1Y5QjcxWE5FOTJJEJmVuY3J5cHRIZEFkSWQ9QTA4MjYzNTkyWDhQMfNlVfK2RVJBjndpZGldE5hbWU9c3BfZGV0YWIsX3RoZW1hdGljJmFjdGlvbj1jbGlja1JlZGlyZWNoJmRvTm90TG9nQ2xpY2s9dHJlZQ==] (Year: 2020).*

Mask Extender Strap. Sep. 2, 2020. Site visited Dec. 15, 2022. [https://www.amazon.com/Mask-Extender-Strap-Adjustment-Flexibility/dp/B08DXTTKVD/ref=sr_1_36?crid=3PPB3XNXY5MR5&keywords=surgical+snap+tie+back+mask&qid=1671134822&sprefix=surgical+snap+tie+back+mask%2Caps%2C101&sr=8-36] (Year: 2020).*

* cited by examiner

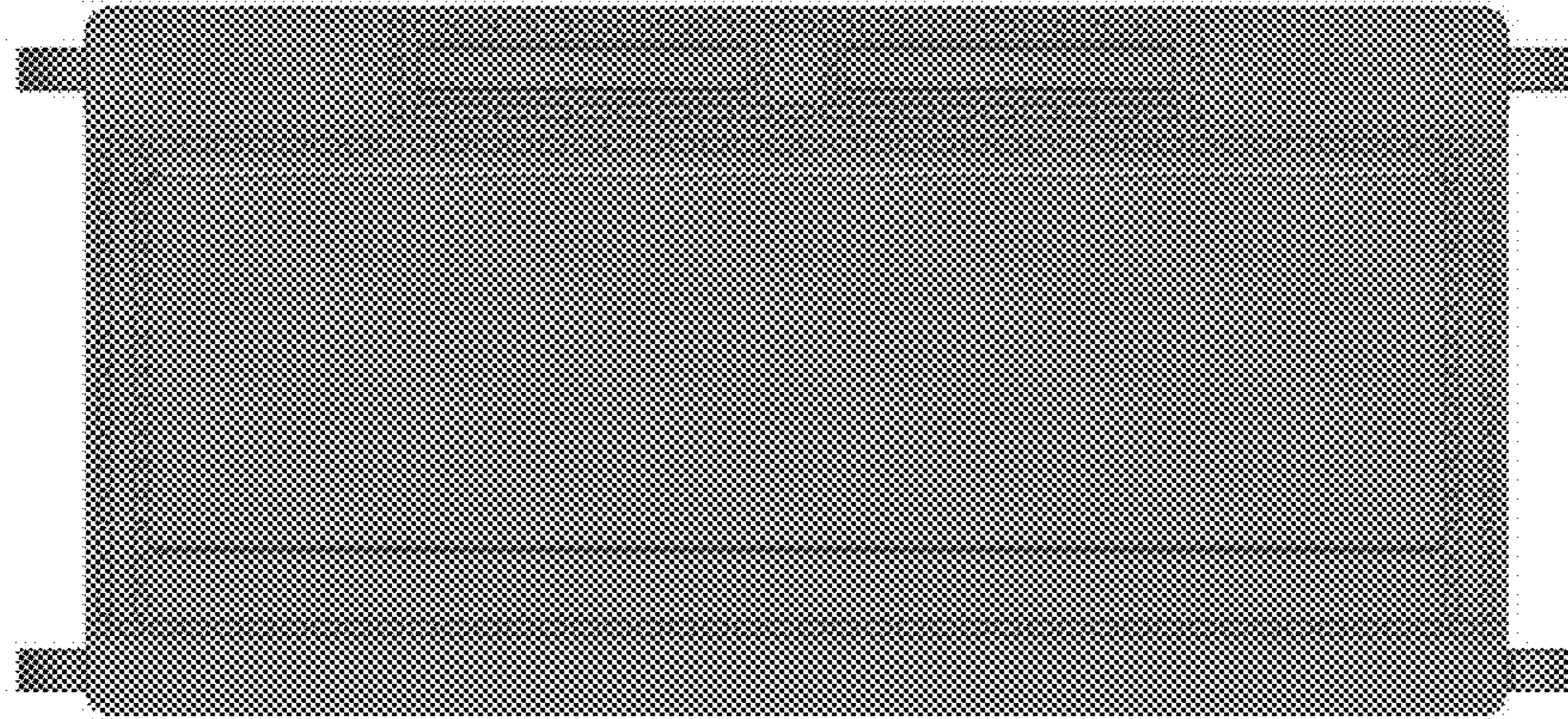

FIG. 1

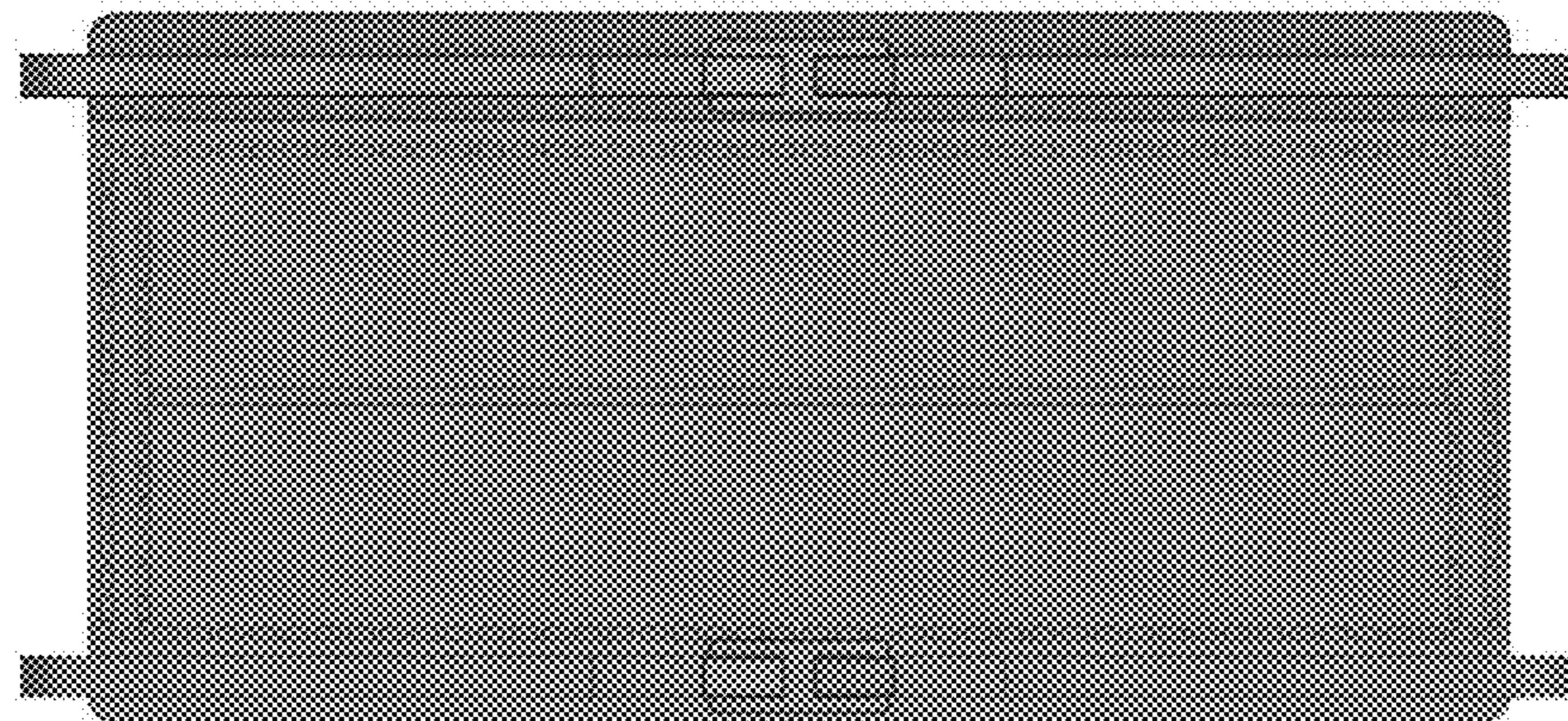

FIG. 2

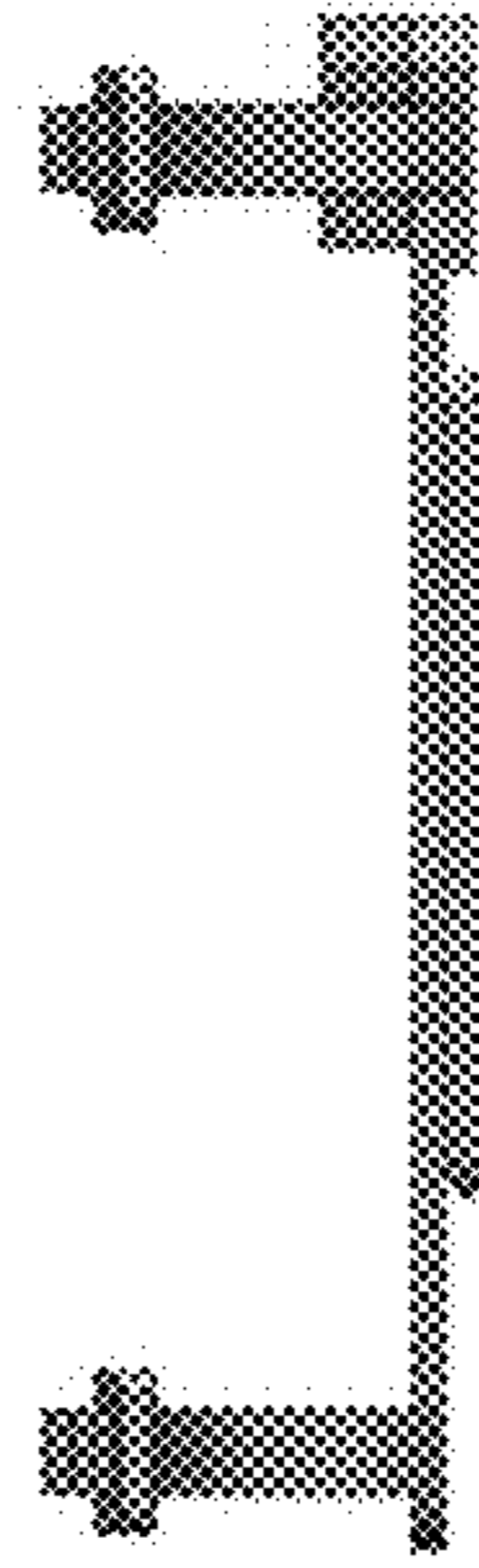

FIG. 3

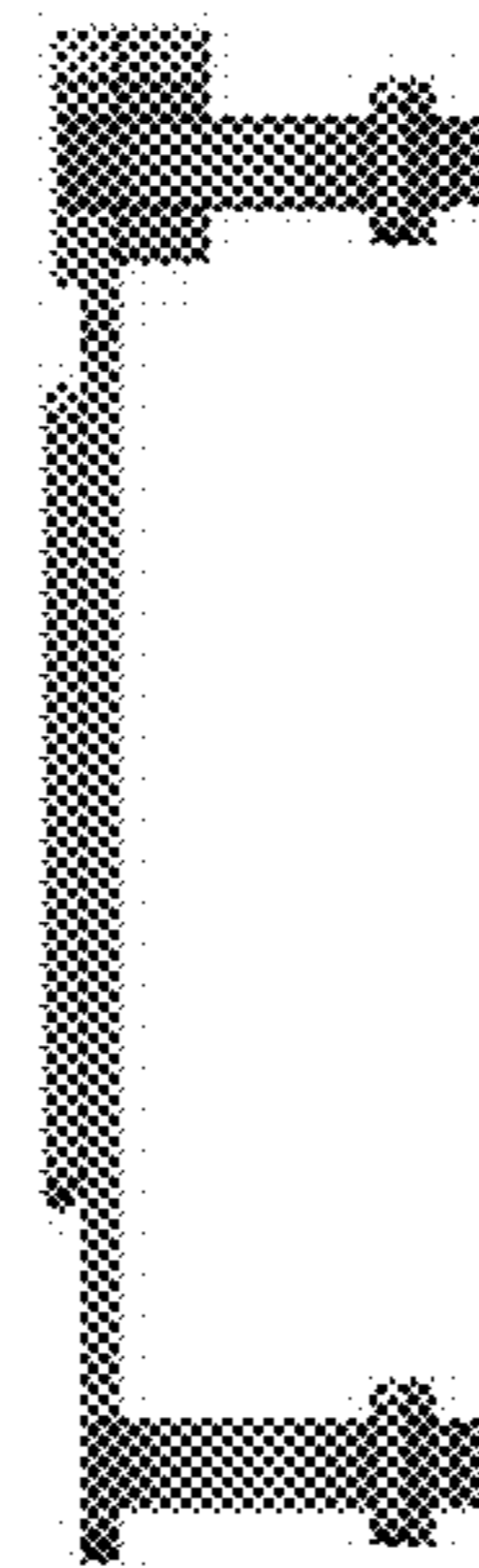

FIG. 4

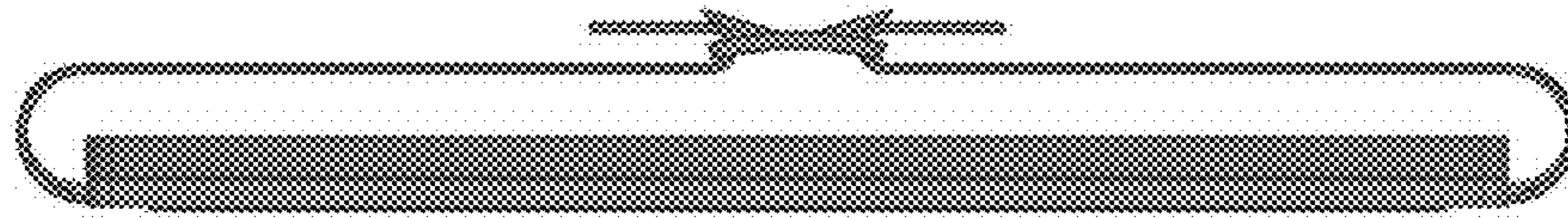

FIG. 5

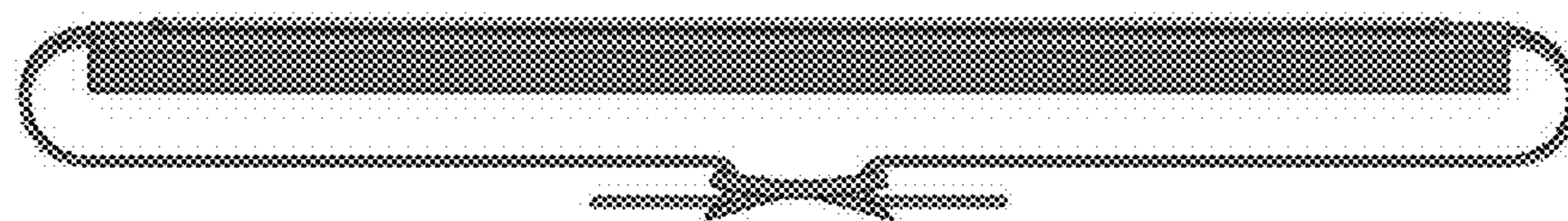

FIG. 6

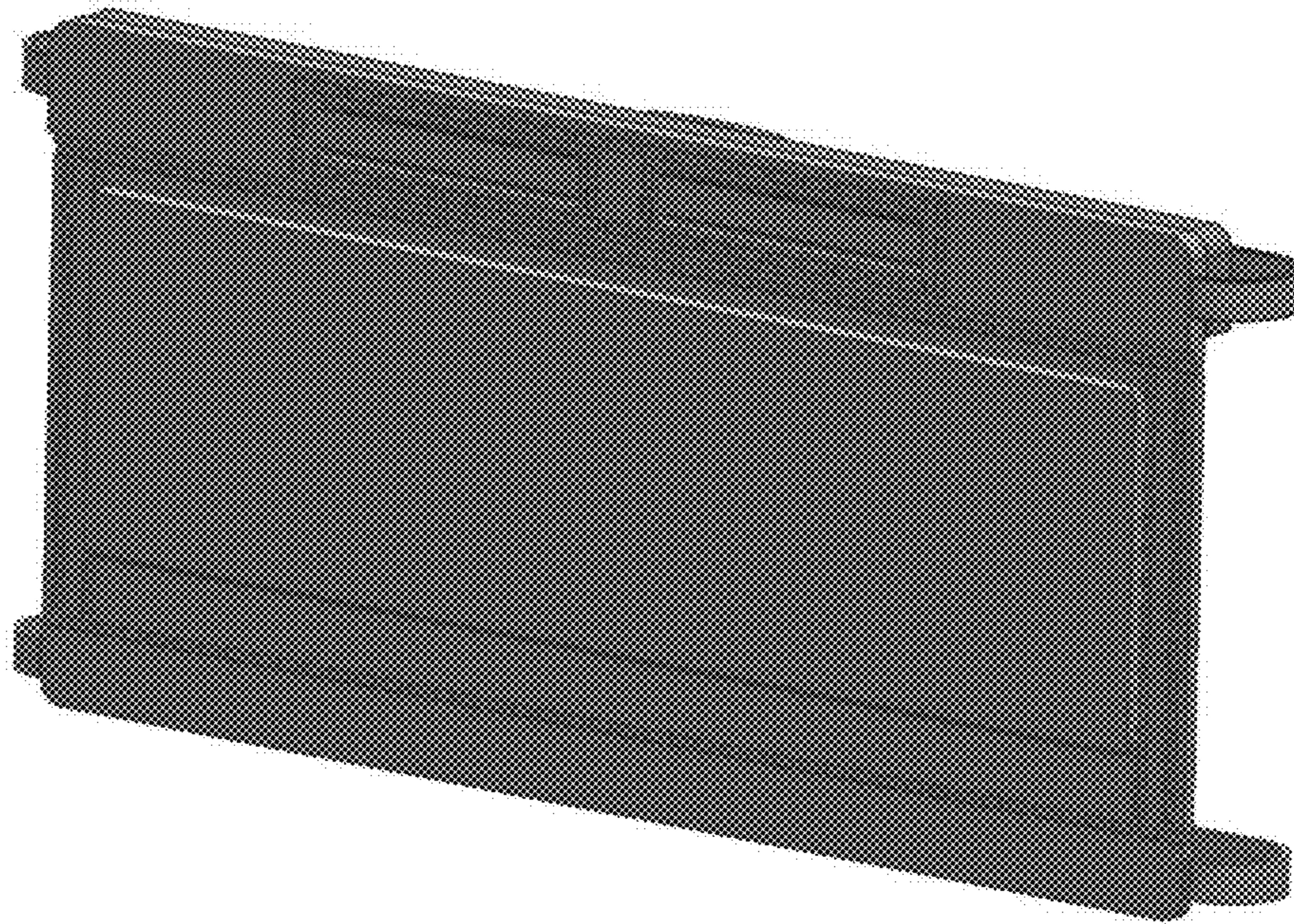

FIG. 7

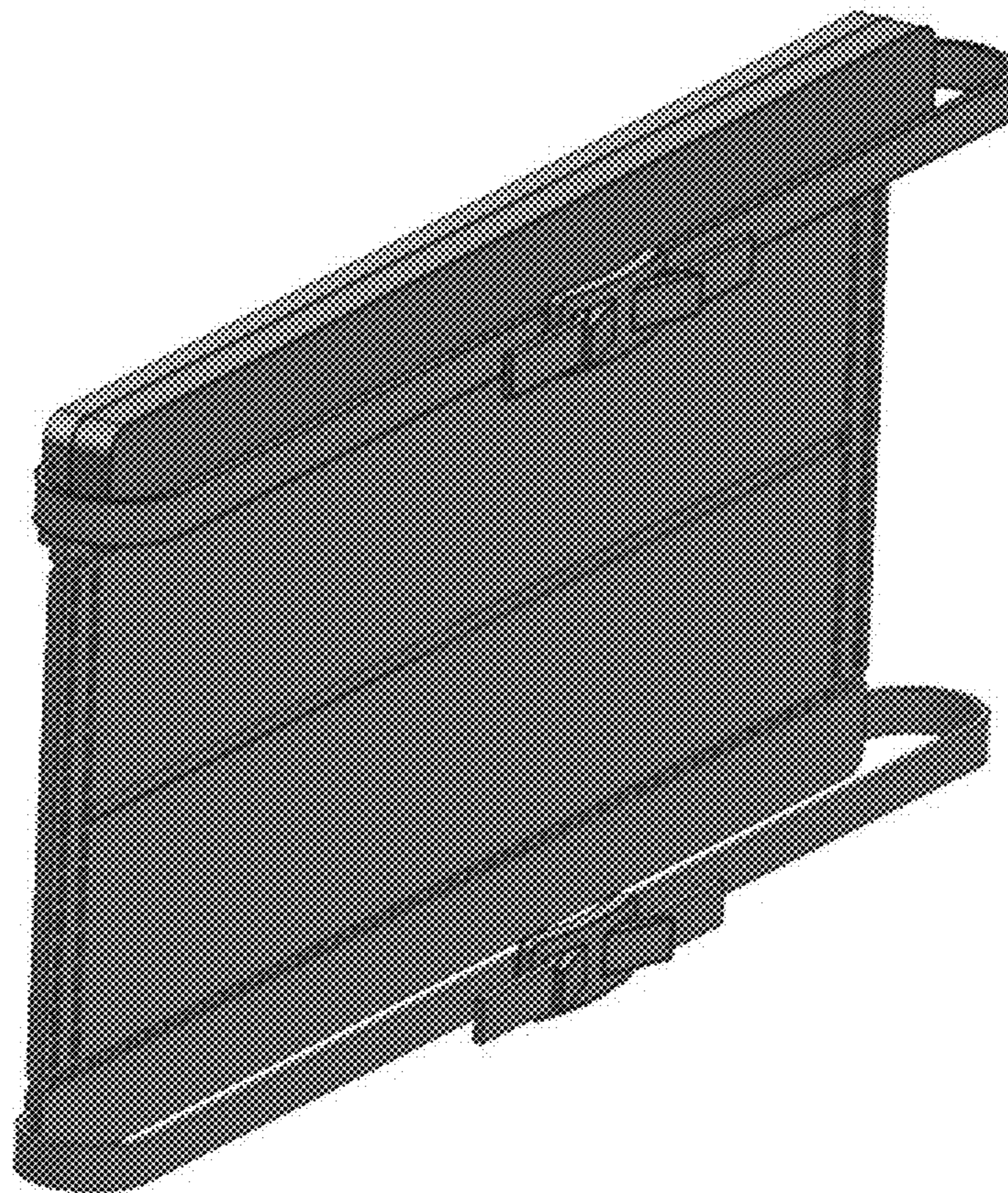

FIG. 8