



US00D986314S

(12) **United States Design Patent** (10) **Patent No.:** **US D986,314 S**
Yu (45) **Date of Patent:** **** May 16, 2023**

(54) **TELESCOPIC ROD**

(74) *Attorney, Agent, or Firm* — ScienBiziP, P.C.

(71) Applicant: **Shandong yijiale Smart Home Technology Co., Ltd.**, Longkou (CN)

(57) **CLAIM**

The ornamental design for a telescopic rod, as shown and described.

(72) Inventor: **Zengjie Yu**, Anhui (CN)

(73) Assignee: **Shandong yijiale Smart Home Technology Co., Ltd.**, Longkou (CN)

DESCRIPTION

(**) Term: **15 Years**

(21) Appl. No.: **29/848,865**

(22) Filed: **Aug. 5, 2022**

(30) **Foreign Application Priority Data**

Jul. 29, 2022 (EM) 009100753-0001
Jul. 29, 2022 (EM) 009100753-0002

(51) **LOC (14) Cl.** **16-06**

(52) **U.S. Cl.**
USPC **D16/132; D16/242**

(58) **Field of Classification Search**
USPC D16/200, 204, 208, 213–219, 235,
D16/237–250, 132; D14/209, 217, 224,
(Continued)

(56) **References Cited**

U.S. PATENT DOCUMENTS

D103,043 S * 2/1937 Carlson D8/DIG. 1
D194,592 S * 2/1963 Harris D16/242
(Continued)

OTHER PUBLICATIONS

JFIT Deluxe Pull-Up, Chin-Up, and Heavy Duty Bars with Padded Grips—Doorway or Wall Mount Assembly Options Available. Online, published date Jun. 3, 2013. Retrieved on Jan. 10, 2023 from URL: <https://www.amazon.com/JFIT-Deluxe-Pull-Up-Chin-Up-Padded/dp/B00D9Q7ZVY?th=1>.*

Primary Examiner — Omeed Agilee

1 Claim, 21 Drawing Sheets

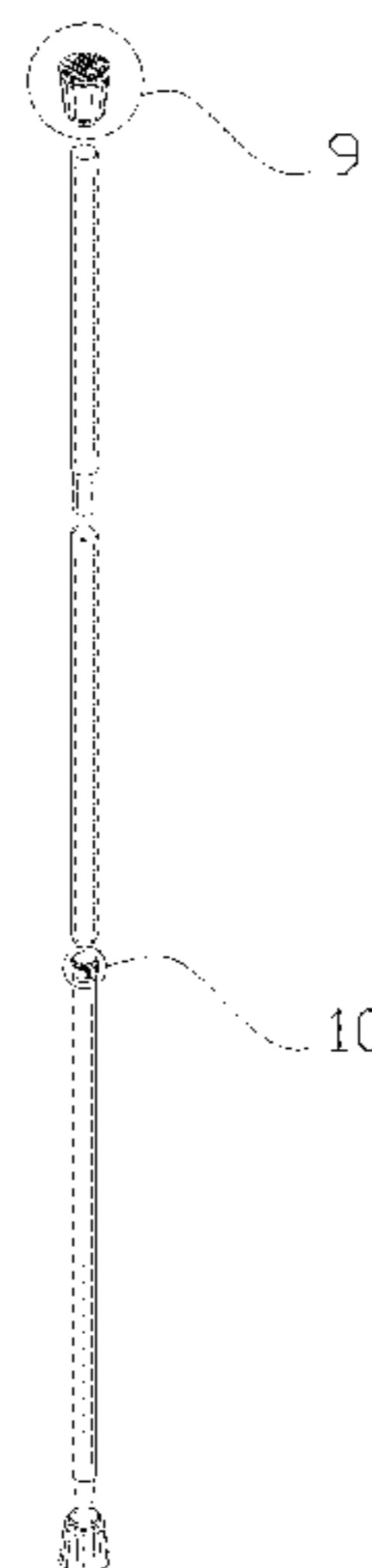

(58) **Field of Classification Search**

USPC D14/250–253, 345, 440, 449;
D8/300–303, 305, 363, 373, 394
CPC G03B 17/02; G03B 17/04; G03B 17/14;
G03B 21/20; G03B 21/20666; G03B
15/041–0436; F16M 11/32

See application file for complete search history.

(56) **References Cited**

U.S. PATENT DOCUMENTS

D194,593 S * 2/1963 Harris D16/242
D314,681 S * 2/1991 Reid D6/709.21
D561,274 S * 2/2008 Turner D21/679
D618,855 S * 6/2010 Messina D29/100
D663,306 S * 7/2012 Barbieri D14/452
D729,302 S * 5/2015 Reese D16/242
D779,755 S 2/2017 Balz et al.
D853,670 S 7/2019 Hu
D855,684 S * 8/2019 Glazer D16/242
D902,984 S * 11/2020 Ding D16/237
D904,533 S * 12/2020 Gilbert D21/679
D911,425 S * 2/2021 Shan D16/237
D930,090 S * 9/2021 Chen D21/679
D965,044 S * 9/2022 Patil D13/199
D972,053 S * 12/2022 Wang D21/679
D972,396 S * 12/2022 Chen D8/363
D973,756 S * 12/2022 Wang D16/244
2013/0117926 A1 * 5/2013 Parker A47H 1/022
4/610

* cited by examiner

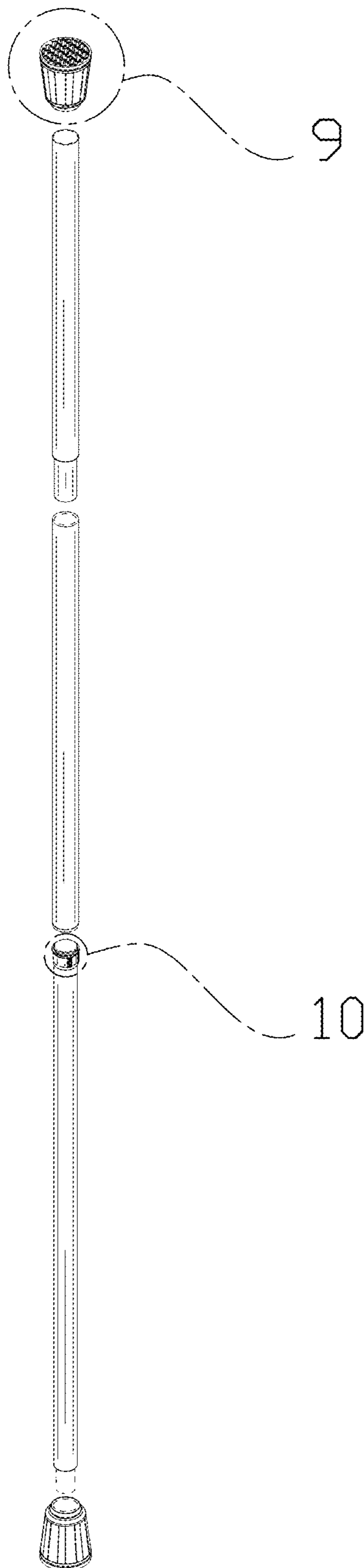

FIG. 1

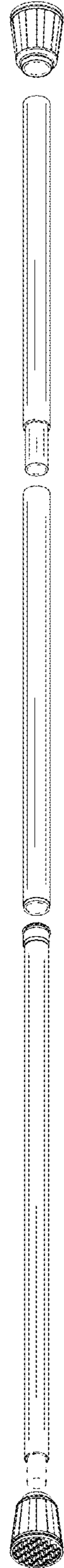

FIG. 2

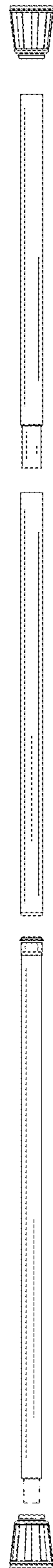

FIG. 3

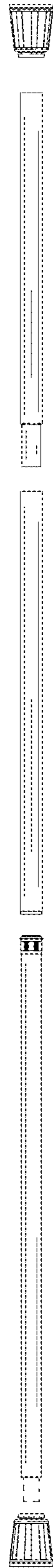

FIG. 4

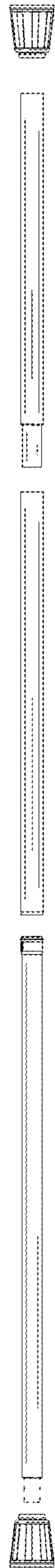

FIG. 5

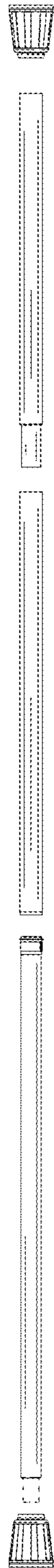

FIG. 6



FIG. 7



FIG. 8

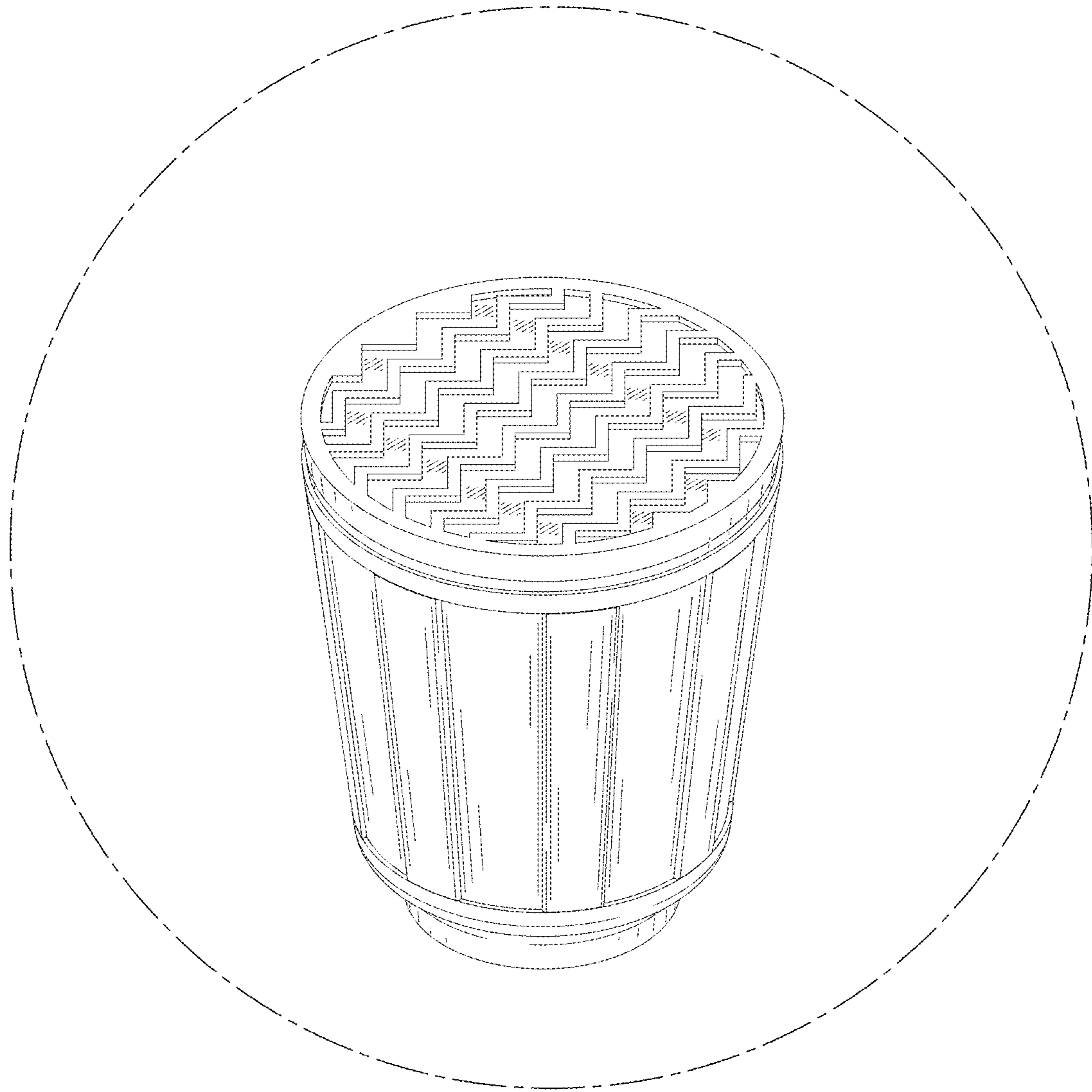

FIG. 9

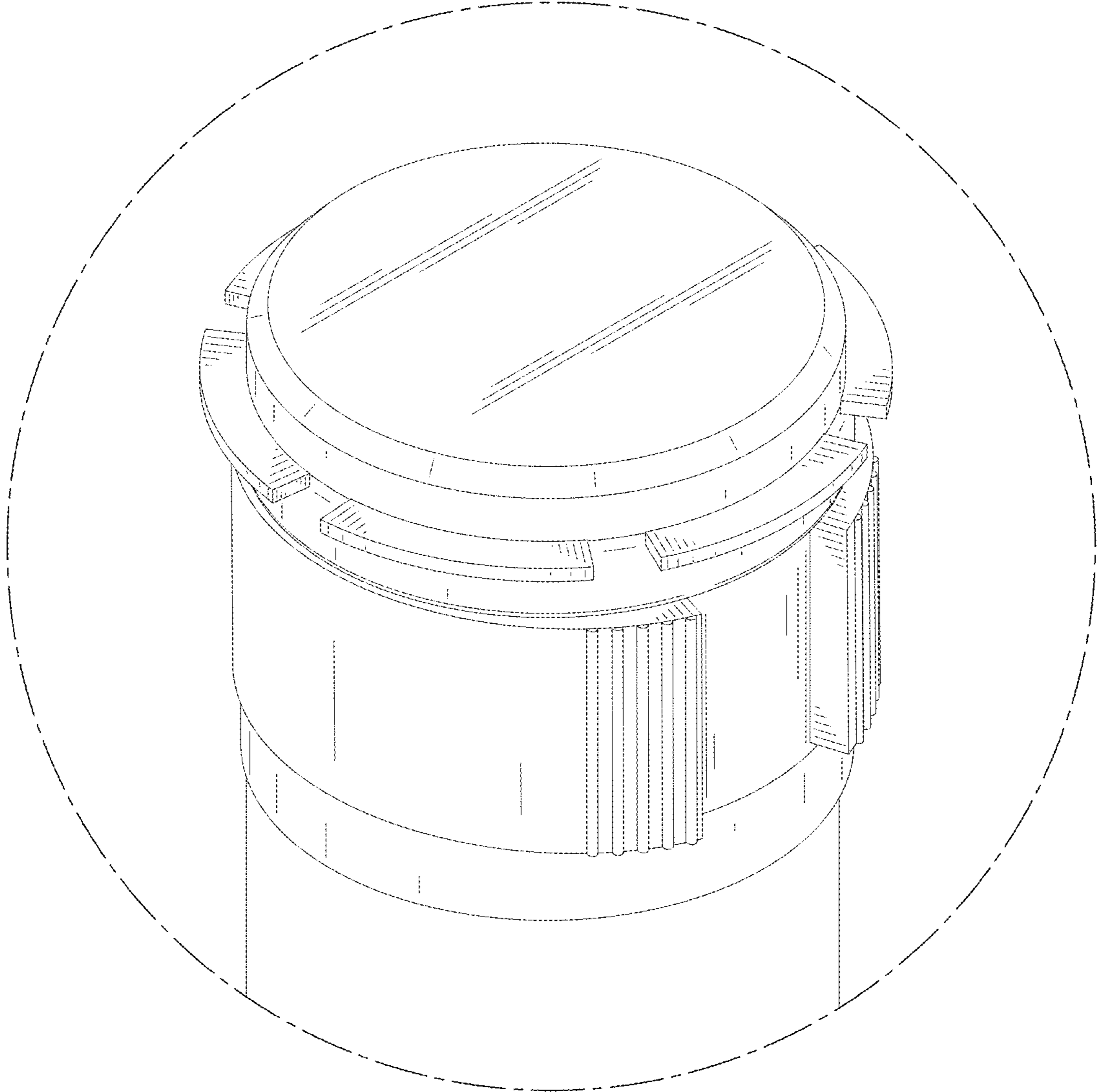

FIG. 10

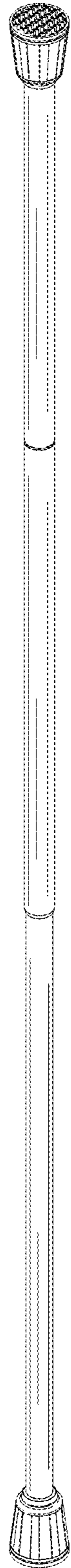

FIG. 11

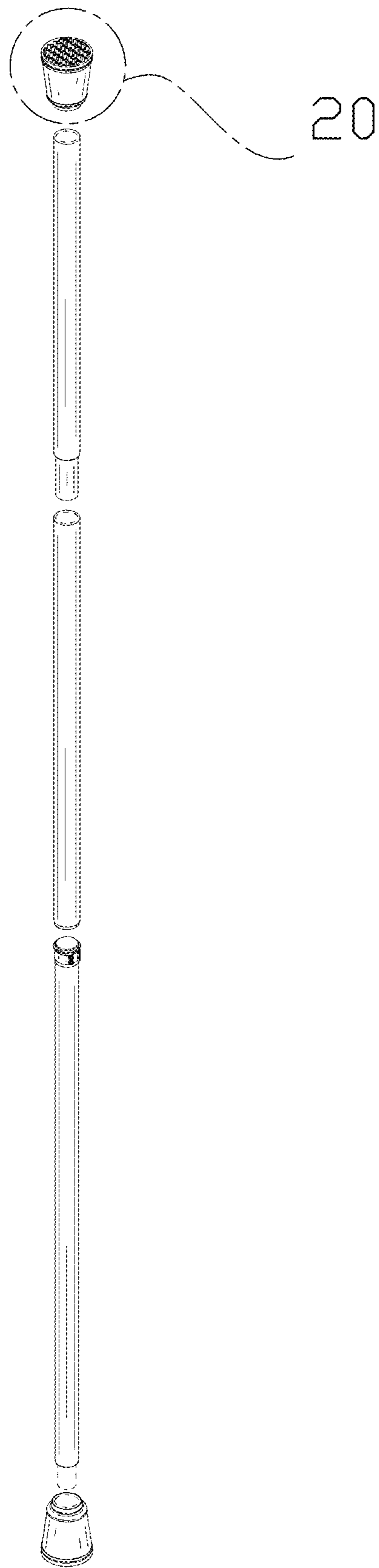

FIG. 12

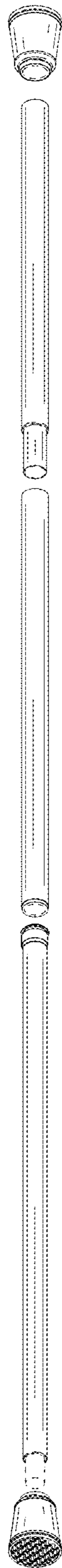

FIG. 13

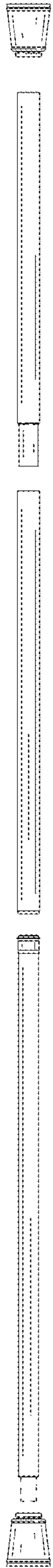

FIG. 14

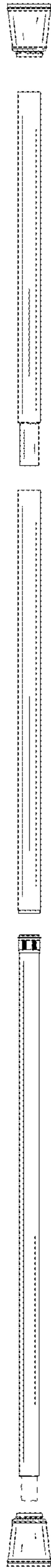

FIG. 15

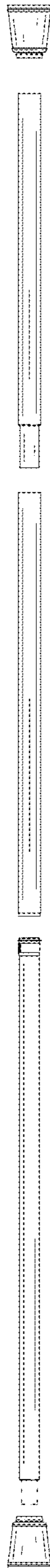

FIG. 16

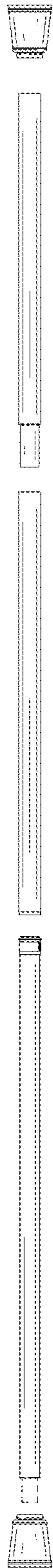

FIG. 17



FIG. 18

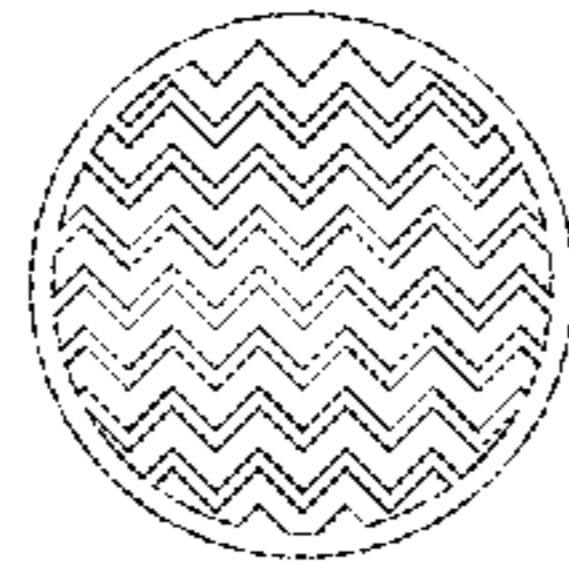

FIG. 19

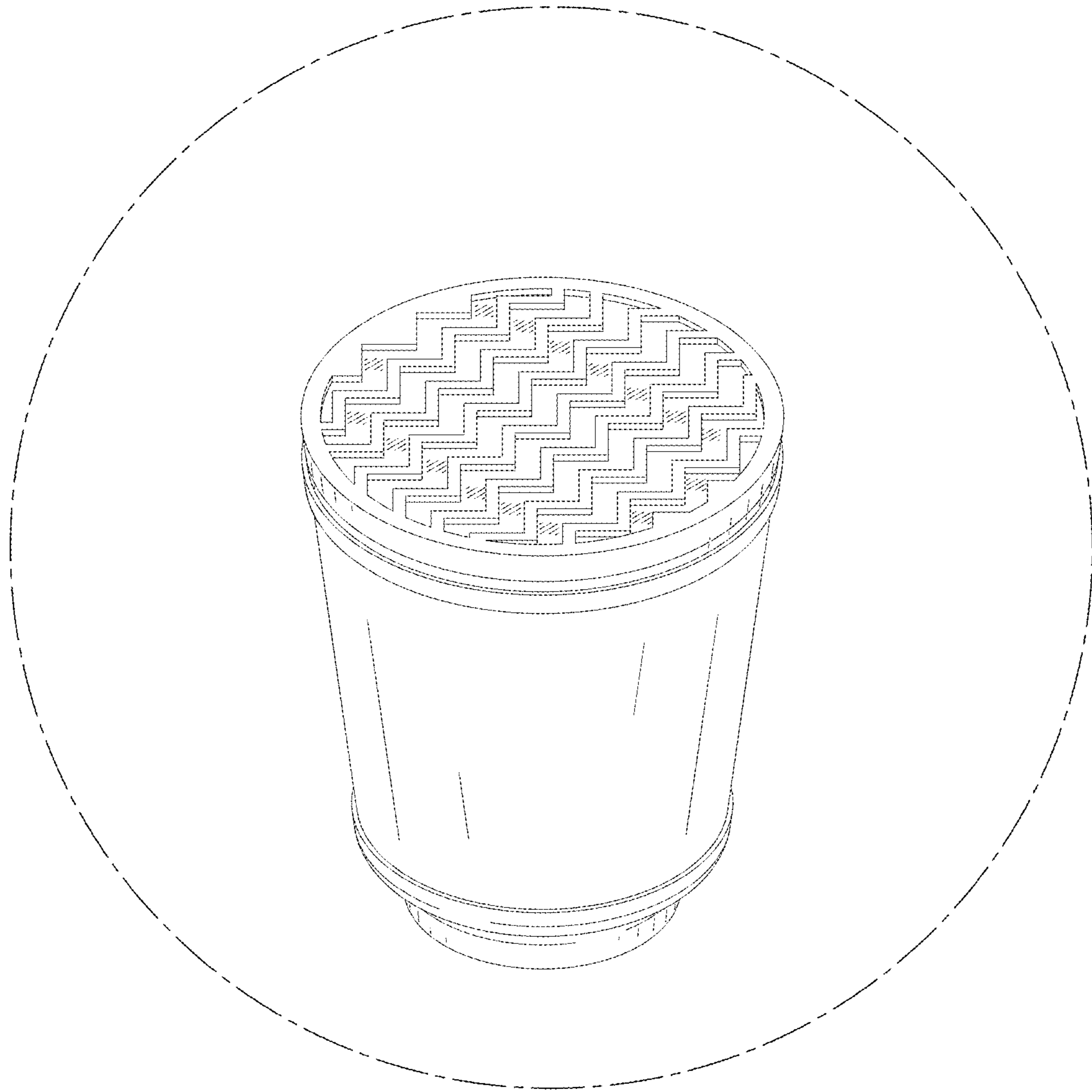

FIG. 20

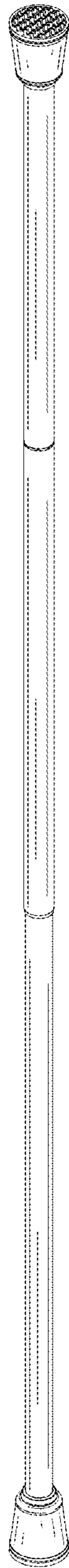

FIG. 21