



US00D986179S

(12) **United States Design Patent**
Chen

(10) **Patent No.:** **US D986,179 S**

(45) **Date of Patent:** **** May 16, 2023**

(54) **SMART WALL OUTLET**

(71) Applicant: **Cai Chen**, Guangdong (CN)

(72) Inventor: **Cai Chen**, Guangdong (CN)

(73) Assignee: **Shenzhen Cuco Smart Technology Co., Ltd**, Guangdong (CN)

(**) Term: **15 Years**

(21) Appl. No.: **29/716,042**

(22) Filed: **Dec. 6, 2019**

(51) **LOC (14) Cl.** **13-03**

(52) **U.S. Cl.**
USPC **D13/137.2**

(58) **Field of Classification Search**
USPC ... D13/110, 133, 137.1, 137.2, 137.3, 137.4, D13/138.1, 138.2, 139.1, 139.2, 139.3, D13/139.4, 139.5, 139.6, 139.7, 139.8, D13/152, 199; D14/433; D8/350, 353
CPC H01R 35/04; H01R 2103/00; H01R 31/06; H01R 31/005; H01R 2201/06; H01R 13/665; H01R 13/7135; H01R 13/652; H01R 13/506; H01R 13/514; H01R 13/518; H01R 13/6272; H01R 13/46; G06F 13/4022; G06F 13/382; G06F 1/1632; G06F 1/1684; G06F 1/20; G06F 1/1607; H02J 7/0062; H02J 2007/0062; H02J 7/00043; H02J 7/0021; H02J 7/0026; H02J 7/0027; H02J 7/0045; H02H 13/16; H02G 3/088

See application file for complete search history.

(56) **References Cited**

U.S. PATENT DOCUMENTS

D455,331 S * 4/2002 Keenum D8/353
D535,254 S * 1/2007 Bazayev D13/139.3
D535,255 S * 1/2007 Bazayev D13/139.3
D542,223 S * 5/2007 Bazayev D13/139.3
D558,676 S * 1/2008 Fort D13/139.3
D595,229 S * 6/2009 LaGrotta D13/137.2

D638,688 S * 5/2011 Sheremeta D8/353
D711,828 S * 8/2014 Mozdzer D13/139.1
D770,976 S * 11/2016 Xu D13/110
D814,420 S * 4/2018 Chen D13/137.2
D817,281 S * 5/2018 Salas D13/137.2

(Continued)

FOREIGN PATENT DOCUMENTS

CA 152712 * 8/2014
CA 167925 * 1/2017

OTHER PUBLICATIONS

“(2 Pack, Glossy Gray) ELEGRP USB Outlet Wall Charger, Dual High Speed 4.0 Amp USB Ports with Smart Chip, 15 Amp Duplex Tamper Resistant Receptacle Plug NEMA 5-15R, Wall Plate Included, UL Listed”, first available Aug. 14, 2019. Amazon.com [https://www.amazon.com/ELEGRP-Charger-Resistant-Receptacle-Included/dp/B07WMNYNH2/ref=sr_1_25?dchild=1&keywords=electrical+receptacle%E2%80%A6] (Year: 2019).*

(Continued)

Primary Examiner — Michael A. Pratt

(57) **CLAIM**

I claim the ornamental design for a smart wall outlet, as shown and described.

DESCRIPTION

FIG. 1 is a perspective view of a smart wall outlet showing my new design;
FIG. 2 is a front elevational view thereof;
FIG. 3 is a rear elevational view thereof;
FIG. 4 is a left side elevational view thereof;
FIG. 5 is a right side elevational view thereof;
FIG. 6 is a top plan view thereof;
FIG. 7 is a bottom plan view thereof; and,
FIG. 8 rear and left side perspective view thereof.
The broken lines shown in the drawings are for purpose of illustrating portions of the smart wall outlet that form no part of the claimed design.

1 Claim, 8 Drawing Sheets

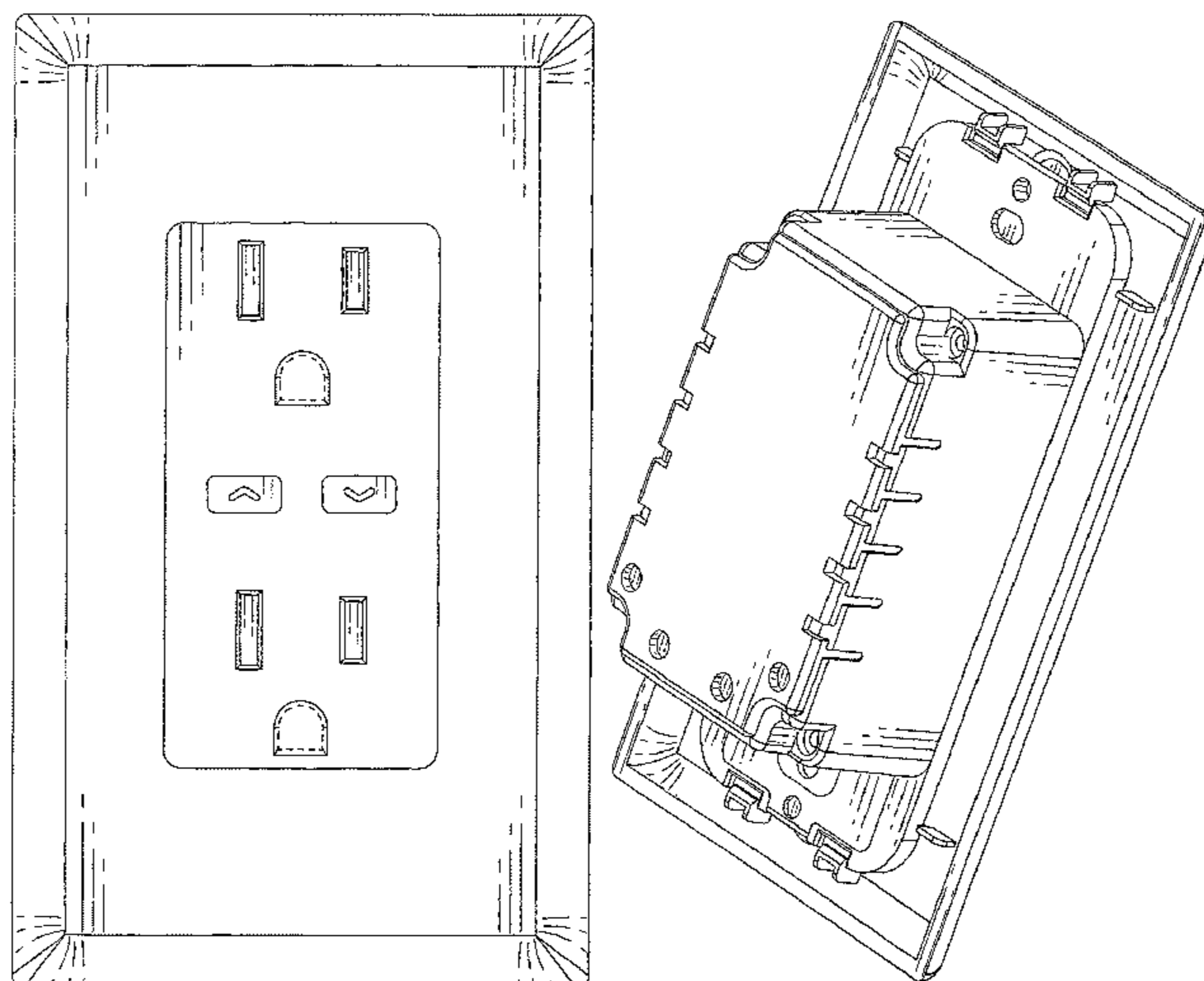

(56)

References Cited

U.S. PATENT DOCUMENTS

D819,426	S	*	6/2018	Smith	D8/353
D820,211	S	*	6/2018	Salas	D13/137.2
D820,212	S	*	6/2018	Stern	D13/137.2
D852,140	S	*	6/2019	Chen	D13/137.2
D853,333	S	*	7/2019	Salas	D13/139.3
D870,671	S	*	12/2019	Salas	D13/139.3
D872,695	S	*	1/2020	Bo	D13/137.2
D873,775	S	*	1/2020	Salas	D13/139.3
2011/0209891	A1	*	9/2011	Huang	H02G 3/14 174/66

OTHER PUBLICATIONS

“20 Pack—Electeck 15 Amp Decorator Outlet with Wall Plate, Non-Tamper Resistant and Residential Receptacle, UL Listed, White”,

first available Nov. 1, 2019. Amazon.com [https://www.amazon.com/Pack-Decorator-Non-Tamper-Residential-Receptacle/dp/B07ZRGKWV9/ref=sr_1_6?dchild=1&keywords=electrical+receptac%E2%80%A6] (Year: 2019).*

“Coby USB Wall Outlet Dual High Speed 6.0 Amp USB Ports with Smart Chip, USB Type C Port, 15A Duplex Tamper Resistant Receptacle Electrical Outlet, Pack of 2”, first available Oct. 27, 2020. Amazon.com [https://www.amazon.com/Coby-Charger-Resistant-Receptacle-Electrical/dp/B08MTDDFBX/ref=sr_1_24?dchild=1&keywords=electrical%2Breceptacle&q%E2%80%A6=undefined&th=1] (Year: 2020).*

“Faith 20A GFCI Outlet, Non-Tamper-Resistant GFI Duplex Receptacles with LED Indicator, Self-Test Ground Fault Circuit Interrupter with Wall Plate, ETL Listed, White”, first available Jun. 3, 2019. Amazon.com [https://www.amazon.com/Faith-Electric-GFCI-Outlet-Non-Tamper-Resistant/dp/B07SM3ZD9J/ref=sr_1_11?dchild=1&keywords=electrical+receptacle%E2%80%A6] (Year: 2019).*

* cited by examiner

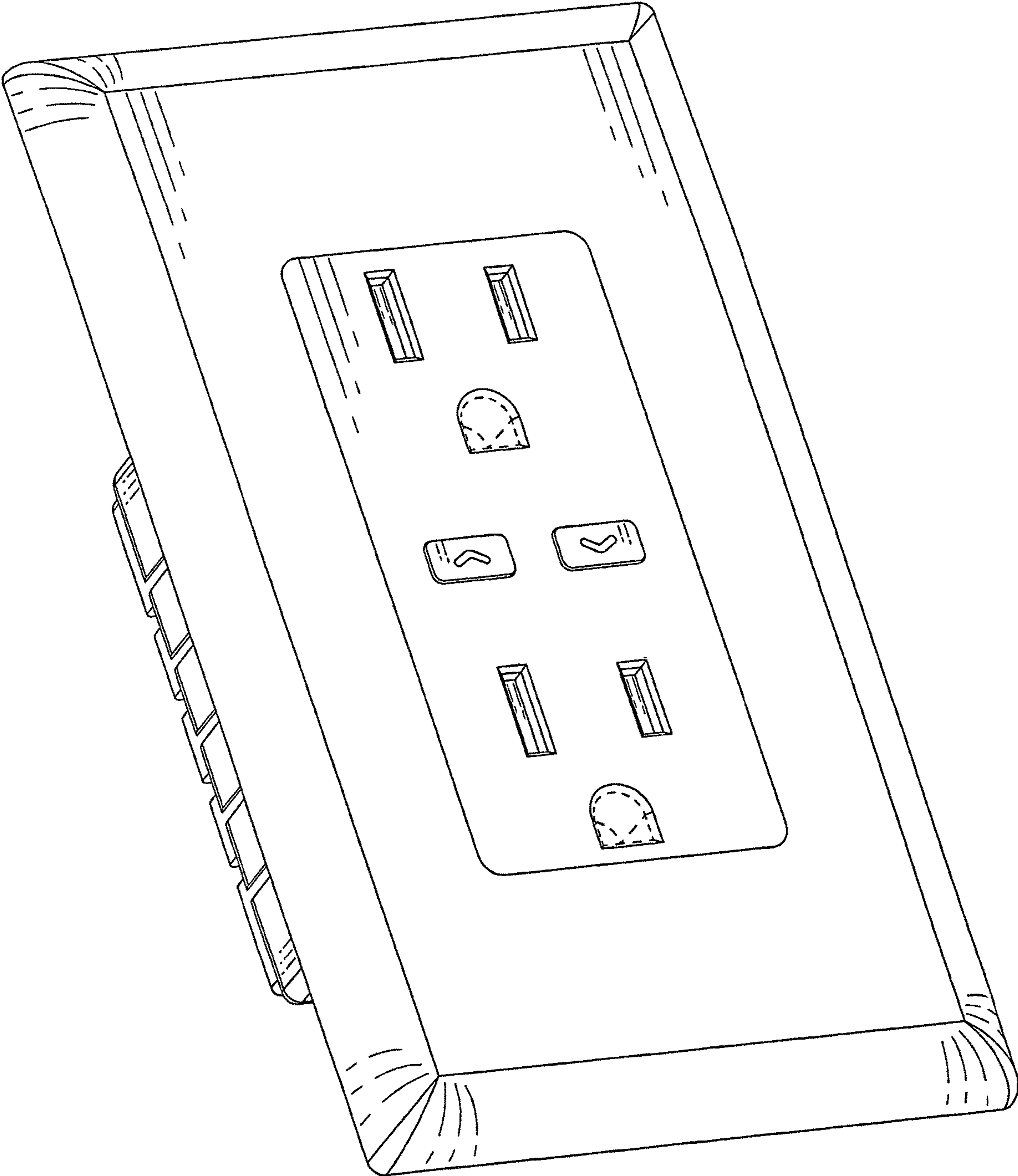

FIG. 1

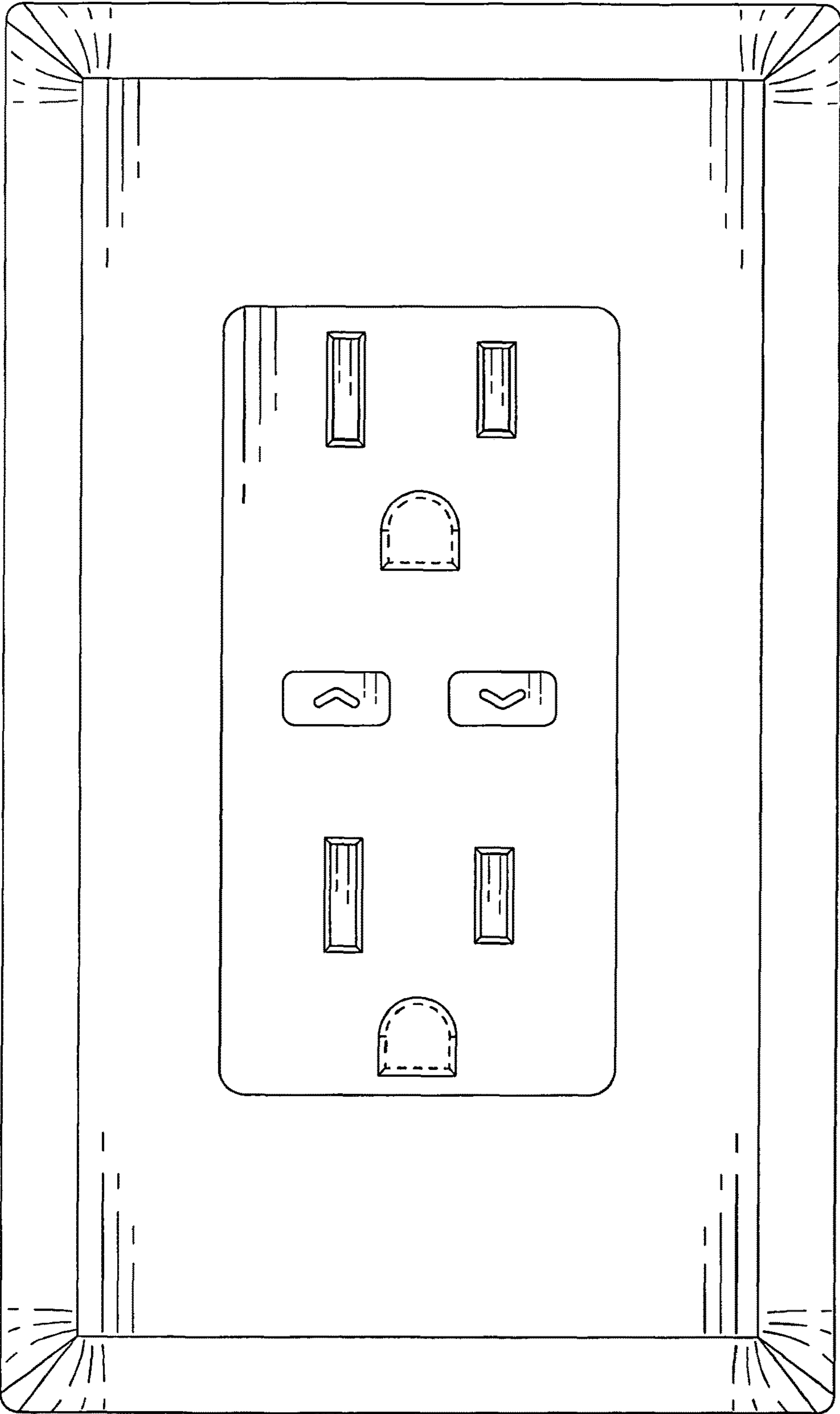

FIG. 2

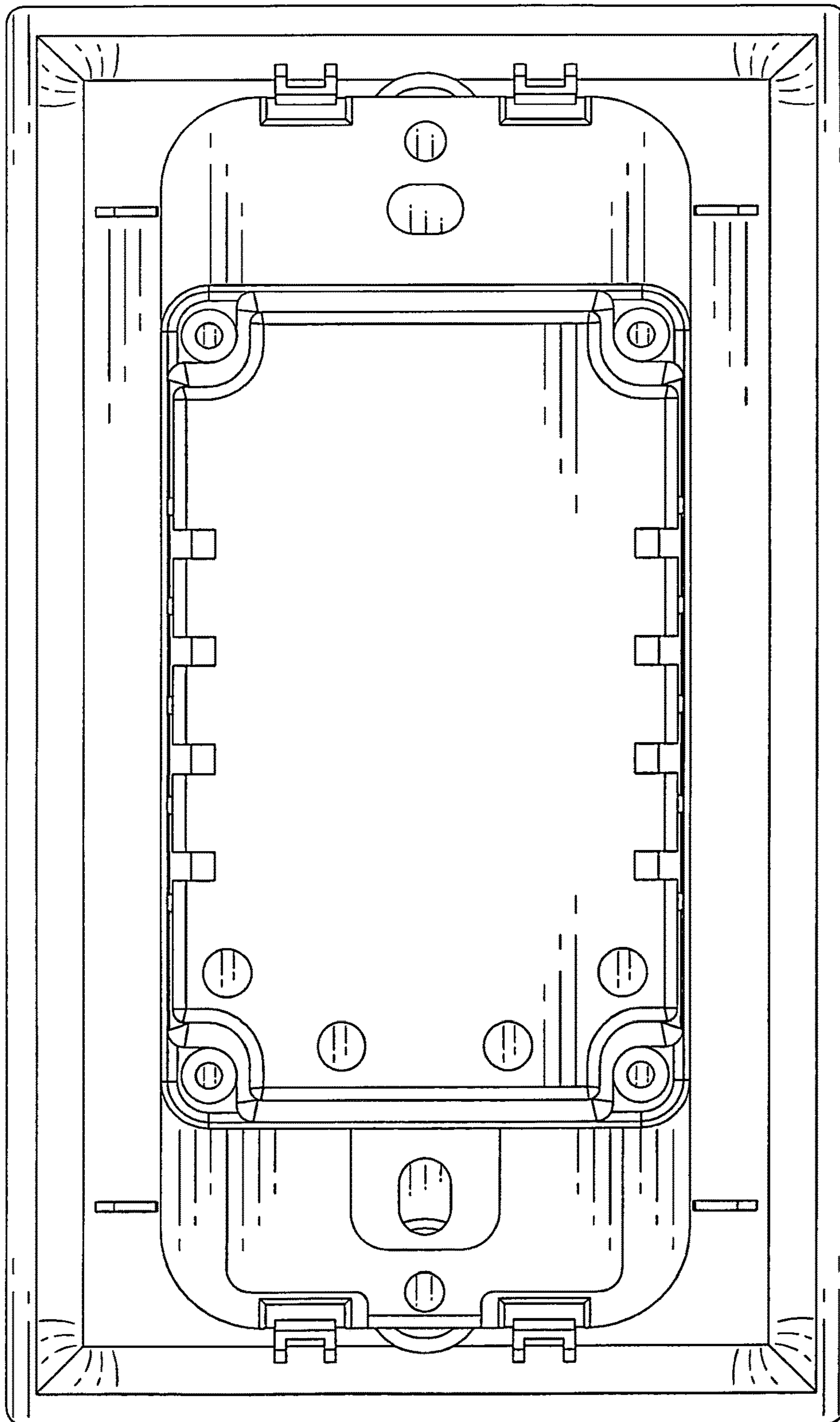

FIG. 3

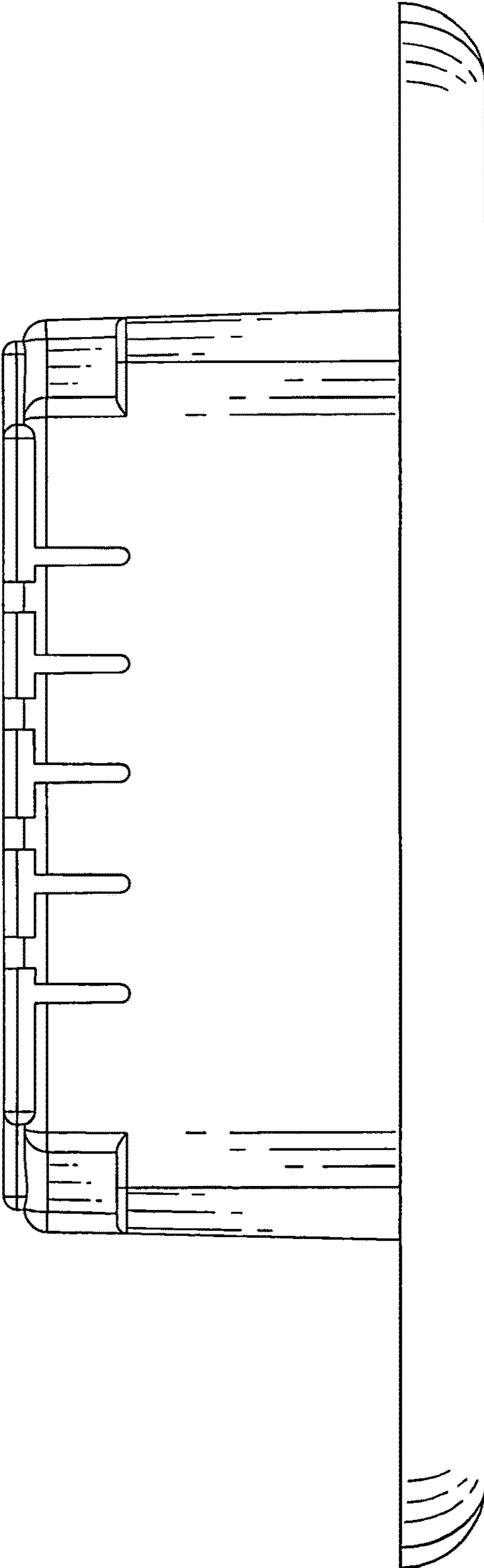

FIG. 4

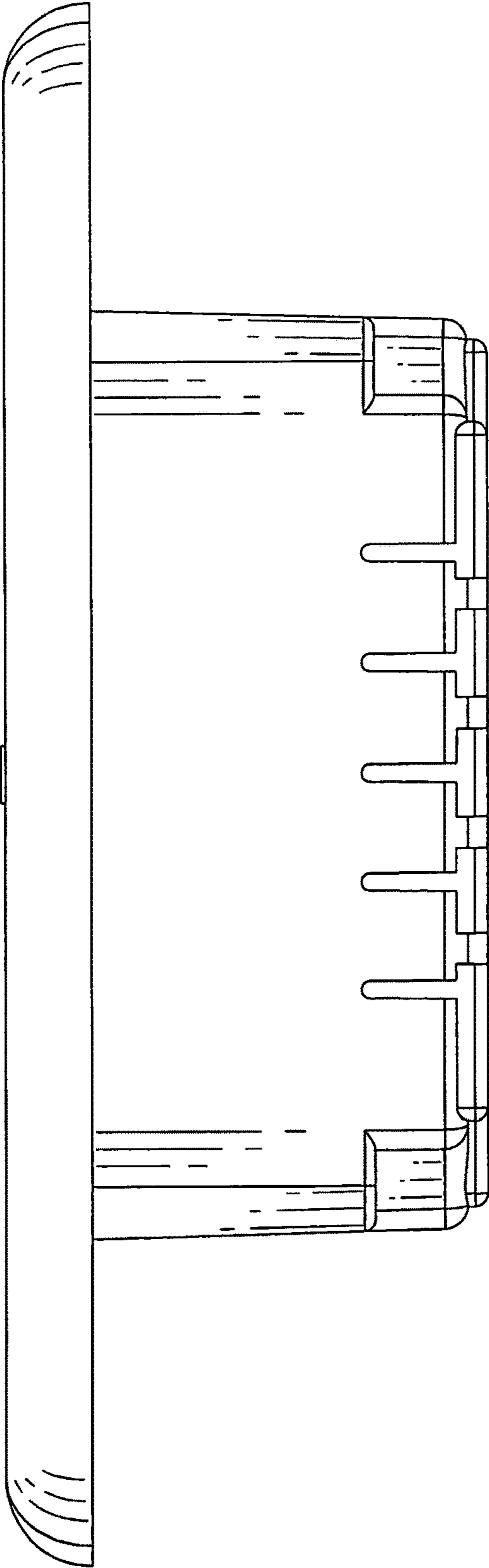

FIG. 5

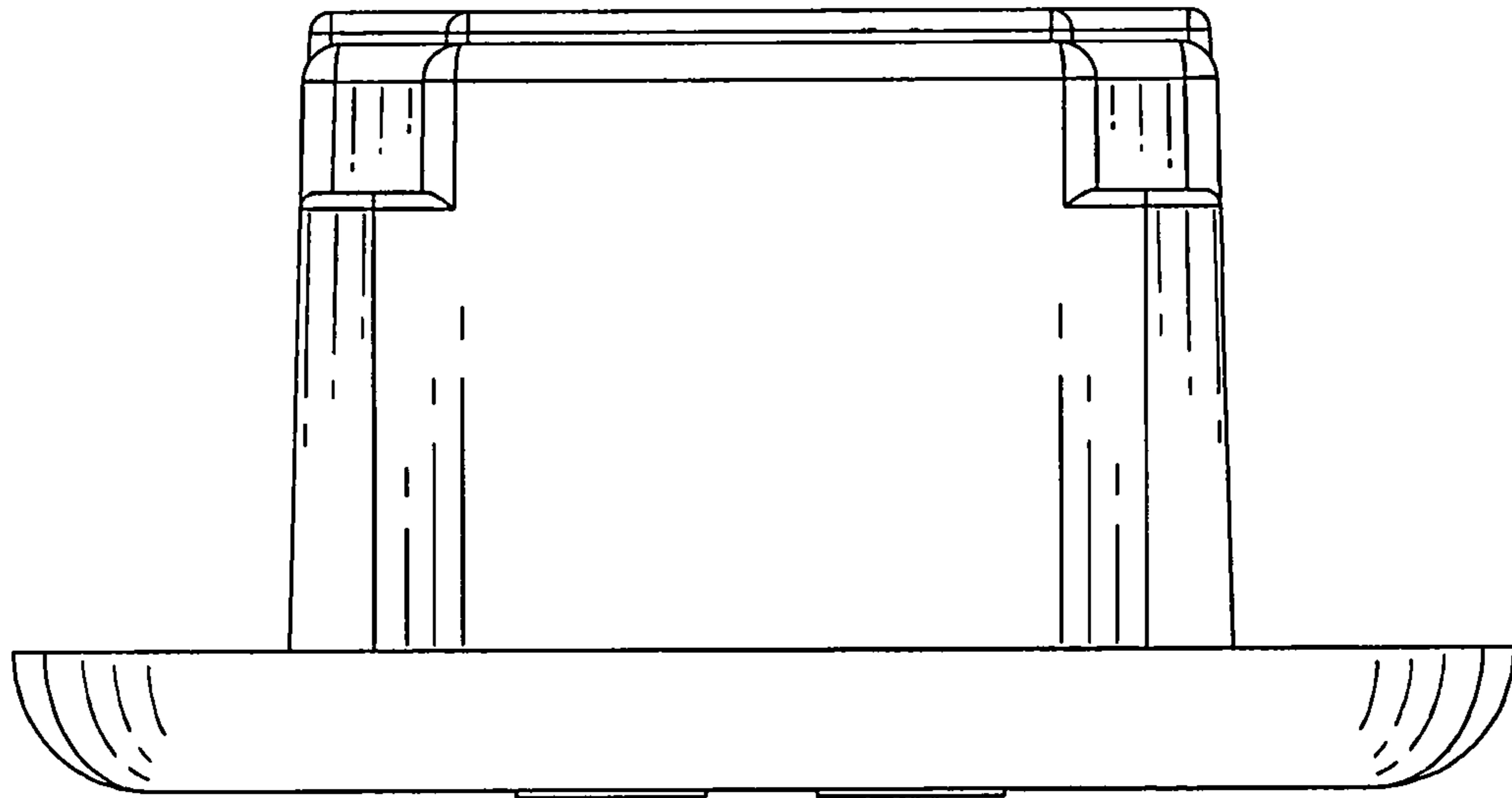

FIG. 6

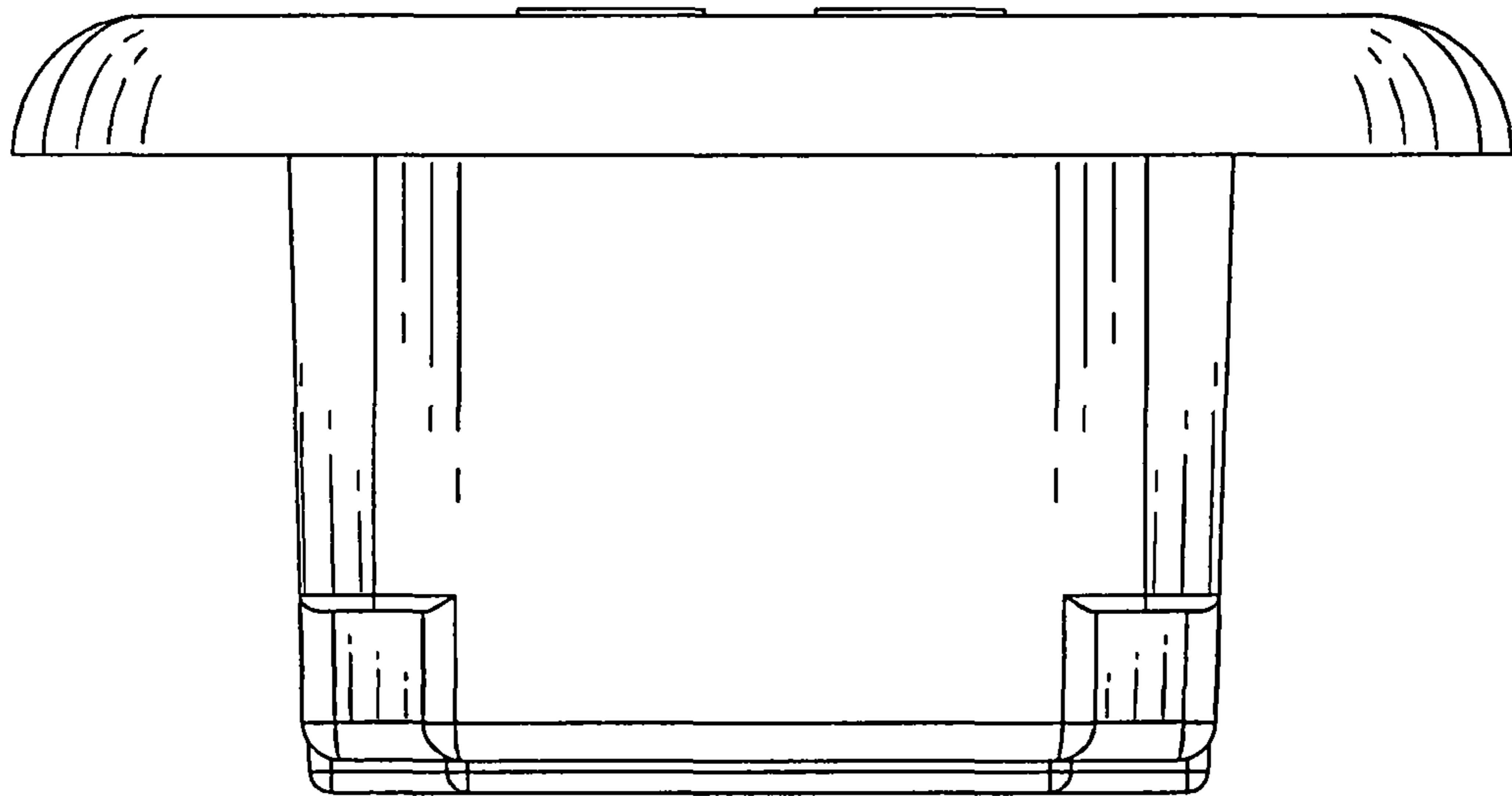

FIG. 7

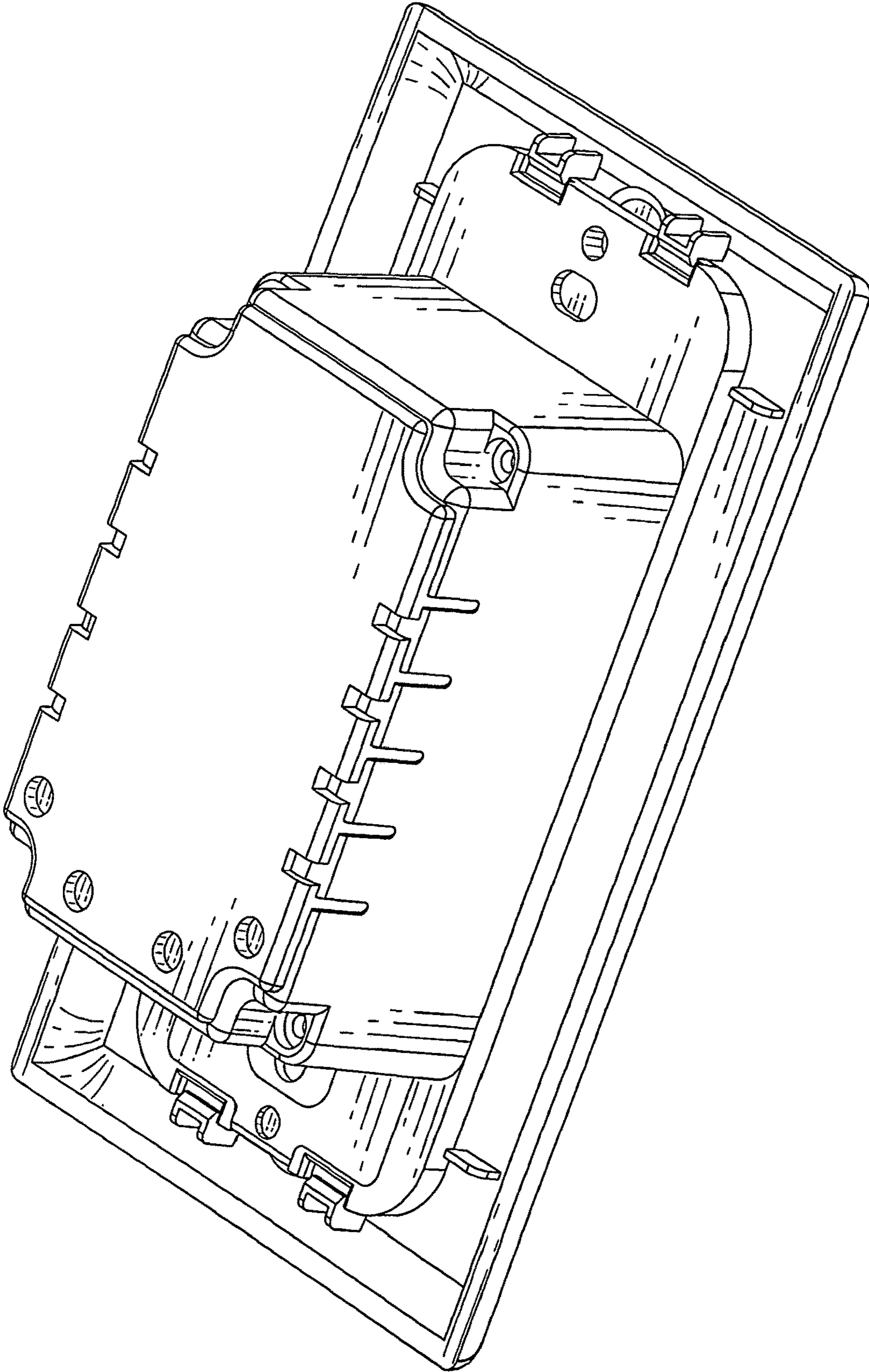

FIG. 8