



US00D986135S

(12) **United States Design Patent** (10) **Patent No.:** **US D986,135 S**
Berche et al. (45) **Date of Patent:** **** May 16, 2023**

(54) **PERSONAL WATERCRAFT LATERAL FASCIA**
(71) Applicant: **BOMBARDIER RECREATIONAL PRODUCTS INC., Valcourt (CA)**
(72) Inventors: **Charles-Edouard Berche, Bromont (CA); Francois Chenevert, Sherbrooke (CA)**
(73) Assignee: **BOMBARDIER RECREATIONAL PRODUCTS INC., Valcourt (CA)**
(**) Term: **15 Years**
(21) Appl. No.: **29/807,176**
(22) Filed: **Sep. 9, 2021**
(51) **LOC (14) Cl.** **12-11**
(52) **U.S. Cl.**
USPC **D12/317**
(58) **Field of Classification Search**
USPC D12/6-10, 110, 114, 117, 126, 182, 186, D12/300, 307, 317; D21/432
CPC B63B 34/00; B63B 34/10; B63H 11/00; B62J 17/00; B62J 17/02; B62J 17/04
See application file for complete search history.

(56) **References Cited**
U.S. PATENT DOCUMENTS
D711,290 S * 8/2014 Akita D12/126
D803,105 S * 11/2017 Tsuji D12/114
D851,568 S * 6/2019 Tsuji D12/114
D885,989 S * 6/2020 Shigihara D12/114
D885,990 S * 6/2020 Katagiri D12/114

FOREIGN PATENT DOCUMENTS
LA 77-0001 * 5/2009
* cited by examiner
Primary Examiner — Joseph Kukella
Assistant Examiner — Lavon M. Amerson
(74) *Attorney, Agent, or Firm* — BCF LLP
(57) **CLAIM**
The ornamental design for a personal watercraft lateral fascia, as shown and described.

DESCRIPTION
FIG. 1 is a perspective view taken from a front, left, top side of a personal watercraft lateral fascia according to a first embodiment of our design;
FIG. 2 is a front view thereof;
FIG. 3 is a rear view thereof;
FIG. 4 is a right side view thereof;
FIG. 5 is a left side view thereof;
FIG. 6 is a top view thereof;
FIG. 7 is a bottom view thereof;
FIG. 8 is a perspective view taken from a front, right, top side of a personal watercraft lateral fascia according to a second embodiment of our design;
FIG. 9 is a front view thereof;
FIG. 10 is a rear view thereof;
FIG. 11 is a left side view thereof;
FIG. 12 is a right side view thereof;
FIG. 13 is a top view thereof; and,
FIG. 14 is a bottom view thereof.
Throughout the Figures, where shown, the dashed lines are included for the purpose of illustrating portions of the article which form no part of the claimed design.

1 Claim, 14 Drawing Sheets

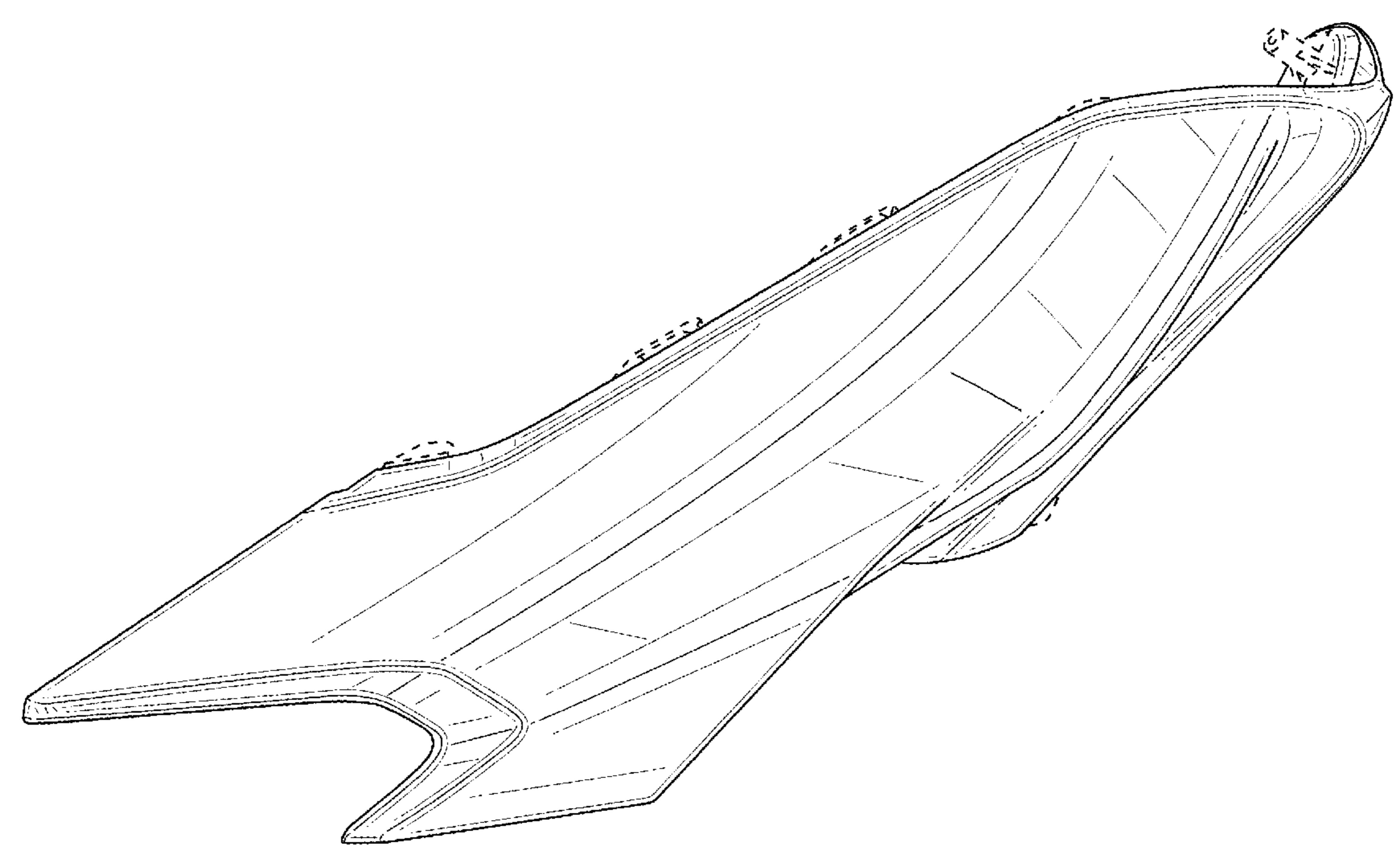

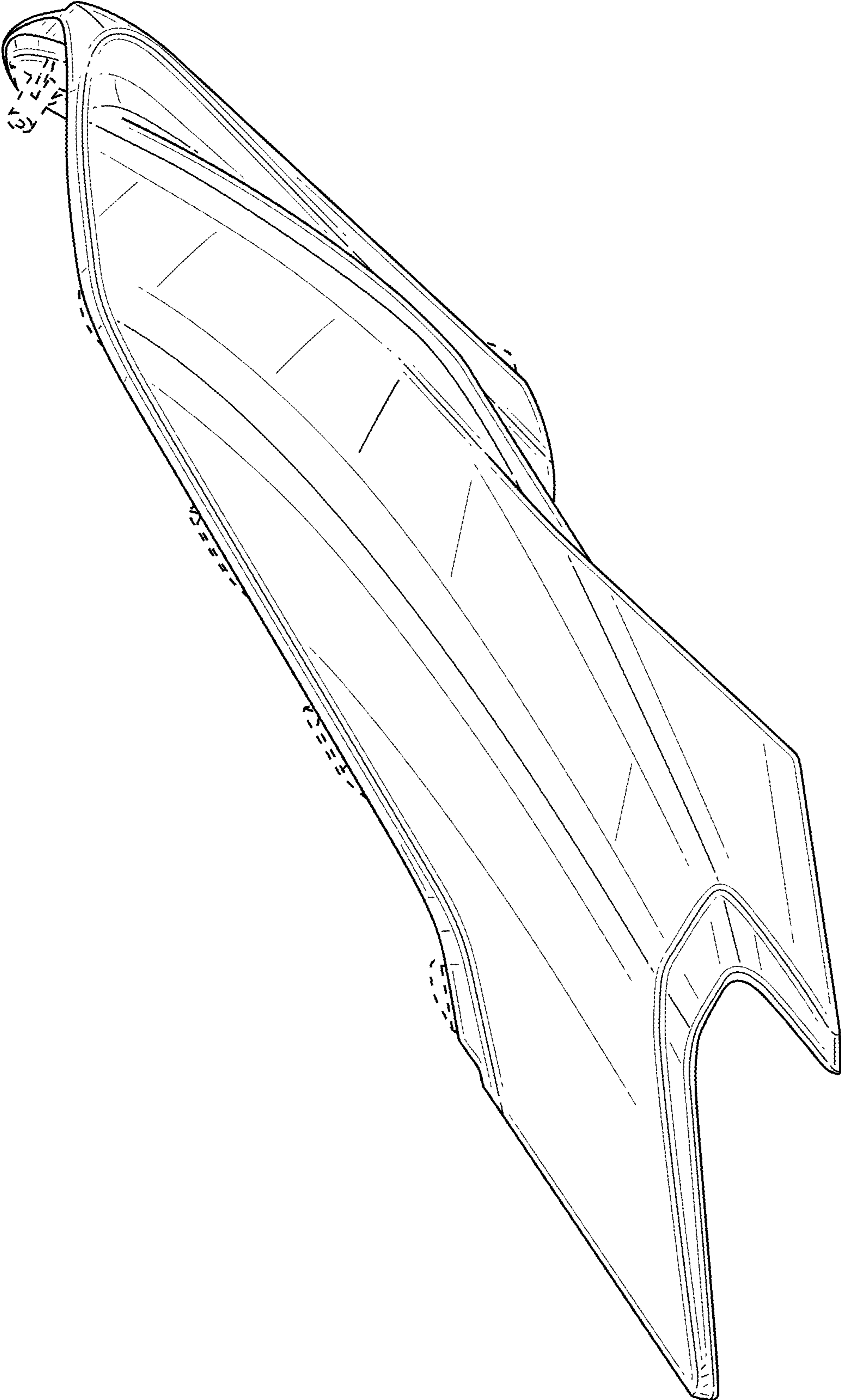

FIG. 1

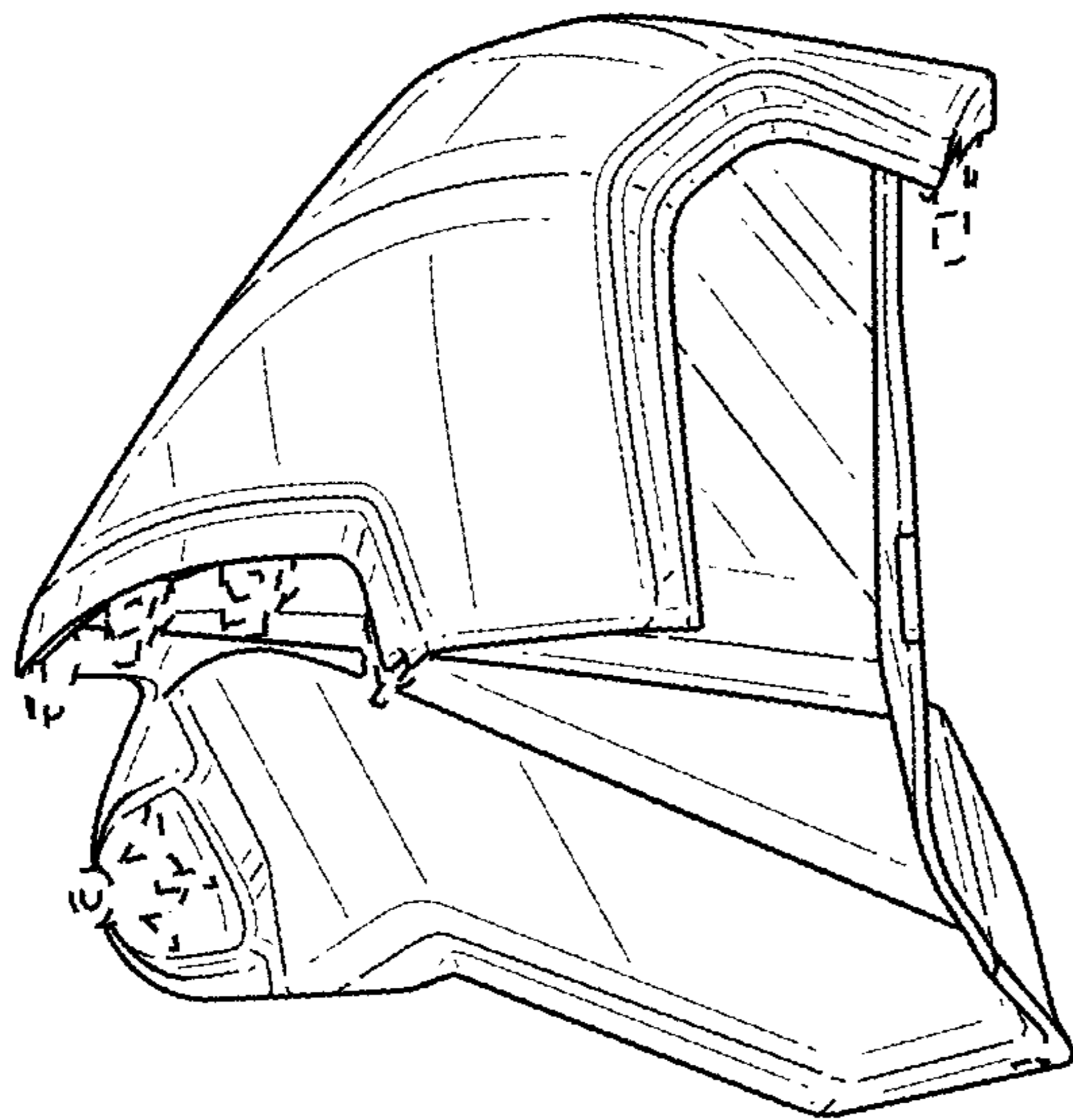

FIG. 2

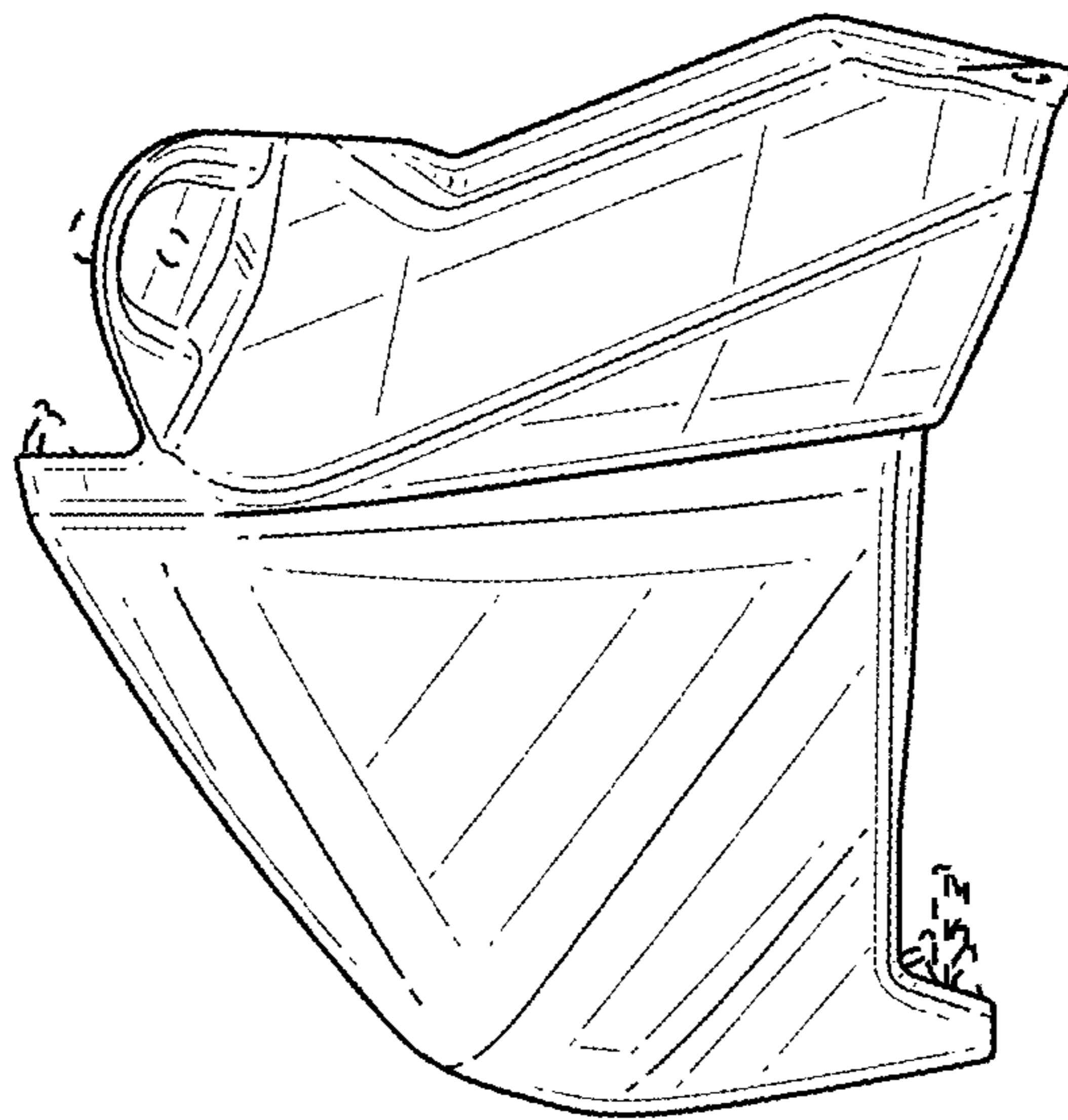

FIG. 3

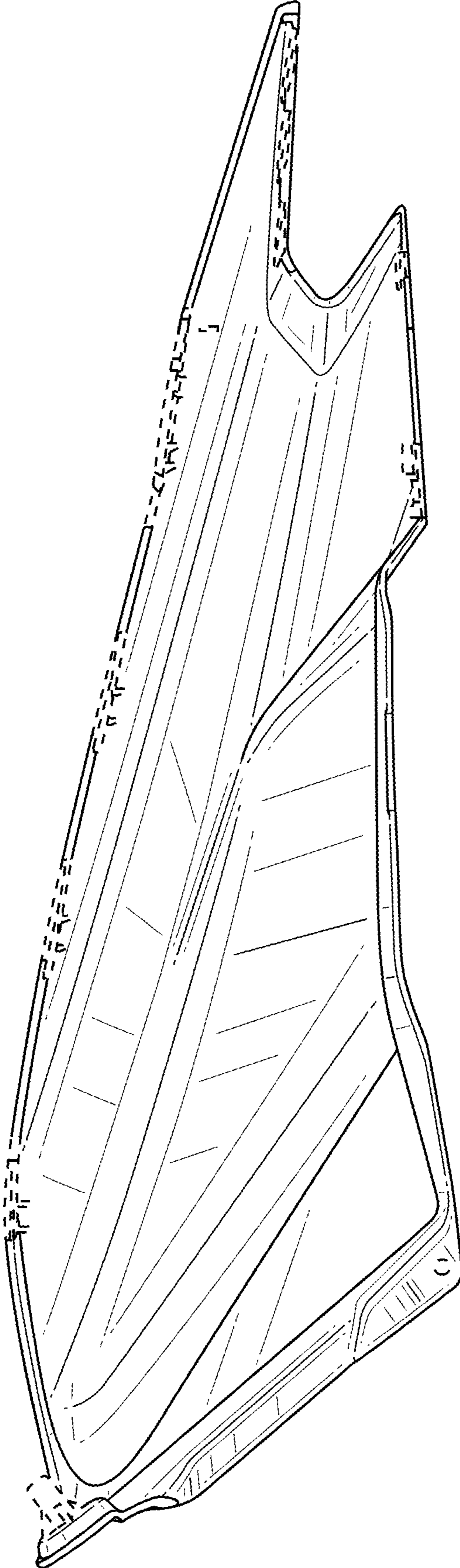

FIG. 4

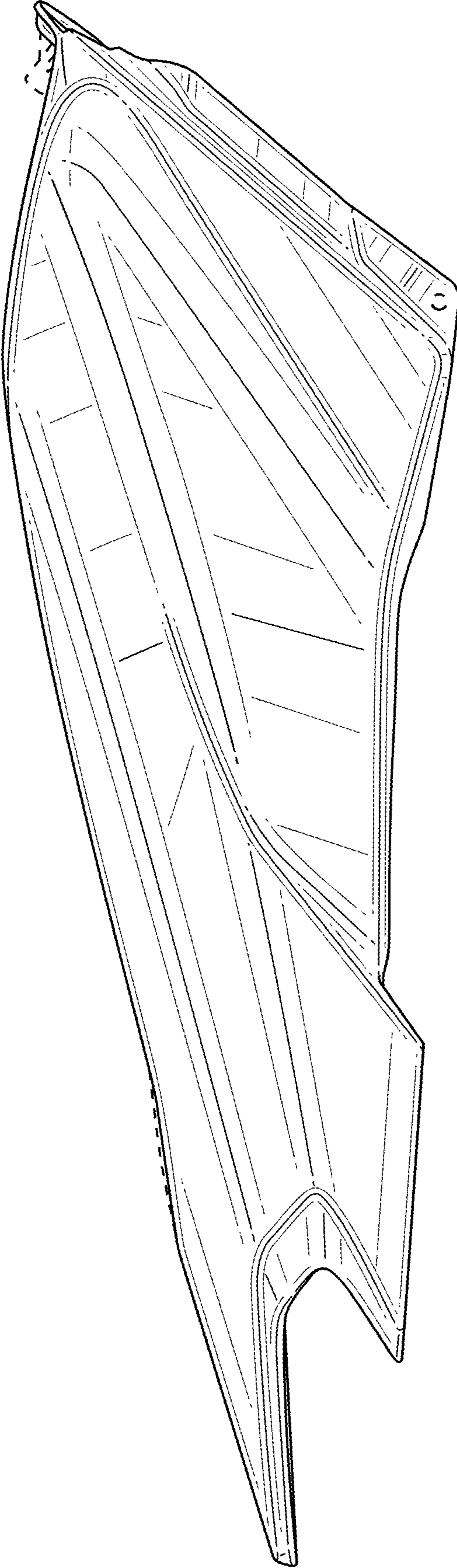

FIG. 5

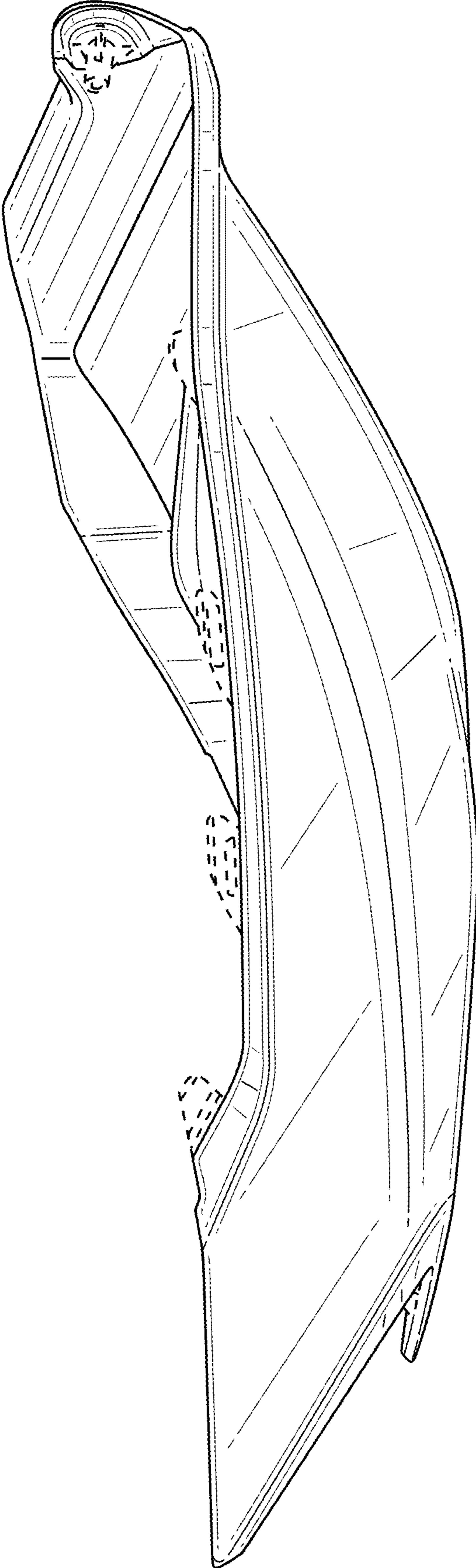

FIG. 6

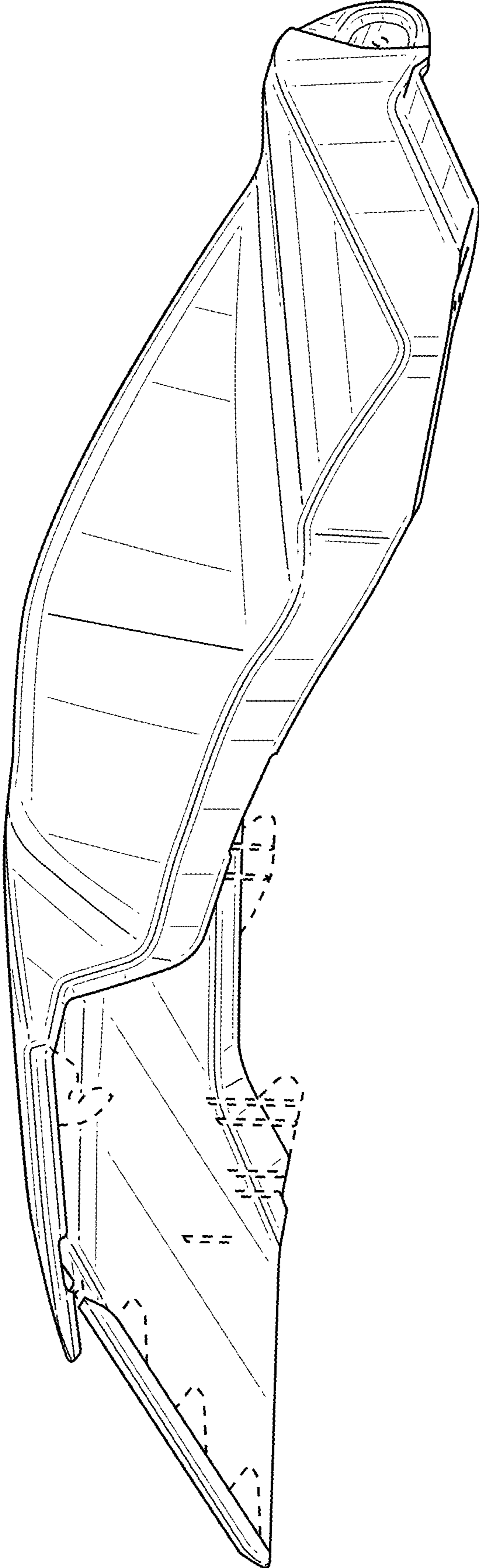

FIG. 7

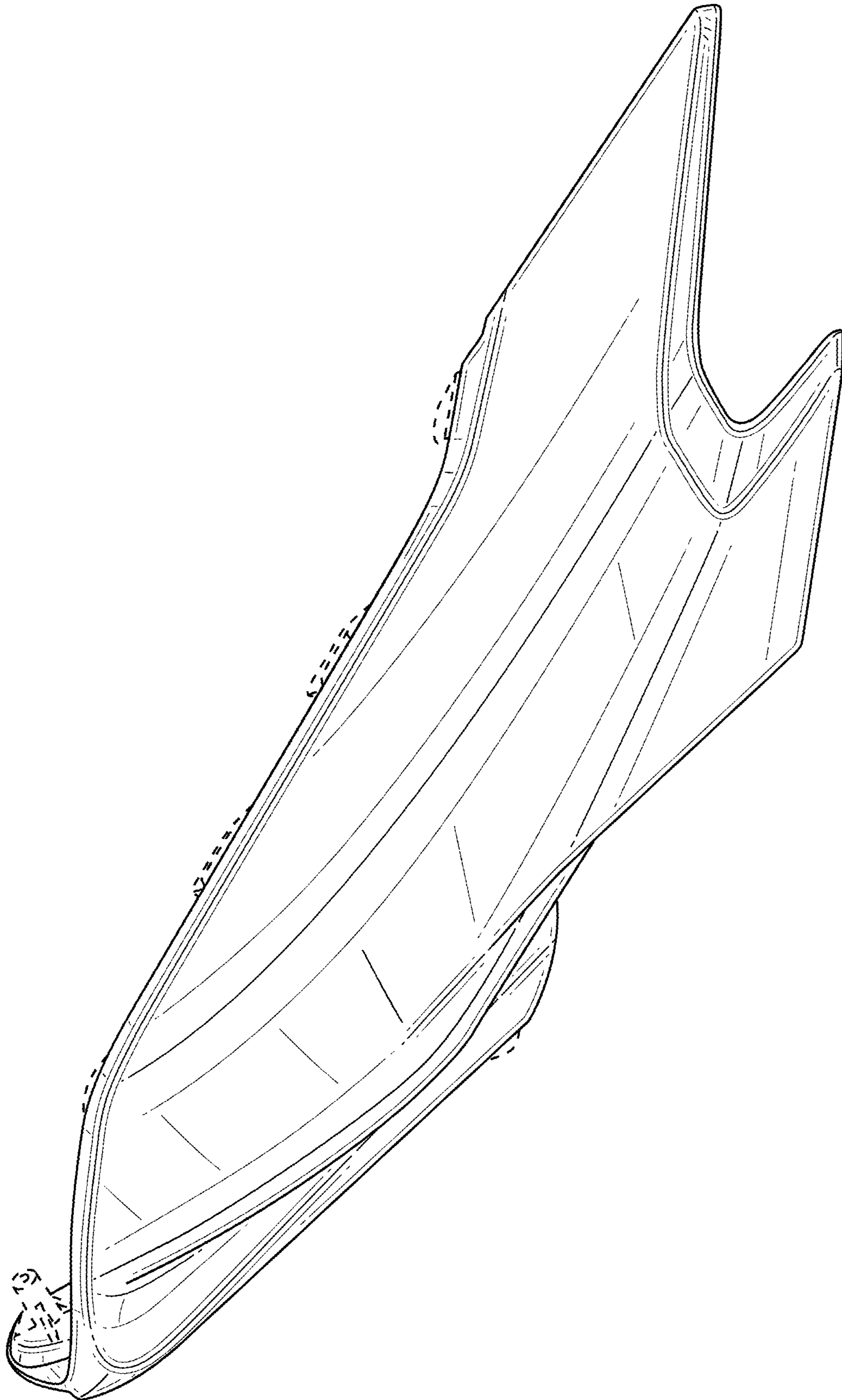

FIG. 8

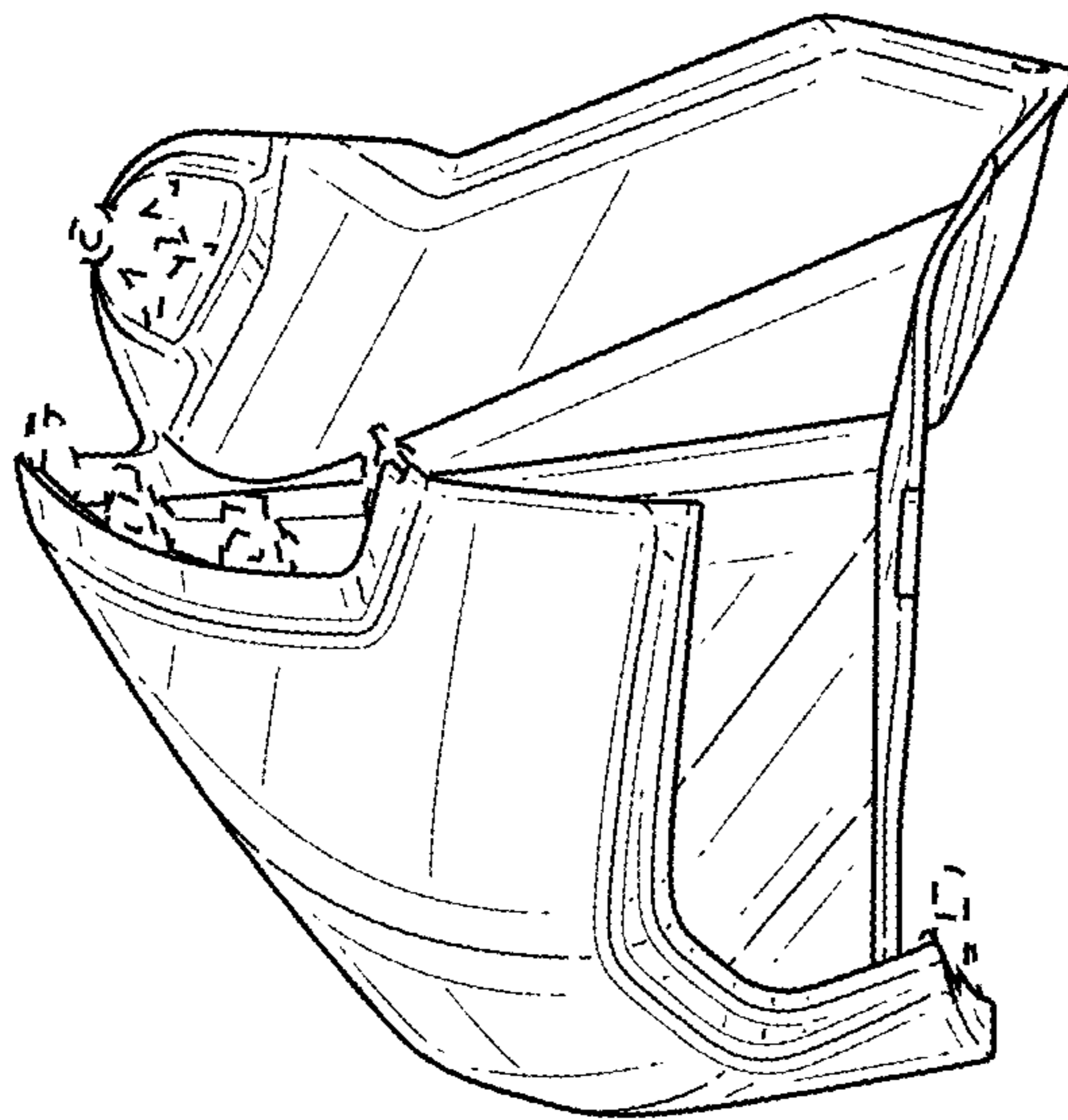

FIG. 9

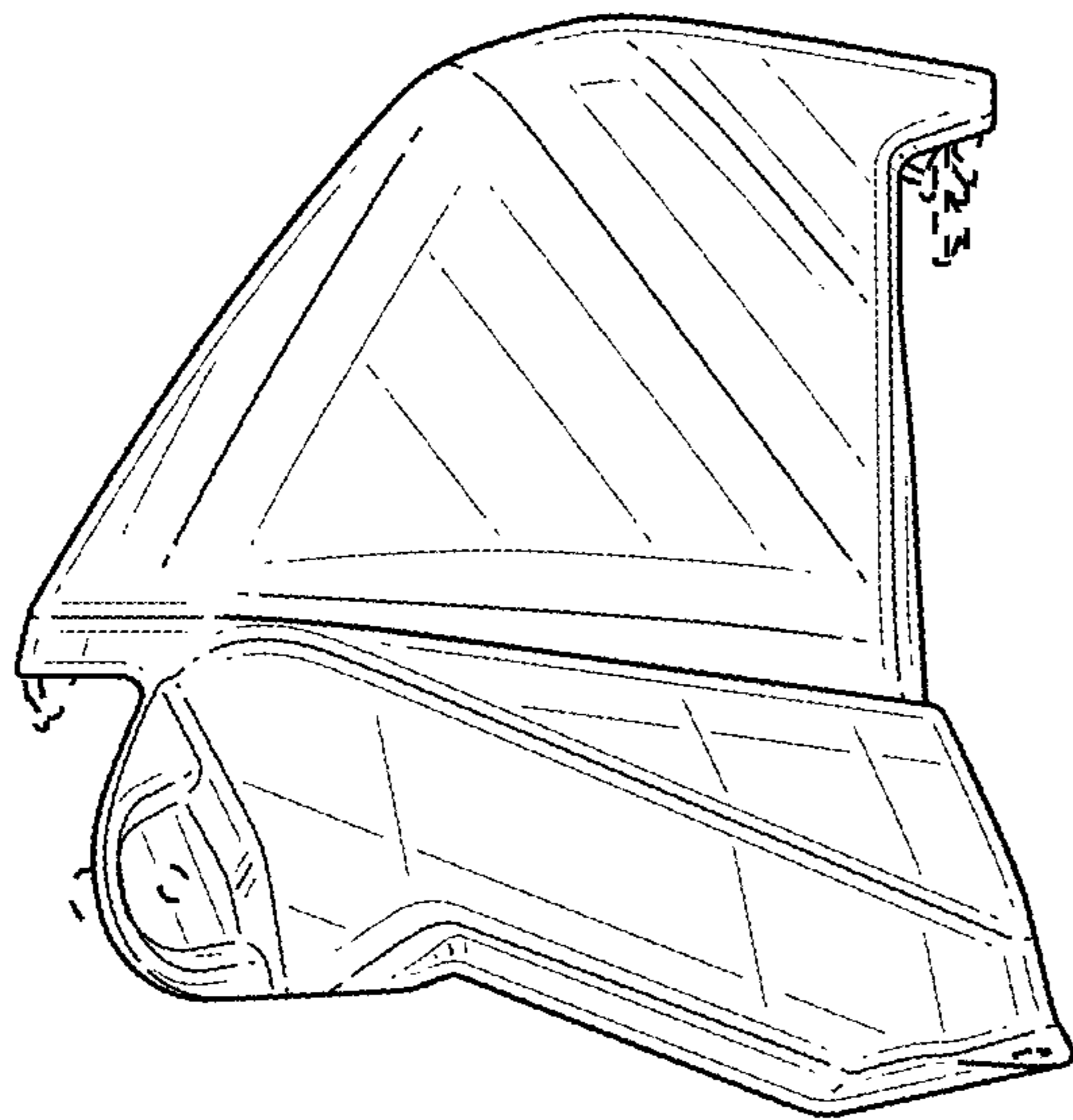

FIG. 10

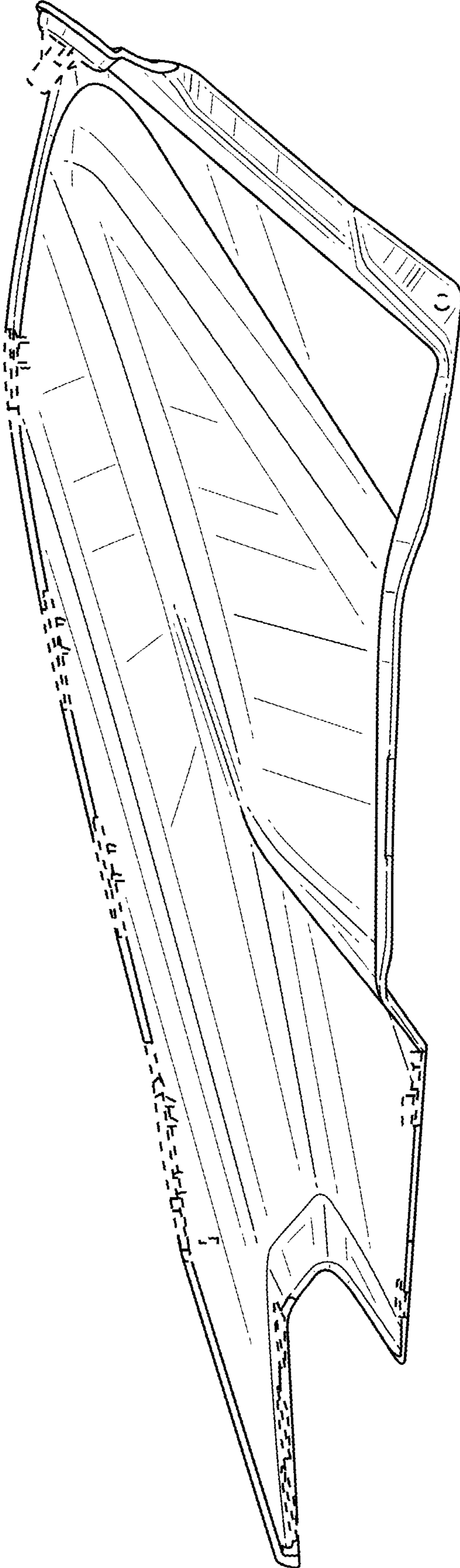

FIG. 11

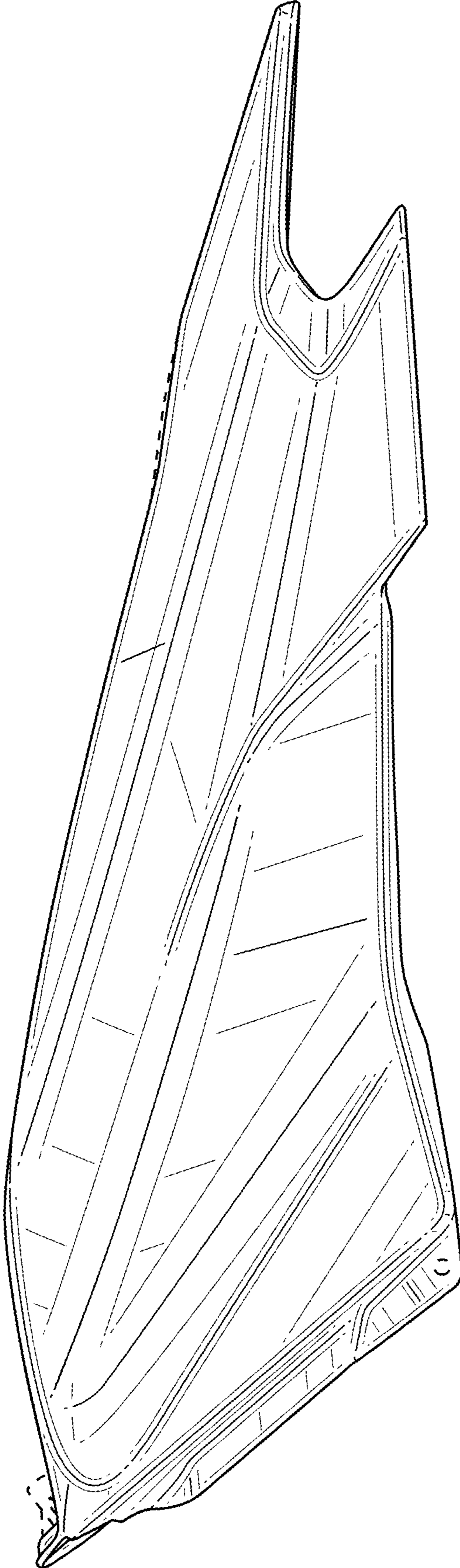

FIG. 12

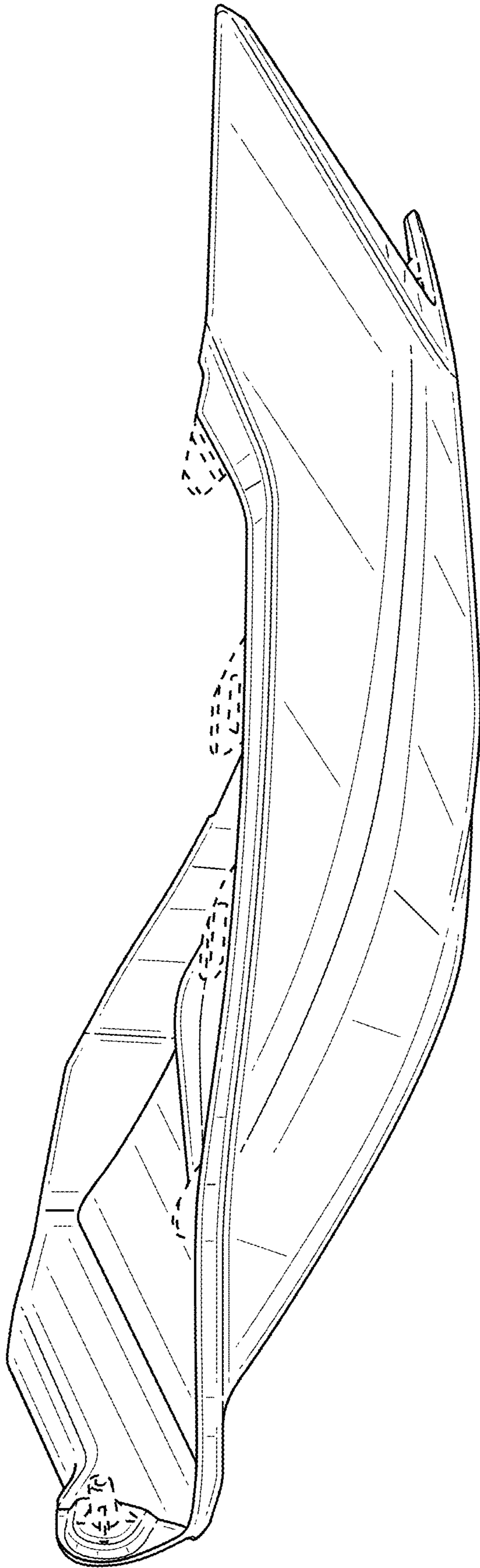

FIG. 13

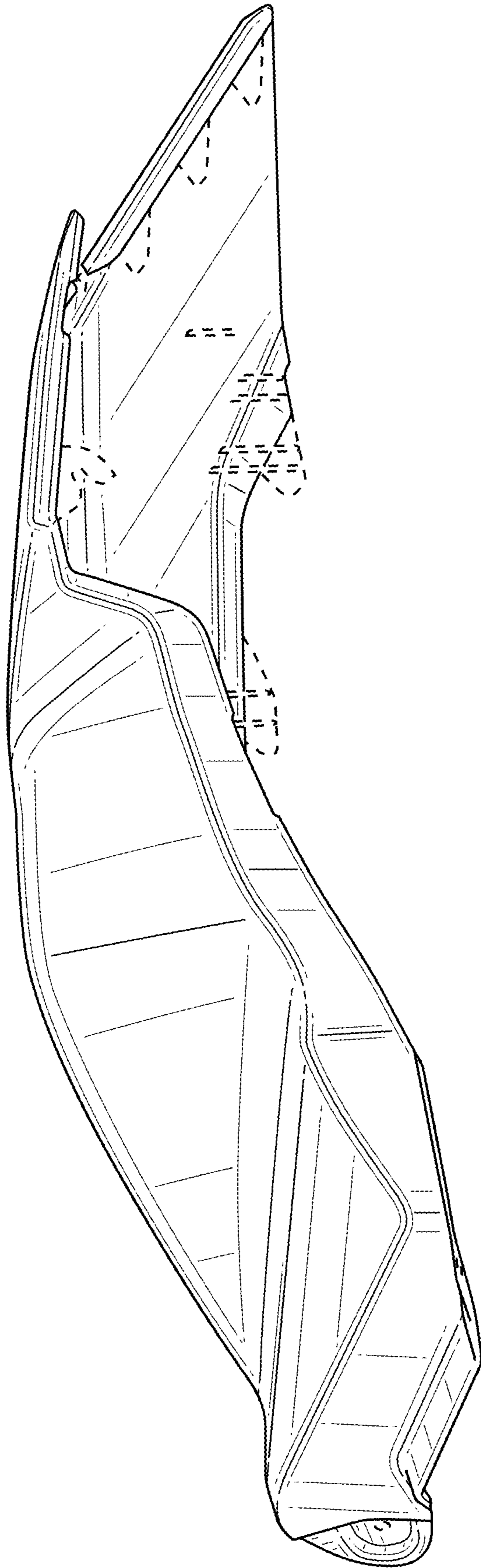

FIG. 14