



US00D986089S

(12) **United States Design Patent** (10) **Patent No.:** **US D986,089 S**
Guo (45) **Date of Patent:** **** May 16, 2023**

(54) **WATCH BAND**

<https://www.amazon.com/Nereides-Compatible-Apple-Sports-Design/dp/BOBFZTXGMN> (Year: 2022).*

(71) Applicant: **Shenzhen Jiyou Supply Chain Co. LTD.**, Guangdong (CN)

(Continued)

(72) Inventor: **Yujin Guo**, Guangdong (CN)

Primary Examiner — W. A. Teddy Falloway

Assistant Examiner — Sarah J Ault

(73) Assignee: **Shenzhen Jiyou Supply Chain Co. LTD.**, Guangdong (CN)

(74) *Attorney, Agent, or Firm* — ScienBiziP, P.C.

(**) Term: **15 Years**

(57) **CLAIM**

The ornamental design for a watch band, as shown and described.

(21) Appl. No.: **29/860,806**

DESCRIPTION

(22) Filed: **Nov. 22, 2022**

(30) **Foreign Application Priority Data**

Nov. 15, 2022 (EM) 15003234-0001
Nov. 15, 2022 (EM) 15003234-0002
Nov. 15, 2022 (EM) 15003234-0003

FIG. 1 is a front, right and top perspective view of a watch band, showing my design.

FIG. 2 is a rear, left and bottom perspective view thereof.

FIG. 3 is a front elevation view thereof.

FIG. 4 is a rear elevation view thereof.

FIG. 5 is a left side elevation view thereof.

FIG. 6 is a right side elevation view thereof.

FIG. 7 is a top plan view thereof.

FIG. 8 is a bottom plan view thereof.

FIG. 9 is a front, right and top perspective view of a second embodiment of a watch band.

FIG. 10 is a rear, left and bottom perspective view of the second embodiment of the watch band of FIG.9.

FIG. 11 is a front elevation view of the second embodiment of the watch band of FIG. 9.

FIG. 12 is a rear elevation view of the second embodiment of the watch band of FIG. 9.

FIG. 13 is a left side elevation view of the second embodiment of the watch band of FIG. 9.

FIG. 14 is a right side elevation view of the second embodiment of the watch band of FIG. 9.

FIG. 15 is a top plan elevation view of the second embodiment of the watch band of FIG. 9.

FIG. 16 is a bottom plan elevation view of the second embodiment of the watch band of FIG. 9.

FIG. 17 is a front, right and top perspective view of a third embodiment of a watch band.

FIG. 18 is a rear, left and bottom perspective view of the third embodiment of the watch band of FIG.17.

(Continued)

(51) **LOC (14) Cl.** **11-01**
(52) **U.S. Cl.**
USPC **D11/3**
(58) **Field of Classification Search**
USPC D11/1-18, 86, 97, 94; D10/30-32, 38;
D14/344

(Continued)

(56) **References Cited**

U.S. PATENT DOCUMENTS

D240,368 S * 6/1976 Button D11/5
D257,333 S * 10/1980 Hofman D11/3

(Continued)

FOREIGN PATENT DOCUMENTS

IN 224830-0001 * 12/2010

OTHER PUBLICATIONS

Nereides Compatible with Apple Watch Band Series, available Aug. 15, 2022, online, site visited Feb. 7, 2022. Available online, URL:

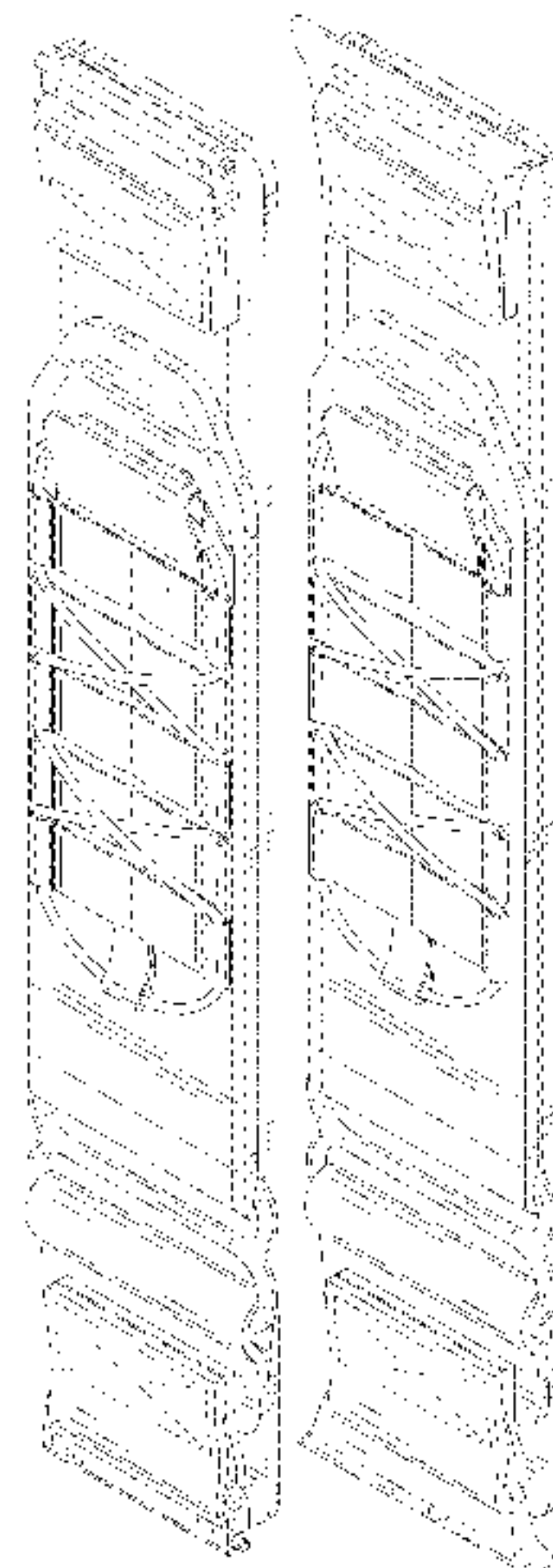

FIG. 19 is a front elevation view of the third embodiment of the watch band of FIG. 17.

FIG. 20 is a rear elevation view of the third embodiment of the watch band of FIG. 17.

FIG. 21 is a left side elevation view of the third embodiment of the watch band of FIG. 17.

FIG. 22 is a right side elevation view of the third embodiment of the watch band of FIG. 17.

FIG. 23 is a top plan elevation view of the third embodiment of the watch band of FIG. 17; and,

FIG. 24 is a bottom plan elevation view of the third embodiment of the watch band of FIG. 17.

The broken lines depict portions of the watch band that form no part of the claimed design.

1 Claim, 24 Drawing Sheets

(58) **Field of Classification Search**

CPC A44C 5/00; A44C 5/0007; A44C 5/0053; A44C 5/0061; A44C 5/0069; A44C 5/0076; A44C 5/02; A44C 5/027; A44C 5/107; A44C 5/12; A44C 5/14; A44C 5/16; A44C 5/18; A44C 5/185; A44C 11/00; A44C 13/00

See application file for complete search history.

(56)

References Cited

U.S. PATENT DOCUMENTS

| | | | | | | |
|--------------|----|---|---------|----------------|-------|-----------------------|
| D341,101 | S | * | 11/1993 | Andrew | | D11/3 |
| D390,800 | S | * | 2/1998 | Yamamoto | | D10/32 |
| D748,527 | S | * | 2/2016 | Akana | | D11/94 |
| D749,460 | S | * | 2/2016 | Akana | | D11/94 |
| D821,912 | S | * | 7/2018 | Ke | | D11/94 |
| D833,909 | S | * | 11/2018 | Akana | | D11/94 |
| D857,545 | S | * | 8/2019 | Akana | | D11/94 |
| D857,546 | S | * | 8/2019 | Akana | | D11/94 |
| D869,323 | S | * | 12/2019 | Akana | | D11/94 |
| D883,840 | S | | 5/2020 | Schowalter | | |
| D920,830 | S | | 6/2021 | Chao | | |
| D920,831 | S | * | 6/2021 | Laucella | | D11/3 |
| 2002/0139142 | A1 | * | 10/2002 | Marandola, Jr. | ... | A44C 17/0216 63/22 |
| 2018/0368538 | A1 | * | 12/2018 | Vanderbilt Kay | | A45F 5/00 |

OTHER PUBLICATIONS

Hemsut Compatible with Apple Watch Band, available Jan. 4, 2022, online, site visited Feb. 7, 2022. Available online, URL: <https://www.amazon.com/Hemsut-Compatible-Rugged-Sports-Replacement/dp/B0B19WZN1G/> (Year: 2022).*

* cited by examiner

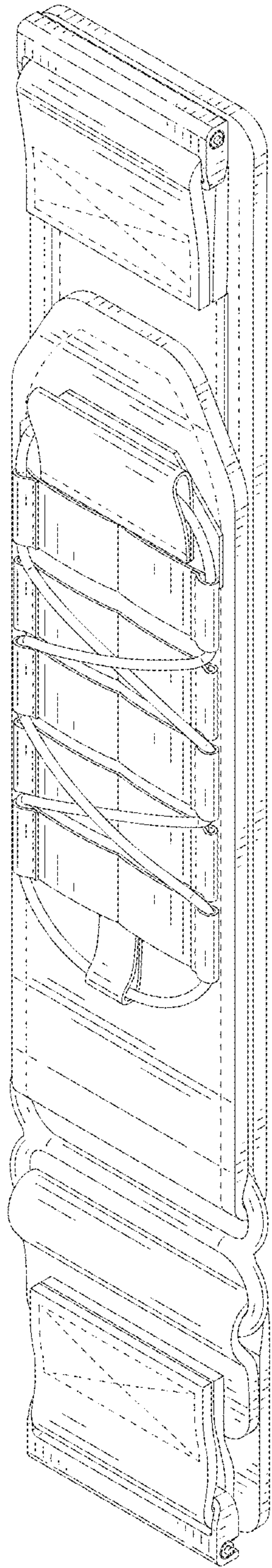

FIG. 1

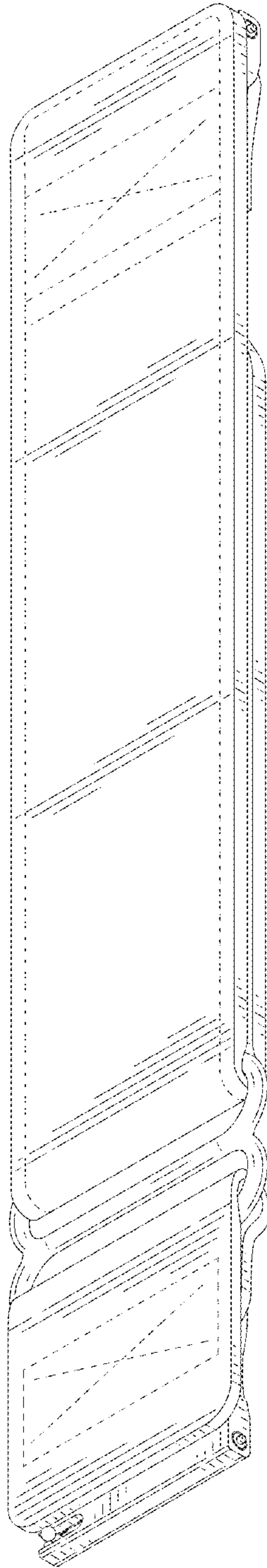

FIG. 2

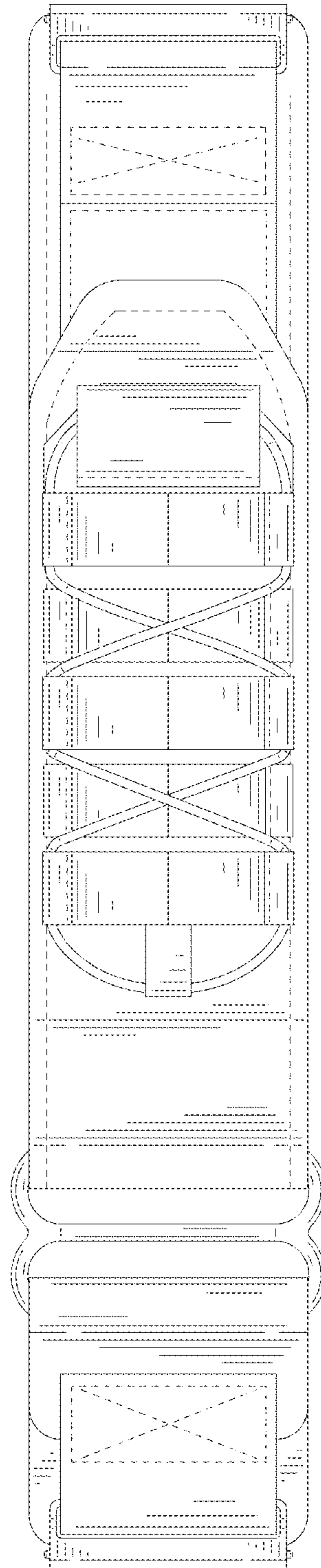

FIG. 3

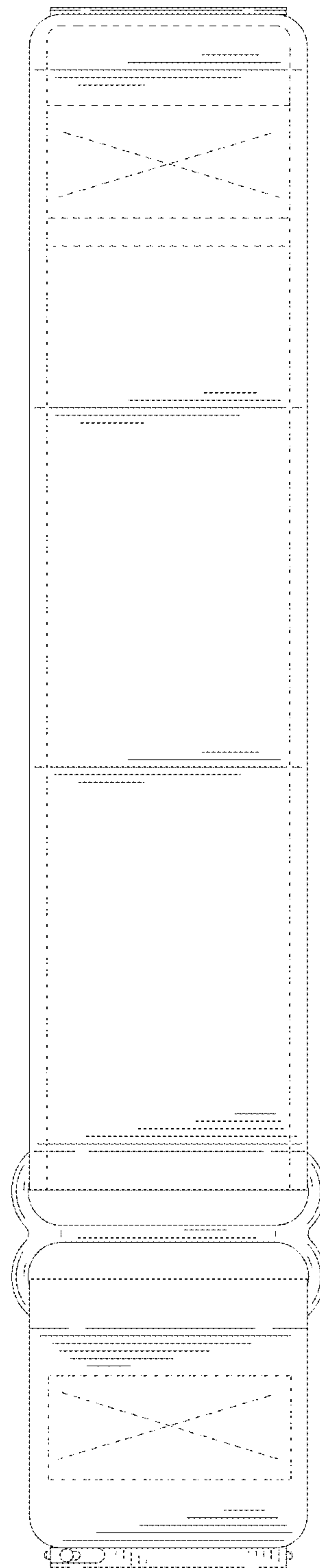

FIG. 4

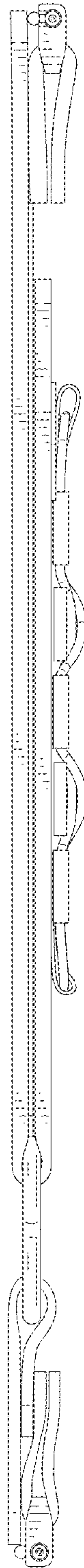

FIG. 5

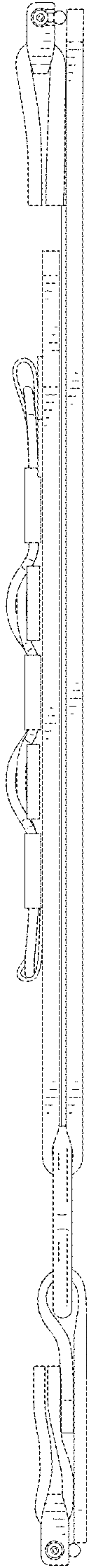

FIG. 6

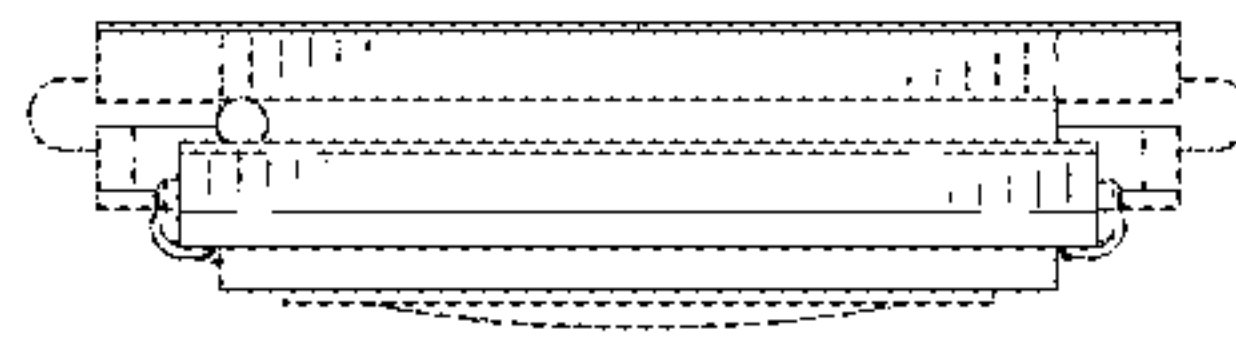

FIG. 7

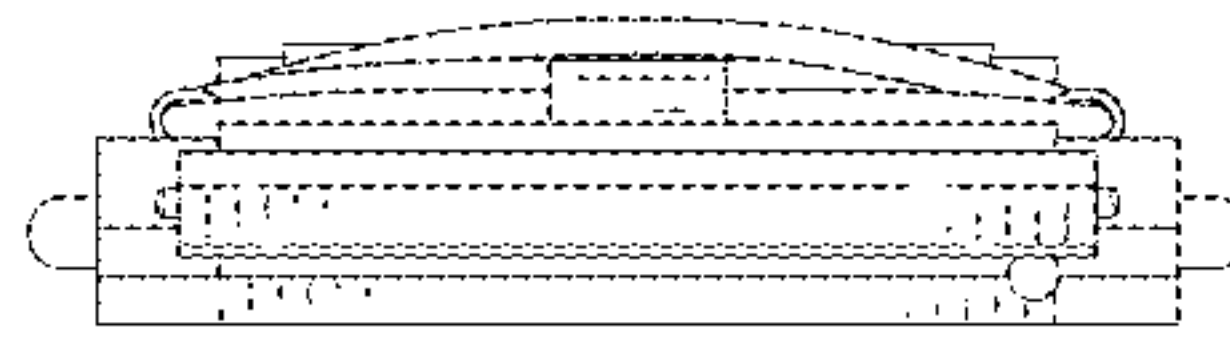

FIG. 8

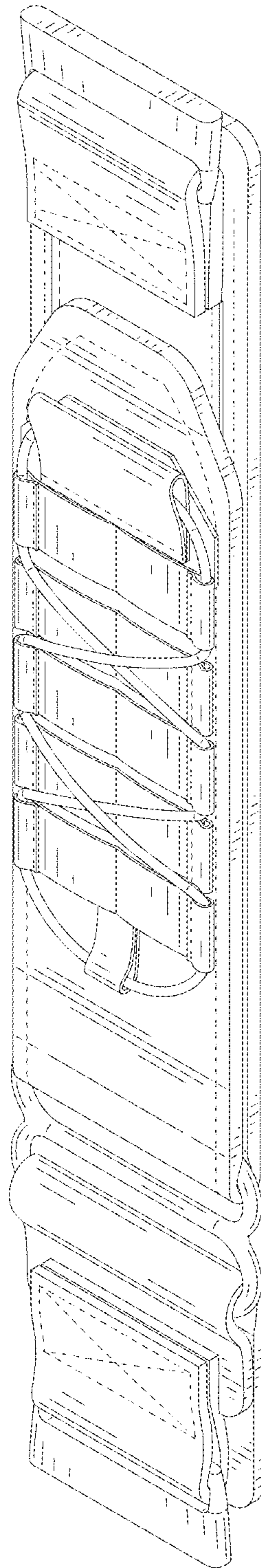

FIG. 9

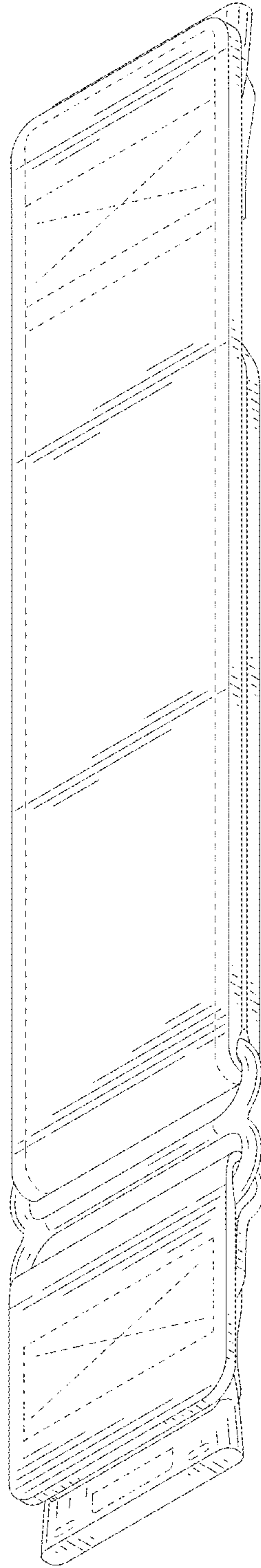

FIG. 10

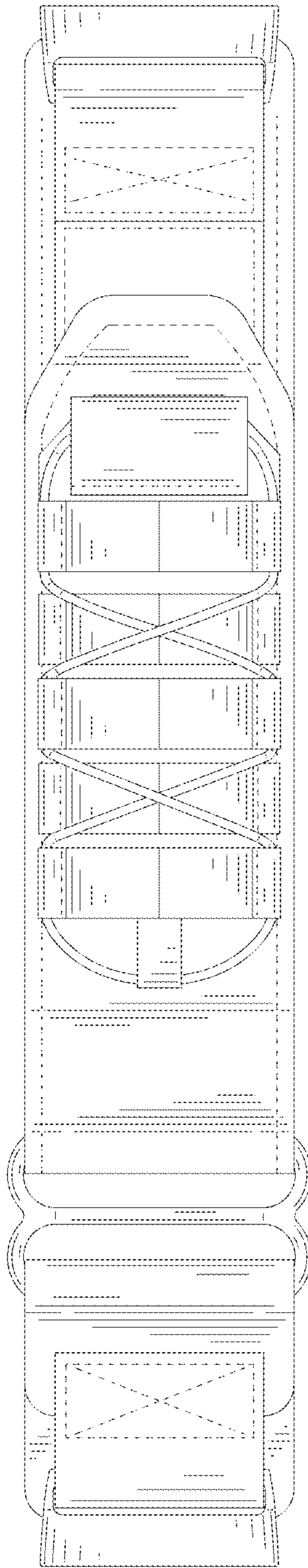

FIG. 11

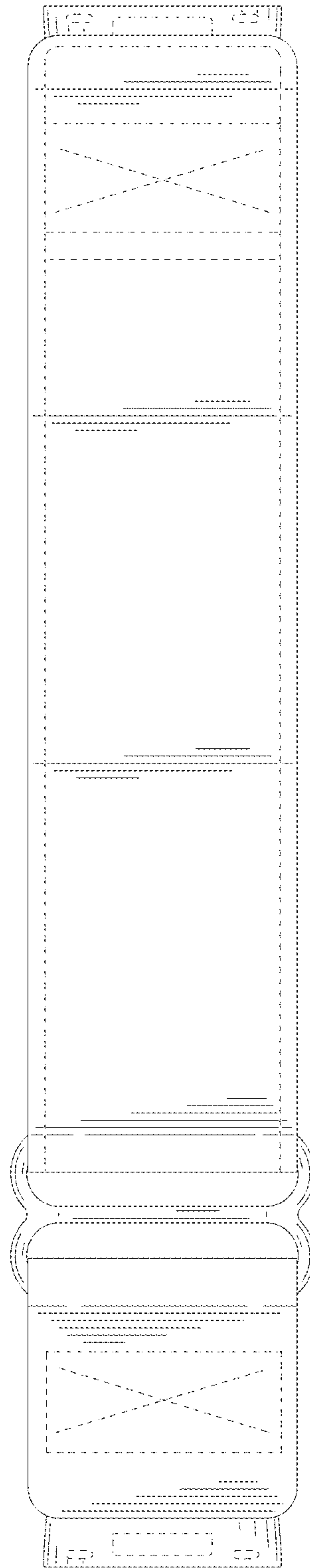

FIG. 12

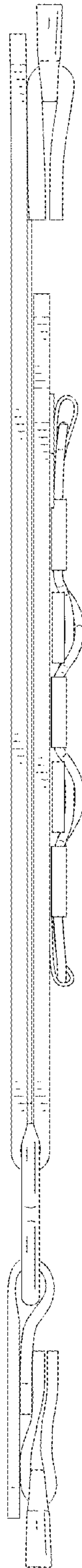

FIG. 13

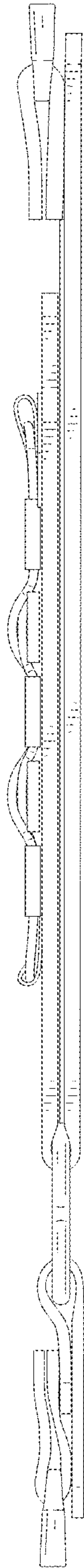

FIG. 14

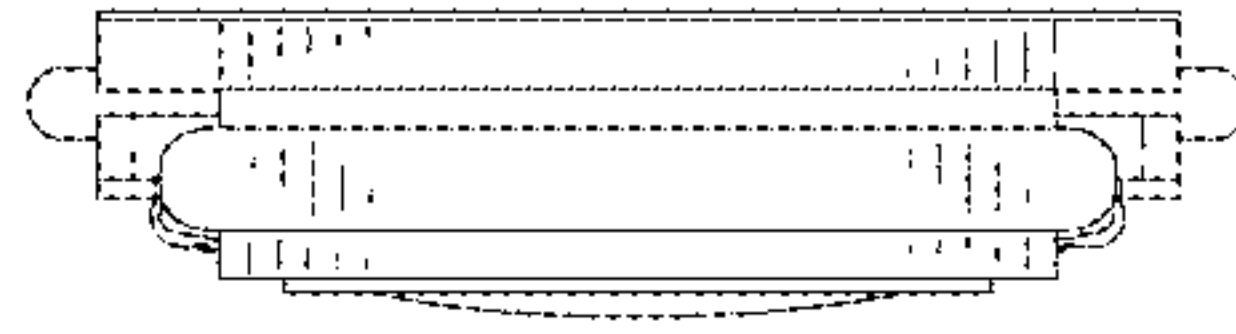

FIG. 15

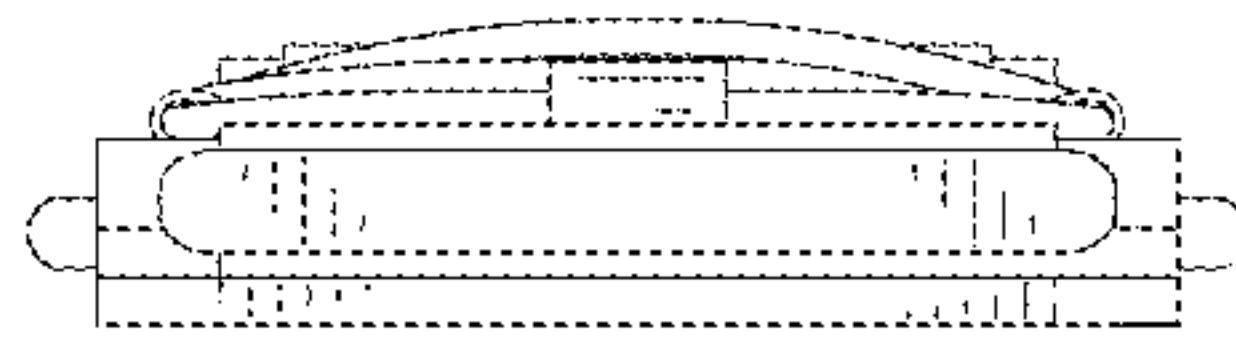

FIG. 16

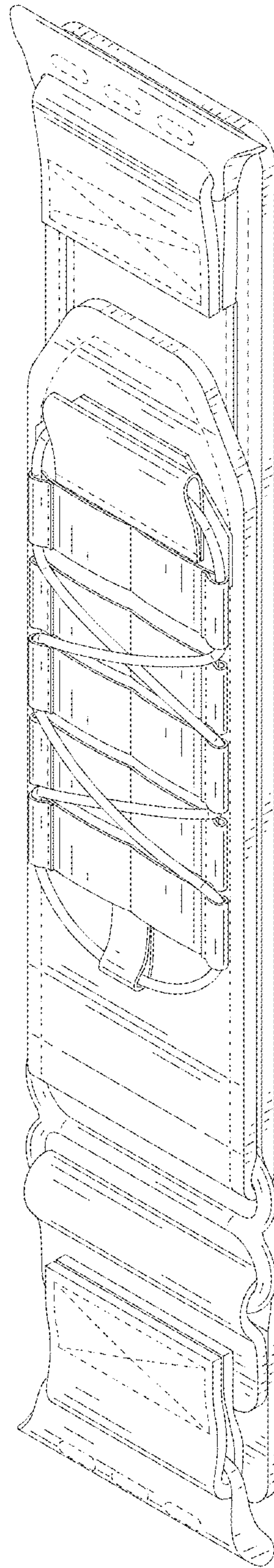

FIG. 17

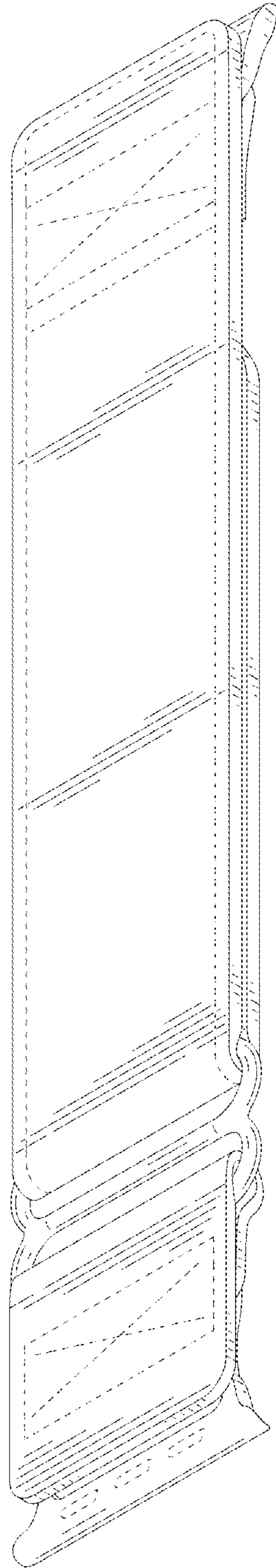

FIG. 18

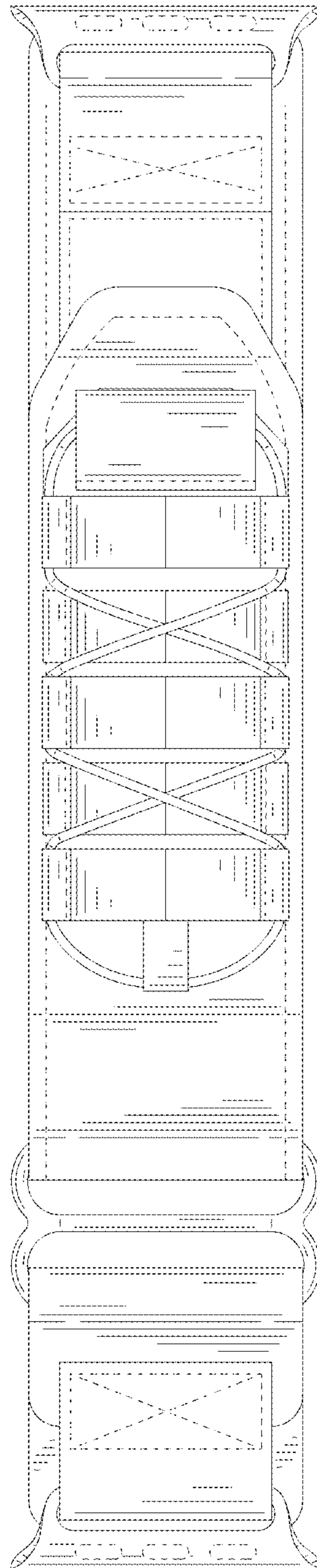

FIG. 19

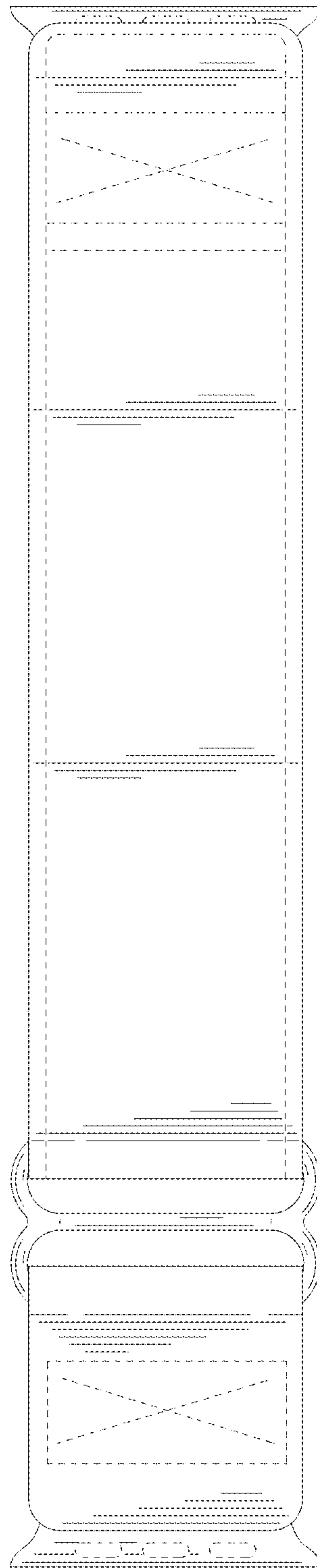

FIG. 20

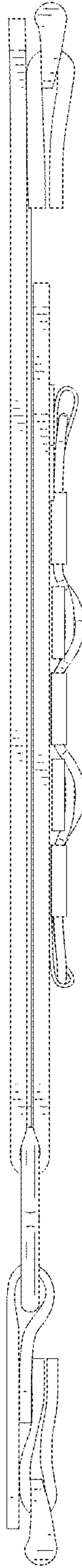

FIG. 21

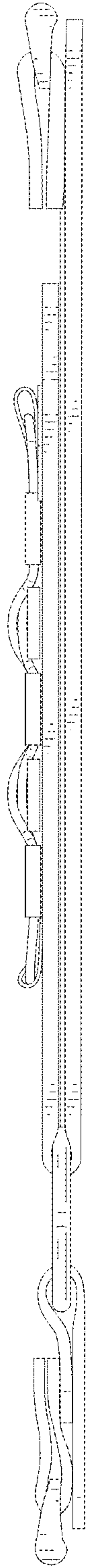

FIG. 22

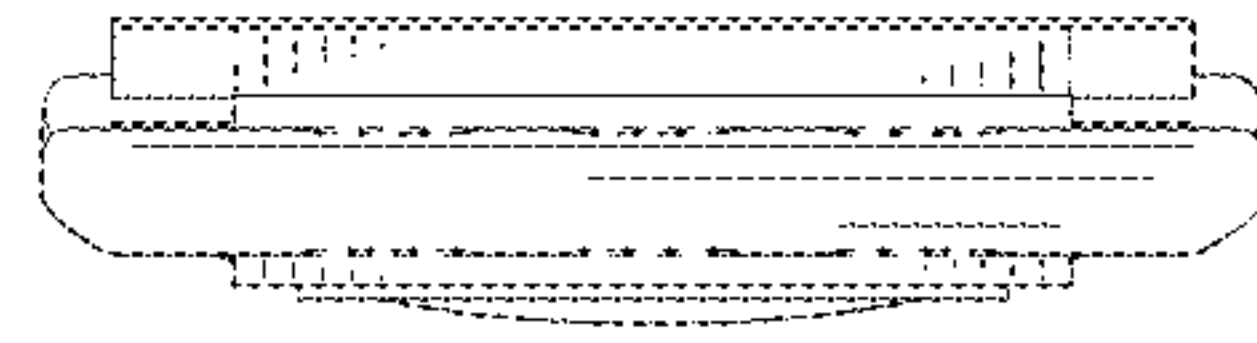

FIG. 23

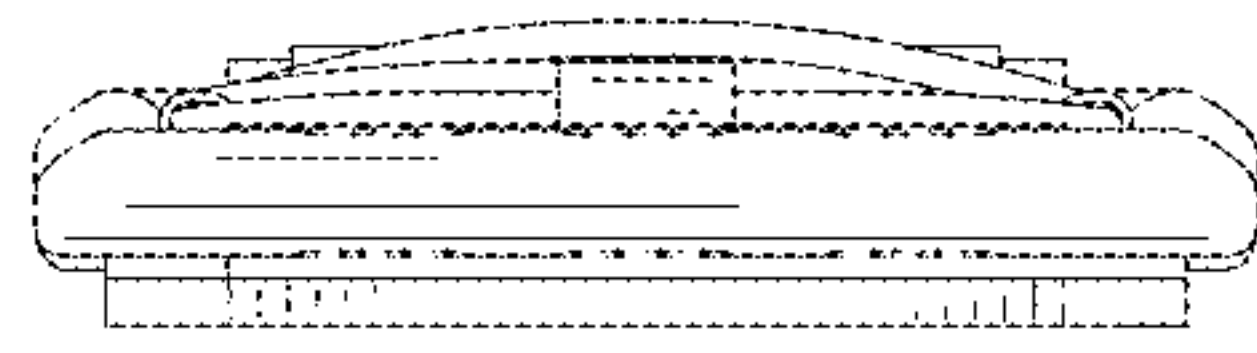

FIG. 24