



US00D986008S

(12) **United States Design Patent** (10) **Patent No.:** **US D986,008 S**
Ames (45) **Date of Patent:** **** *May 16, 2023**

- (54) **TUMBLER**
- (71) Applicant: **Real Value LLC**, Moore, OK (US)
- (72) Inventor: **Micah Ames**, Oklahoma City, OK (US)
- (73) Assignee: **Real Value LLC**, Moore, OK (US)
- (*) Notice: This patent is subject to a terminal disclaimer.
- (**) Term: **15 Years**
- (21) Appl. No.: **29/799,546**
- (22) Filed: **Jul. 15, 2021**

D721,540 S * 1/2015 Grcic D7/511
 D725,965 S * 4/2015 Bo D7/510
 D803,684 S * 11/2017 Seiders D9/449
 (Continued)

OTHER PUBLICATIONS

https://www.amazon.com/Simple-Modern-Flip-Lid-Internally/dp/B07BMG7VCX/ref=sr_1_2?dchild=1&keywords=flip%2Blid%2Btumbler&qid=1598293273&sr=8-2&th=1 Mar. 21, 2018 (Year: 2018).*

(Continued)

Primary Examiner — Jae Liang
Assistant Examiner — Ji Sun Yoon
 (74) *Attorney, Agent, or Firm* — Hall Estill Law Firm;
 Michael H. Smith

Related U.S. Application Data

- (63) Continuation of application No. 29/690,671, filed on May 9, 2019, now Pat. No. Des. 927,935.
- (51) **LOC (14) Cl.** **07-01**
- (52) **U.S. Cl.**
USPC **D7/510; D7/511**
- (58) **Field of Classification Search**
USPC D7/507, 509, 510, 511, 529, 531, 532, D7/523, 533, 534, 535, 536, 392.1, 296.1, D7/396.2, 300.1, 608; D3/202; D26/9
CPC A47G 19/22; A47G 19/2288; A47G 19/2205; A47J 41/0077; A47J 41/0088
See application file for complete search history.

(57) **CLAIM**

The ornamental design for a tumbler, as shown and described.

DESCRIPTION

FIG. 1 is a top, perspective view showing a first embodiment of my new design for a tumbler.
 FIG. 2 is a bottom, perspective view of FIG. 1.
 FIG. 3 is a front side elevation view of FIG. 1.
 FIG. 4 is a rear side elevation view of view of FIG. 1.
 FIG. 5 is a left side elevation view of FIG. 1.
 FIG. 6 is a right side elevation view of FIG. 1.
 FIG. 7 is a top view of FIG. 1.
 FIG. 8 is a bottom view of FIG. 1.
 FIG. 9 is a top, perspective view showing a second embodiment of my new design for a tumbler.
 FIG. 10 is a bottom, perspective view of FIG. 9.
 FIG. 11 is a front side elevation view of FIG. 9.
 FIG. 12 is a rear side elevation view of view of FIG. 9.
 FIG. 13 is a left side elevation view of FIG. 9.
 FIG. 14 is a right side elevation view of FIG. 9.
 FIG. 15 is a top view of FIG. 9; and,
 FIG. 16 is a bottom view of FIG. 9.

(56) **References Cited**

U.S. PATENT DOCUMENTS

- 4,494,668 A * 1/1985 Lottick A47G 19/2288
215/229
- D485,759 S * 1/2004 Janky D9/449
- D604,103 S * 11/2009 Alviar D7/510
- D608,140 S * 1/2010 Gilbert D7/392.1
- D623,017 S * 9/2010 George D7/510
- D632,132 S * 2/2011 George D7/533
- D643,245 S * 8/2011 Minarsch D7/392.1
- D667,265 S * 9/2012 George D7/396.2
- D717,115 S * 11/2014 Lane D7/511

1 Claim, 14 Drawing Sheets

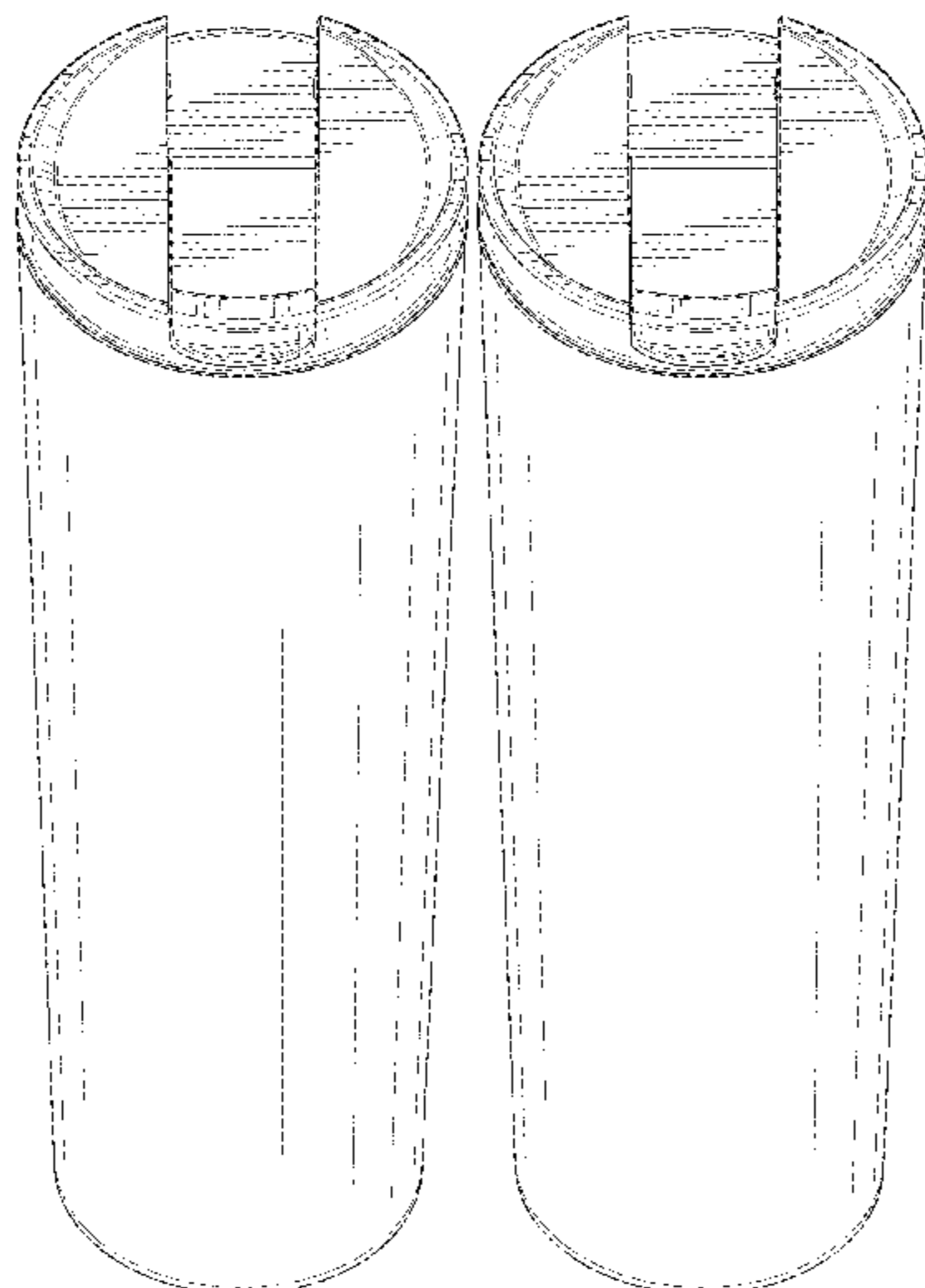

(56)

References Cited

U.S. PATENT DOCUMENTS

D814,240	S *	4/2018	Kabalin	D7/510
D834,882	S *	12/2018	Seiders	D9/449
D836,395	S *	12/2018	Seiders	D7/510
D844,383	S *	4/2019	Seiders	D7/510
D861,415	S *	10/2019	Seiders	D7/392.1
D863,876	S *	10/2019	Alprin	D7/392.1
D886,514	S *	6/2020	Kander	D7/392.1
D891,866	S *	8/2020	Ames	D7/510
D931,051	S *	9/2021	Ames	D7/510
D933,423	S *	10/2021	Ames	D7/510
D934,028	S *	10/2021	Haskins	D7/510
2008/0264959	A1 *	10/2008	Unda	B65D 1/265 220/711
2012/0132658	A1 *	5/2012	Dans	G01K 15/005 220/592.2
2018/0194520	A1 *	7/2018	Lovern	A01N 25/34

OTHER PUBLICATIONS

https://www.amazon.com/Zak-Designs-Aberdeen-Stainless-Insulated/dp/B07NBBKBHF/ref=sr_1_35?crid=2K9DZKQ62VQXY&keywords=slim%2Bflip%2Btumbler&qid=1655246403&srefix=slim%2Bflip%2Caps%2C118&sr=8-35&th=1 May 22, 2020 (Year: 2020).*

* cited by examiner

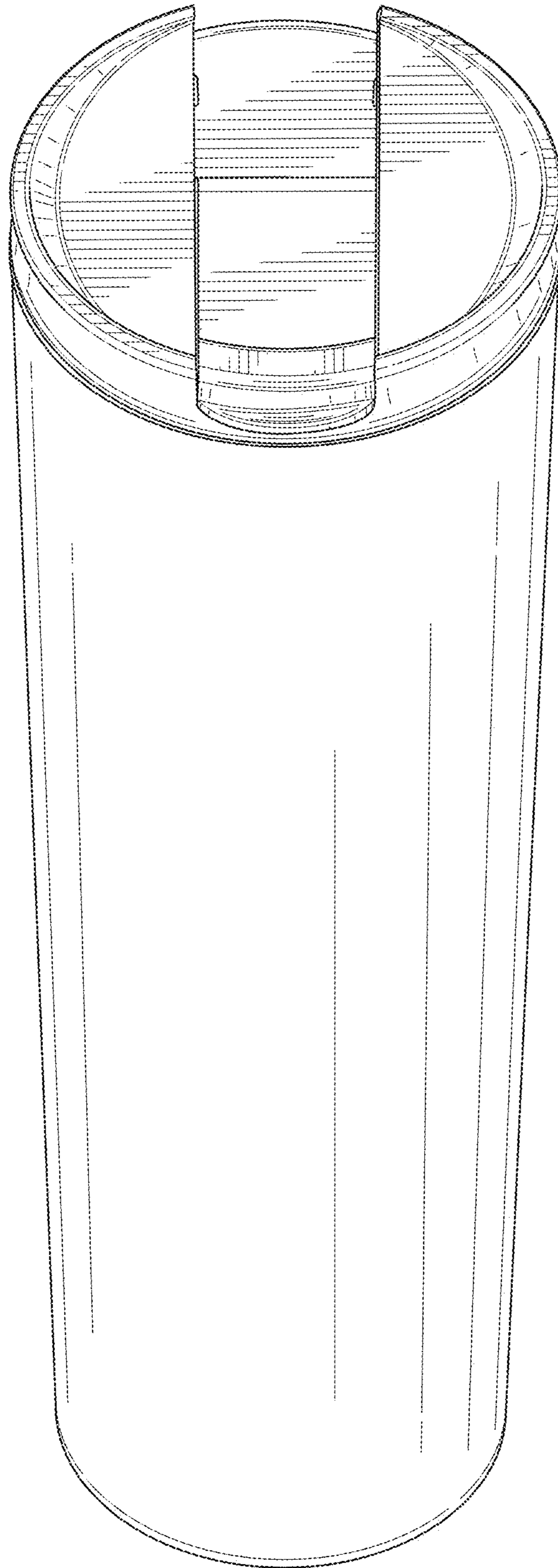

FIG. 1

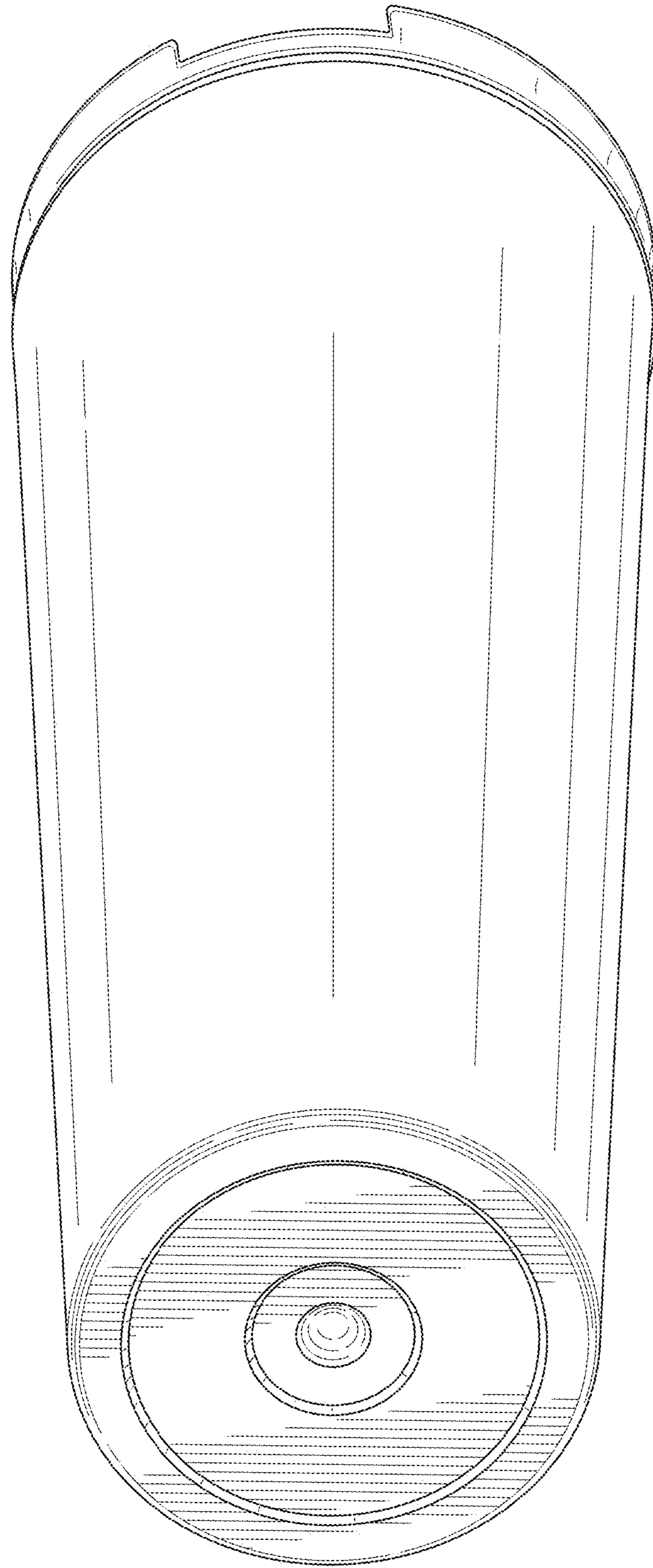

FIG. 2

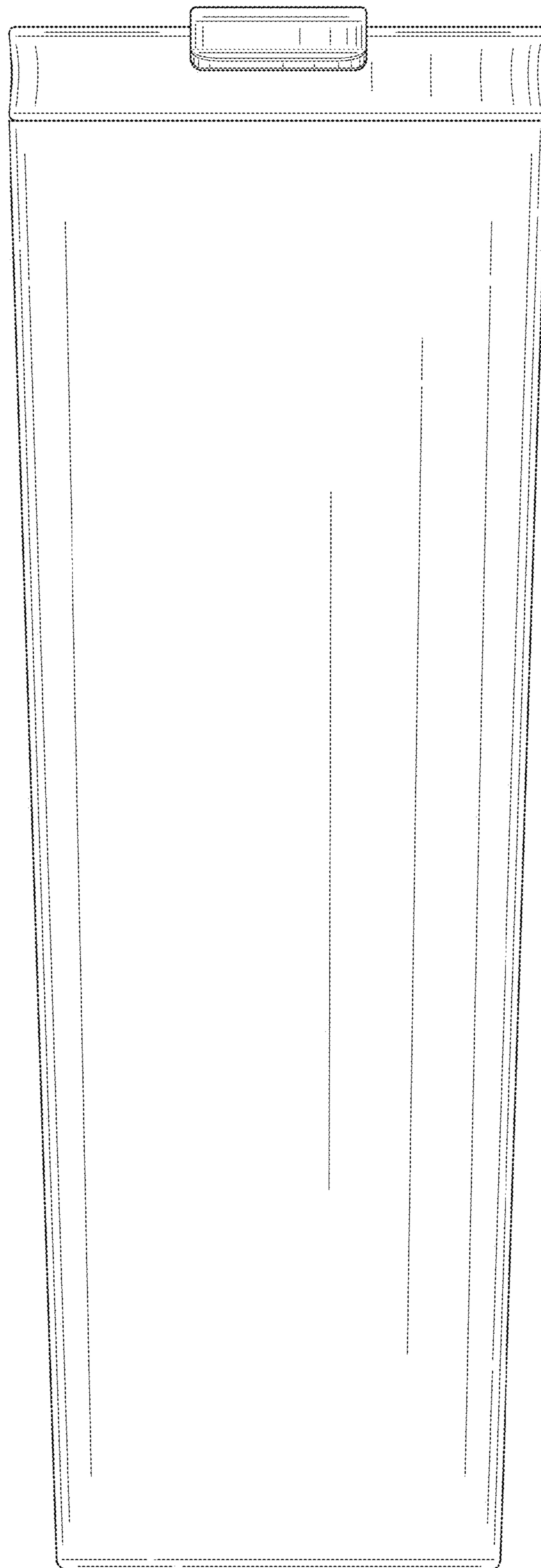

FIG. 3

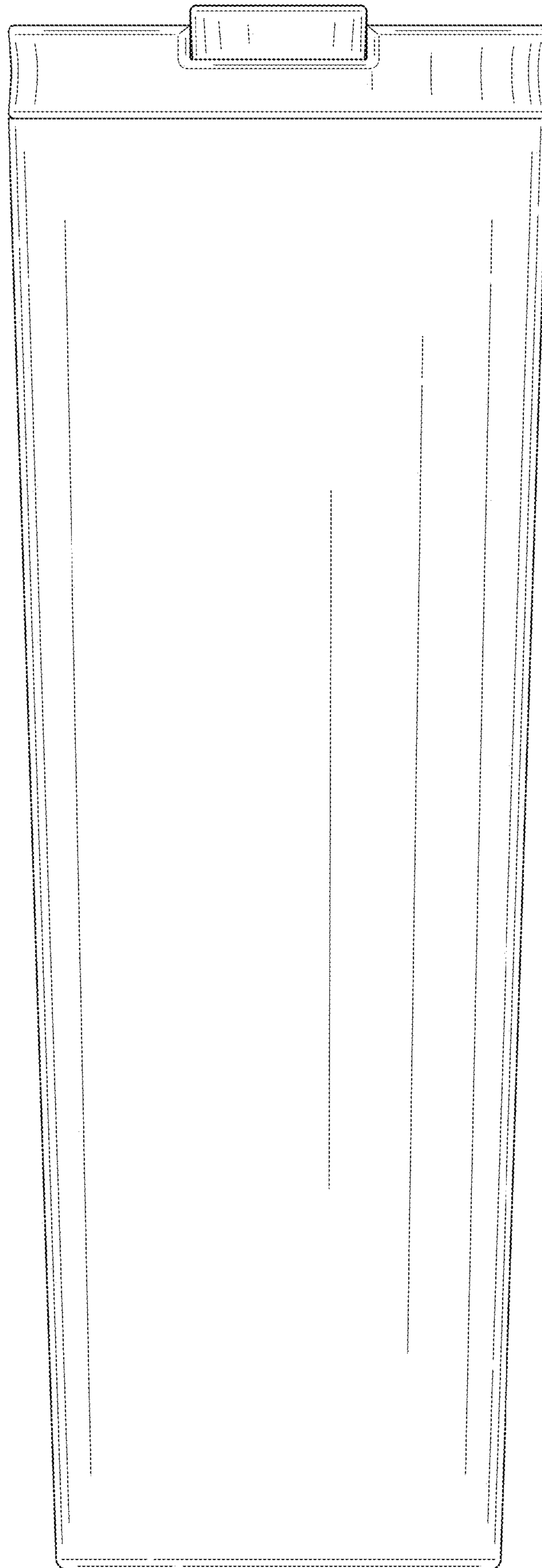

FIG. 4

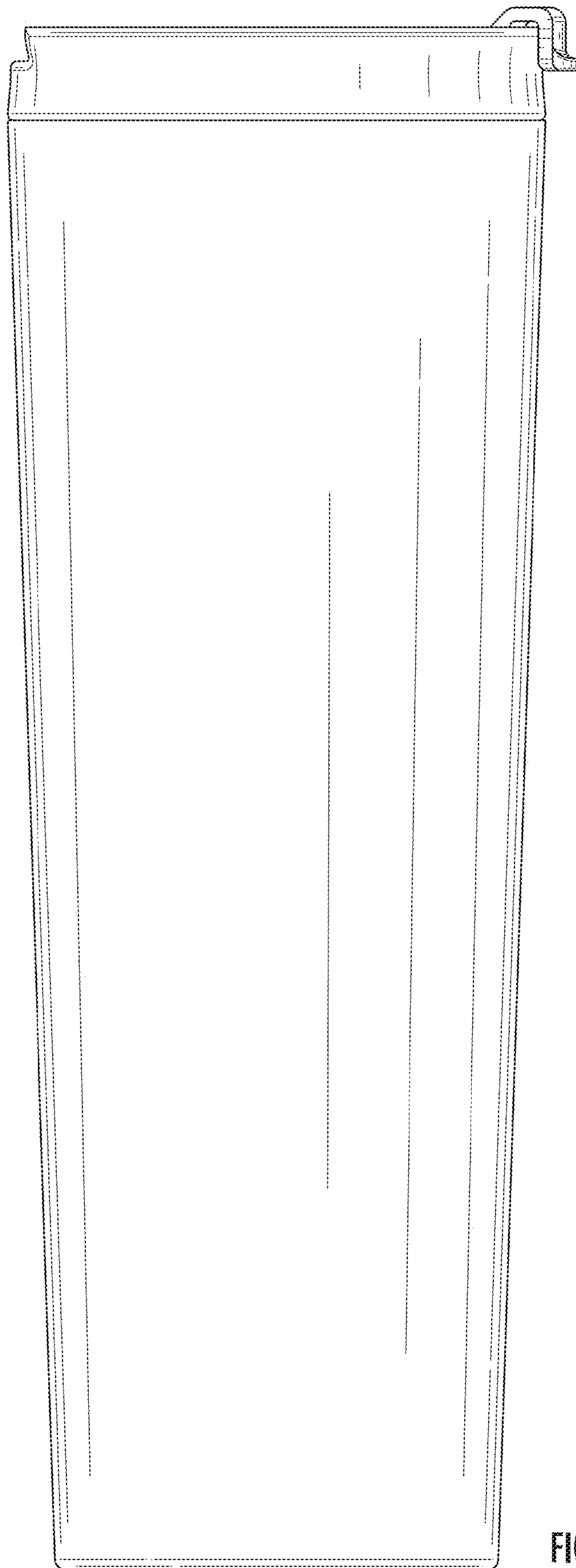

FIG. 5

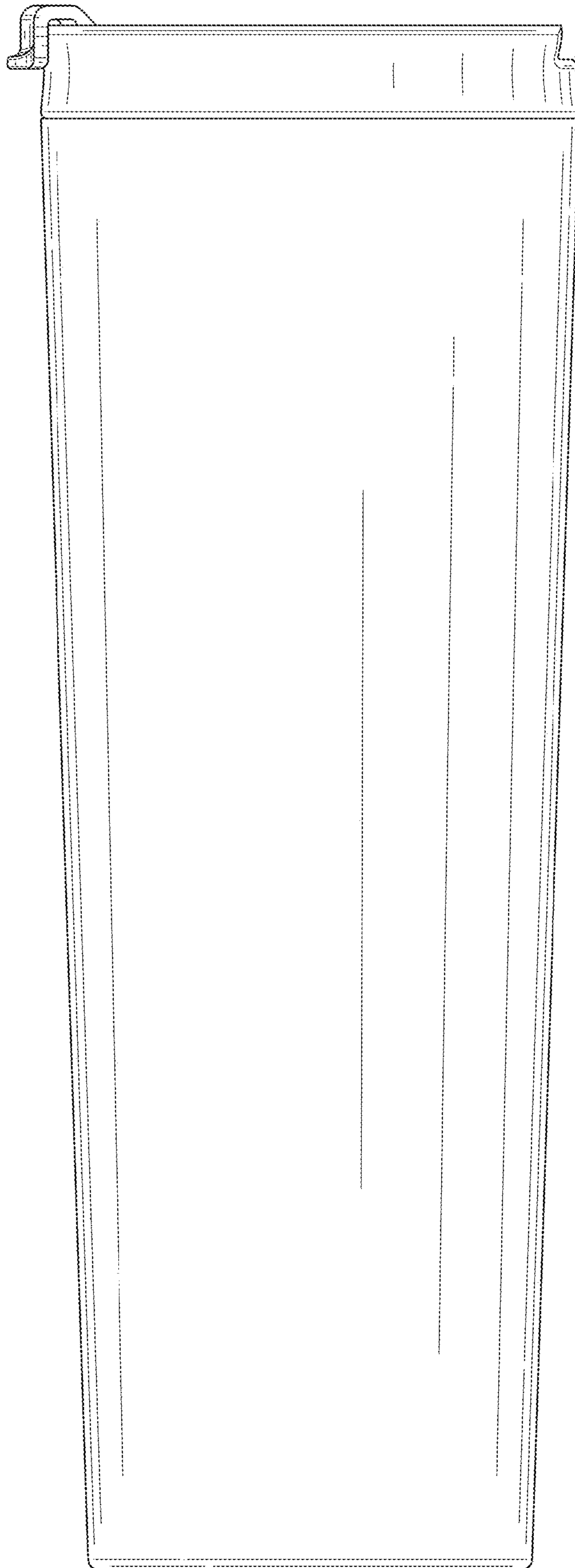

FIG. 6

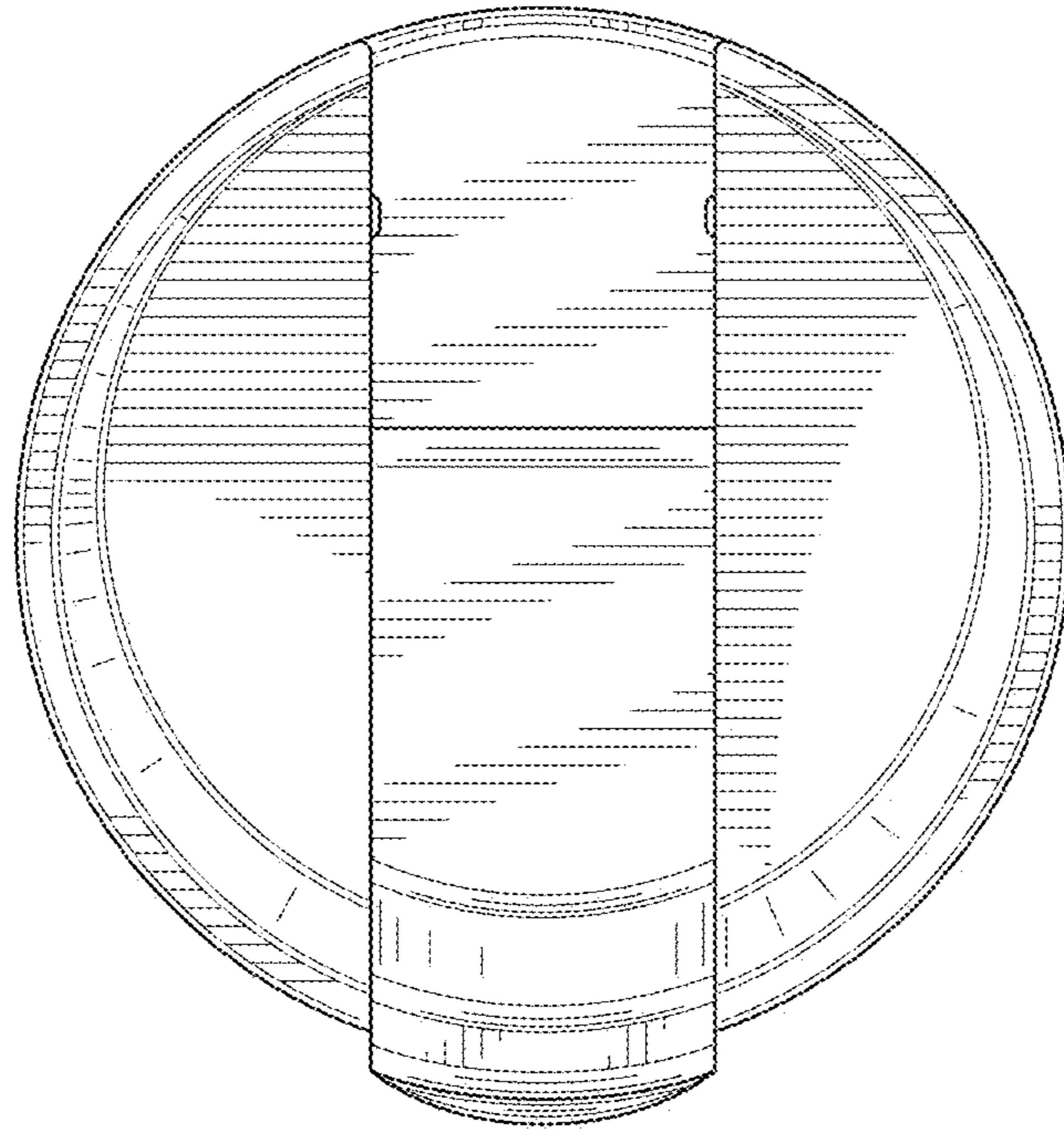

FIG. 7

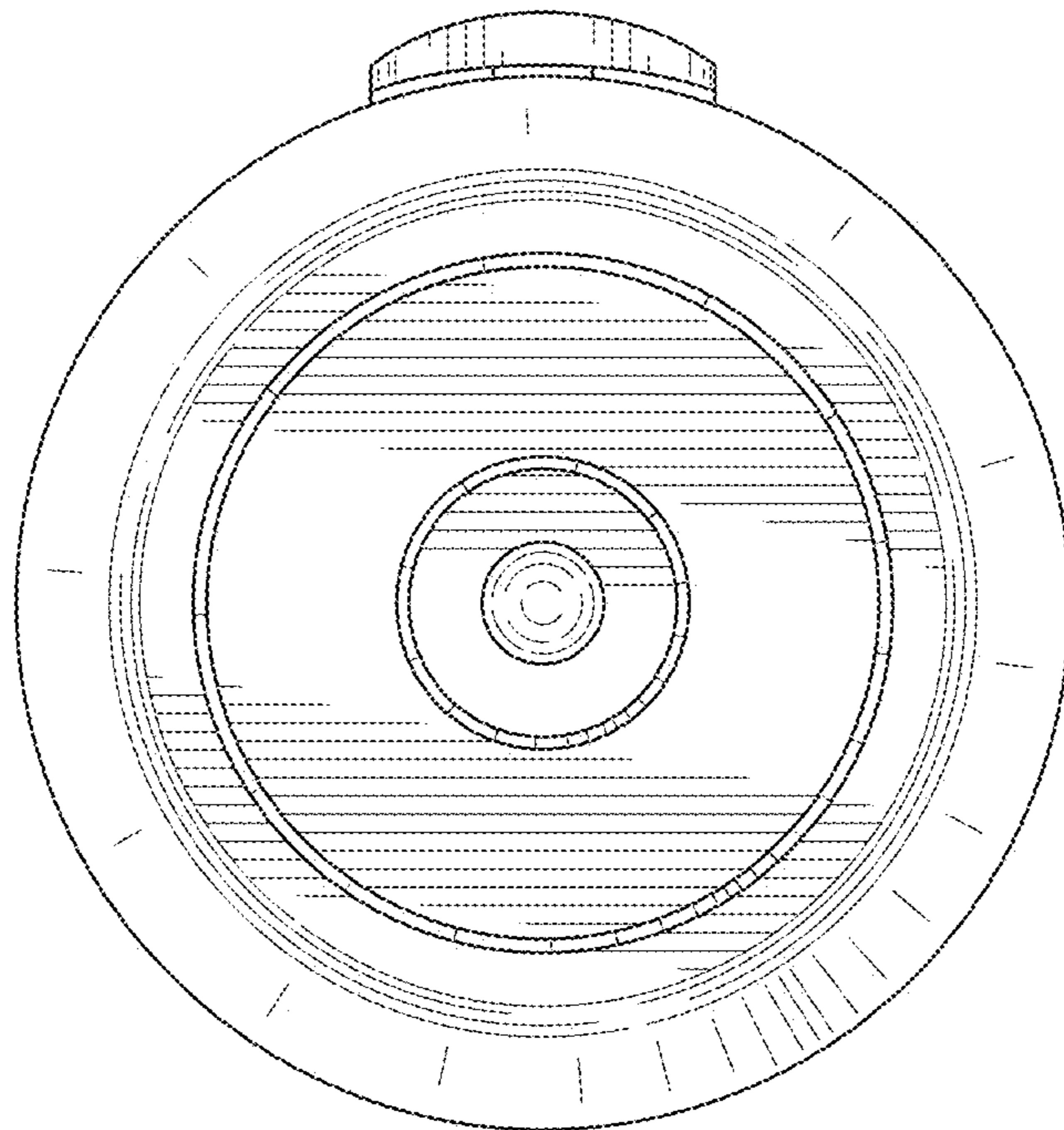

FIG. 8

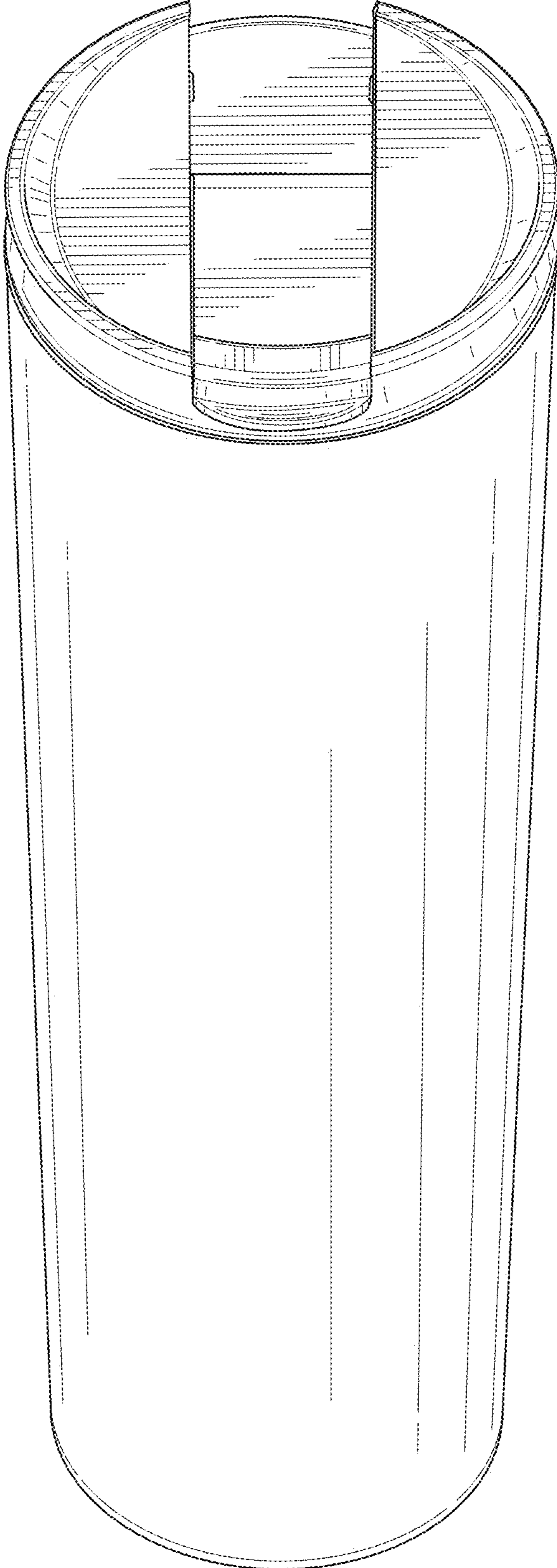

FIG. 9

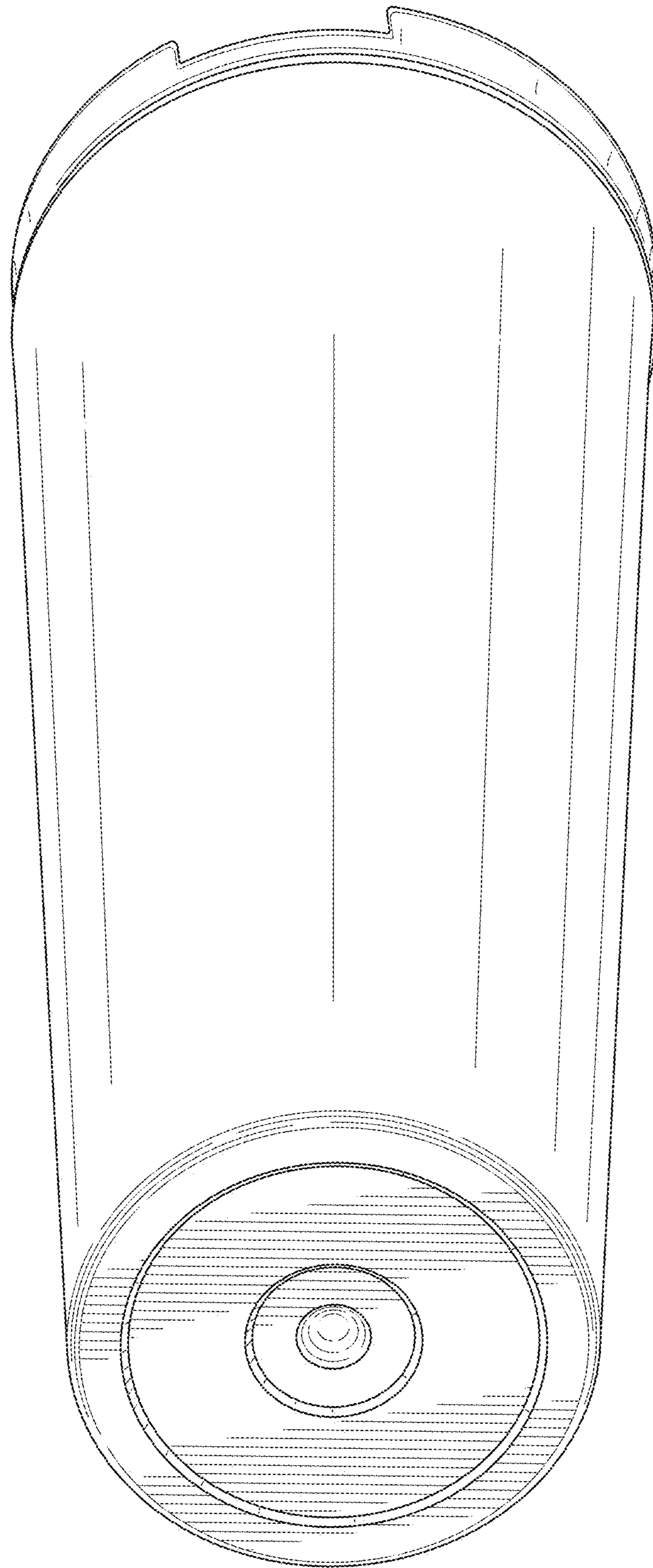

FIG. 10

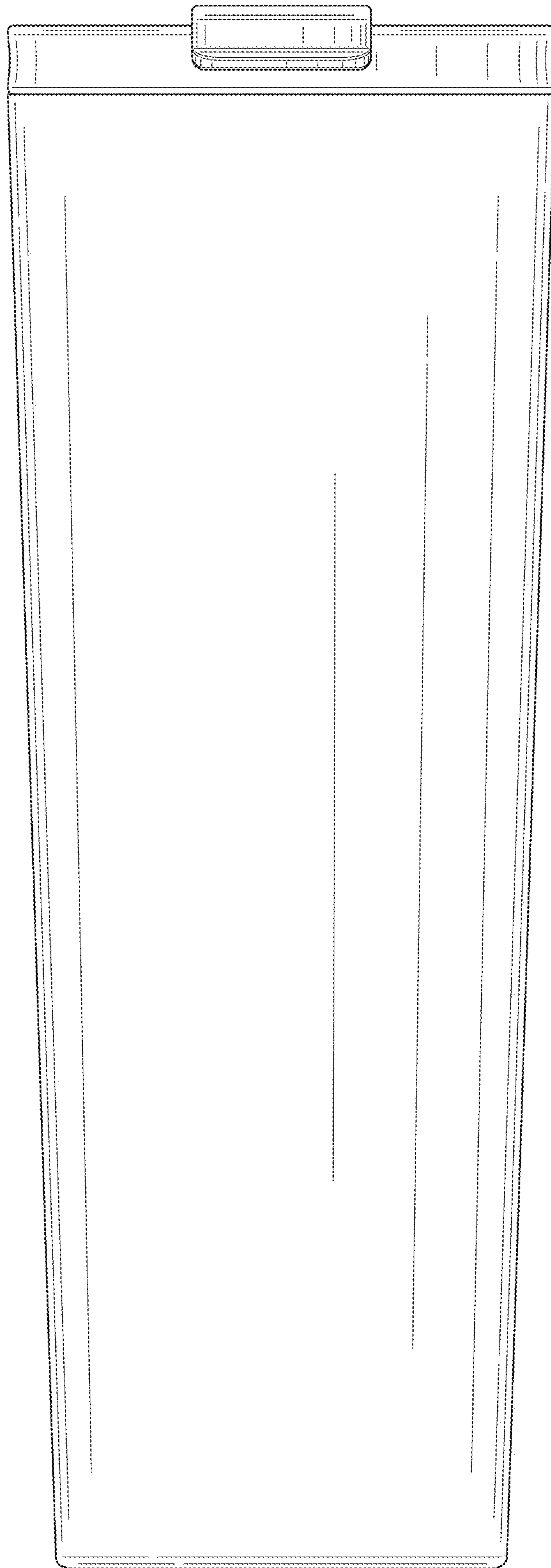

FIG. 11

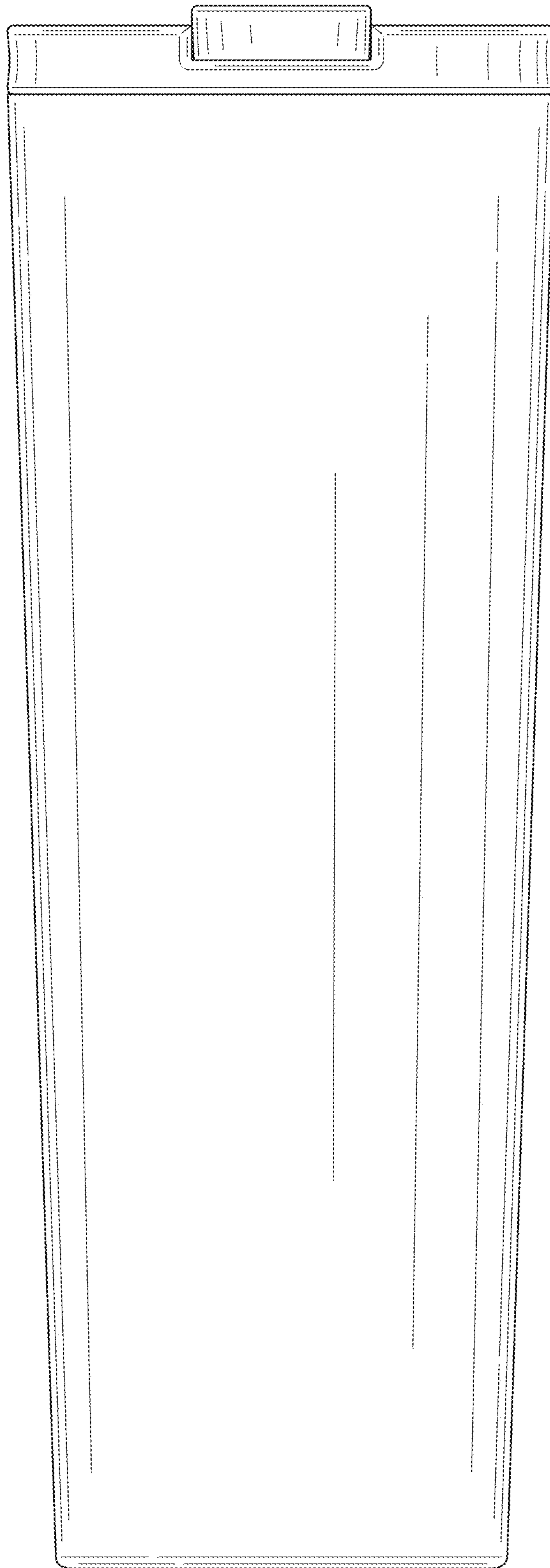

FIG. 12

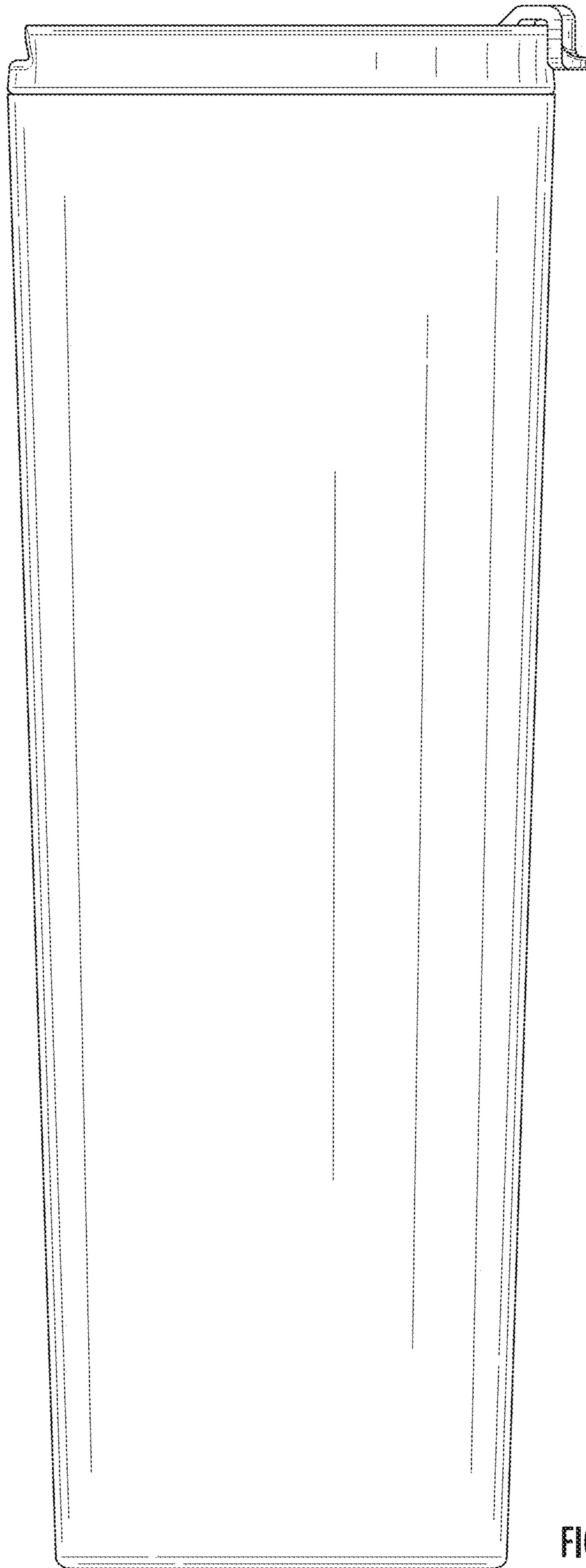

FIG. 13

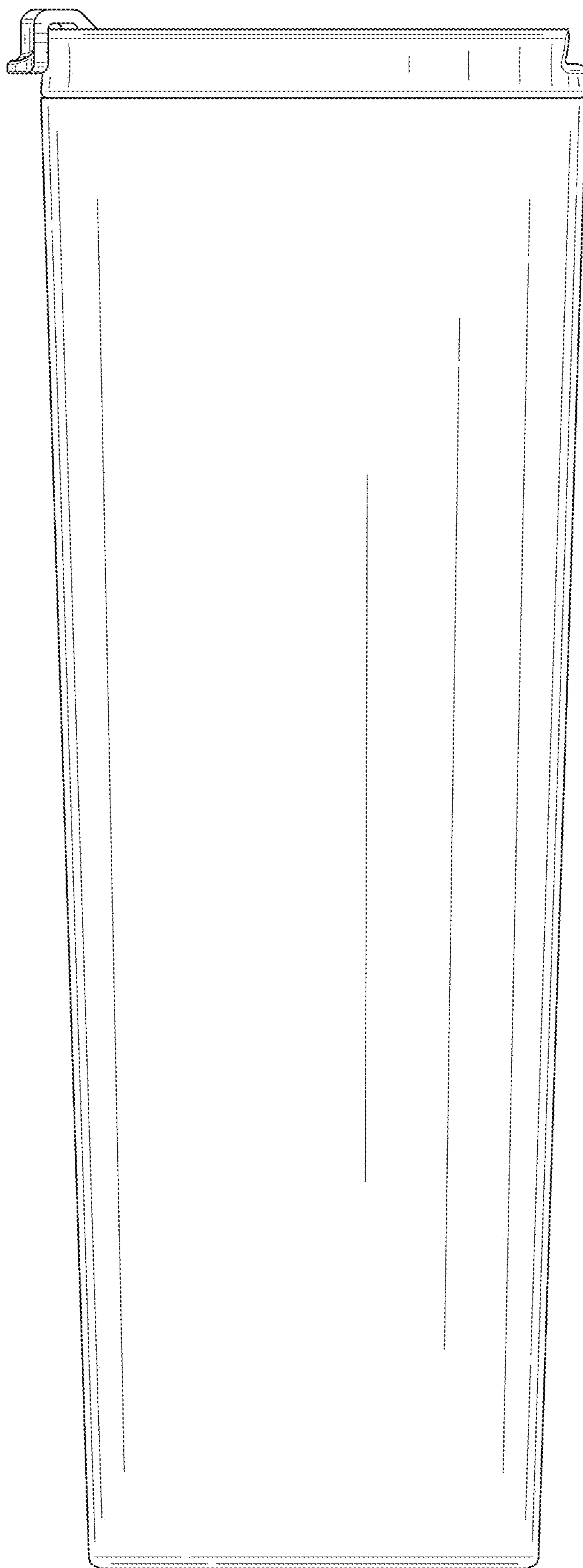

FIG. 14

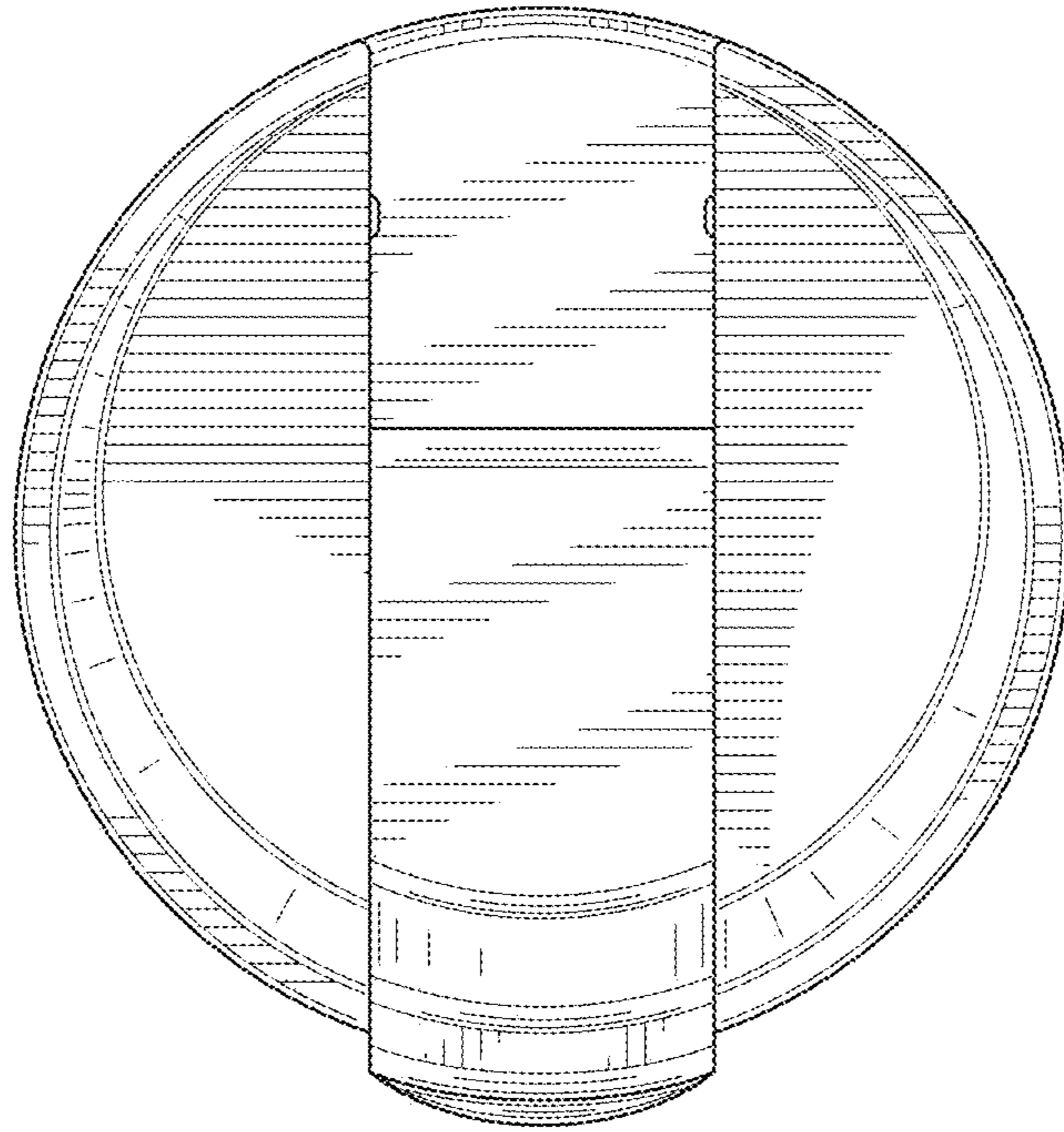

FIG. 15

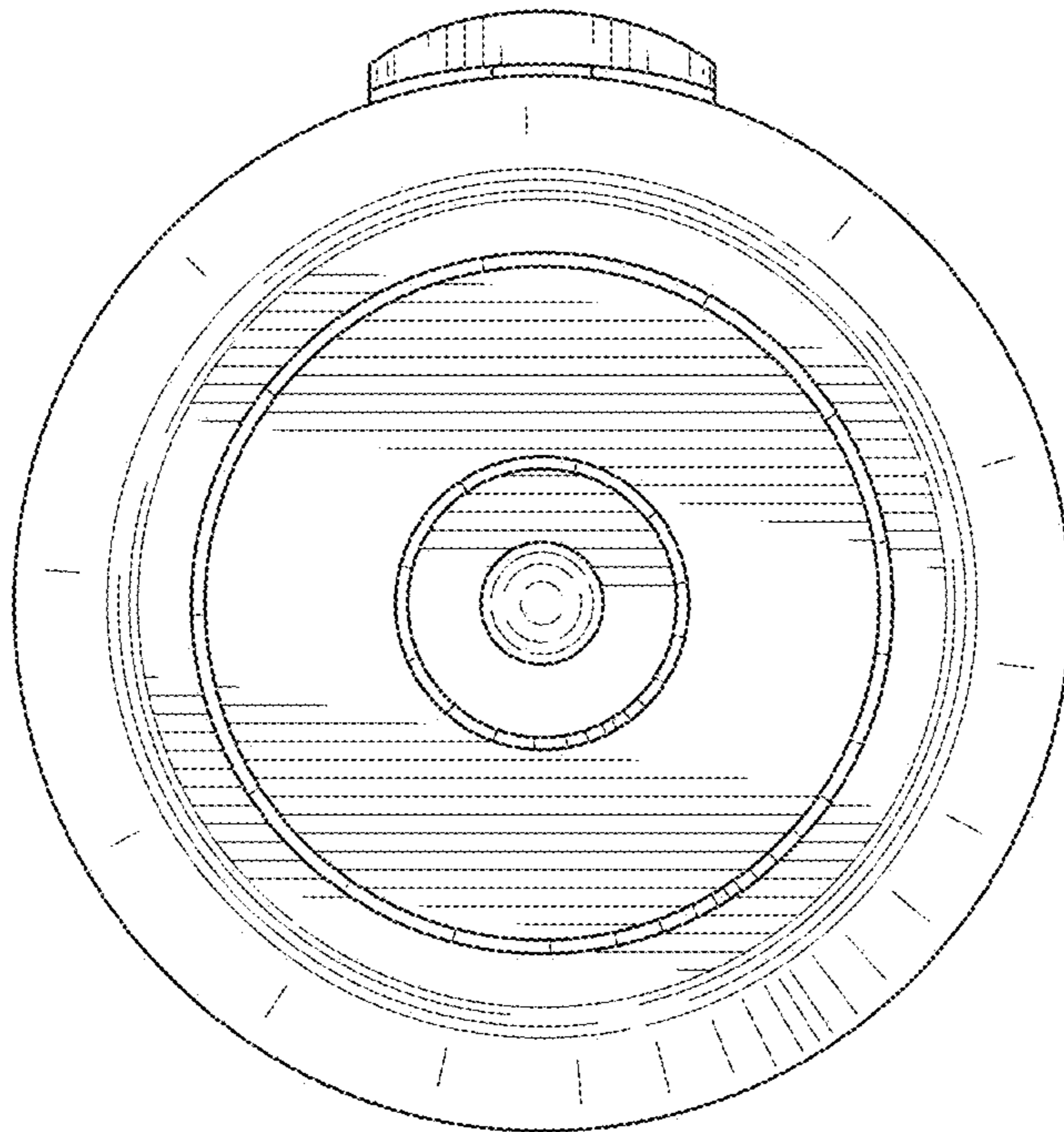

FIG. 16